

LAPPSET®

FITNESS







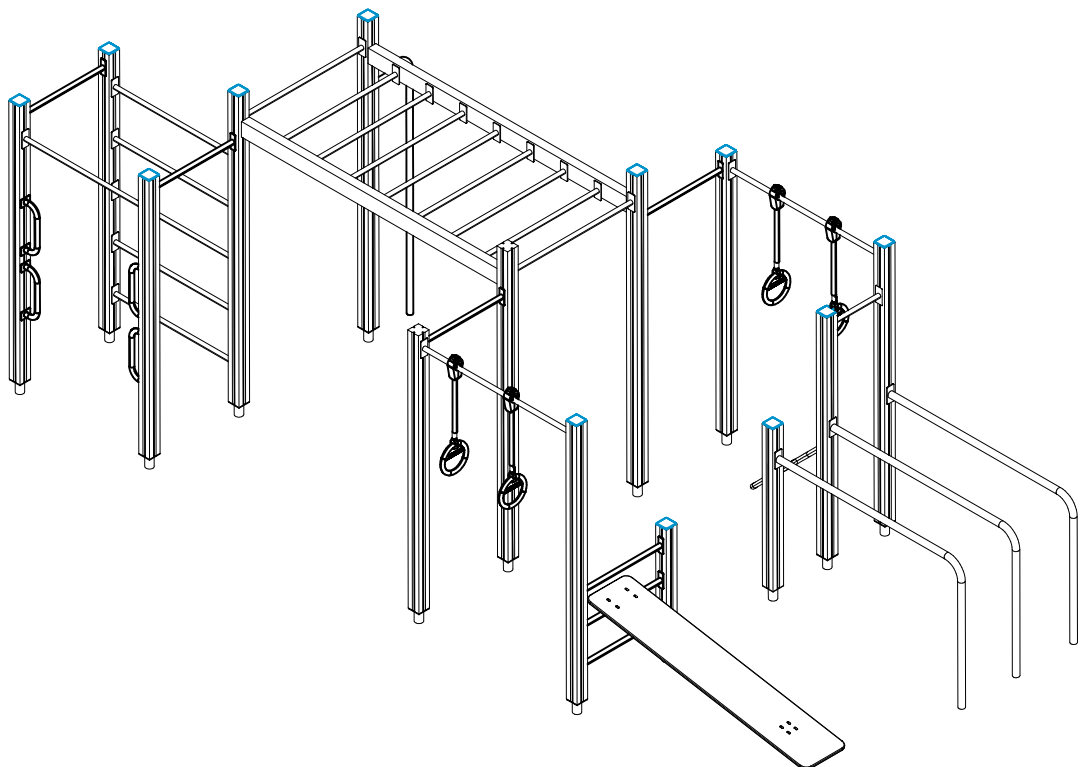



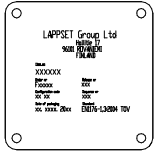
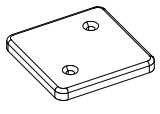

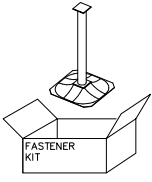

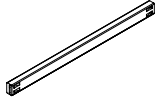
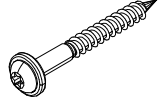
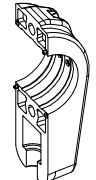
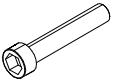
ASENNUSOHJE
MONTERINGSANSVISNING
INSTALLATION INSTRUCTION
AUFBAUANLEITUNG
NOTICE D'INSTALLATION

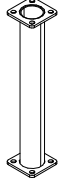
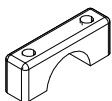
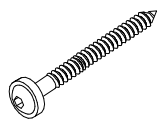
DATE: 18.2.2021

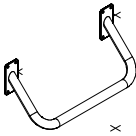
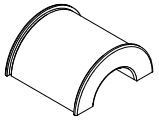
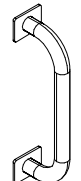
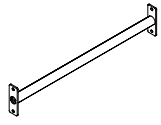
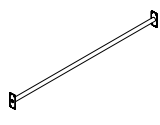
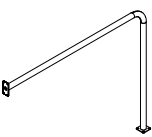
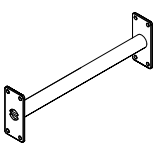
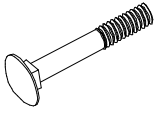
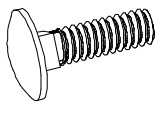
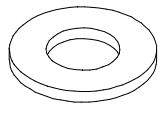
Q14764-2

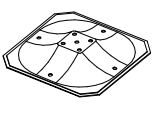
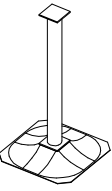
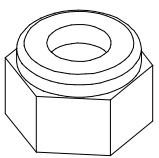
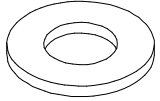
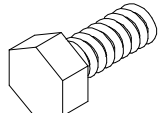
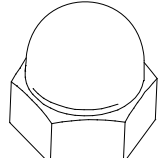
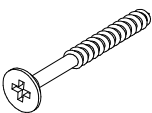
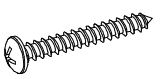

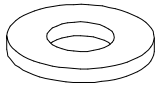
DATE: 18.2.2021

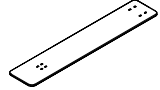
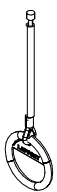
701401-604	PCS 1		L 1250	702286	PCS 1		65x65	706481-701	PCS 12		83x83x10	706484-604	PCS 7		93x93x2150	706511-604	PCS 1		93x93x1870	706531	PCS 14		FASTENER KIT
706669-604	PCS 4		93x93x2400	706894-604	PCS 1		L 950	707294-604	PCS 2		70x120x2304	900240	PCS 36		Ø8x70	902195	PCS 8		150x50x50	902232	PCS 4		M10x55
902233	PCS 4		M10x30	902272	PCS 3		90x90x450	902454	PCS 2			903093	PCS 20		Ø8x90	905817-215	PCS 1		2626x386x60	905838-215	PCS 15		L 1060
905934-215	PCS 1			906006	PCS 8		Ø64/36,4x59	906635-215	PCS 4			907694-215	PCS 7		L 704	908017-215	PCS 2		L1315	908019-215	PCS 3		1500x1200
908062-215	PCS 1		L 420	909107	PCS 4		M12x80	909109	PCS 4		M12x40	909256	PCS 176		Ø16/8.4	909511	PCS 14		90x90x650	909519	PCS 14		50x380x380
909521	PCS 1			909637	PCS 12		M10	909638	PCS 24		Ø20/10.5	909639	PCS 12		M10x25	909644	PCS 8		M12	980107	PCS 24		Ø6x60
980114	PCS 4		Ø4x20	980123	PCS 164		Ø7x60	980154	PCS 32		Ø24/13	980161	PCS 8		M10	P01987	PCS 1		2000x380	P10375	PCS 4		Ø16x764

— EN/AS Impact Area 57.3 m²

- - - Falling Space 57.3 m²

Max Falling Height 0000 mm

Grid size = 1000 mm

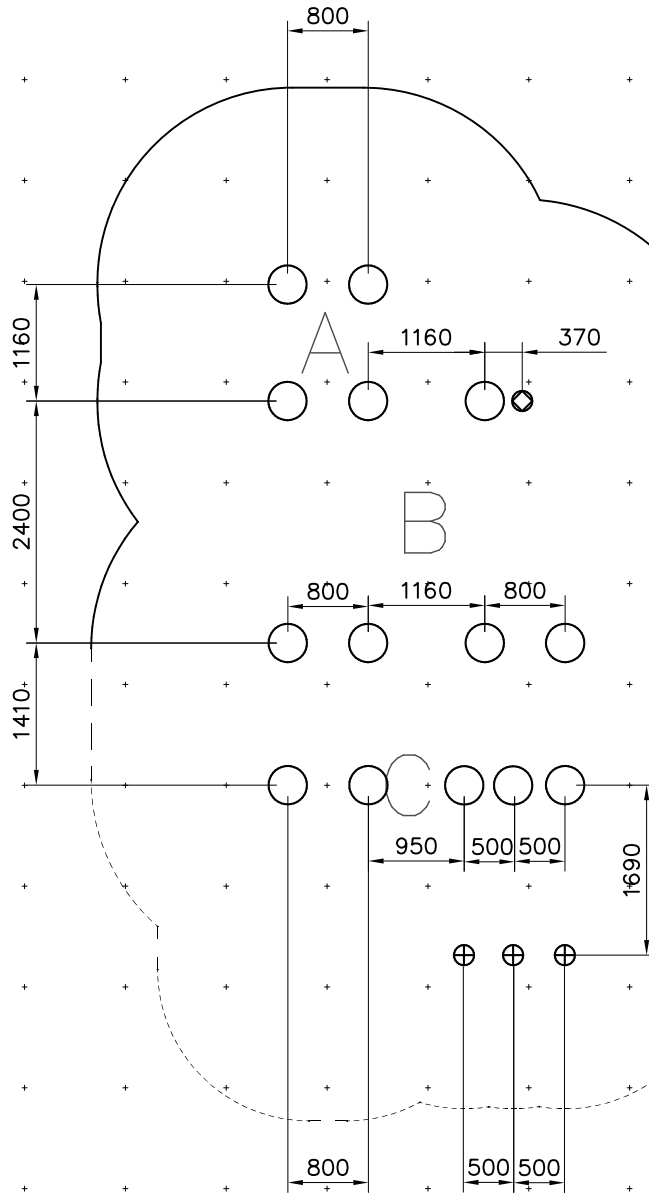
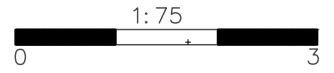

- EN/AS Impact Area 57.3 m²
- - - Falling Space 57.3 m²
Max Falling Height 0000 mm

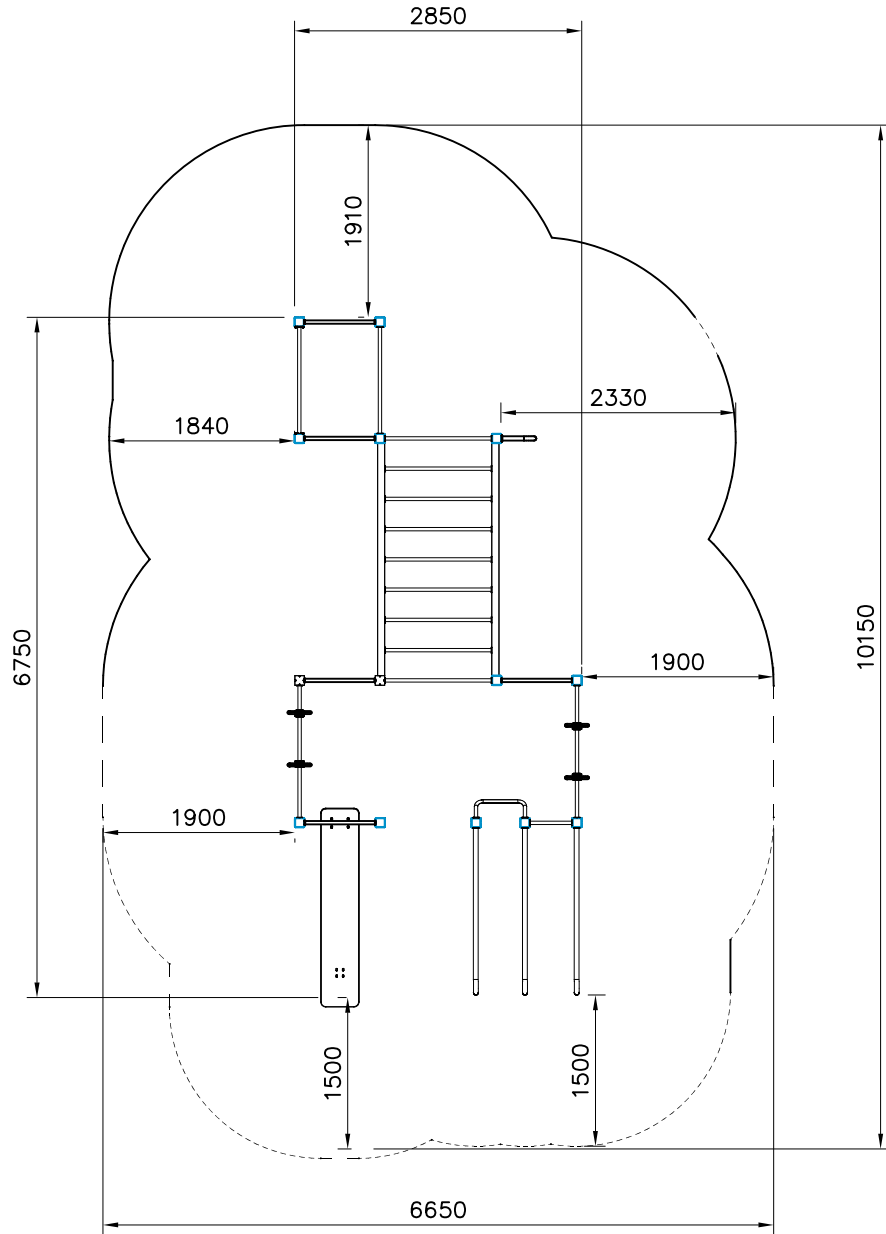
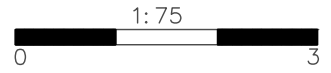

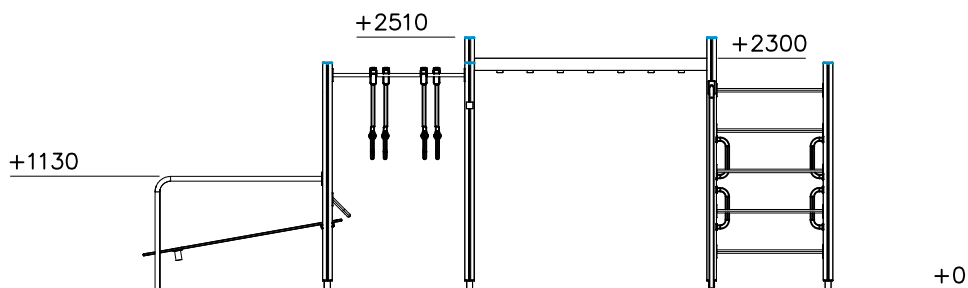
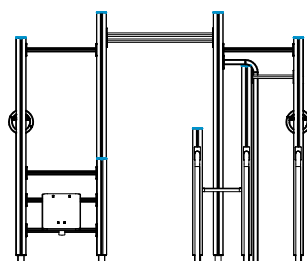

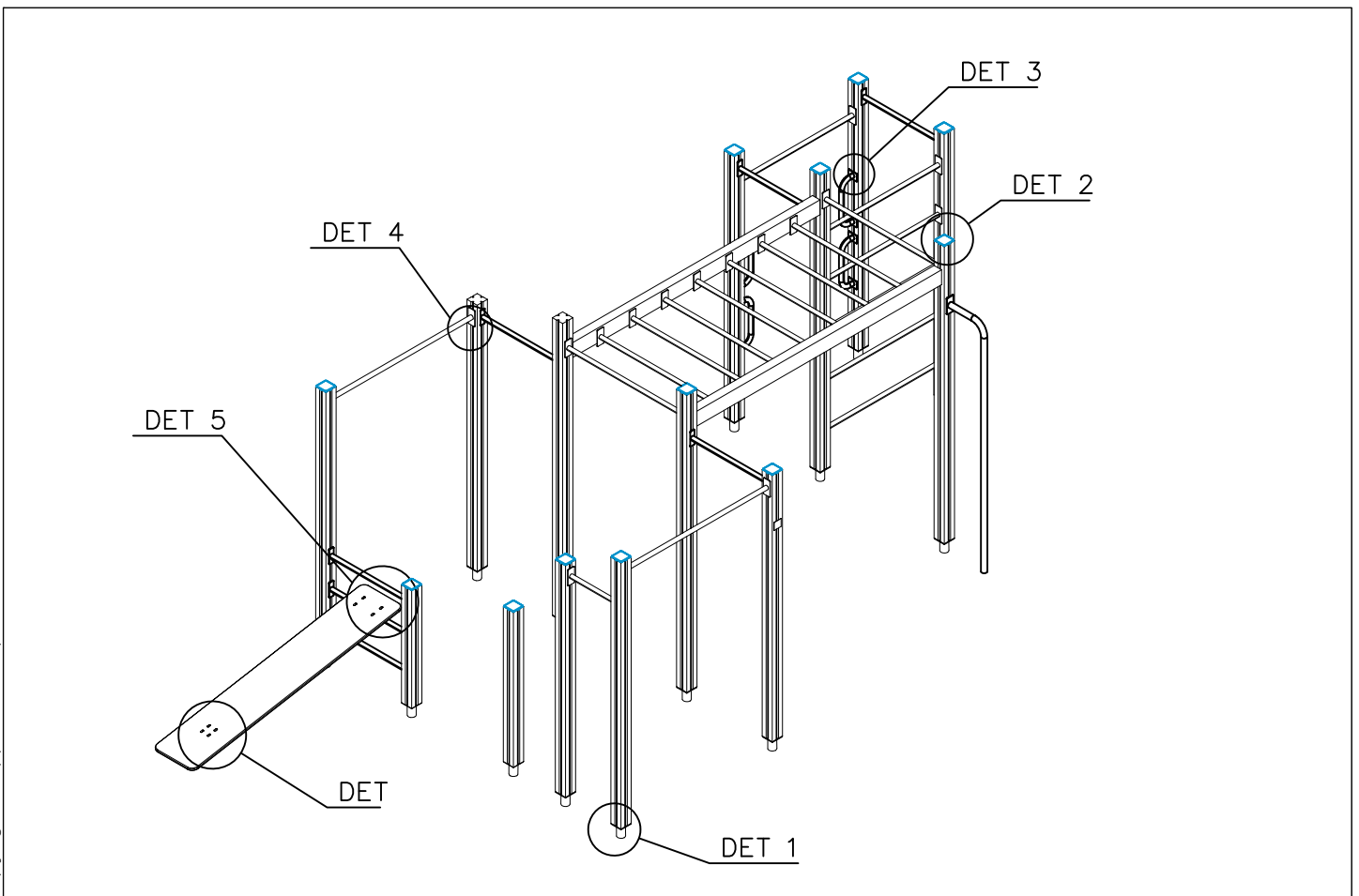
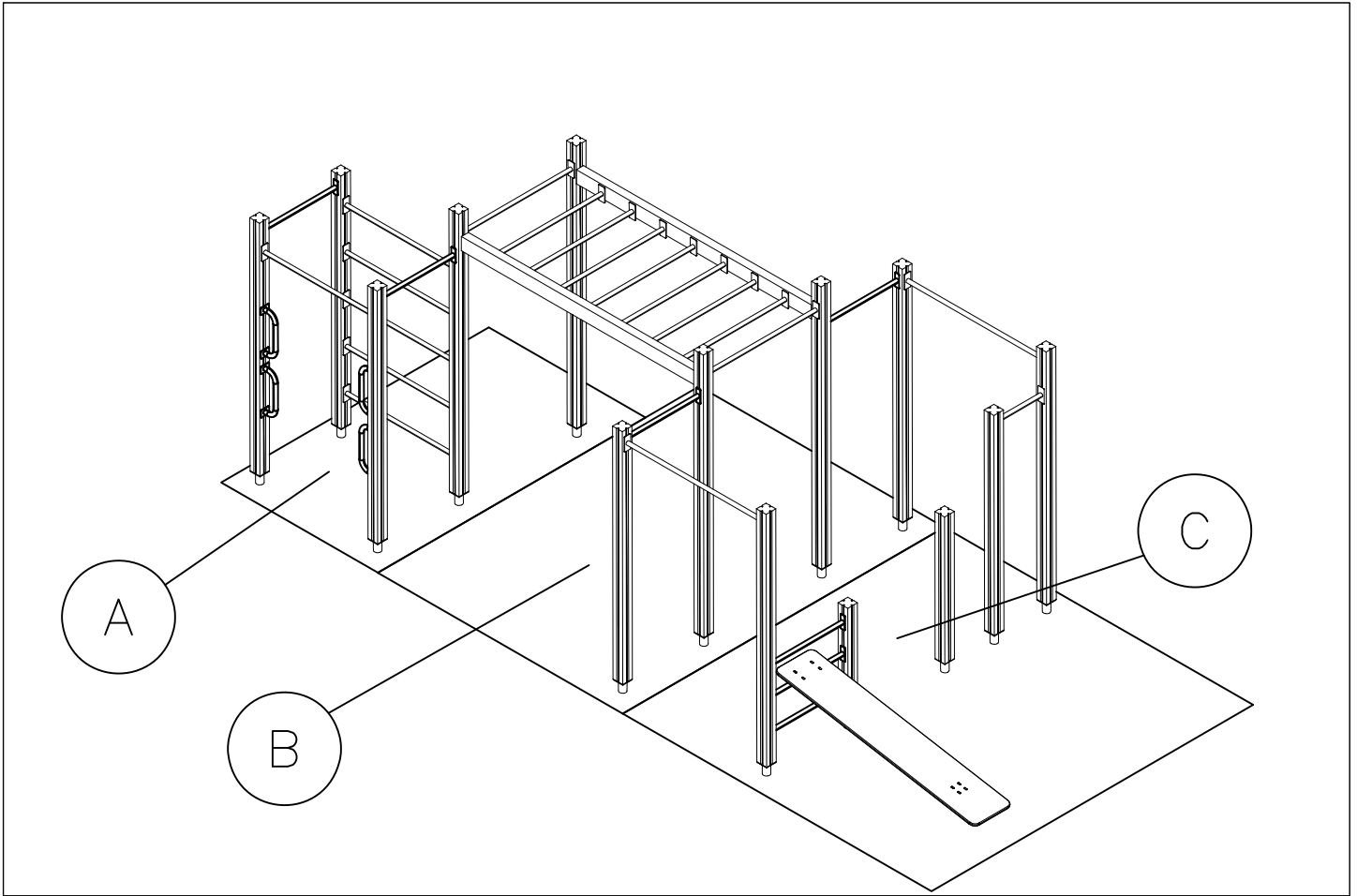

<p>DET 1</p>	<p>DET 2</p>	<p>DET 3</p>	<p>DET 4</p>
<p>DET 5</p>	<p>DET 6</p>		

DATE: 18.2.2021

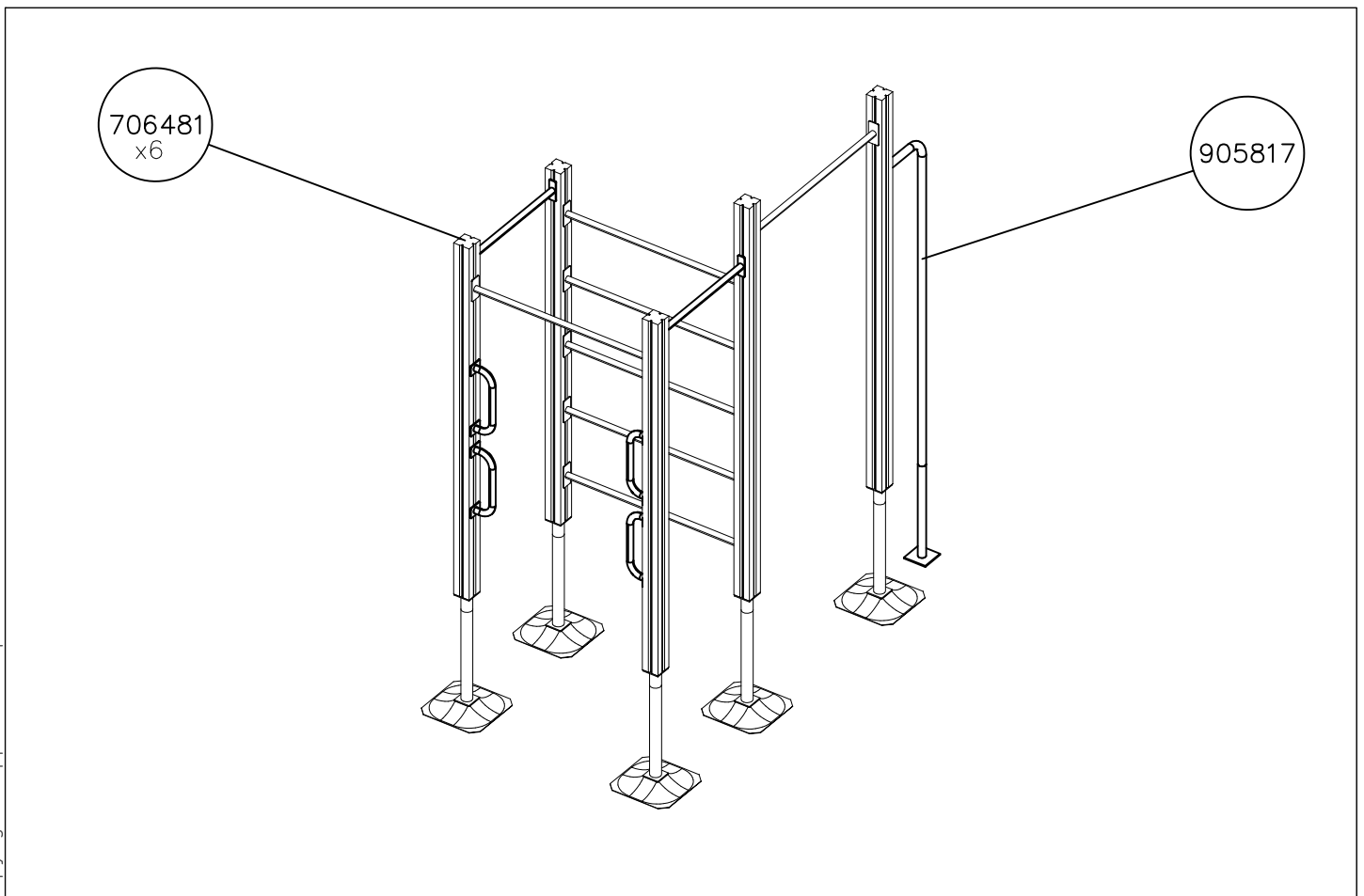
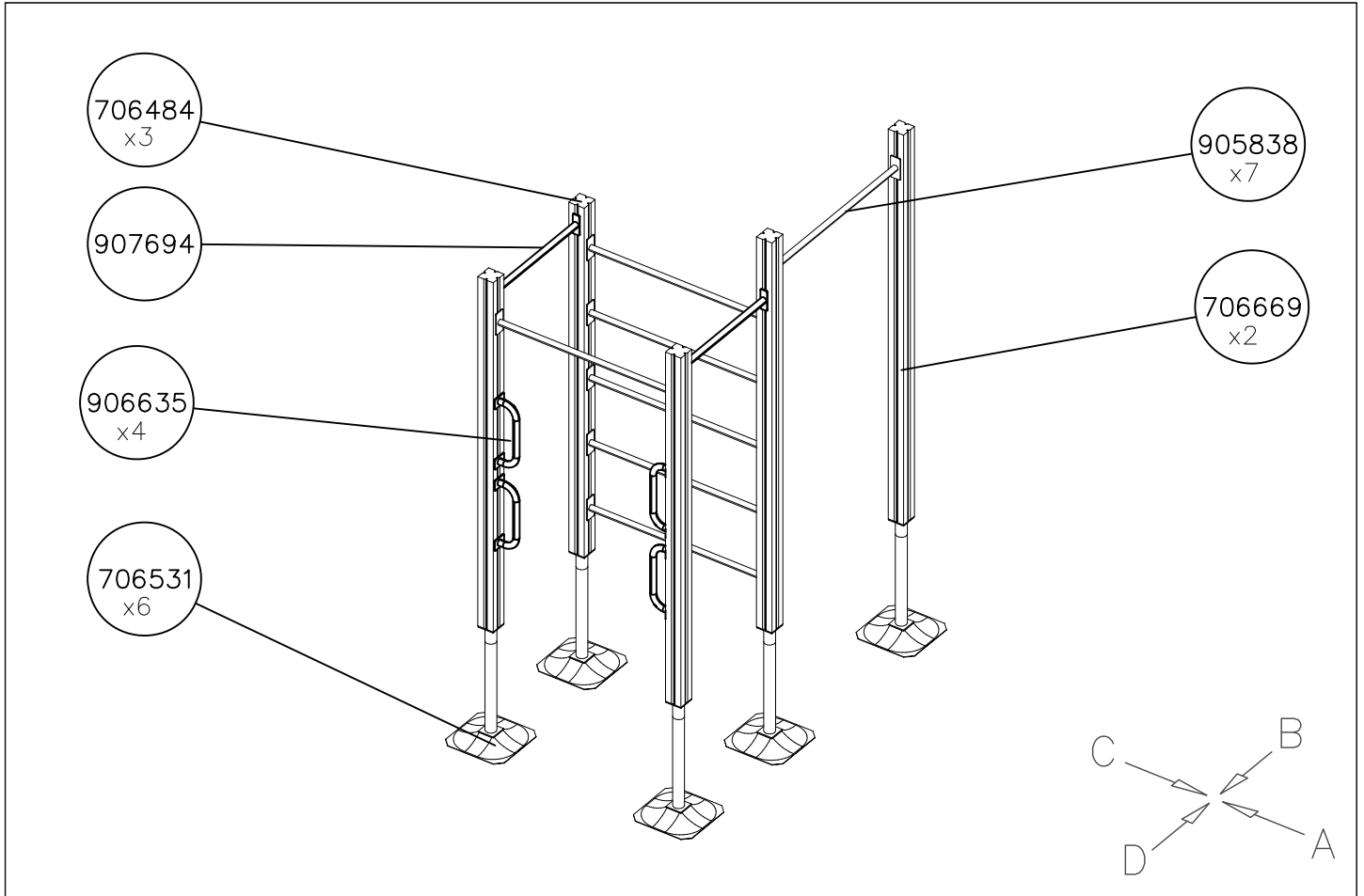

DATE: 18.2.2021

1:50

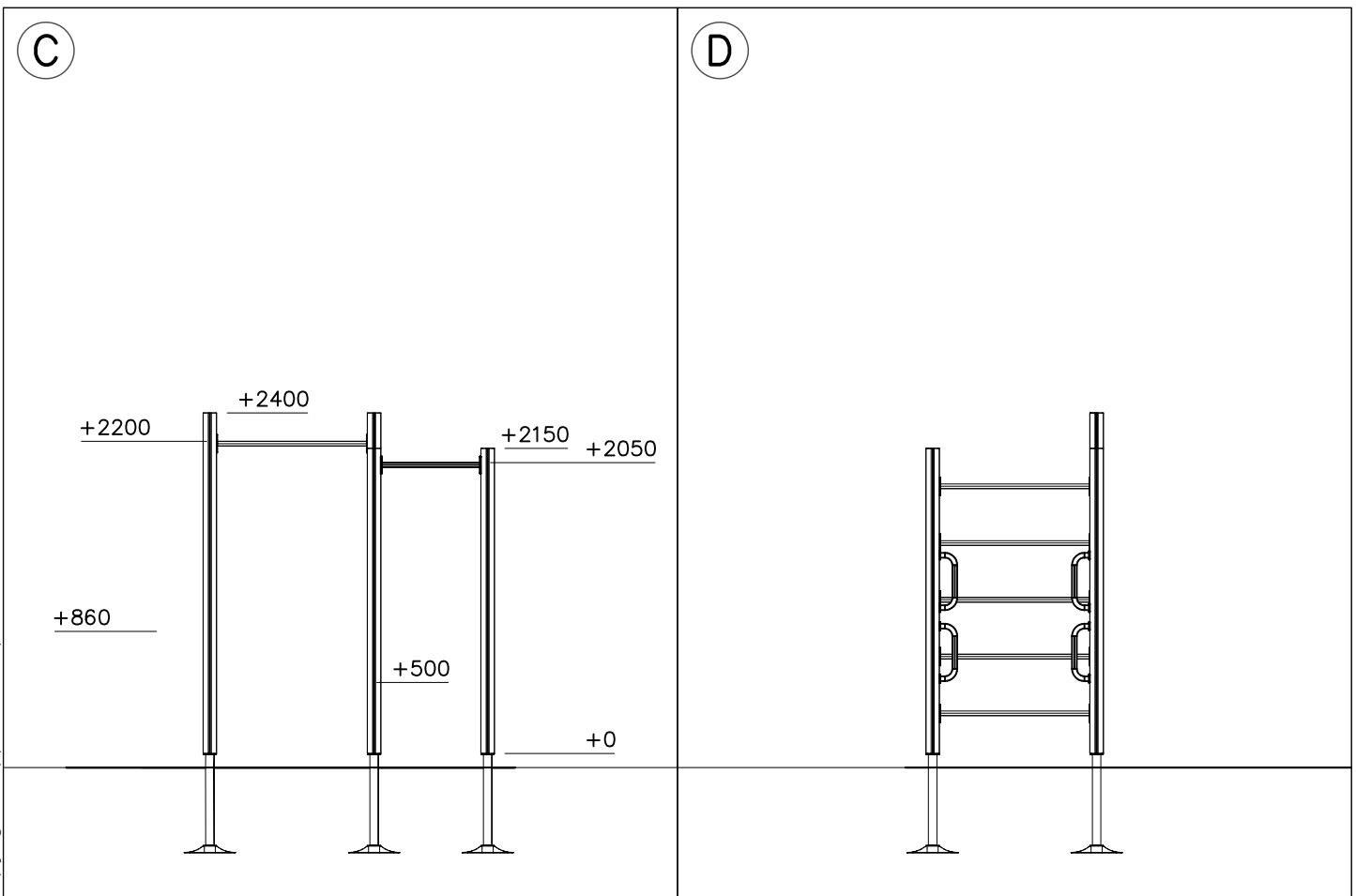
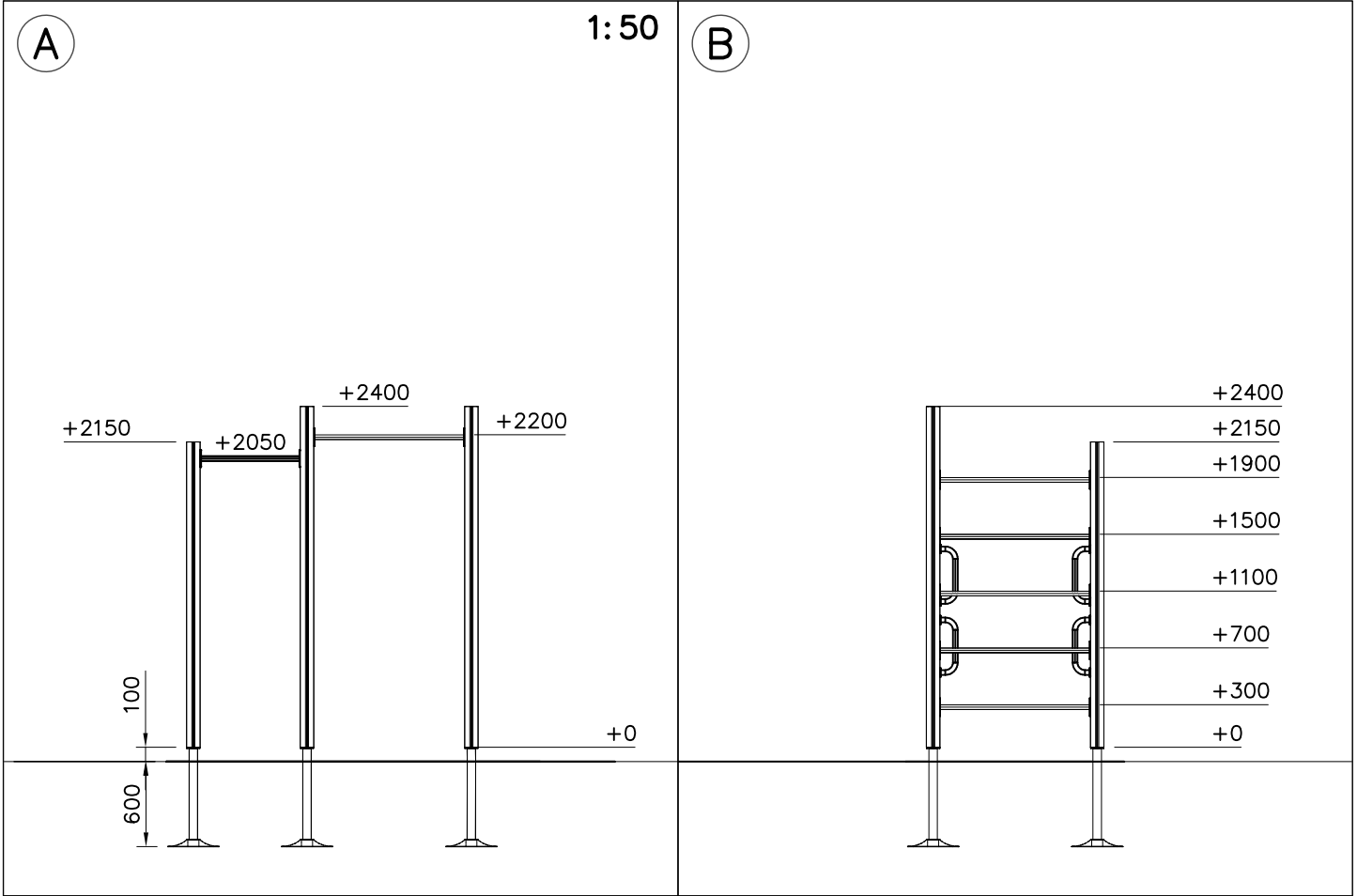

DATE: 18.2.2021

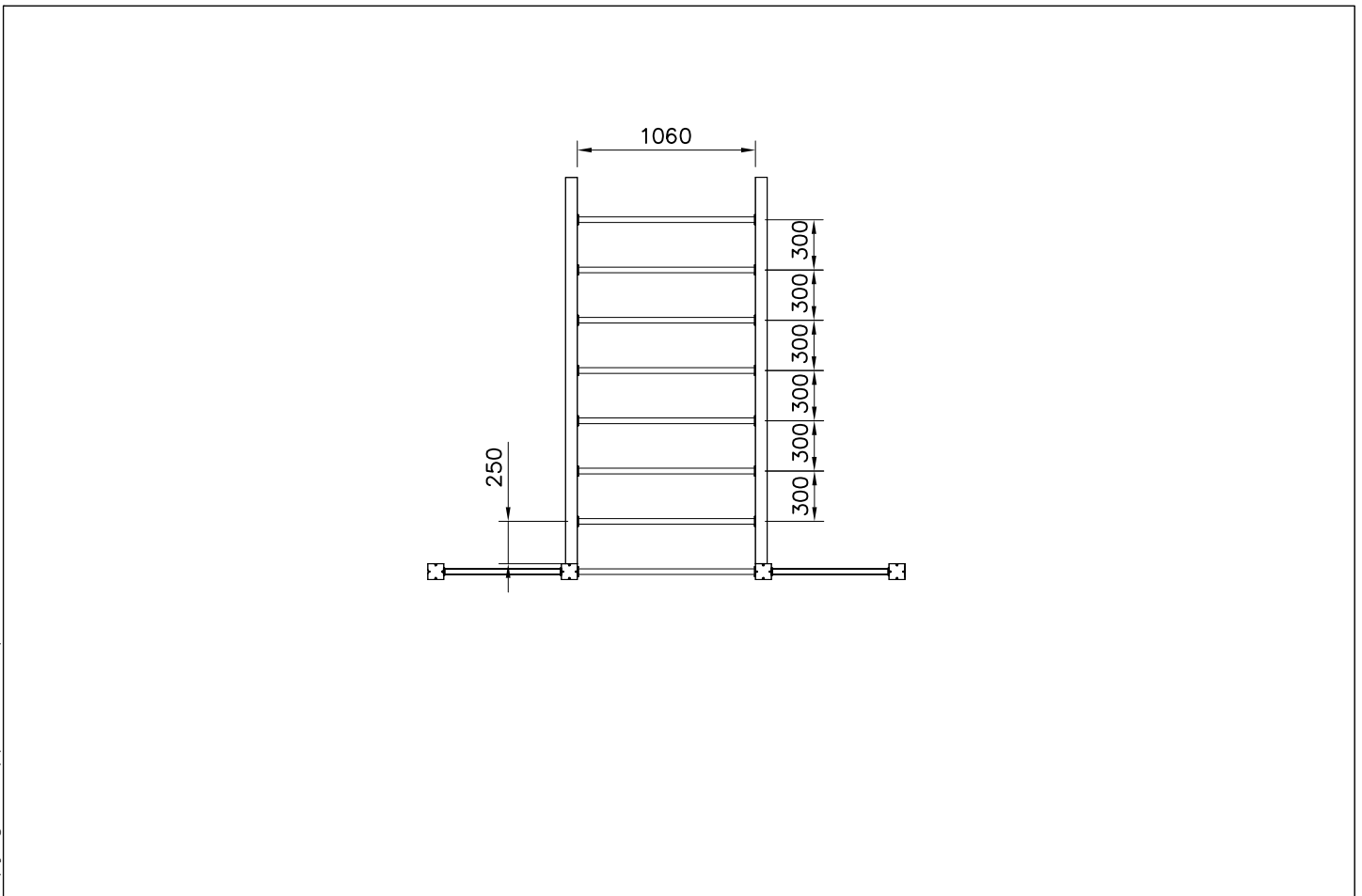
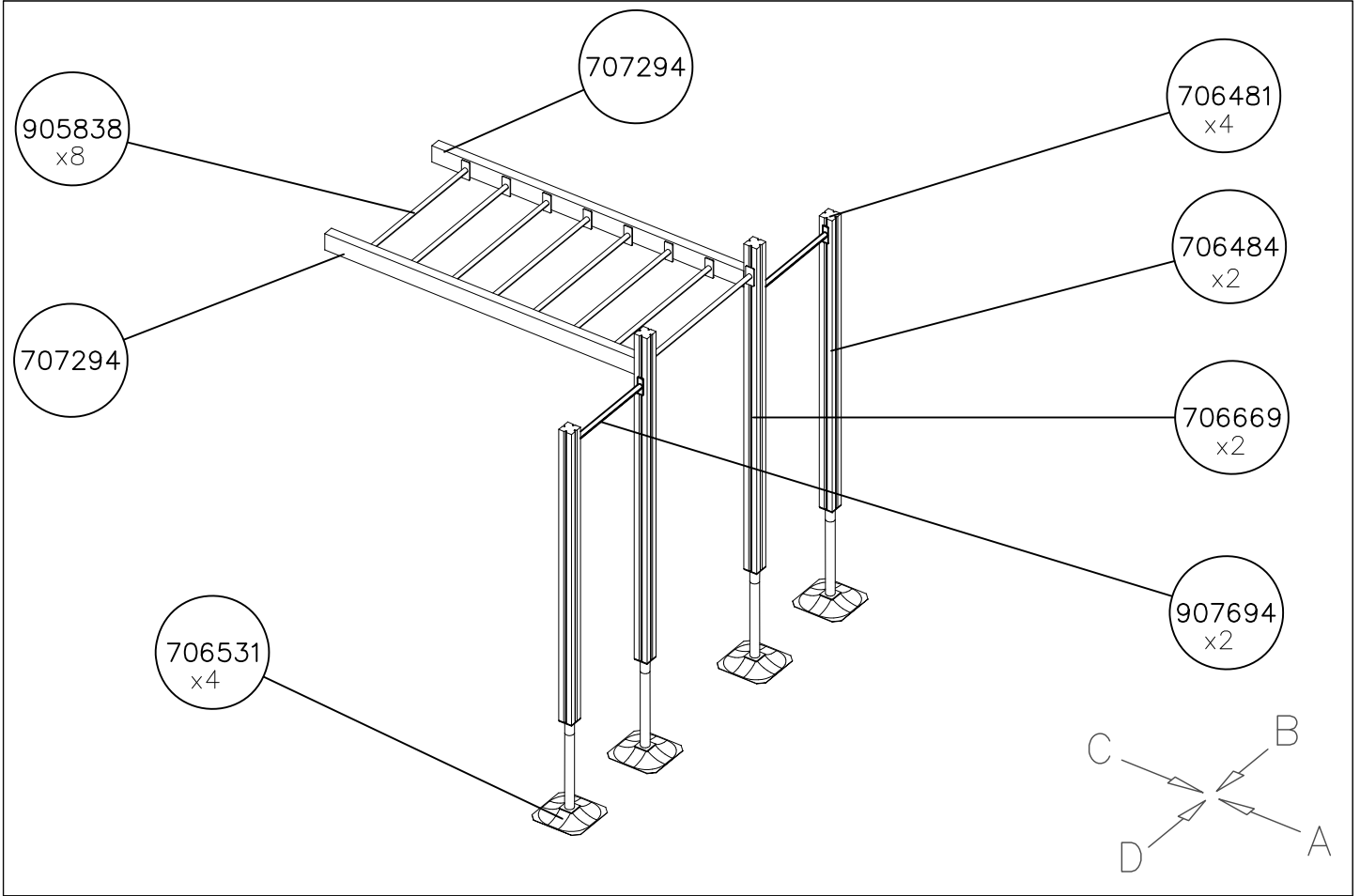

DATE: 18.2.2021

1:50

(A)

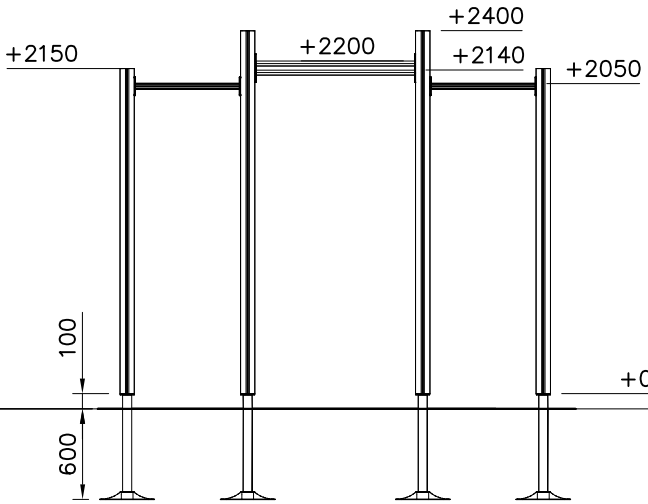

(B)

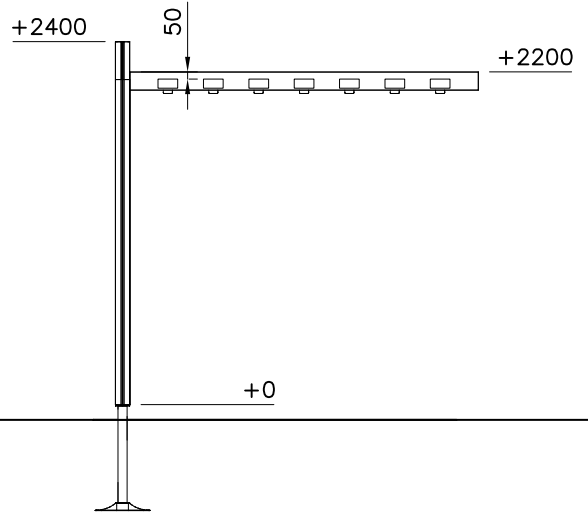

(C)

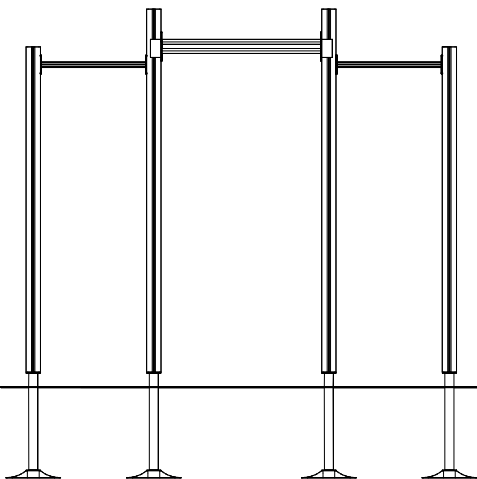

(D)

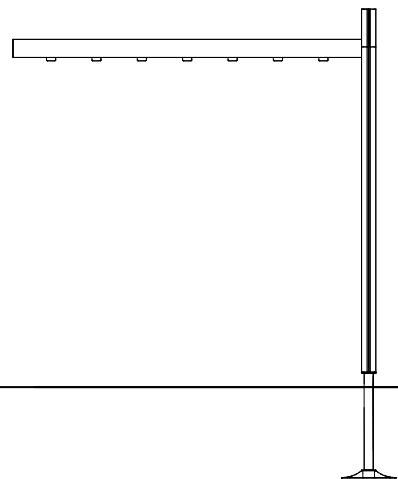

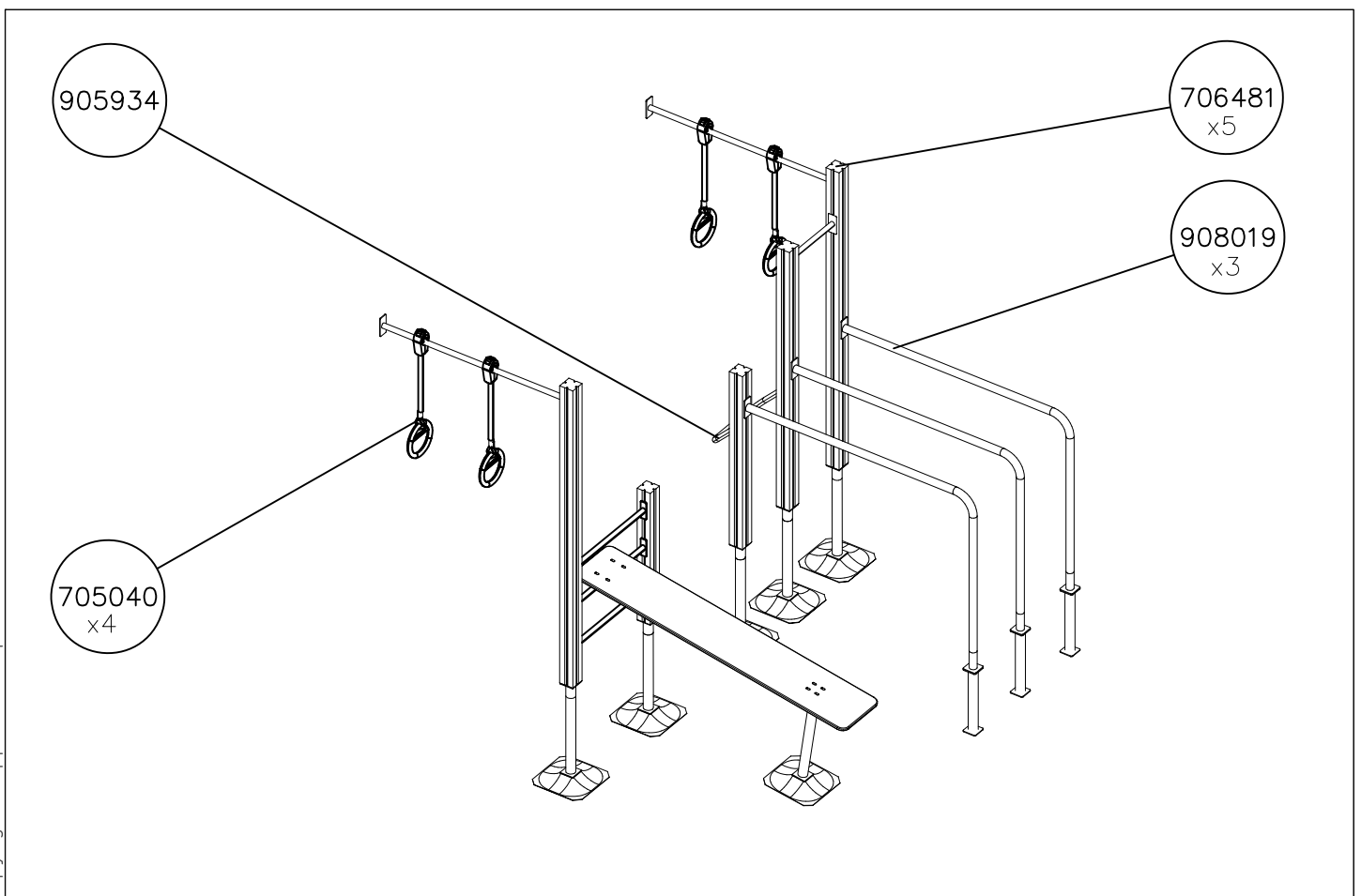
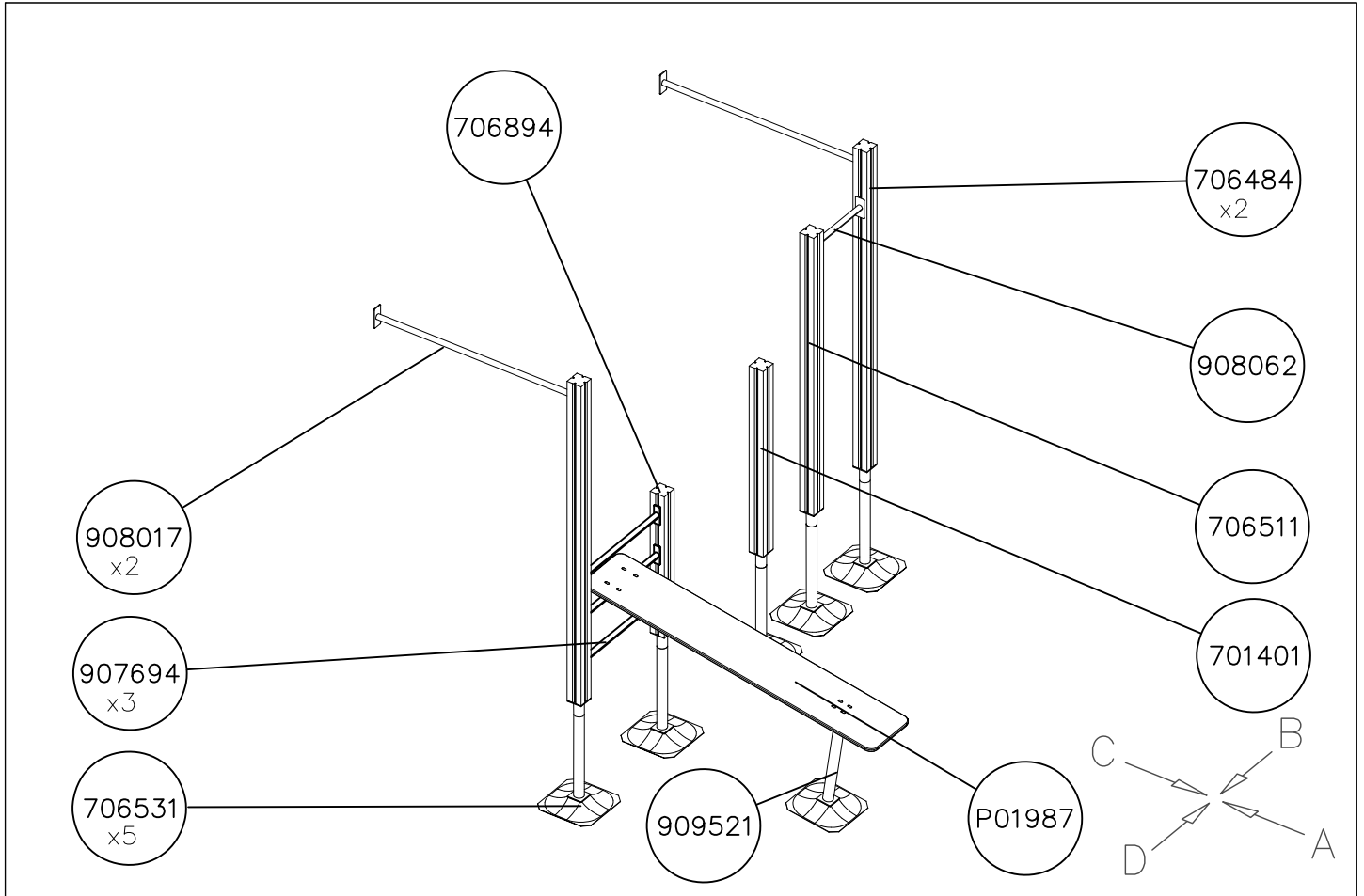





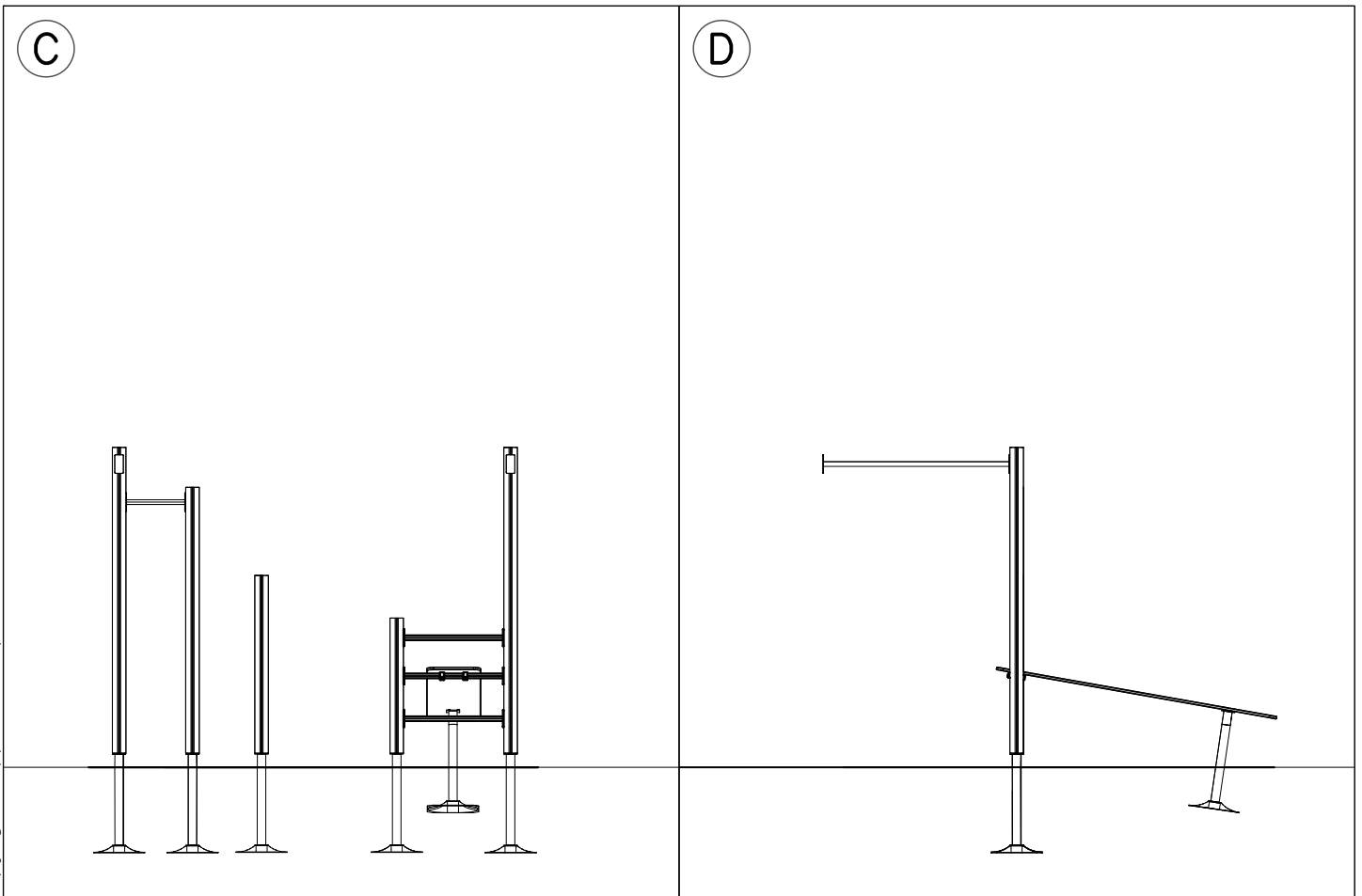
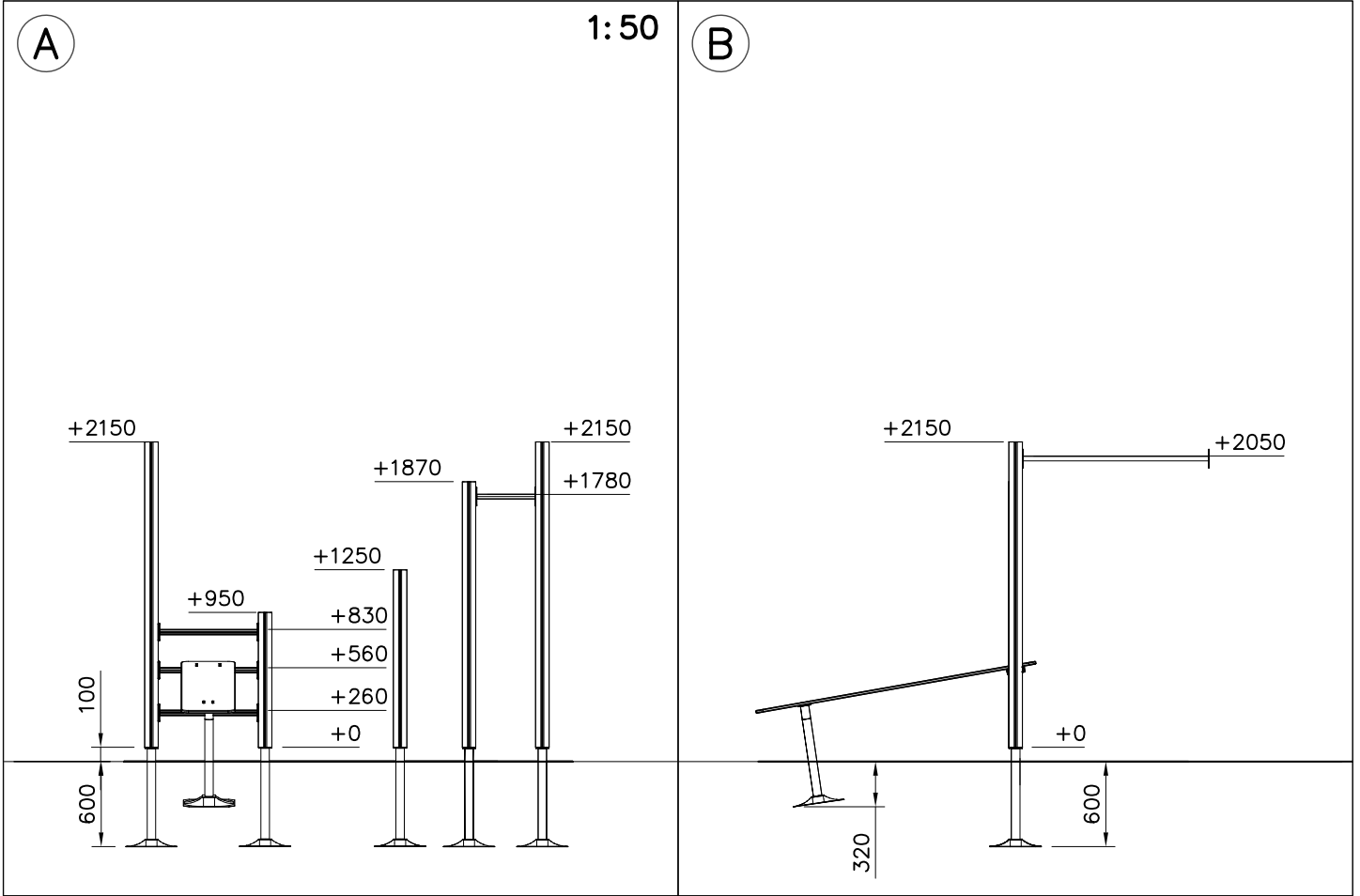

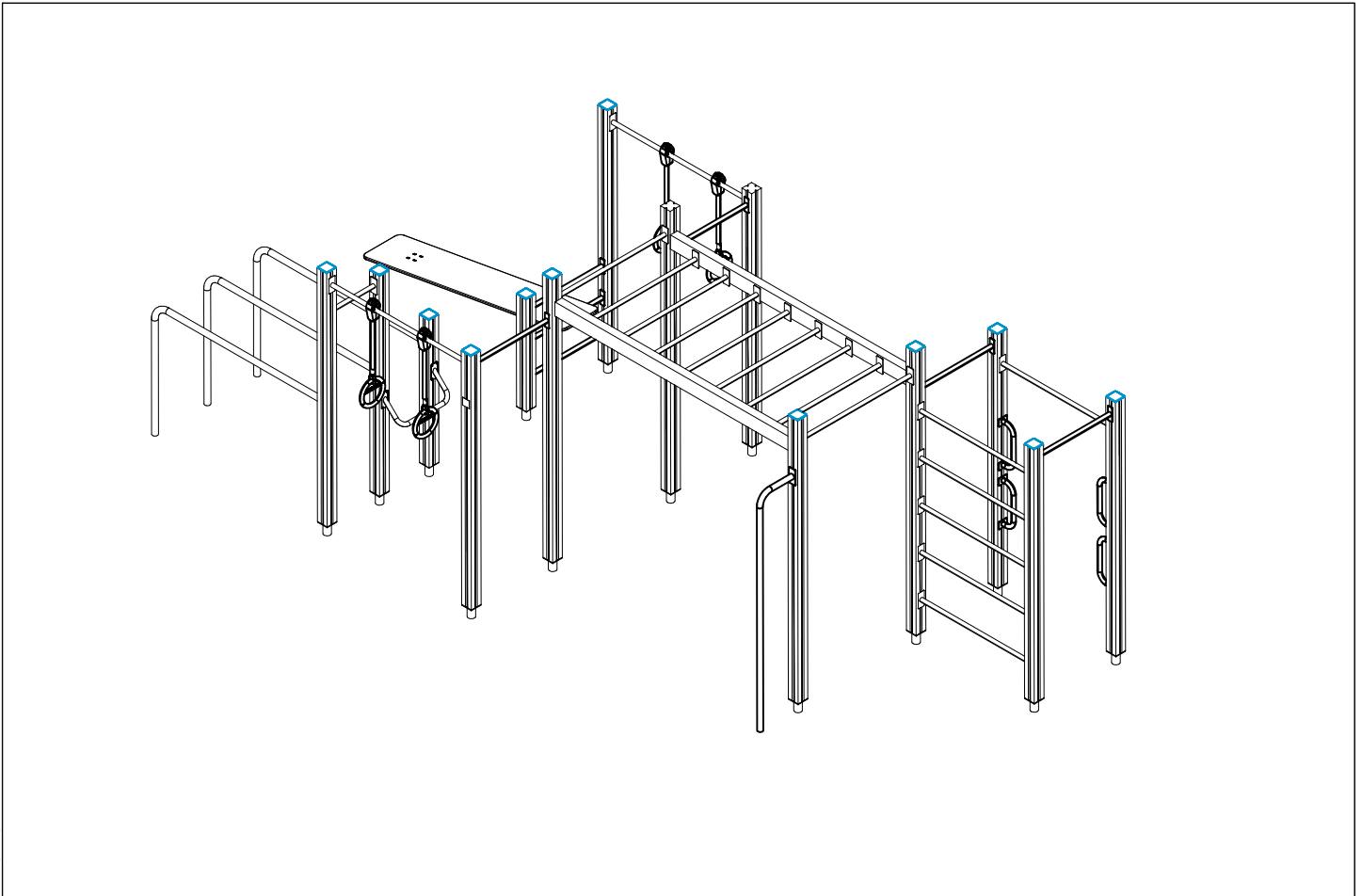
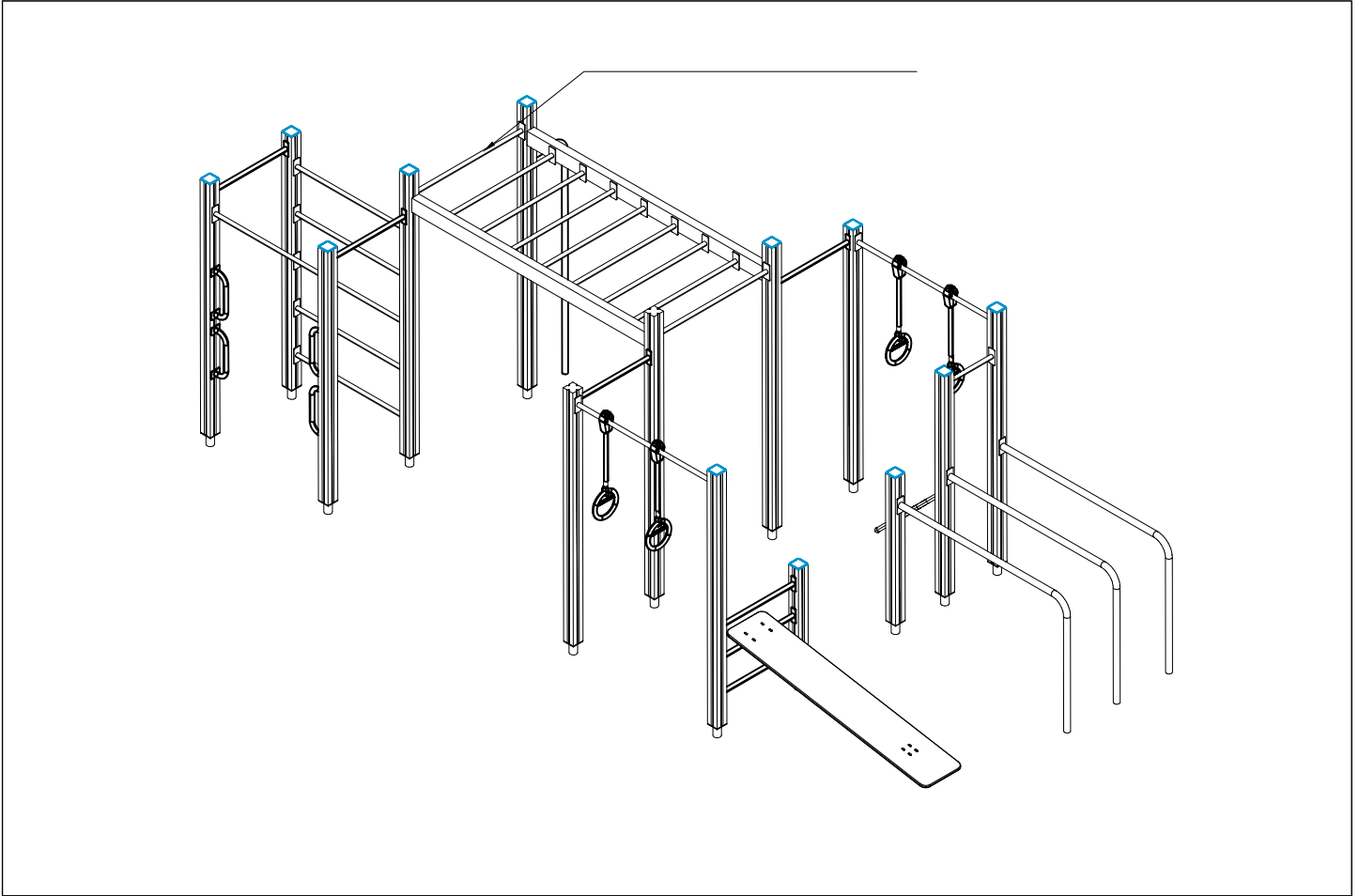
DATE: 18.2.2021

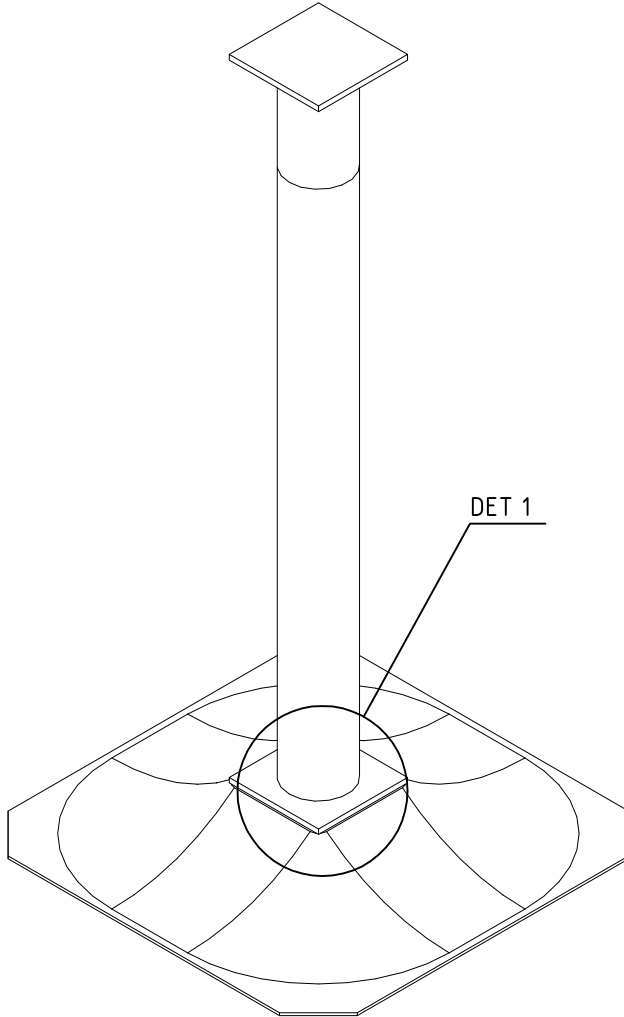
1:50



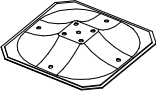



①	909511	PCS	②	909519	PCS
		1			1
③	909637	PCS	④	909638	PCS
		4			8
	M10			Ø20/10.5	
⑤	909639	PCS			PCS
		4			
	M10x25				
		PCS			PCS
		PCS			PCS
		PCS			PCS
		PCS			PCS
		PCS			PCS

DET 1

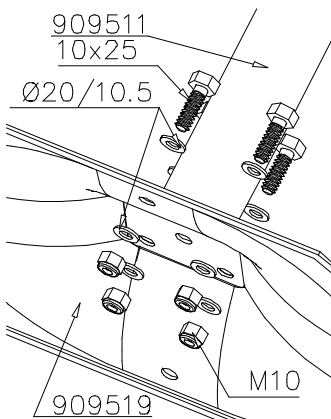



LAPPSET®
BETON FOUNDATION

FOOT

DATE: 27.10.2015

1(1)

② 905104	PCS		PCS
	4		
 M10	PCS		PCS



905104





Tuotekyltti tulee tuotteen mukana yhdellä seuraavista tavoista:

1) Metallinen tuotekyltti ja kiinnitysruuvit

- Kiinnitä tuotekyltti ruuveilla tolppaan noin 2 metrin korkeuteen kuvan 1 mukaisesti.

2) Tuotekylttitarra

- Puhdista maalattu metalli- tai vaneripinta pölystä ja kosteudesta. Liimaa tarra kuvan 2 mukaisesti.
- Huom. Älä kiinnitä tarraa karheapintaiseen laminaattiin tai maalattuun puuhun.

Vår produktmärkning levereras på ett av följande sätt:

1) Produktskylt i metall

- Fäst skylten med de medföljande skruvarna

2) Självhäftande produktetikett

- Rengör den pulverlackerade metallytan eller laminatyten så att den blir fri från smuts och fukt. Fäst etiketten enligt fig. 2.
- Obs! Fäst ej etiketten på detaljer med skrovlig yta eller på målat trä.

Product label is delivered by one of following ways:

1) Metal product label and screws

- Fasten the label with screws.

2) Label sticker

- Clean the painted metal or plywood surface from dirt and moisture. Fasten the sticker as shown in the figure 2.
- Note. Do not attach the sticker to rough surfaced laminate or painted wood.

La plaque d'informations produit est livrée sous l'une de ces 3 formes :

1) Plaque métallique et vis

- Fixez la plaque à l'aide des vis.

2) Etiquette autocollante

- Avant de coller l'étiquette, nettoyez le composant métallique peint ou la plaque de contreplaqué, de toute saleté. La surface doit être sèche (voir image 2).
- Attention, ne pas coller l'étiquette sur une surface lamellé-collée irrégulière ou sur du bois peint.

Die Auslieferung des Produktaufklebers erfolgt auf eine dieser Arten:

1) Produkt-Schild aus Metall incl. Schrauben

- Die Befestigung des Schildes erfolgt mittels der Schrauben.

2) Aufkleber

- Entfernen Sie zunächst Schmutz und Feuchtigkeit vom lackierten Metall bzw. von der Holzoberfläche und bringen Sie den Aufkleber wie im Bild oben rechts beschrieben auf den gesäuberten Untergrund auf.
- Beachten Sie: Bringen Sie den Aufkleber nicht auf raues laminiertes oder lackiertes Holz an.

LAPPSET® DEEP FOUNDATION

FOOT

DATE: 15.5.2018

1(1)



①	909511	PCS	②	909519	PCS
		1		1	
	90x90x650		50x380x380		

③	909637	PCS	④	909638	PCS
		4		8	
	M10		Ø20/10.5		

⑤	909639	PCS	⑥	905104	PCS
		4		4	
	M10x25		M10		

OPTION FOOT

①	911155	PCS			PCS
		1			
	90x90x650				