

# LAPPSET®

## FINNO



ASENNUSOHJE  
MONTERINGSANSVISNING  
INSTALLATION INSTRUCTION  
AUFBAUANLEITUNG  
NOTICE D'INSTALLATION

DATE: 11.3.2021

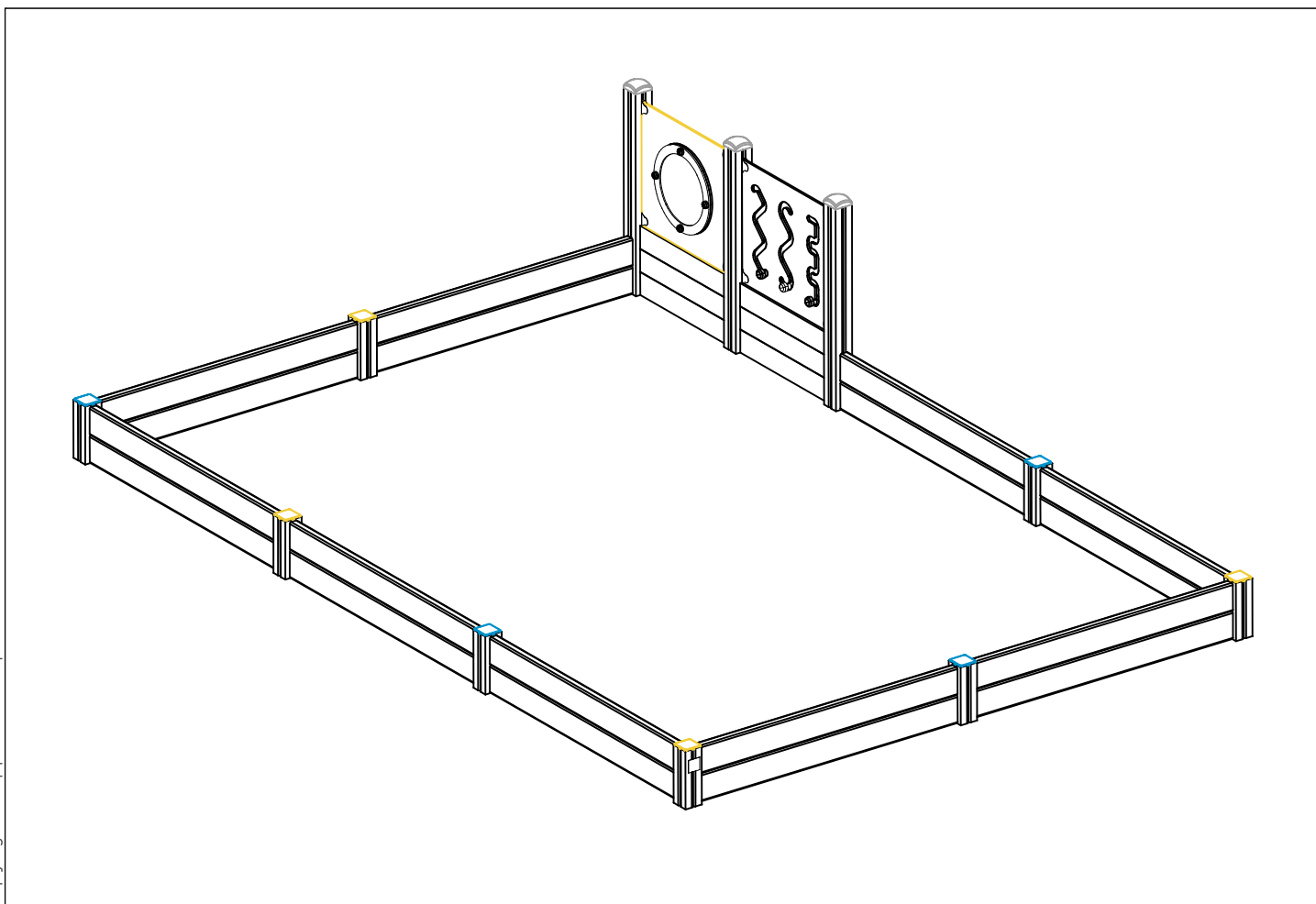
### Q15296-1

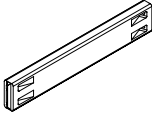
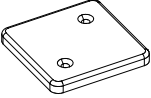
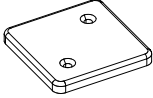

DATE: 11.3.2021

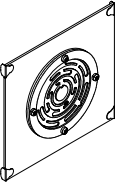
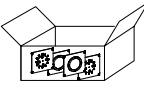
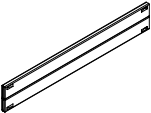
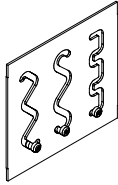
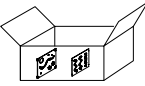
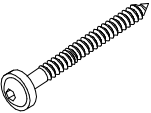
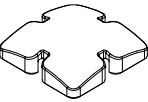
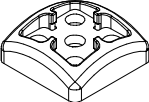
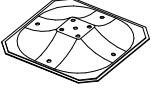
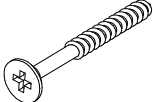
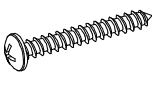
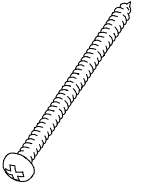
702286  65x65	PCS 1	706439-603  L 704	PCS 6	706481-701  83x83x10	PCS 4	706481-702  83x83x10	PCS 4	706527-603  93x93x1600	PCS 3	706577-603  93x93x600	PCS 8
706766-702 	PCS 1	706778 	PCS 1	706887-603  45x290x1524	PCS 9	707386-702  10x640x702	PCS 1	707450 	PCS 1	903093  Ø8x90	PCS 60
905138  GRAY	PCS 3	905196  GRAY	PCS 3	909519  50x380x380	PCS 3	980107  Ø6x60	PCS 16	980114  Ø4x20	PCS 4	980131  Ø6x60	PCS 12
	PCS		PCS		PCS		PCS		PCS		PCS
	PCS		PCS		PCS		PCS		PCS		PCS
	PCS		PCS		PCS		PCS		PCS		PCS
	PCS		PCS		PCS		PCS		PCS		PCS

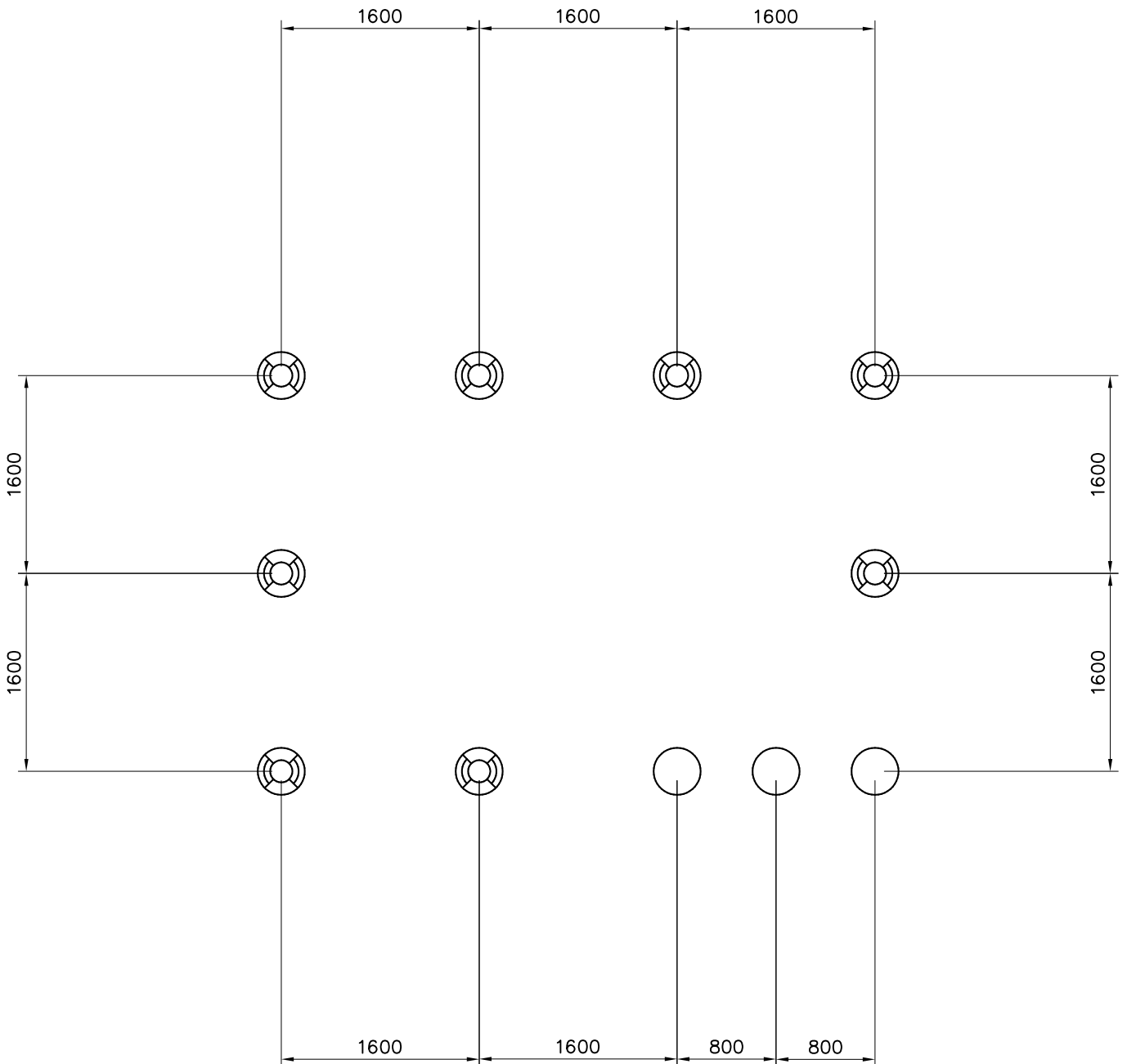
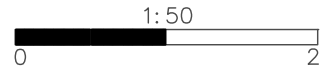

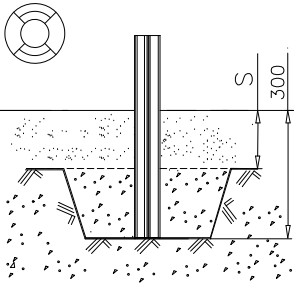
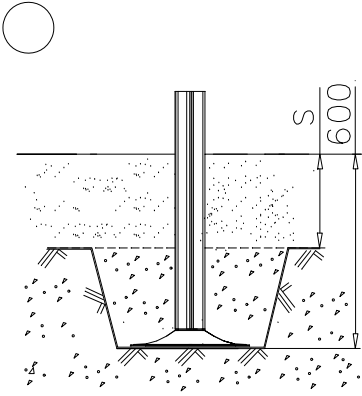
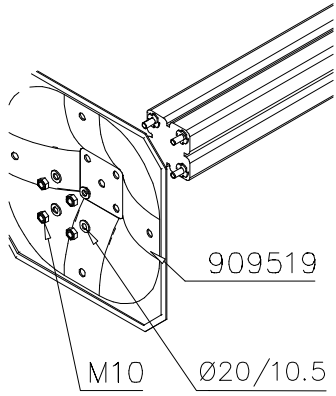
 <p>Technical drawing showing a vertical post embedded in a concrete base. The height of the post above the base is dimensioned as 300. A small circular detail is shown in the top left corner.</p>	 <p>Technical drawing showing a vertical post embedded in a concrete base. The height of the post above the base is dimensioned as 600. A small circular detail is shown in the top left corner.</p>	 <p>Technical drawing showing a detail of a post connection. The drawing includes a plate labeled 909519, a post labeled M10, and a hole labeled Ø20/10.5.</p>

----- Falling Space 47.7 m<sup>2</sup>  
Max falling height 290 mm

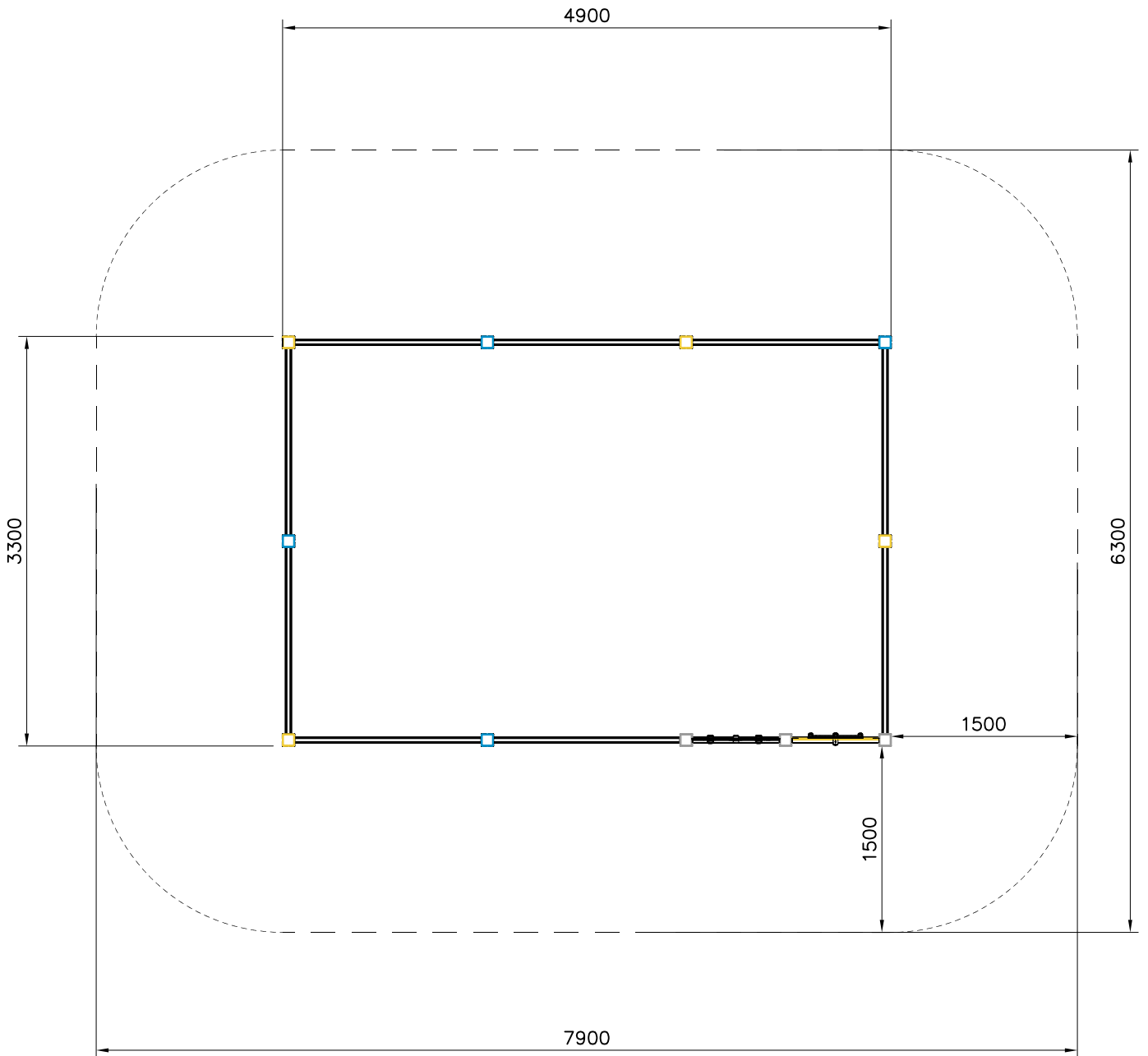

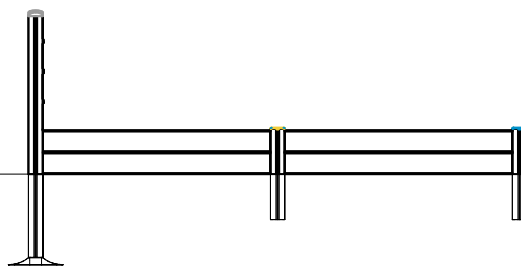
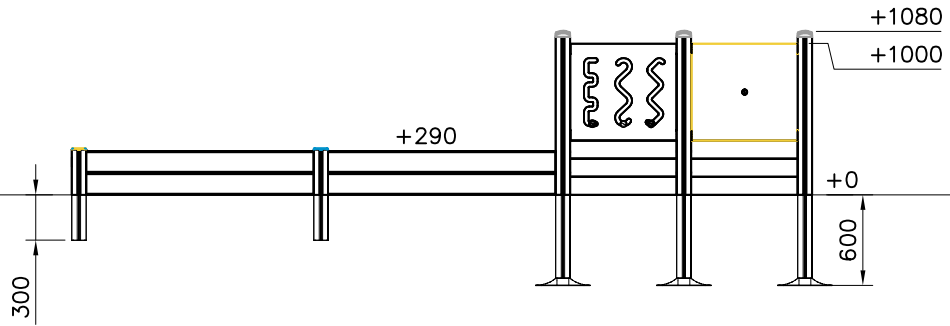

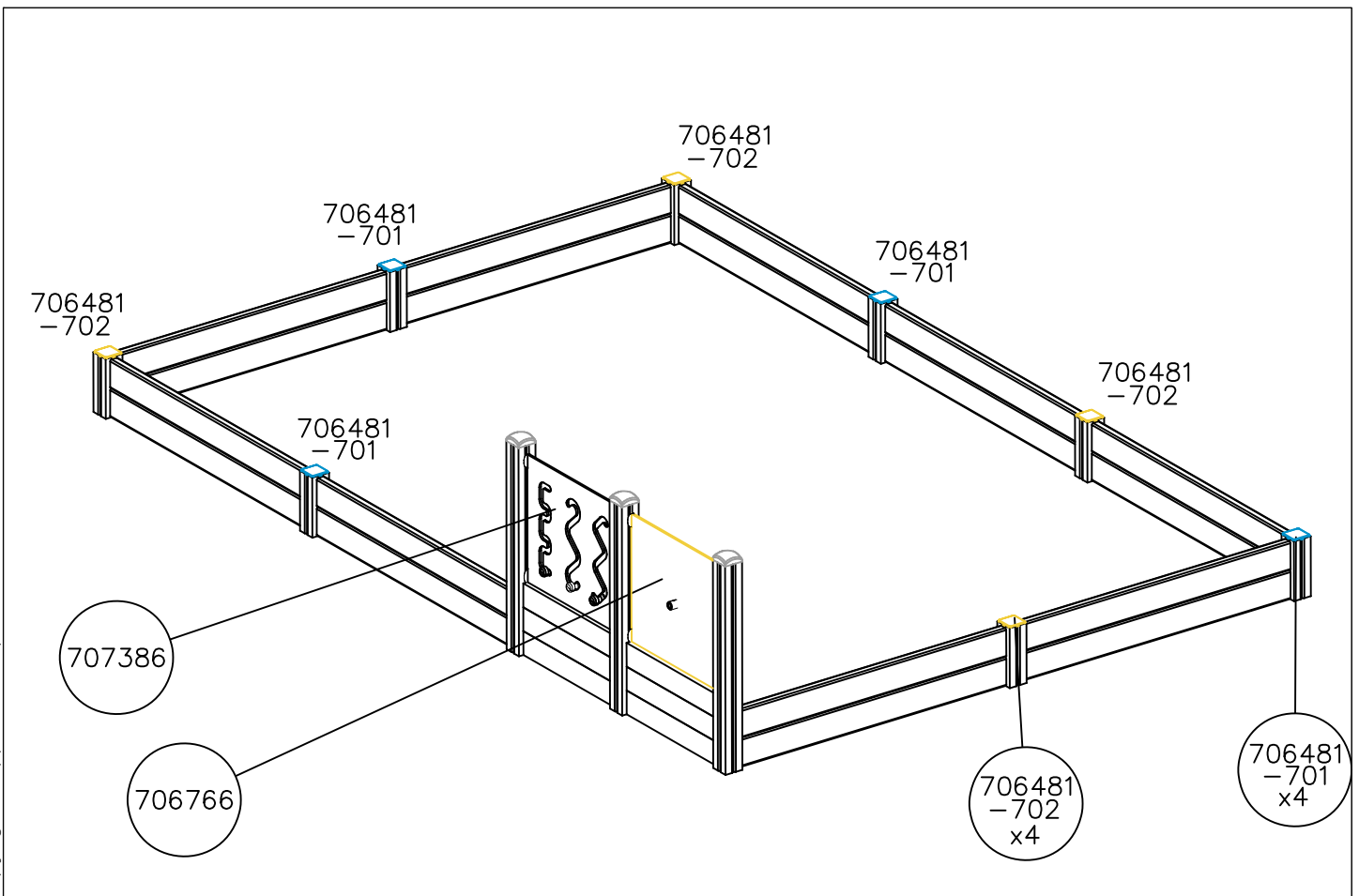
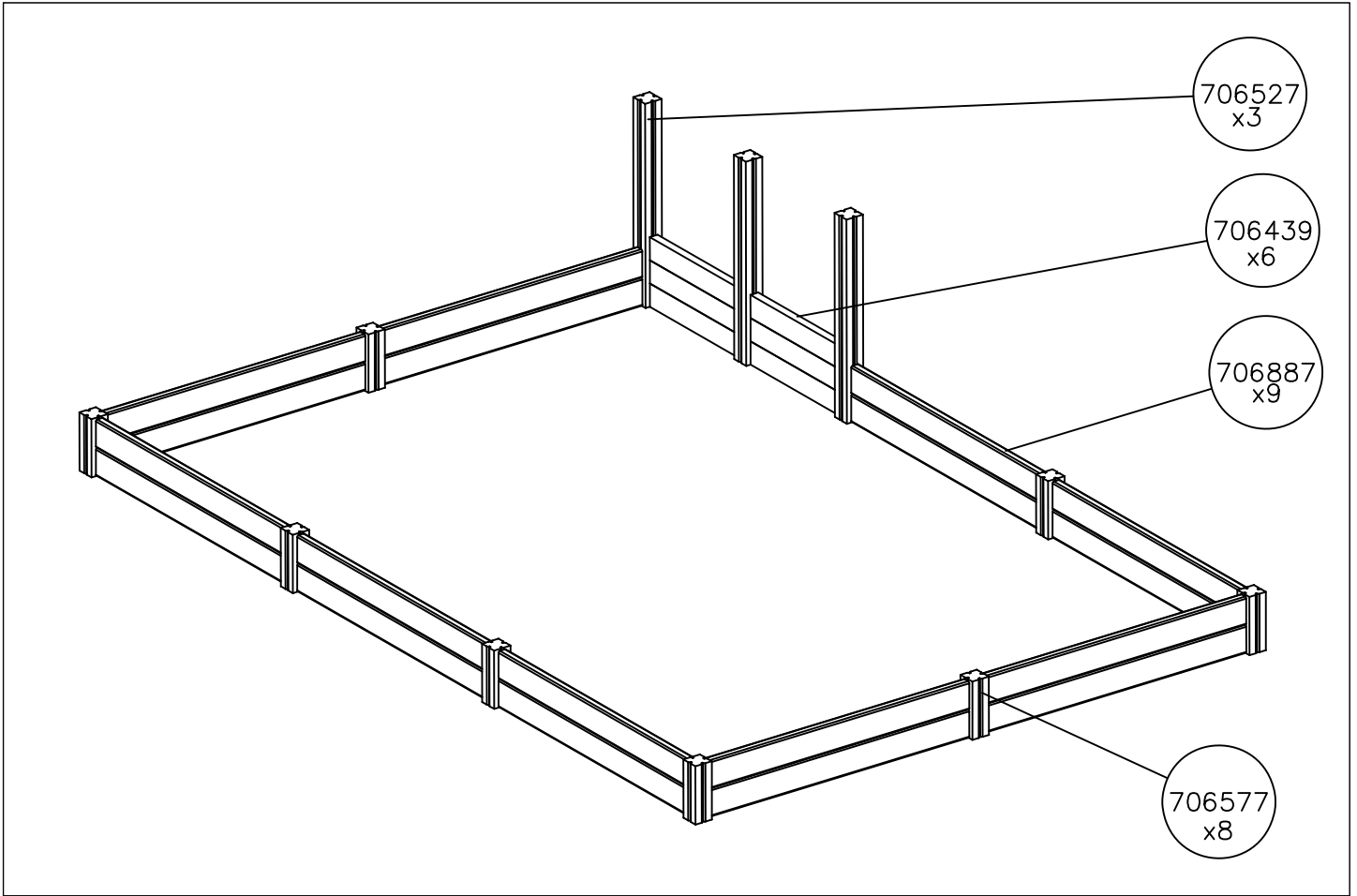

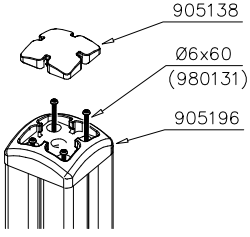
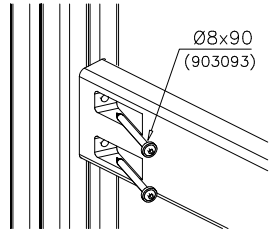
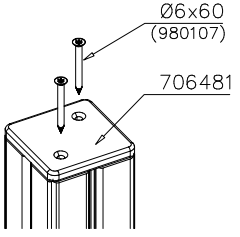
<p>DET 1</p> 	<p>DET 2</p> 	<p>DET 3</p> 	



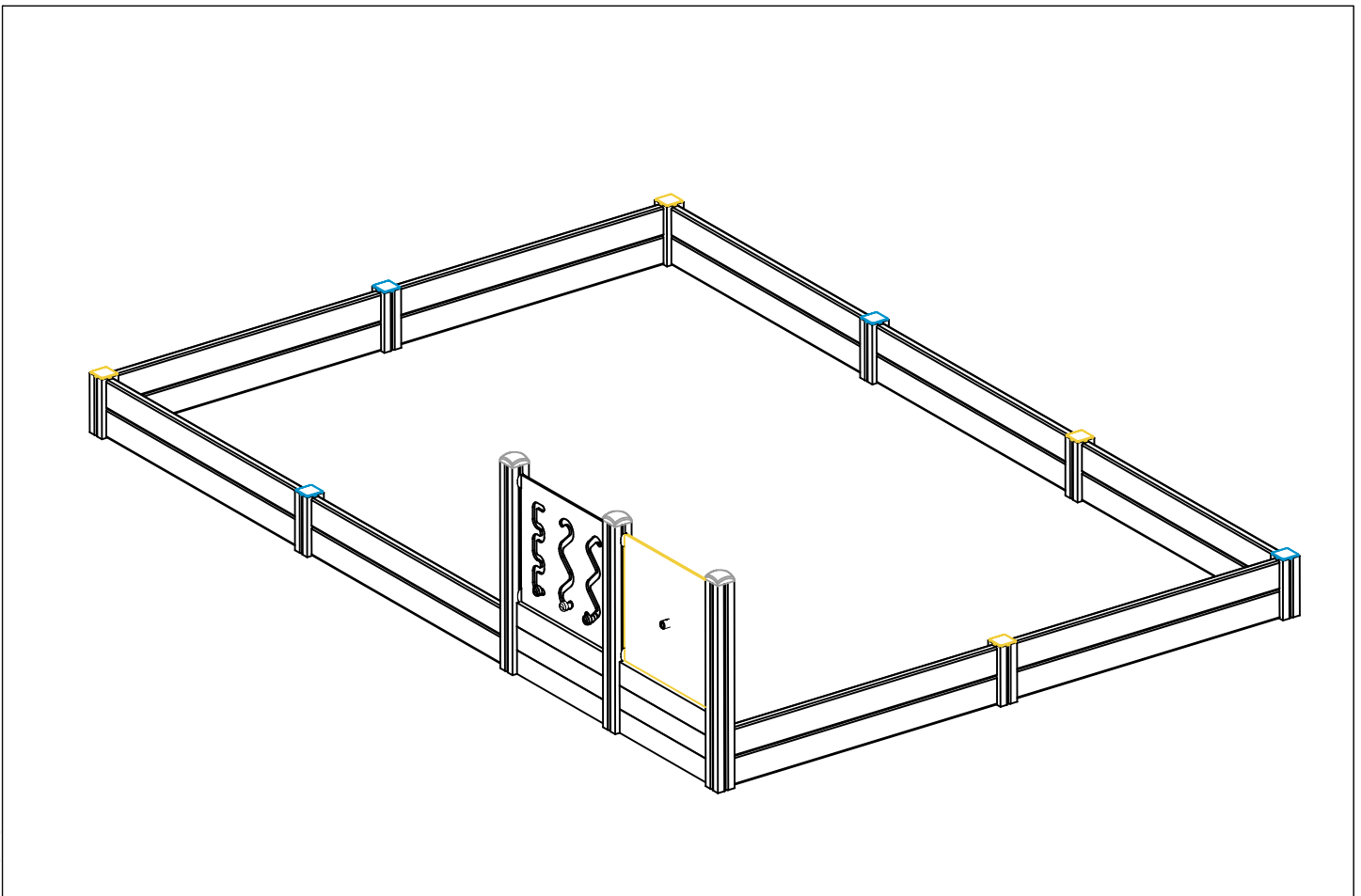
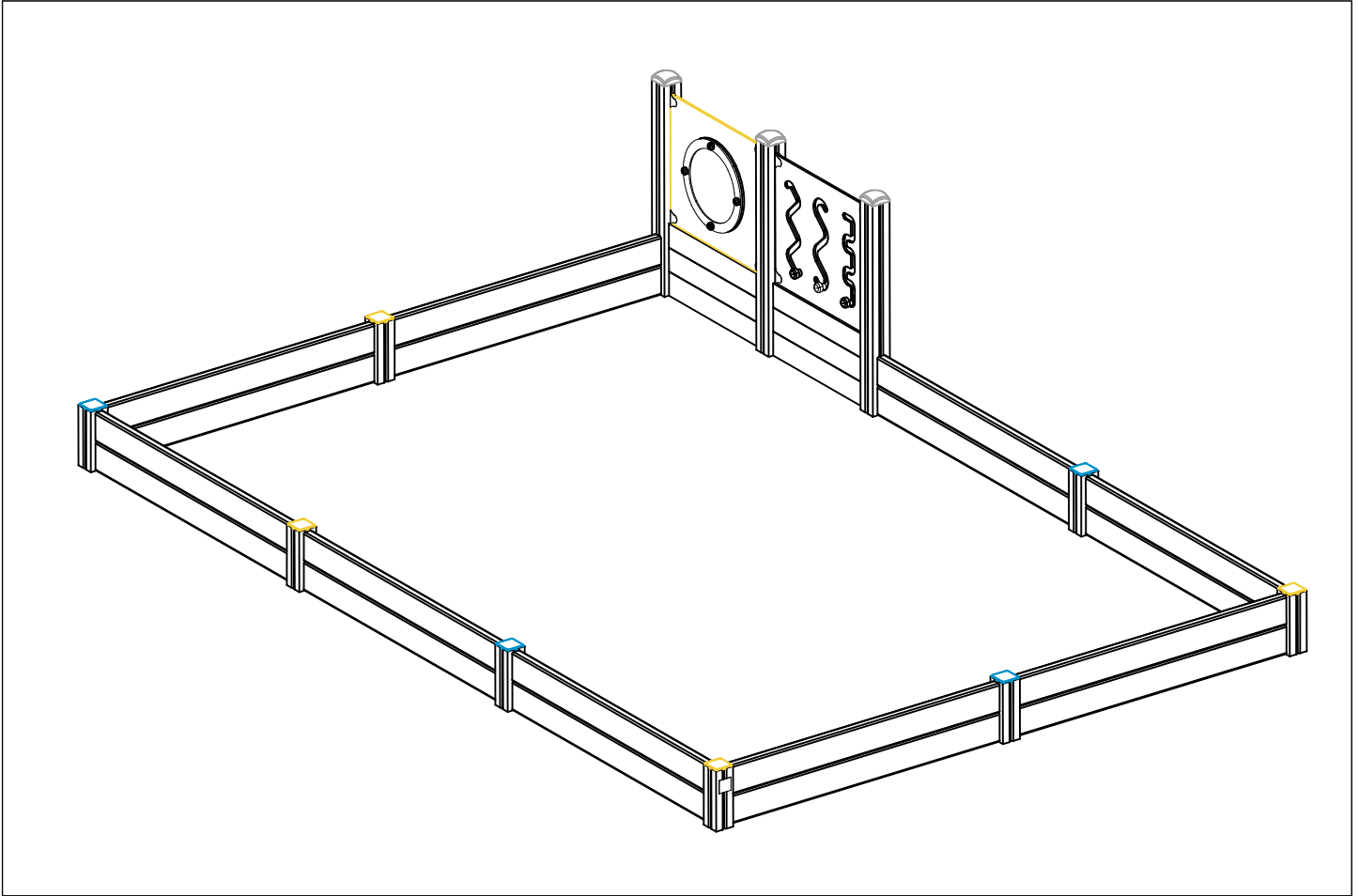

① 903176	PCS	② 909850	PCS
	4		4
		M8x25	
③ 909256	PCS	④ 909633	PCS
	8		4
Ø16/8.4x1.6		M8	
⑤ 980123	PCS		PCS
	4		
Ø7x60			

**\*Note:**  
No gaps between:  
8–25mm  
89–230mm

COLOR OPTIONS	
-701	BLUE
-702	YELLOW
-703	LIME
-704	DARK GRAY
-705	LIGHT GRAY
-706	RED
-707	GREEN
-708	FUXIA

GAME WALL OPTIONS

706766	706772	706308	707453
			
640x702	640x702	640x702	640x702
707209	705705	707433	707386
			
640x702	640x702	640x702	640x702
709403	709358	709405	
			
640x702	640x702	420x702	

DET 1



DET 2





**Tuotekyltti tulee tuotteen mukana yhdellä seuraavista tavoista:**

**1) Metallinen tuotekyltti ja kiinnitysruuvit**

- Kiinnitä tuotekyltti ruuveilla tolppaan noin 2 metrin korkeuteen kuvan 1 mukaisesti.

**2) Tuotekylttitarra**

- Puhdista maalattu metalli- tai vaneripinta pölystä ja kosteudesta. Liimaa tarra kuvan 2 mukaisesti.
- Huom. Älä kiinnitä tarraa karheapintaiseen laminaattiin tai maalattuun puuhun.

**Vår produktmärkning levereras på ett av följande sätt:**

**1) Produktskylt i metall**

- Fäst skylten med de medföljande skruvarna

**2) Självhäftande produktetikett**

- Rengör den pulverlackerade metallytan eller laminatyten så att den blir fri från smuts och fukt. Fäst etiketten enligt fig. 2.
- Obs! Fäst ej etiketten på detaljer med skrovlig yta eller på målat trä.

**Product label is delivered by one of following ways:**

**1) Metal product label and screws**

- Fasten the label with screws.

**2) Label sticker**

- Clean the painted metal or plywood surface from dirt and moisture. Fasten the sticker as shown in the figure 2.
- Note. Do not attach the sticker to rough surfaced laminate or painted wood.

**La plaque d'informations produit est livrée sous l'une de ces 3 formes :**

**1) Plaque métallique et vis**

- Fixez la plaque à l'aide des vis.

**2) Etiquette autocollante**

- Avant de coller l'étiquette, nettoyez le composant métallique peint ou la plaque de contreplaqué, de toute saleté. La surface doit être sèche (voir image 2).
- Attention, ne pas coller l'étiquette sur une surface lamellé-collée irrégulière ou sur du bois peint.

**Die Auslieferung des Produktaufklebers erfolgt auf eine dieser Arten:**

**1) Produkt-Schild aus Metall incl. Schrauben**

- Die Befestigung des Schildes erfolgt mittels der Schrauben.

**2) Aufkleber**

- Entfernen Sie zunächst Schmutz und Feuchtigkeit vom lackierten Metall bzw. von der Holzoberfläche und bringen Sie den Aufkleber wie im Bild oben rechts beschrieben auf den gesäuberten Untergrund auf.
- Beachten Sie: Bringen Sie den Aufkleber nicht auf raues laminiertes oder lackiertes Holz an.