

----- Falling Space 16.9 m2
Max Falling Height 550 mm

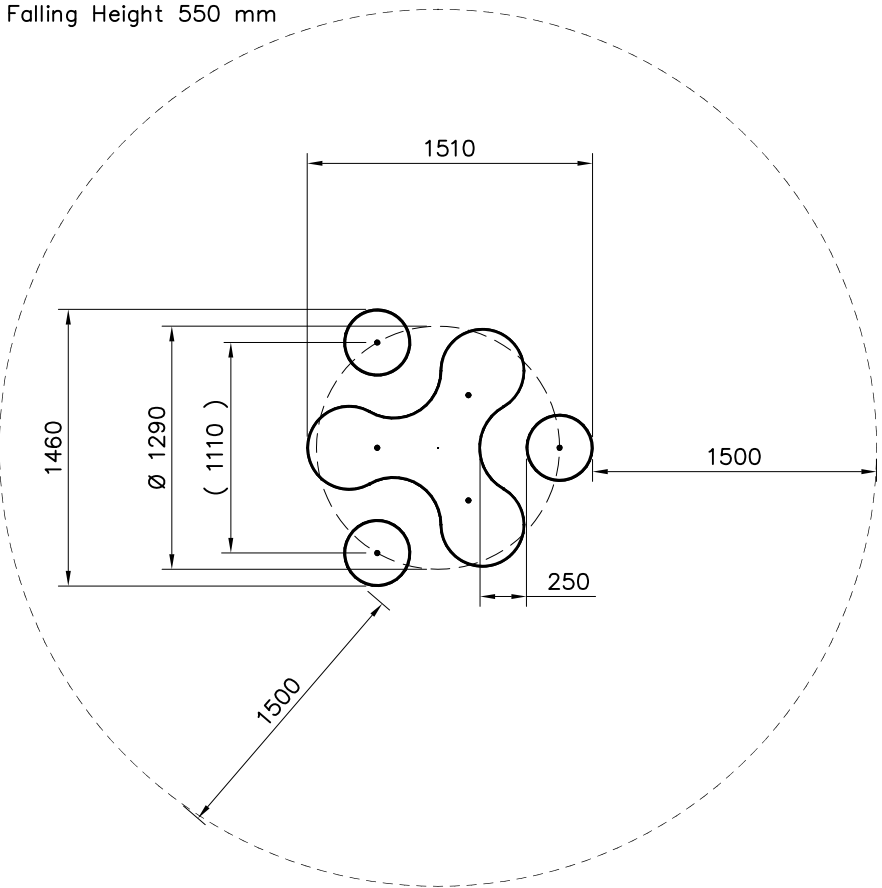

① P12292	PCS	② 702962	PCS
	1		3
15x1149x1258		Ø350x15	
③ 703072	PCS	④ 900958	PCS
	1		3
		M10x30	
⑤ 900965	PCS	⑥ 901302	PCS
	6		3
M10		Ø20/10.5x2	
⑦ 901487	PCS	⑧ 903580	PCS
	6		1
M10x40		L=1020	
⑨ 903585	PCS		PCS
	3		
L=858			
	PCS		PCS
	PCS		PCS
	PCS		PCS

