

LAPPSET®

THEME







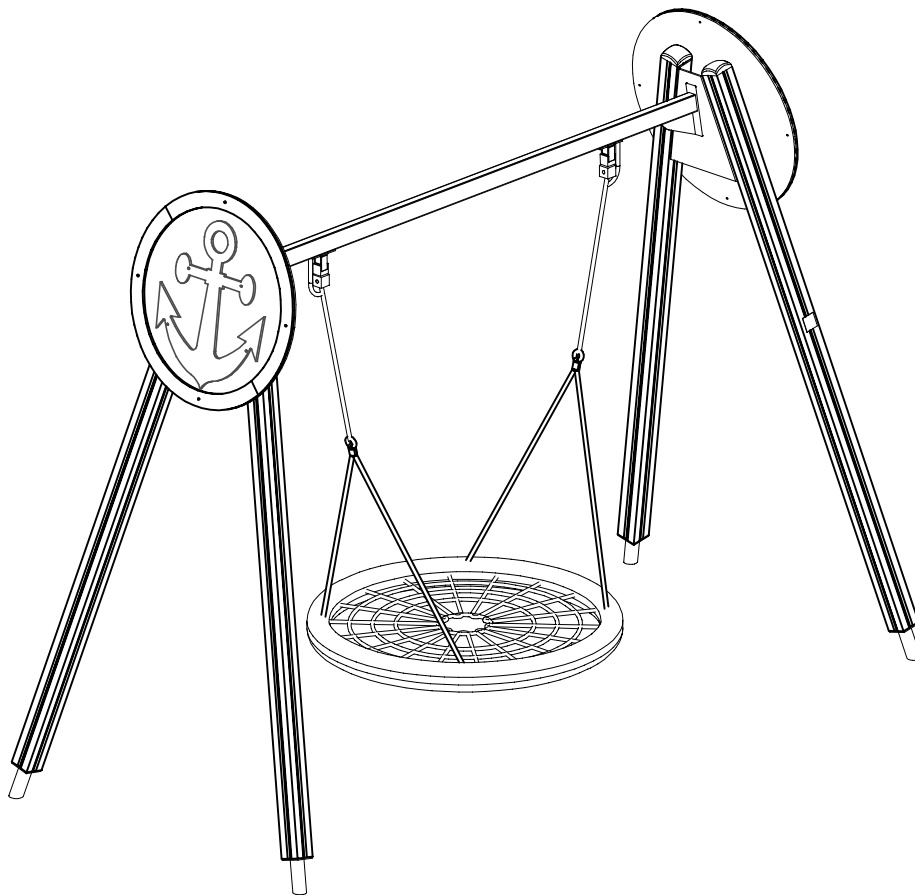







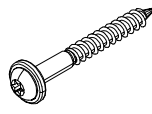

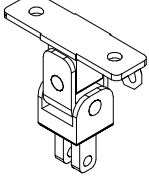

ASENNUSOHJE
MONTERINGSANSVISNING
INSTALLATION INSTRUCTION
AUFBAUANLEITUNG
NOTICE D'INSTALLATION

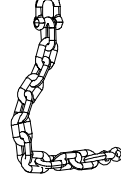
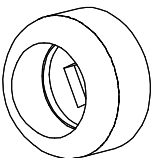
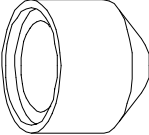
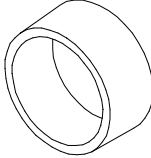
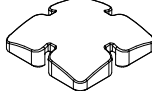
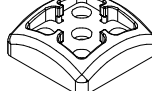
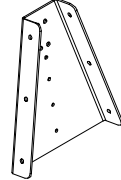
DATE: 6.7.2023

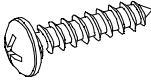
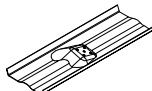
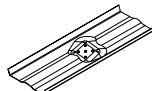
Q15353

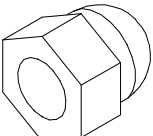
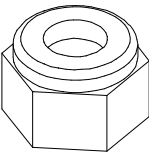
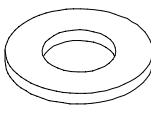
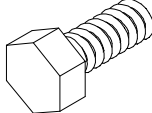
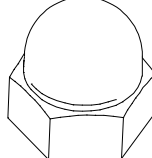

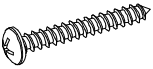
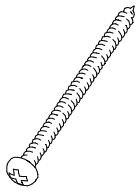
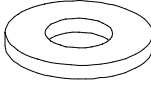
DATE: 4.2.2021

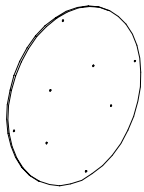
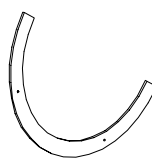
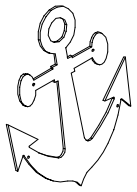
702286	PCS	702533	PCS	703248	PCS	706564-603	PCS	900240	PCS	900965	PCS
	1		1		1		4		8		4
65x65		118x78				L2650		Ø8x70		M10	
901958	PCS	901959	PCS	902234	PCS	903149	PCS	903577	PCS	905090	PCS
	2		1		4		4		2		12
		L2940		M12		M12x30				Ø45	
905104	PCS	905115	PCS	905138	PCS	905196	PCS	905991	PCS	906499	PCS
	16		12		4		4		2		4
M10		Ø30								M12x110	
909347	PCS	909506	PCS	909507	PCS	909508	PCS	909511	PCS	909633	PCS
	12		4		2		2		4		8
M12x35		Ø3.5x13		L 1000		L 1000		L650		M8	
909637	PCS	909638	PCS	909639	PCS	909644	PCS	909852	PCS	980114	PCS
	16		40		20		4		8		4
M10		Ø20/10.5		M10x25		M12		M8x30		Ø4x20	
980131	PCS	980154	PCS	999561	PCS	P15005	PCS	P15006	PCS	P15007	PCS
	16		28		1		2		4		2
Ø6x60		Ø24x13		10g							
	PCS		PCS		PCS		PCS		PCS		PCS

EN/AS Impact Area 19.9 m²

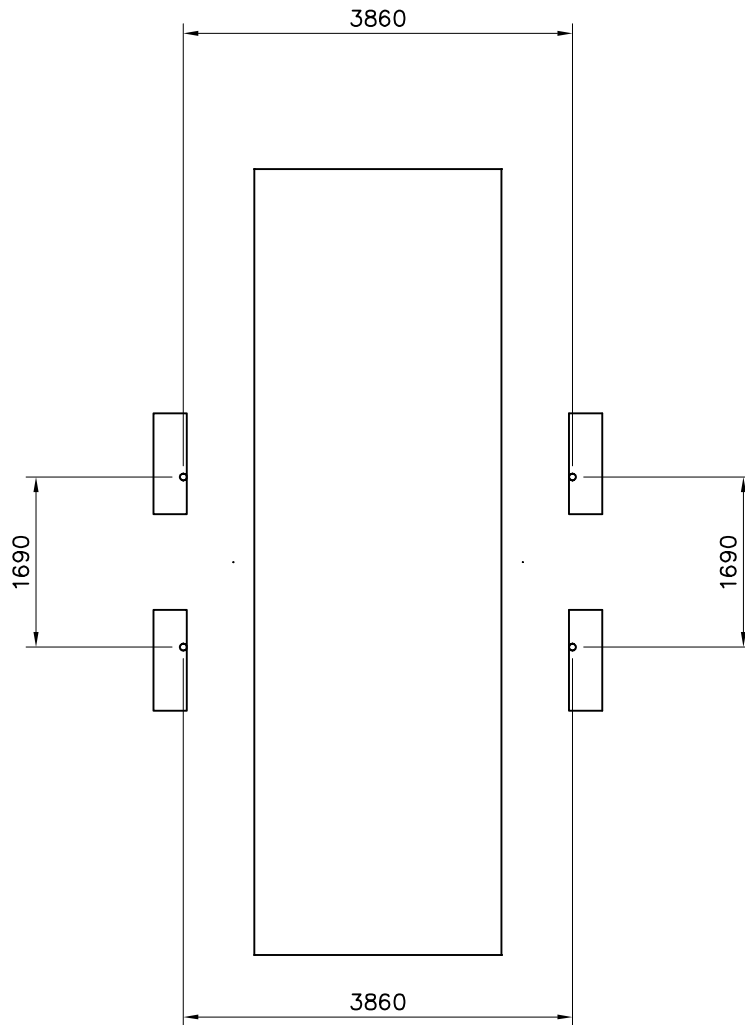
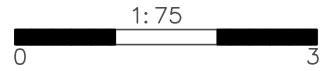

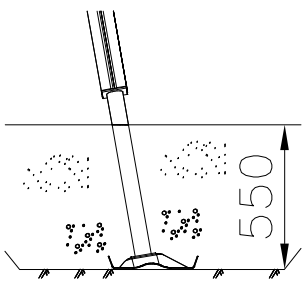
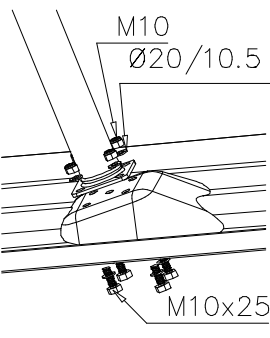
 <p>550</p>	 <p>M10 Ø20/10.5 M10x25</p>	

- EN/AS Impact Area 19.0 m²
- - - - Falling Space 19.0 m²
- Max Falling Height 1400 mm

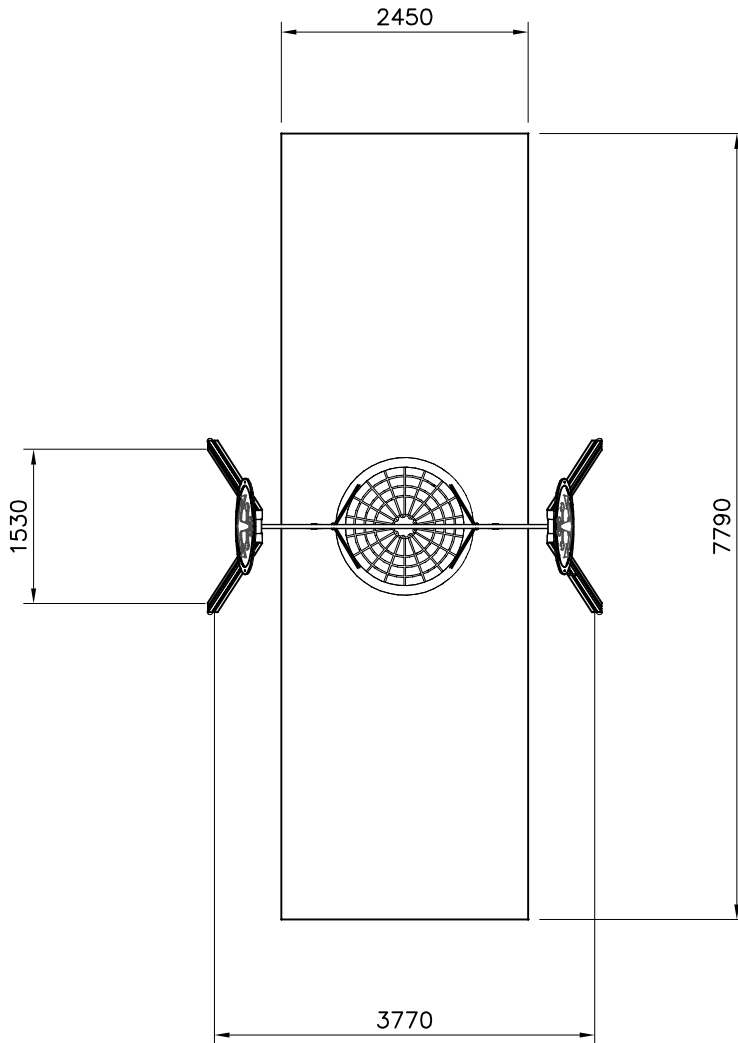
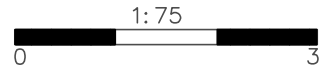

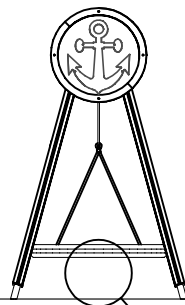
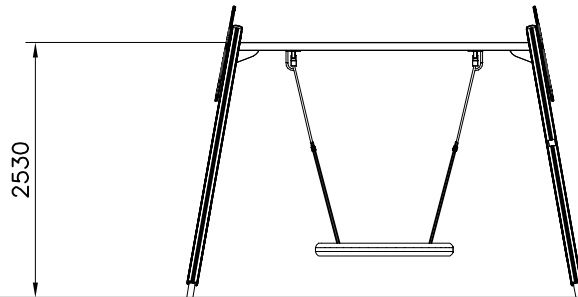

DET 5

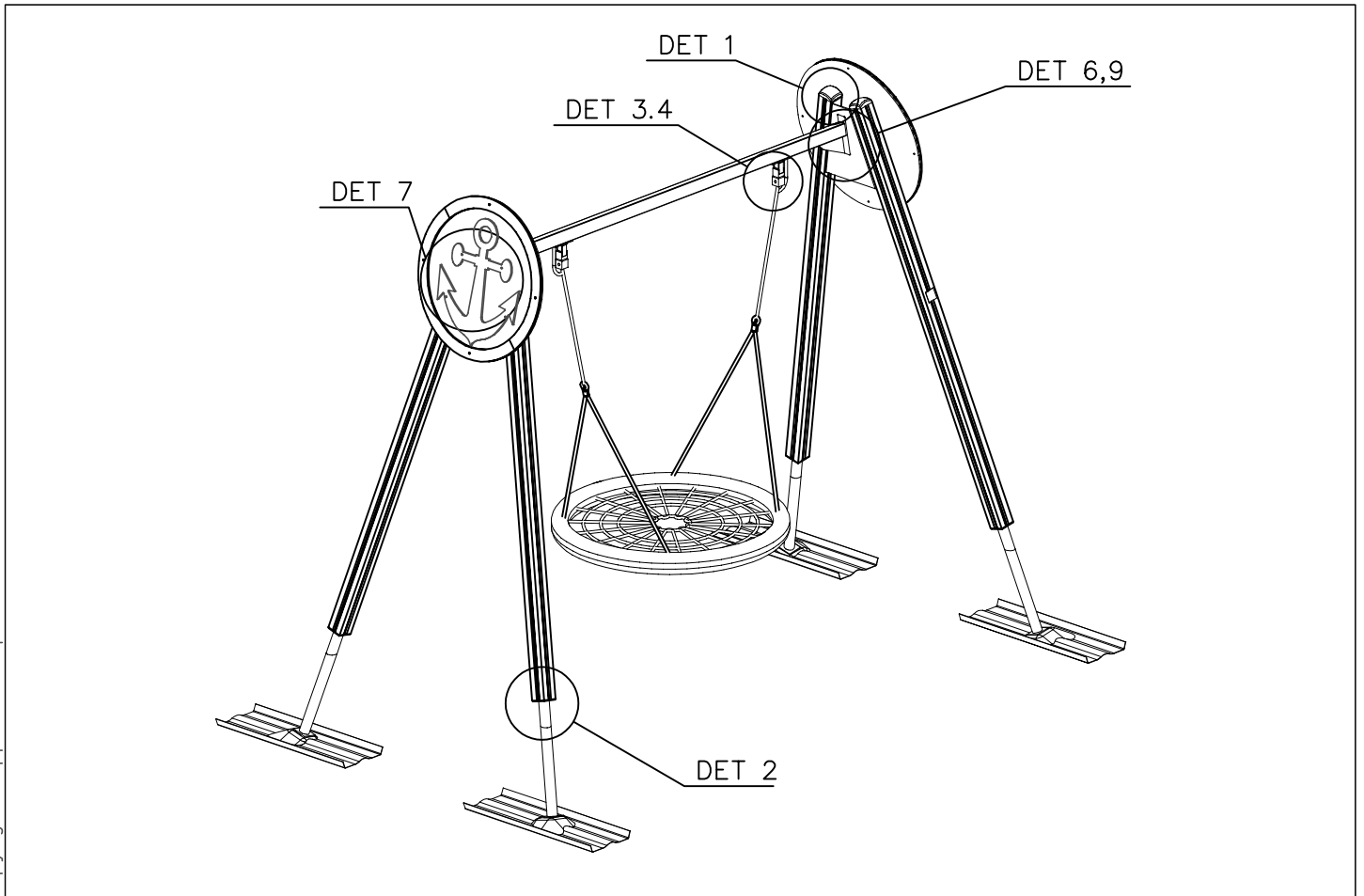
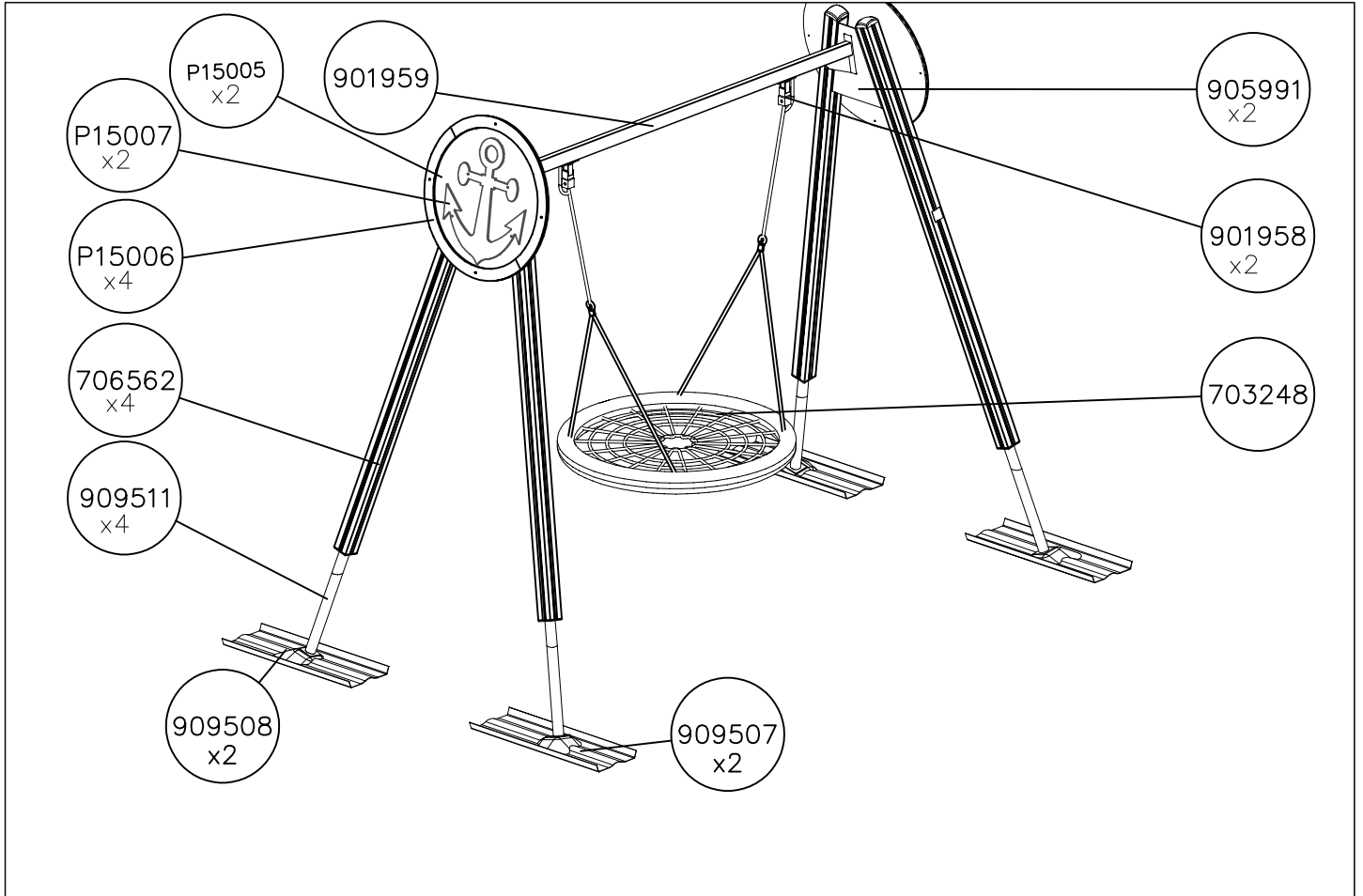

<p>DET 1</p> <p>6x60 980131</p>	<p>DET 2</p> <p>M10 905104 909521</p>	<p>DET 3</p> <p>901958 903577</p>	<p>DET 4</p> <p>M12x110 Ø24/13 901958 M8x35 Ø24/13 M12 M8 CUT EXTRA CHAIN</p>
<p>DET 5</p> <p>>400</p>	<p>DET 6</p> <p>M12 → 80 Nm Ø24/13 M12x30 M10x25 Ø20/10.5 M10 M10 → 45 Nm</p>	<p>DET 7</p> <p>909852 909633 900240</p>	
<p>DET 9</p> <p>999561 GLUE Ø24/13 12x35 905115 905090</p>			

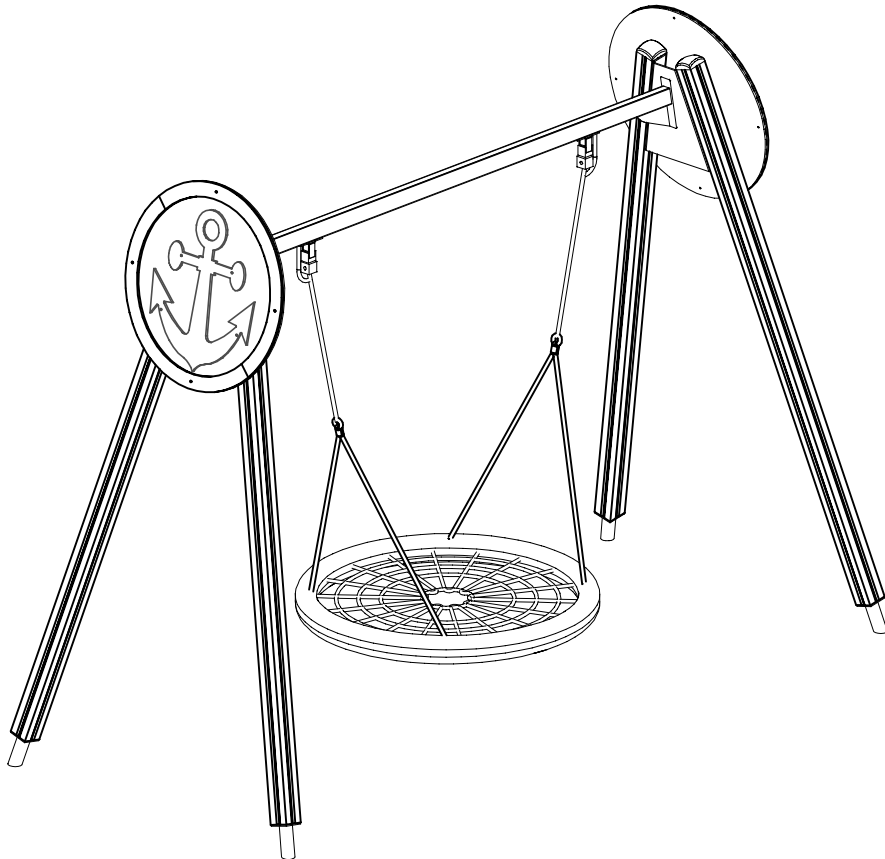
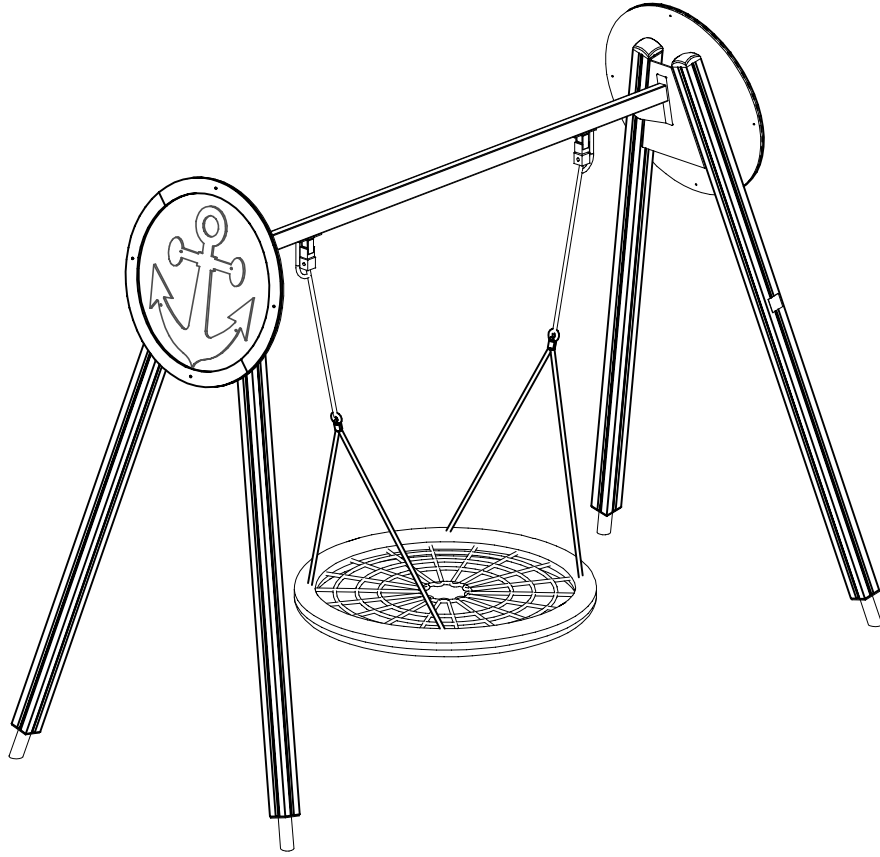

		
<p>$h < 600$</p> <p>Without movement and therefore without Impact Area</p>	<p>Totally hard surfaces.</p> <p>Note. Lappset does <u>not recommend</u> totally hard surfaces at all.</p>	<p>E.g. concrete or asphalt</p> 
<p>$h < 600$</p> <p>With movement e.g. rocking</p>	<p>Materials with very limited impact attenuating properties.</p>	<p>E.g. wood</p> 
<p>$h < 1000$</p>	<p>Materials with significant impact attenuating properties.</p>	<p>fine gravel 0–8 mm</p>  <p>grass</p>  <p>unsorted sand</p> 
<p>$h < 3000$</p>	<p>Loose fill material</p> <p>E.g. sand/gravel 0,25...8 mm D60/D10<3,0 Woodchips 5...30 mm bark 20...80 mm</p>	 <p>\underline{S} \underline{h}</p> <p>30 cm < 2,0 m</p> <p>40 cm < 3,0 m</p>
	<p>Syntethic granulates</p> <p>\underline{S} \underline{h}</p> <p>40 mm ~> 1,2...1,3 m</p> <p>50 mm ~> 1,5...1,7 m</p> <p>60 mm ~> 1,8...2,0 m</p> <p>70 mm ~> 2,1...2,5 m</p> <p>Note. For accurate values, see manufacturer's instructions.</p>	

REMOVE SAFETY SURFACE/SAND/GRAVEL
TO CHECK FOUNDATION



REMOVE SAFETY SURFACE/SAND/GRAVEL
TO CHECK FOUNDATION



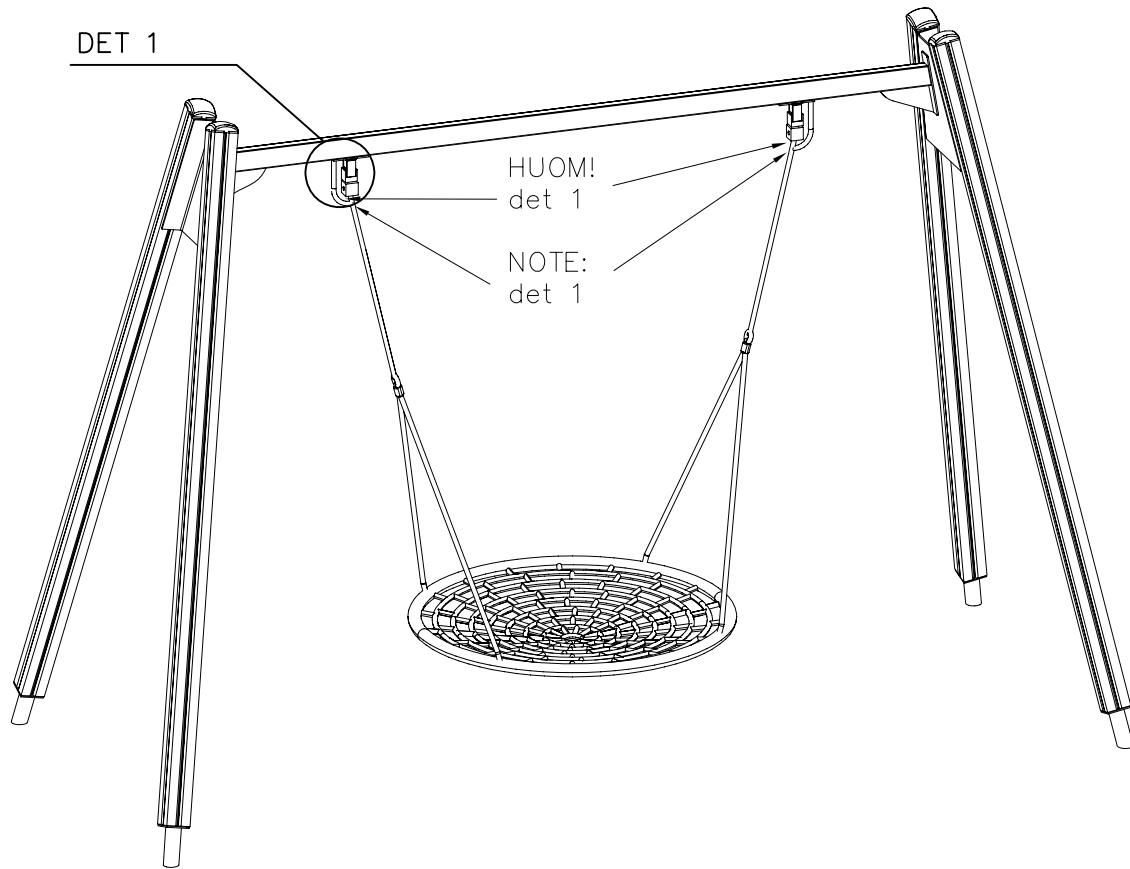

DET 1

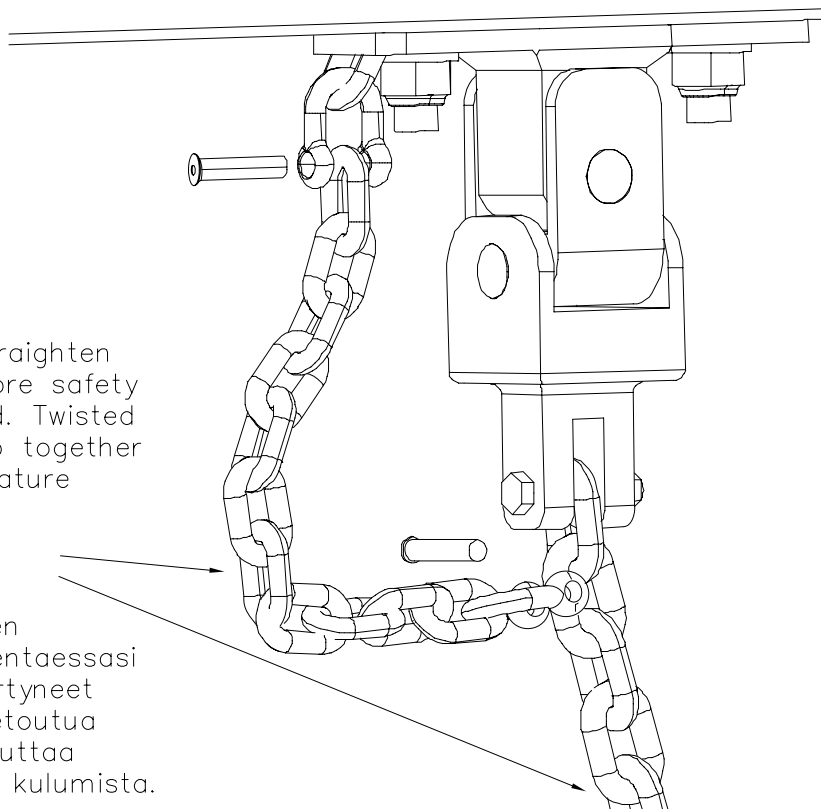

Note:
Make sure to straighten both chains before safety chain is installed. Twisted chains may wrap together and cause premature wear.

Huom!
Varmistu ketjujen suoruudesta asentaessasi turvaketjua. Kiertyneet ketjut voivat kietoutua toisiinsa ja aiheuttaa ketjujen nopeaa kulumista.

LAPPSET®
BETON FOUNDATION

FOOT

DATE: 27.10.2015

1(1)

② 905104	PCS		PCS
	4		
 M10	PCS		PCS



905104



Tuotekyltti tulee tuotteen mukana yhdellä seuraavista tavoista:

1) Metallinen tuotekyltti ja kiinnitysruuvit

- Kiinnitä tuotekyltti ruuveilla tolppaan noin 2 metrin korkeuteen kuvan 1 mukaisesti.

2) Tuotekylttitarra

- Puhdista maalattu metalli- tai vaneripinta pölystä ja kosteudesta. Liimaa tarra kuvan 2 mukaisesti.
- Huom. Älä kiinnitä tarraa karheapintaiseen laminaattiin tai maalattuun puuhun.

Vår produktmärkning levereras på ett av följande sätt:

1) Produktskylt i metall

- Fäst skylten med de medföljande skruvarna

2) Självhäftande produktetikett

- Rengör den pulverlackerade metallytan eller laminatyten så att den blir fri från smuts och fukt. Fäst etiketten enligt fig. 2.
- Obs! Fäst ej etiketten på detaljer med skrovlig yta eller på målat trä.

Product label is delivered by one of following ways:

1) Metal product label and screws

- Fasten the label with screws.

2) Label sticker

- Clean the painted metal or plywood surface from dirt and moisture. Fasten the sticker as shown in the figure 2.
- Note. Do not attach the sticker to rough surfaced laminate or painted wood.

La plaque d'informations produit est livrée sous l'une de ces 3 formes :

1) Plaque métallique et vis

- Fixez la plaque à l'aide des vis.

2) Etiquette autocollante

- Avant de coller l'étiquette, nettoyez le composant métallique peint ou la plaque de contreplaqué, de toute saleté. La surface doit être sèche (voir image 2).
- Attention, ne pas coller l'étiquette sur une surface lamellé-collée irrégulière ou sur du bois peint.

Die Auslieferung des Produktaufklebers erfolgt auf eine dieser Arten:

1) Produkt-Schild aus Metall incl. Schrauben

- Die Befestigung des Schildes erfolgt mittels der Schrauben.

2) Aufkleber

- Entfernen Sie zunächst Schmutz und Feuchtigkeit vom lackierten Metall bzw. von der Holzoberfläche und bringen Sie den Aufkleber wie im Bild oben rechts beschrieben auf den gesäuberten Untergrund auf.
- Beachten Sie: Bringen Sie den Aufkleber nicht auf raues laminiertes oder lackiertes Holz an.