

# LAPPSET®

## FLORA







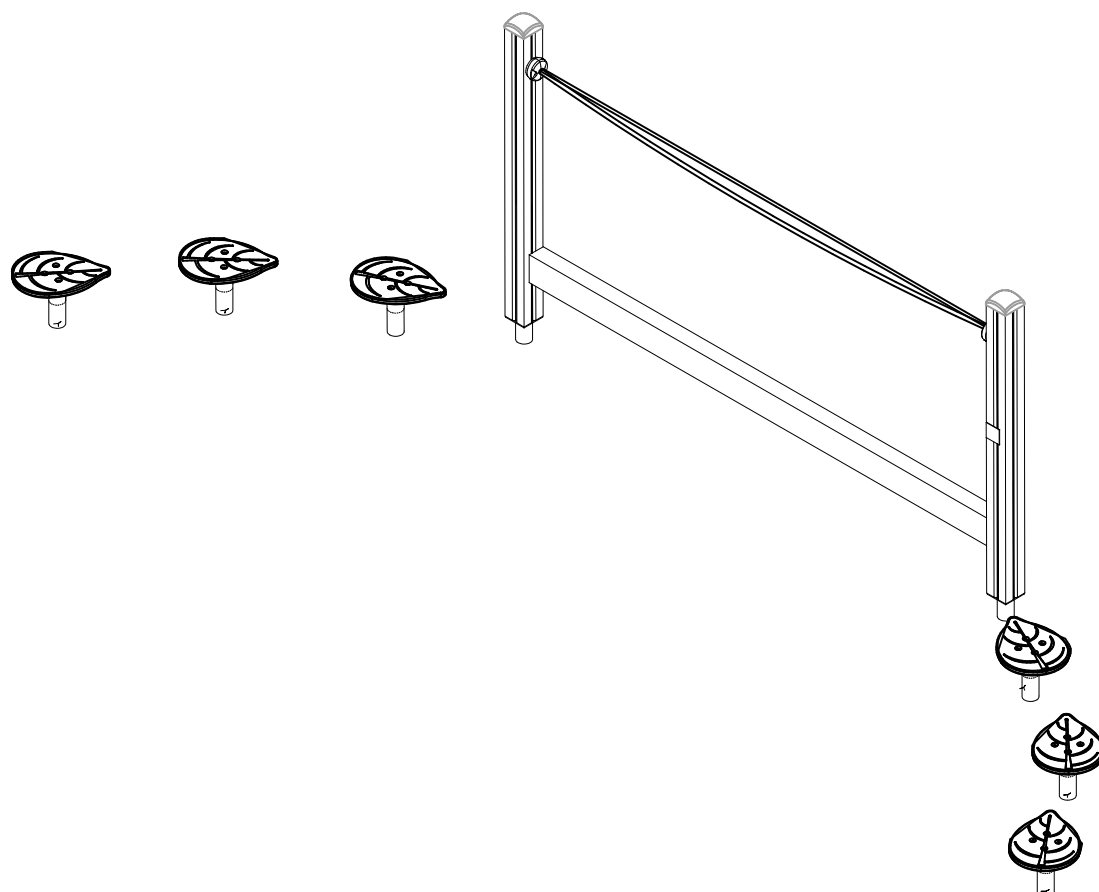

ASENNUSOHJE  
MONTERINGSANSVISNING  
INSTALLATION INSTRUCTION  
AUFBAUANLEITUNG  
NOTICE D'INSTALLATION

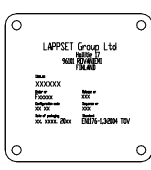
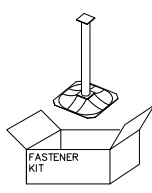
DATE: 26.7.2021

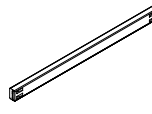
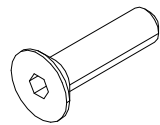
### Q15302

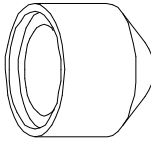
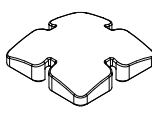
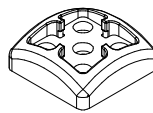

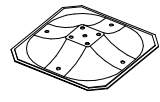
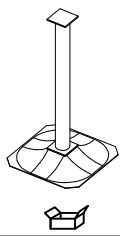
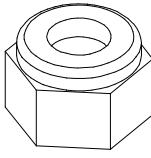
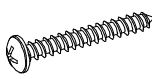
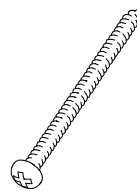
DATE: 26.7.2021

<p>701401</p>  <p>L 1250</p>	<p>PCS</p> <p>2</p>	<p>702286</p>  <p>65x65</p>	<p>PCS</p> <p>1</p>	<p>706531</p>  <p>FASTENER KIT</p>	<p>PCS</p> <p>2</p>	<p>707288-305</p>  <p>L 2305</p>	<p>PCS</p> <p>1</p>	<p>707294</p>  <p>70x120x2304</p>	<p>PCS</p> <p>1</p>	<p>901487</p>  <p>M10x40</p>	<p>PCS</p> <p>24</p>
<p>903093</p>  <p>Ø8x90</p>	<p>PCS</p> <p>8</p>	<p>905104</p>  <p>M10</p>	<p>PCS</p> <p>24</p>	<p>905138</p>  <p>GRAY</p>	<p>PCS</p> <p>2</p>	<p>905196</p>  <p>GRAY</p>	<p>PCS</p> <p>2</p>	<p>909511</p>  <p>90x90x650</p>	<p>PCS</p> <p>2</p>	<p>909519</p>  <p>50x380x380</p>	<p>PCS</p> <p>2</p>
<p>909521</p>  <p>Ø20/10,5</p>	<p>PCS</p> <p>6</p>	<p>909637</p>  <p>Ø20/10,5</p>	<p>PCS</p> <p>24</p>	<p>980114</p>  <p>Ø4x20</p>	<p>PCS</p> <p>4</p>	<p>980131</p>  <p>Ø6x60</p>	<p>PCS</p> <p>8</p>	<p>P03805</p>  <p>20x250x350</p>	<p>PCS</p> <p>6</p>	<p>PCS</p>	
	PCS		PCS		PCS		PCS		PCS		PCS
	PCS		PCS		PCS		PCS		PCS		PCS
	PCS		PCS		PCS		PCS		PCS		PCS
	PCS		PCS		PCS		PCS		PCS		PCS

EN/AS Impact Area 14.2 m<sup>2</sup>

Falling Space 20.3 m<sup>2</sup>

Max Falling Height 400 mm

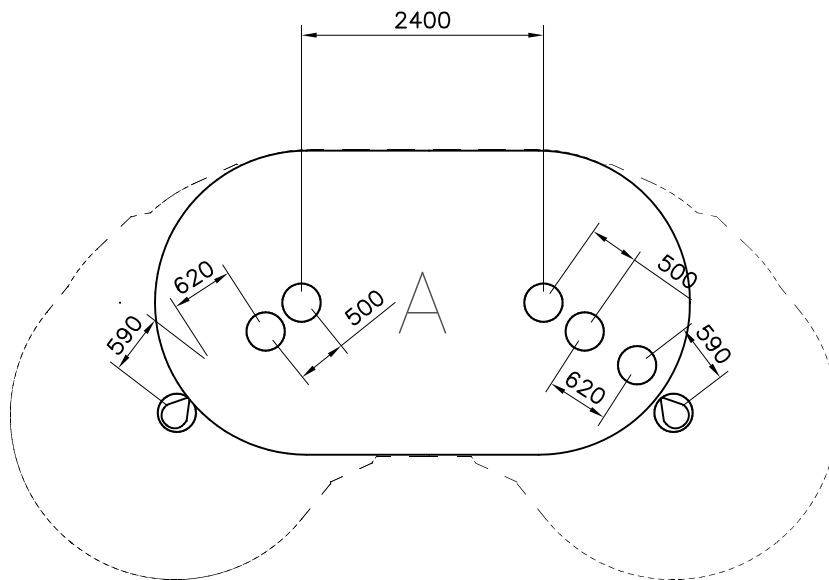
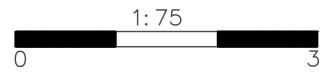

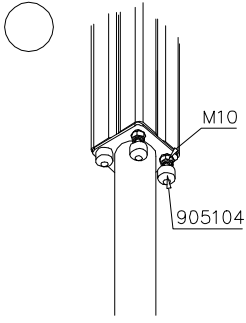
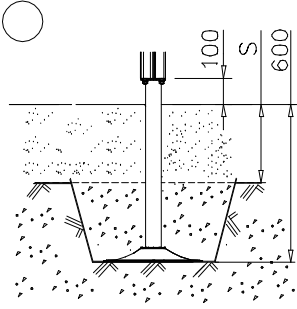
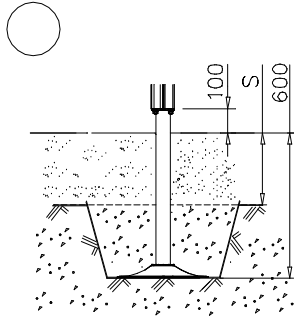

— Falling Space 26,6 m<sup>2</sup>  
Max Falling Height 400 mm

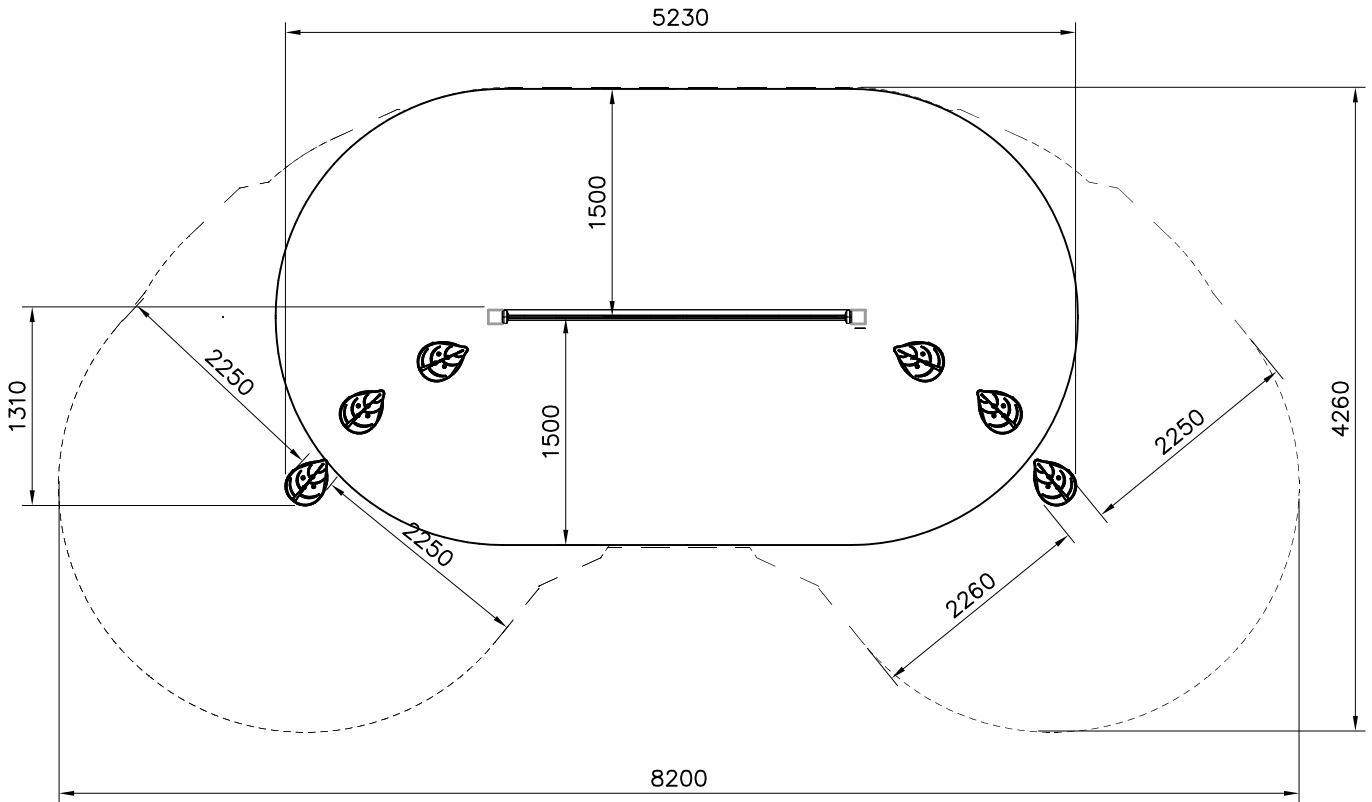

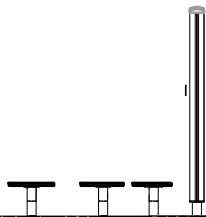
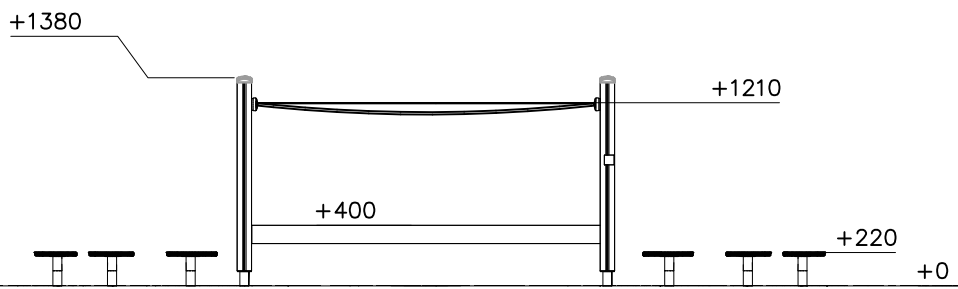

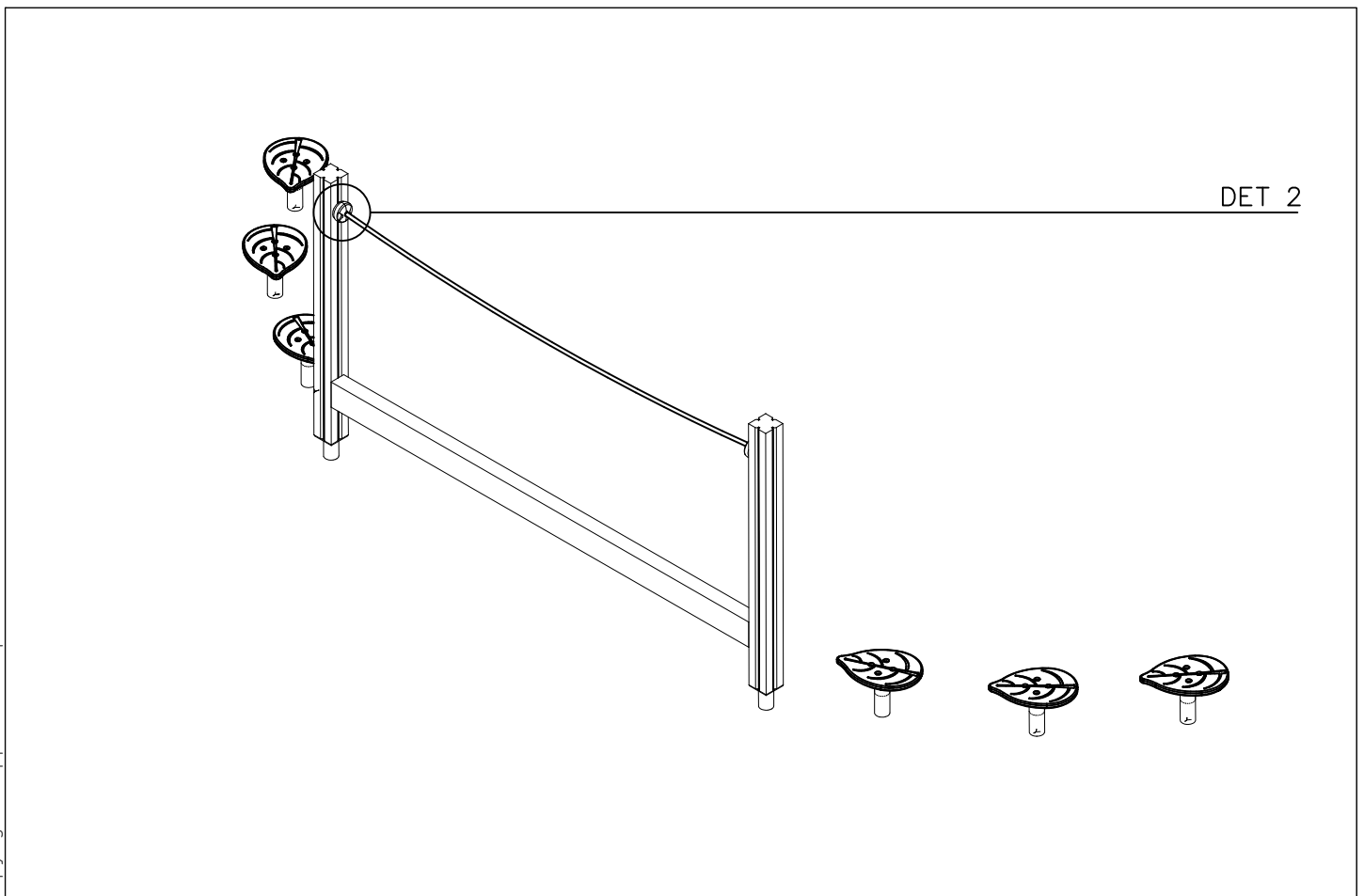
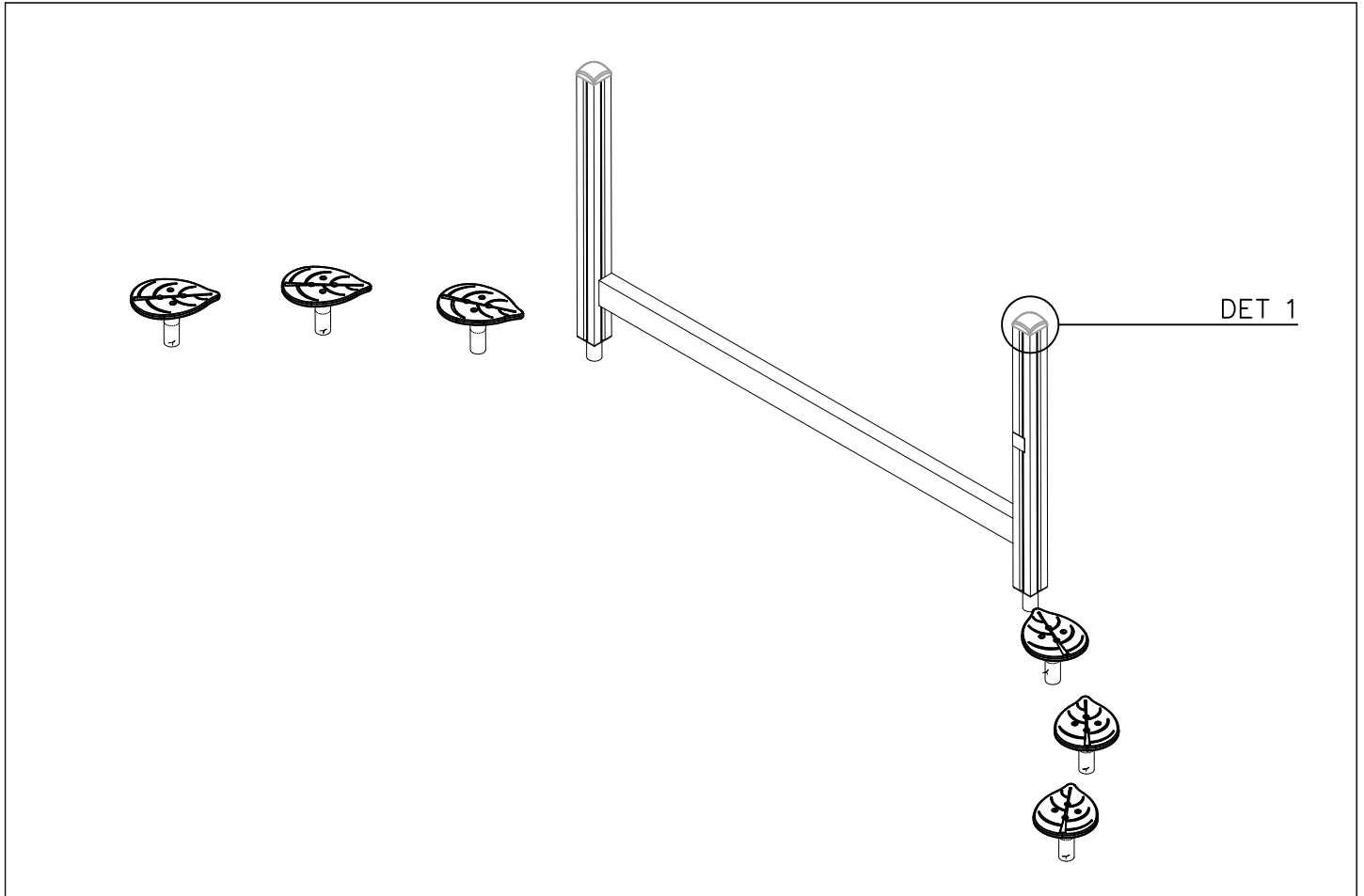

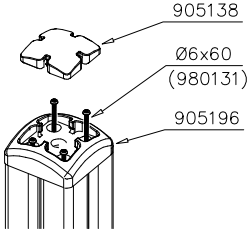
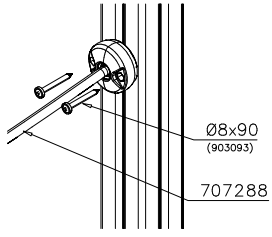
<p>DET 1</p>  <p>905138          Ø6x60          (980131)          905196</p>	<p>DET 2</p>  <p>Ø8x90          (903093)          707288</p>		



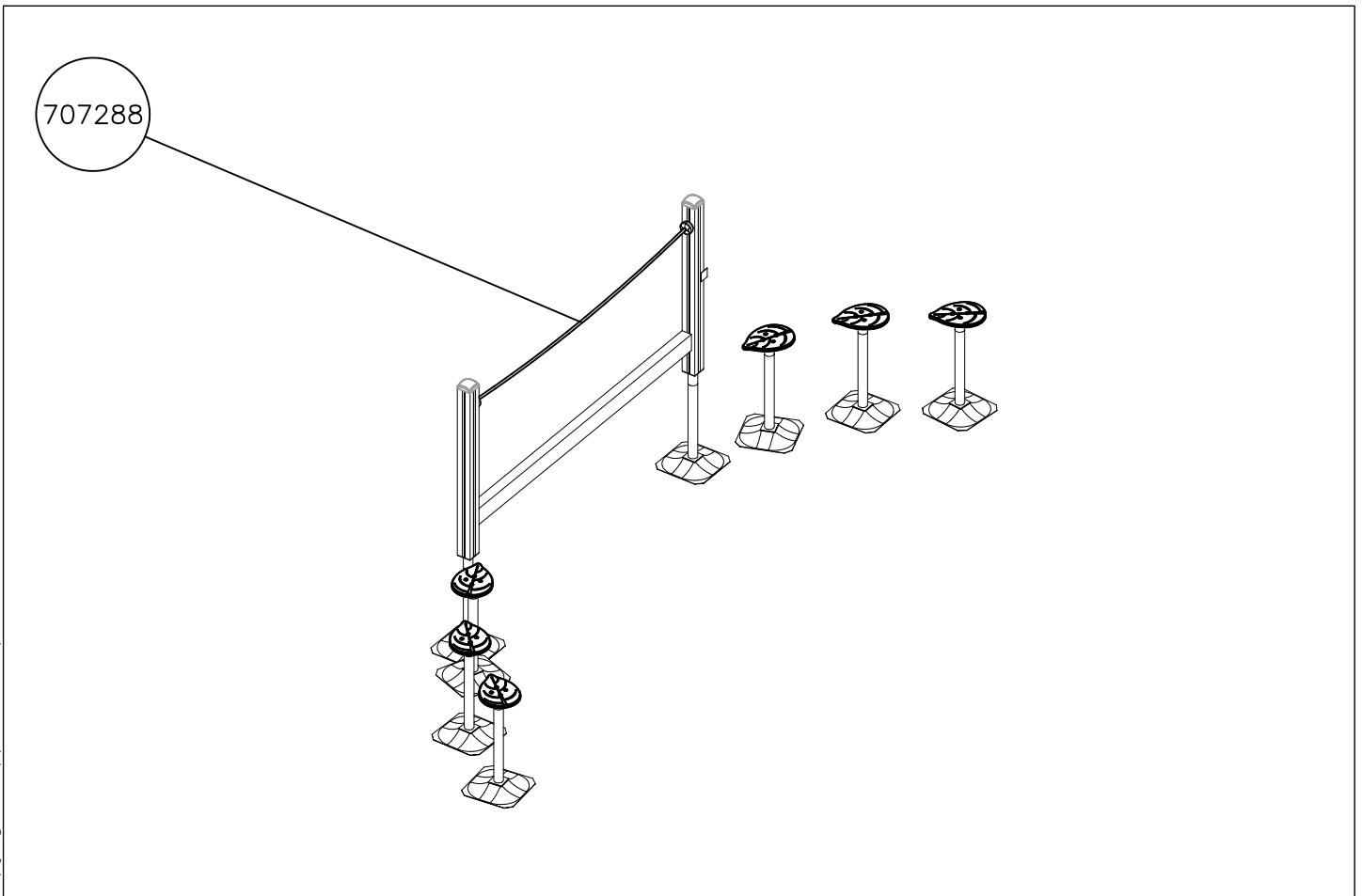
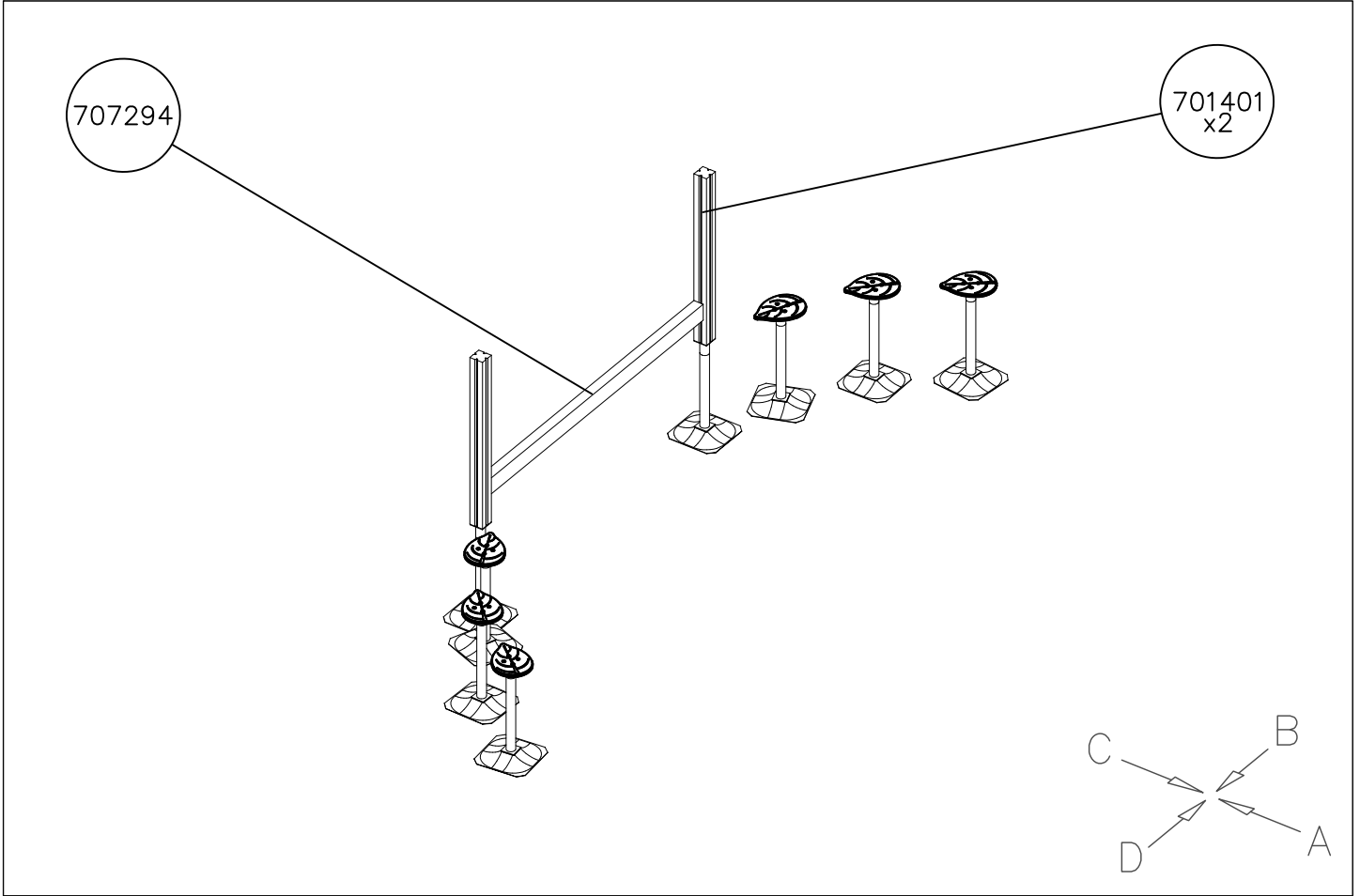





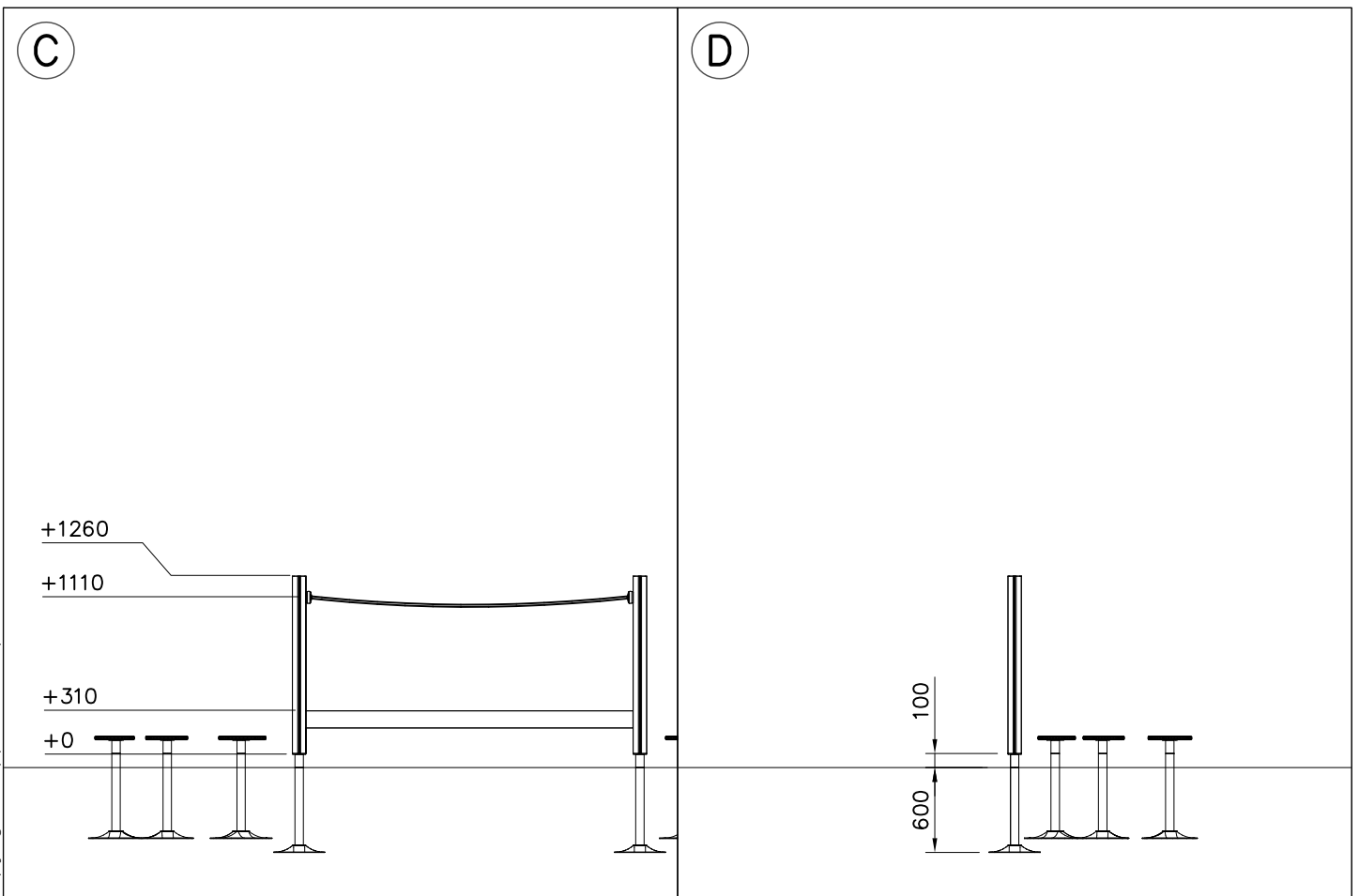
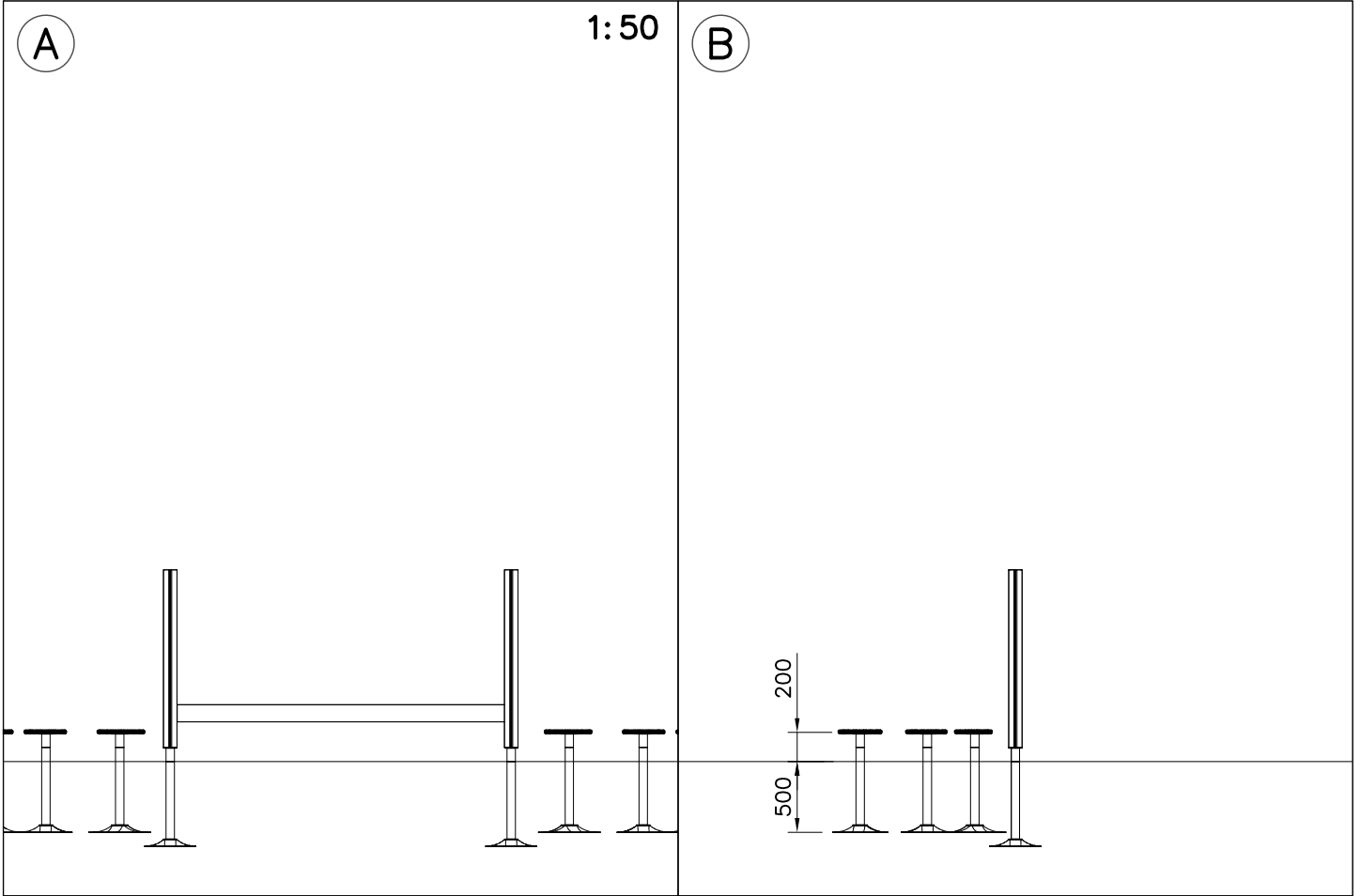

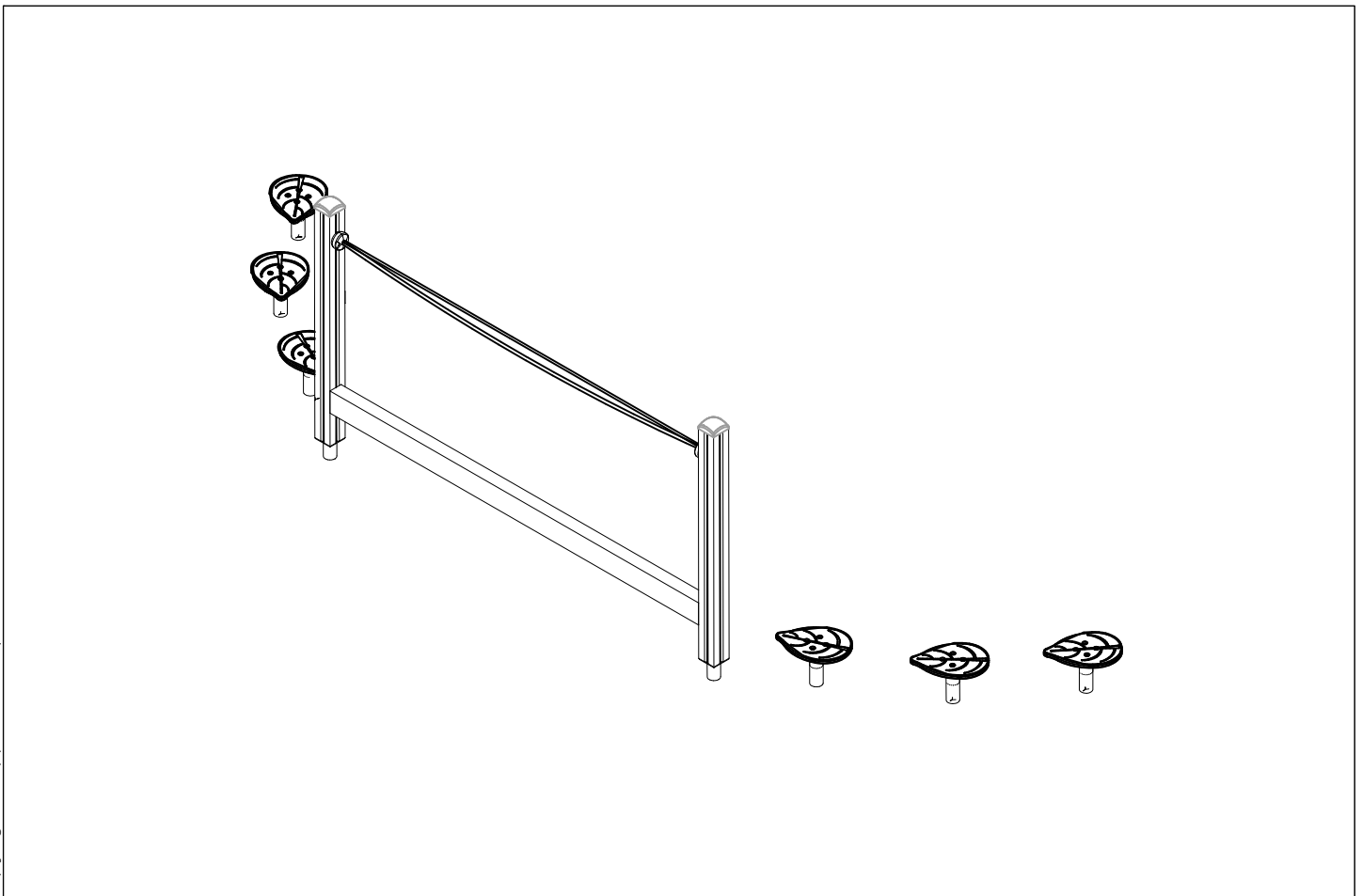
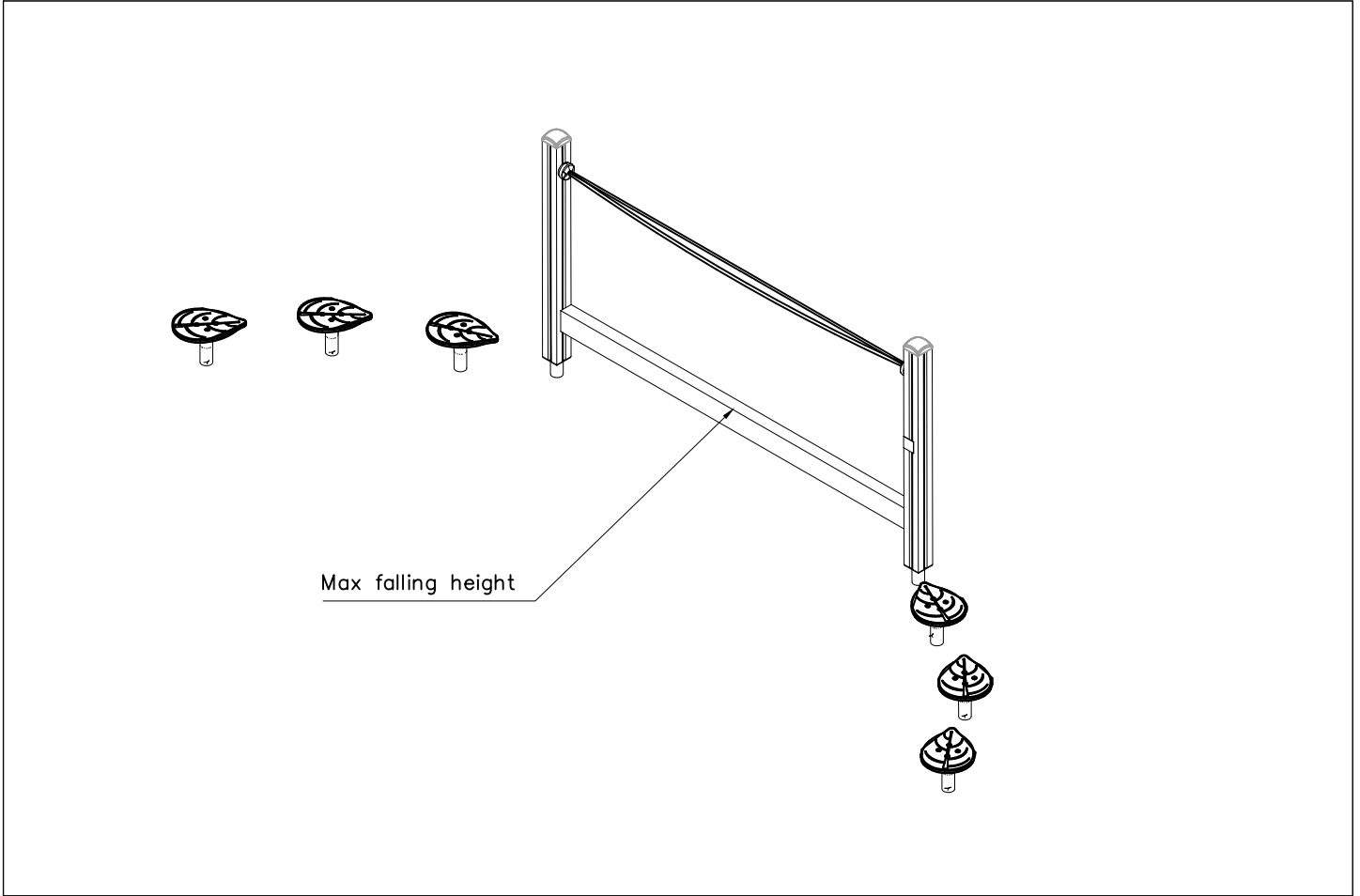
DATE: 26.7.2021

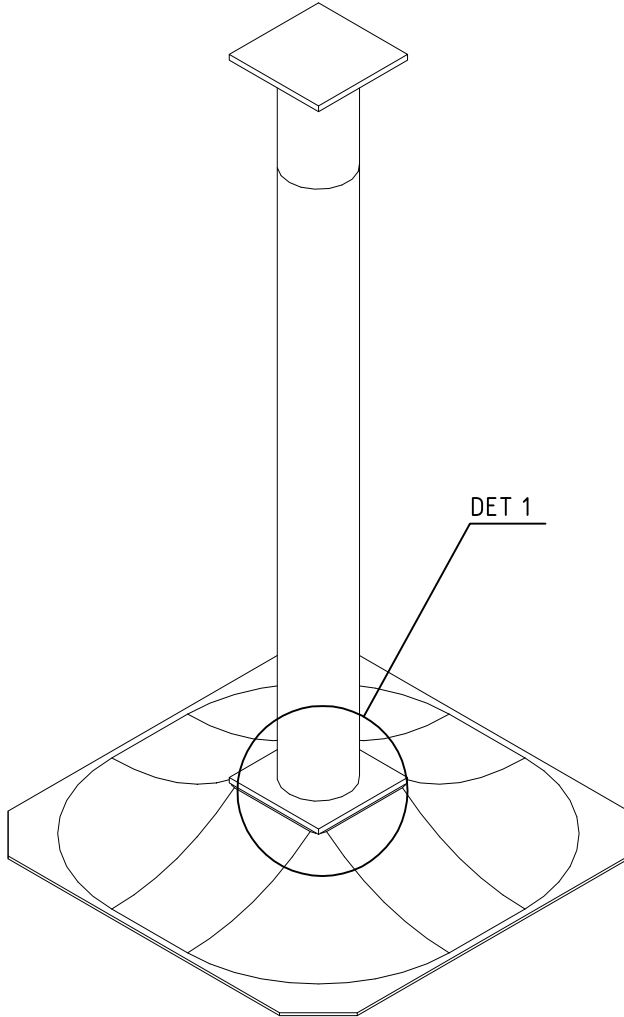
1:50



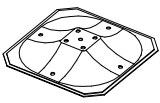



①	909511	PCS	②	909519	PCS
		1			1
③	909637	PCS	④	909638	PCS
		4			8
	M10			Ø20/10.5	
⑤	909639	PCS			PCS
		4			
	M10x25				
		PCS			PCS
		PCS			PCS
		PCS			PCS
		PCS			PCS
		PCS			PCS

DET 1

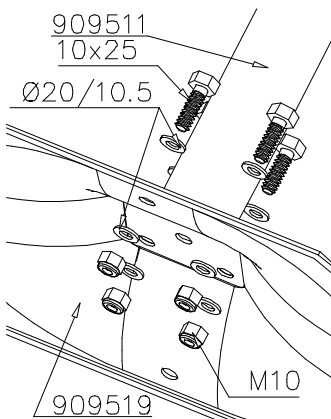



**Tuotekyltti tulee tuotteen mukana yhdellä seuraavista tavoista:****1) Metallinen tuotekyltti ja kiinnitysruuvit**

- Kiinnitä tuotekyltti ruuveilla tolppaan noin 2 metrin korkeuteen kuvan 1 mukaisesti.

**2) Tuotekylttitarra**

- Puhdista maalattu metalli- tai vaneripinta pölystä ja kosteudesta. Liimaa tarra kuvan 2 mukaisesti.
- Huom. Älä kiinnitä tarraa karheapintaiseen laminaattiin tai maalattuun puuhun.

**Vår produktmärkning levereras på ett av följande sätt:****1) Produktskylt i metall**

- Fäst skylten med de medföljande skruvarna

**2) Självhäftande produktetikett**

- Rengör den pulverlackerade metallytan eller laminatyten så att den blir fri från smuts och fukt. Fäst etiketten enligt fig. 2.
- Obs! Fäst ej etiketten på detaljer med skrovlig yta eller på målat trä.

**Product label is delivered by one of following ways:****1) Metal product label and screws**

- Fasten the label with screws.

**2) Label sticker**

- Clean the painted metal or plywood surface from dirt and moisture. Fasten the sticker as shown in the figure 2.
- Note. Do not attach the sticker to rough surfaced laminate or painted wood.

**La plaque d'informations produit est livrée sous l'une de ces 3 formes :****1) Plaque métallique et vis**

- Fixez la plaque à l'aide des vis.

**2) Etiquette autocollante**

- Avant de coller l'étiquette, nettoyez le composant métallique peint ou la plaque de contreplaqué, de toute saleté. La surface doit être sèche (voir image 2).
- Attention, ne pas coller l'étiquette sur une surface lamellé-collée irrégulière ou sur du bois peint.

**Die Auslieferung des Produktaufklebers erfolgt auf eine dieser Arten:****1) Produkt-Schild aus Metall incl. Schrauben**

- Die Befestigung des Schildes erfolgt mittels der Schrauben.

**2) Aufkleber**

- Entfernen Sie zunächst Schmutz und Feuchtigkeit vom lackierten Metall bzw. von der Holzoberfläche und bringen Sie den Aufkleber wie im Bild oben rechts beschrieben auf den gesäuberten Untergrund auf.
- Beachten Sie: Bringen Sie den Aufkleber nicht auf raues laminiertes oder lackiertes Holz an.



**LAPPSET®**  
**BETON FOUNDATION**

**FOOT**

DATE: 27.10.2015

**1(1)**

② 905104	PCS		PCS
	4		
 M10	PCS		PCS



905104



# LAPPSET® DEEP FOUNDATION

# FOOT

DATE: 15.5.2018

1(1)



①	909511	PCS	②	909519	PCS
		1			1
	90x90x650			50x380x380	
③	909637	PCS	④	909638	PCS
		4			8
	M10			Ø20/10.5	
⑤	909639	PCS	⑥	905104	PCS
		4			4
	M10x25			M10	
OPTION FOOT					
①	911155	PCS			PCS
		1			
	90x90x650				