

EN1176 Max falling height is 2420 mm.
EN1663 Max falling height is $2420 - 1000 = 1420$ mm

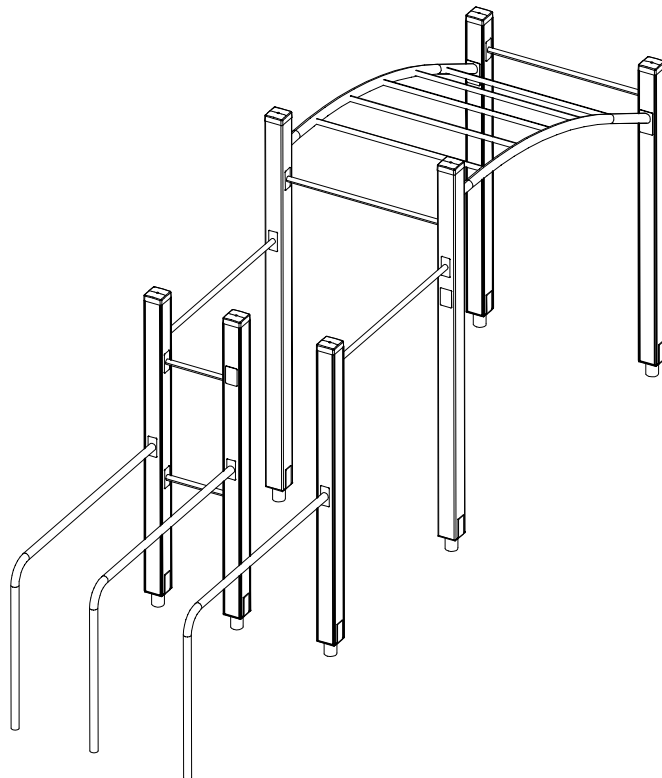

—— EN/AS Impact Area 42.2 m²

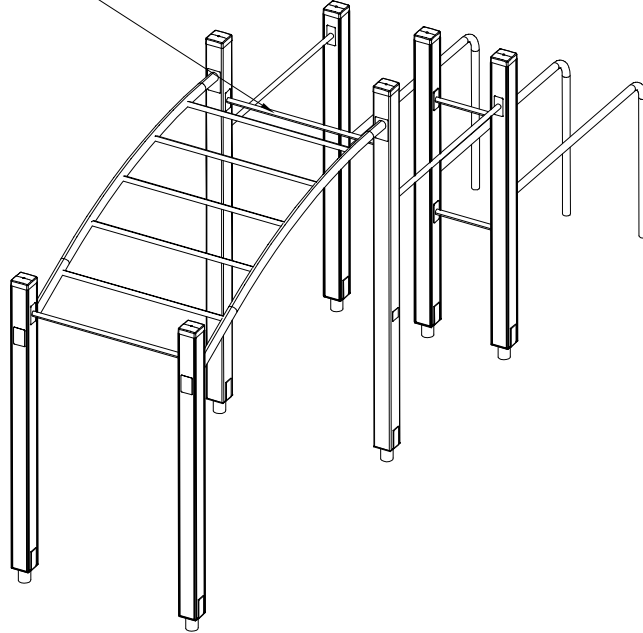



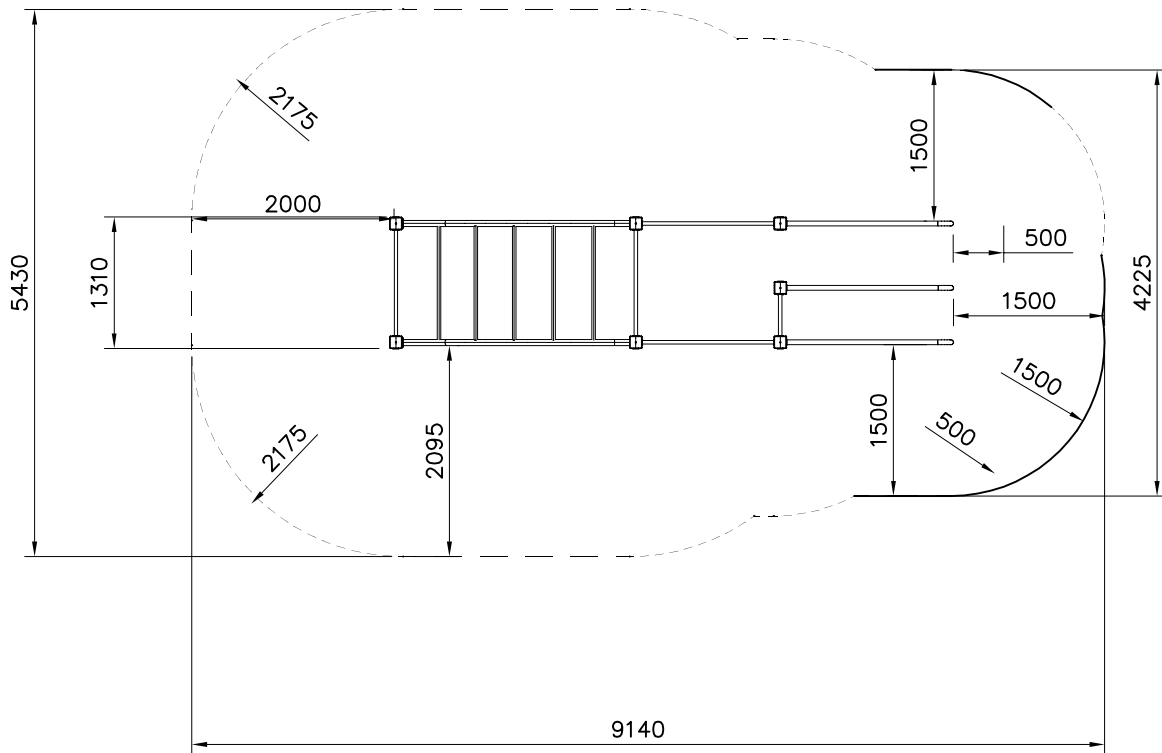
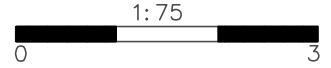

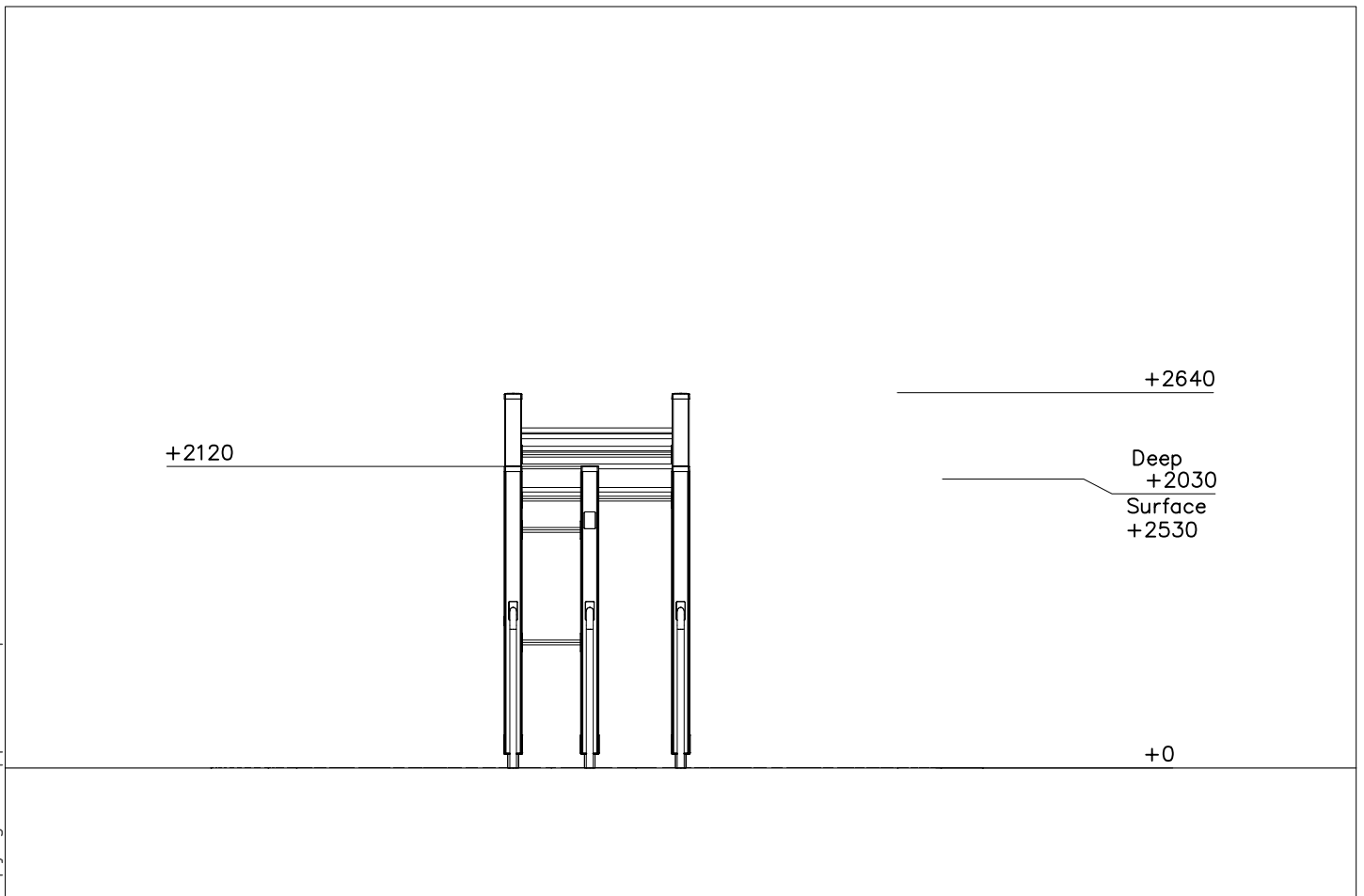
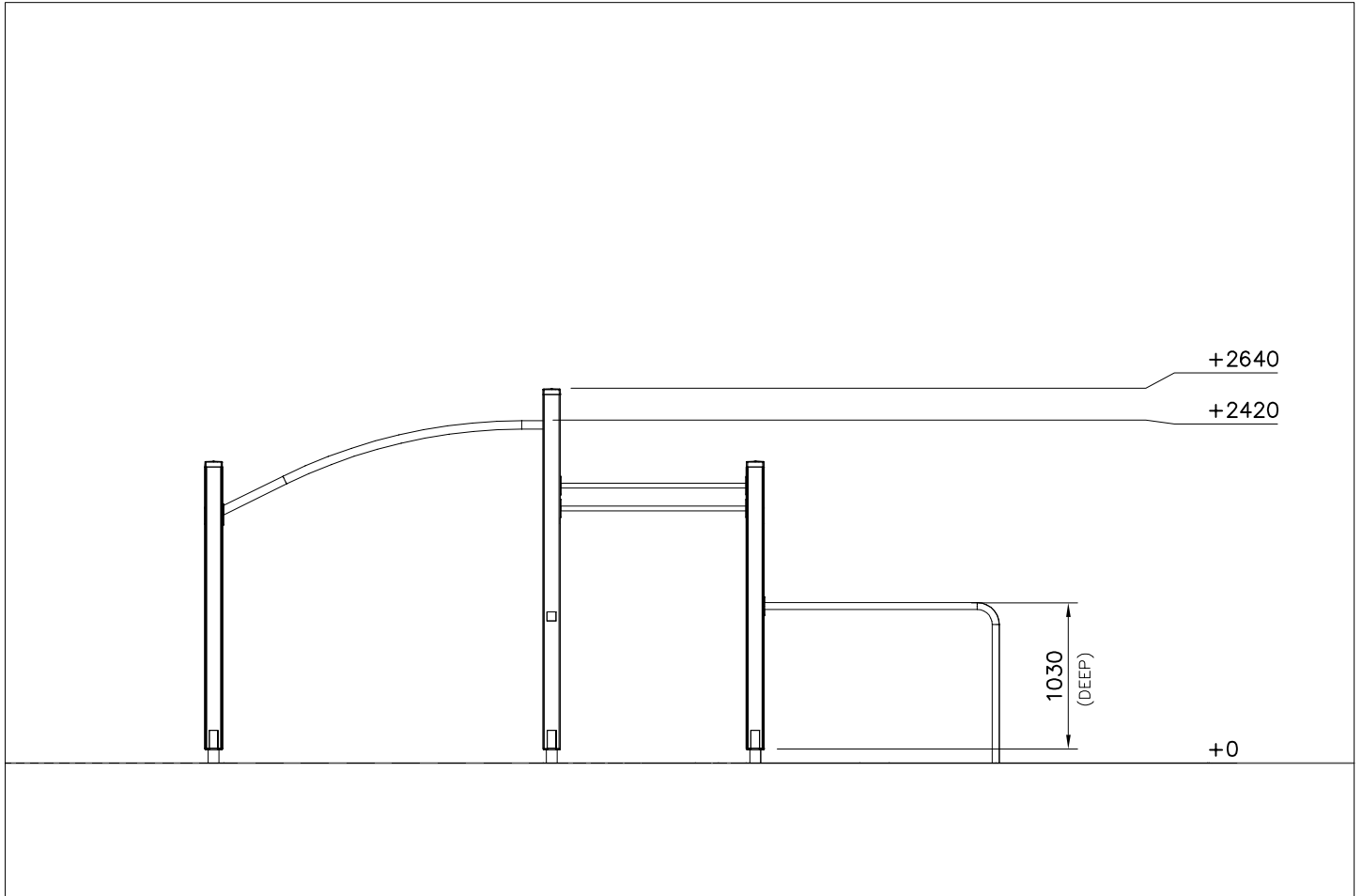

----- Falling Space 42.2 m²

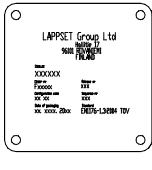
EN1176 Max falling height is 2420 mm.
EN1663 Max falling height is 2420 - 1000 = 1420 mm

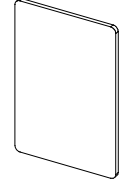
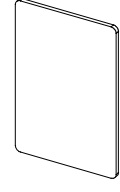
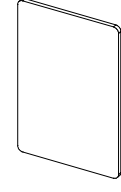

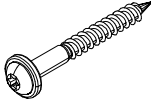
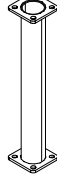

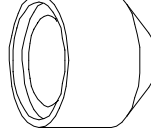
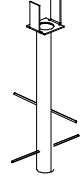
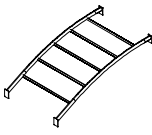
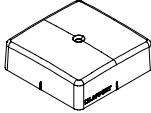
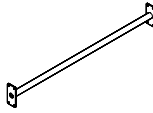
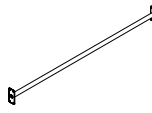
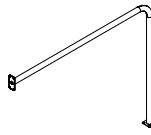
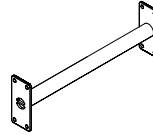
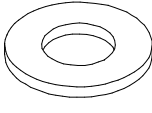
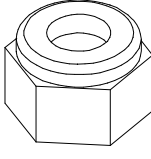
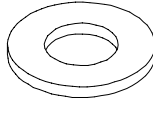
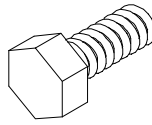
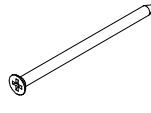
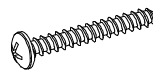
DATE: 8.12.2020

702286  65x65	PCS 1	705322  118x118x2500	PCS 2	705347  118x118x1990	PCS 5	707881  118x78	PCS 1	707882  118x78	PCS 1	707883  118x78	PCS 1
707884  118x78	PCS 1	900240  Ø8x70	PCS 16	902272  90x90x450	PCS 3	903093  Ø8x90	PCS 12	905104  M10	PCS 28	905761  120x120x700	PCS 7
905800-216  2260x600x1270	PCS 1	905830  123x123x40	PCS 7	905838-216  L 1060	PCS 2	908017-216  L 1315	PCS 2	908019-216  1500x1200	PCS 3	908062-216  L 420	PCS 2
909256  Ø16/8.4	PCS 76	909637  M10	PCS 12	909638  Ø20/10.5	PCS 24	909639  M10x25	PCS 12	980104  Ø5x90	PCS 7	980114  Ø4x20	PCS 20
980123  Ø7x60	PCS 76		PCS		PCS		PCS		PCS		PCS
	PCS		PCS		PCS		PCS		PCS		PCS
	PCS		PCS		PCS		PCS		PCS		PCS