

# LAPPSET®

## FINNO







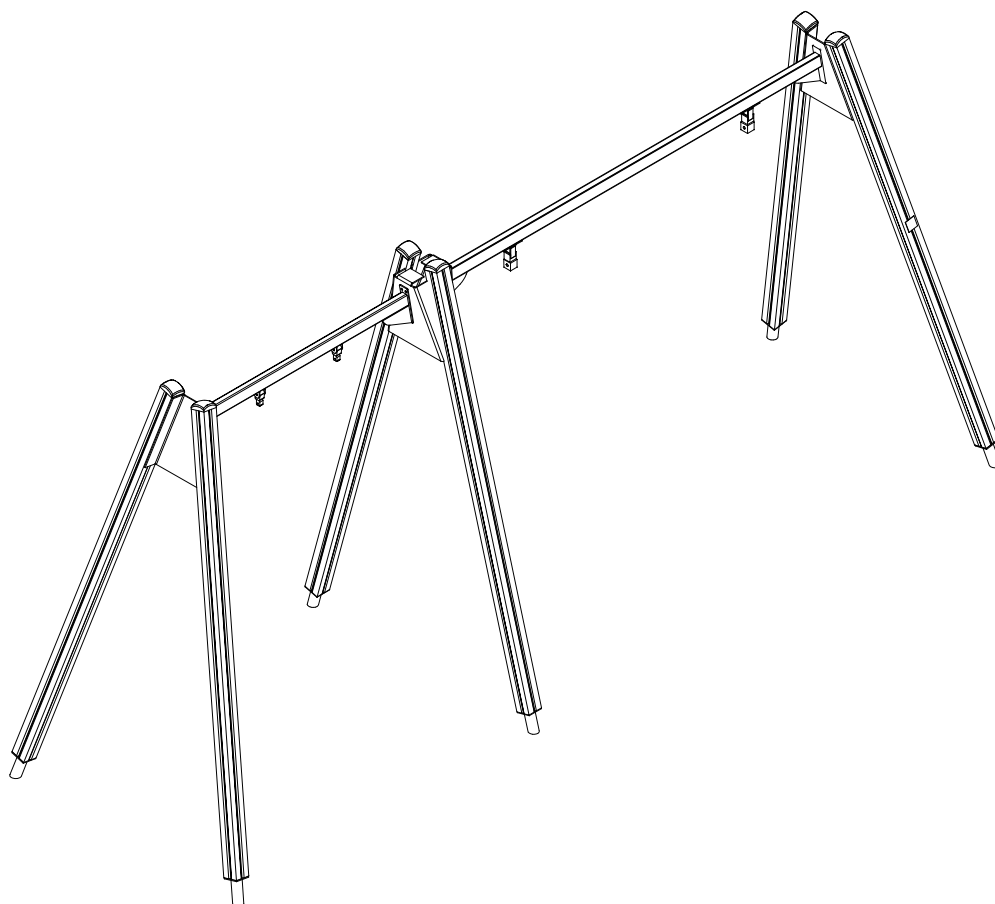



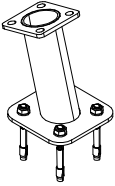
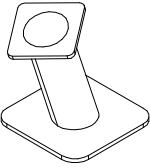
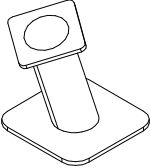
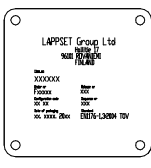



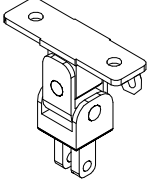

ASENNUSOHJE  
MONTERINGSANSVISNING  
INSTALLATION INSTRUCTION  
AUFBAUANLEITUNG  
NOTICE D'INSTALLATION

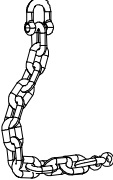
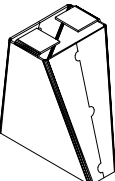
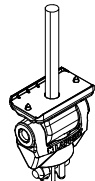
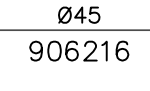
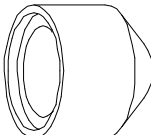
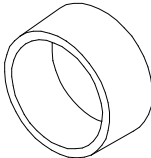
DATE: 3.9.2020

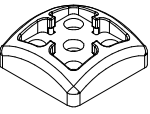
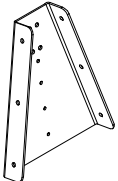
### Q11576-7

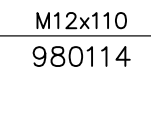

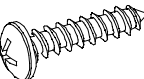
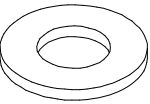
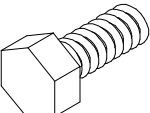
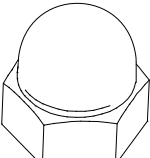
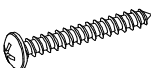
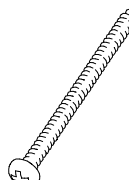
DATE: 3.9.2020

 701900 L 150	PCS 2	 701902 L 150	PCS 2	 701903 L 150	PCS 2	 702286 65x65	PCS 1	 702533 118x78	PCS 1	 706564 L2650	PCS 6
 900965 M10	PCS 8	 901958	PCS 2	 901959 L2940	PCS 1	 902234 M12	PCS 4	 903149 M12x30	PCS 8	 903577	PCS 2
 904317	PCS 1	 904904	PCS 2	 905090 Ø45	PCS 18	 905104 M10	PCS 24	 905115 Ø30	PCS 18	 905138	PCS 6
 905196	PCS 6	 905991	PCS 2	 906216 L1690	PCS 1	 906499 M12x110	PCS 4	 909347 M12x35	PCS 18	 909506 Ø3.5x13	PCS 4
 909638 Ø20/10.5	PCS 16	 909639 M10x25	PCS 8	 909644 M12	PCS 8	 980114 Ø4x20	PCS 4	 980131 Ø6x60	PCS 24	 980154 Ø24/13	PCS 42
 999561 10g	PCS 1		PCS		PCS		PCS		PCS		PCS
	PCS		PCS		PCS		PCS		PCS		PCS

- EN/AS Impact Area 34.3 m<sup>2</sup>
- Falling Space 34.3 m<sup>2</sup>
- Max Falling Height 1400 mm

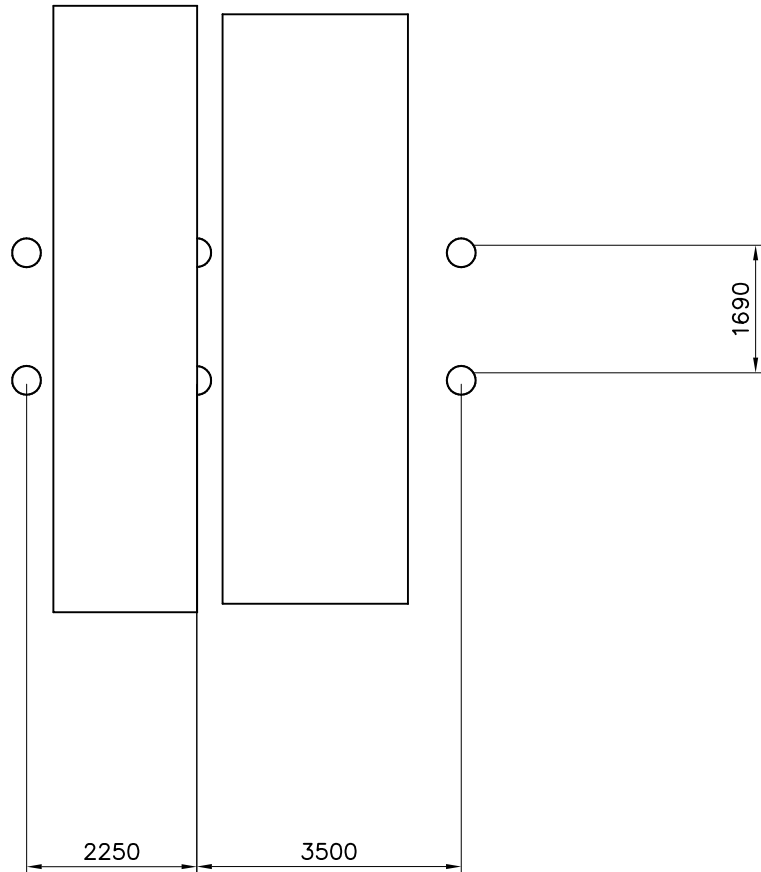
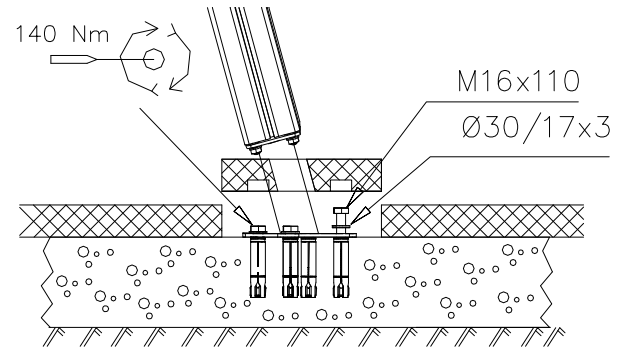

- EN/AS Impact Area 34.3 m<sup>2</sup>
- Falling Space 34.3 m<sup>2</sup>  
Max Falling Height 1400 mm

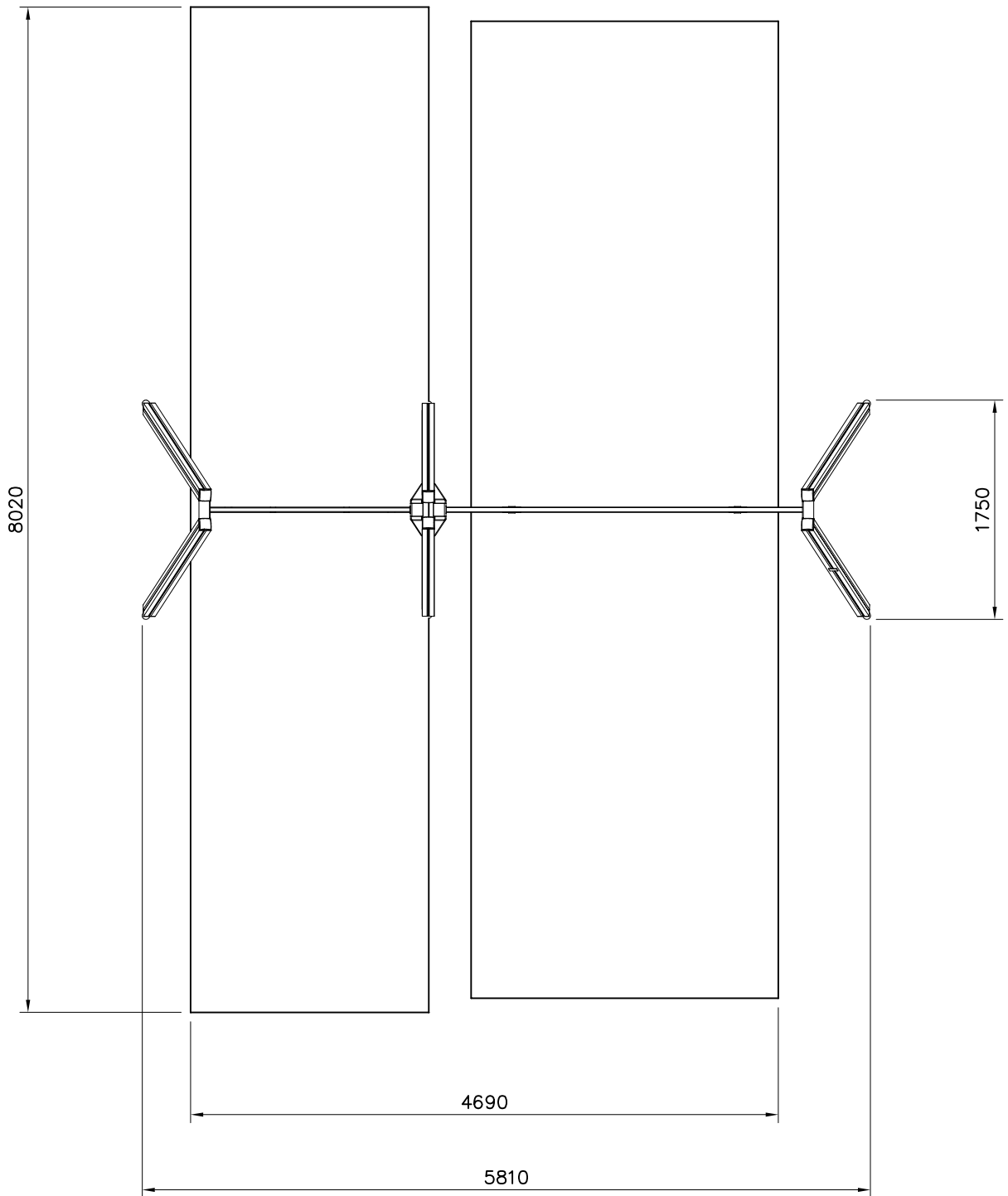
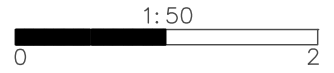

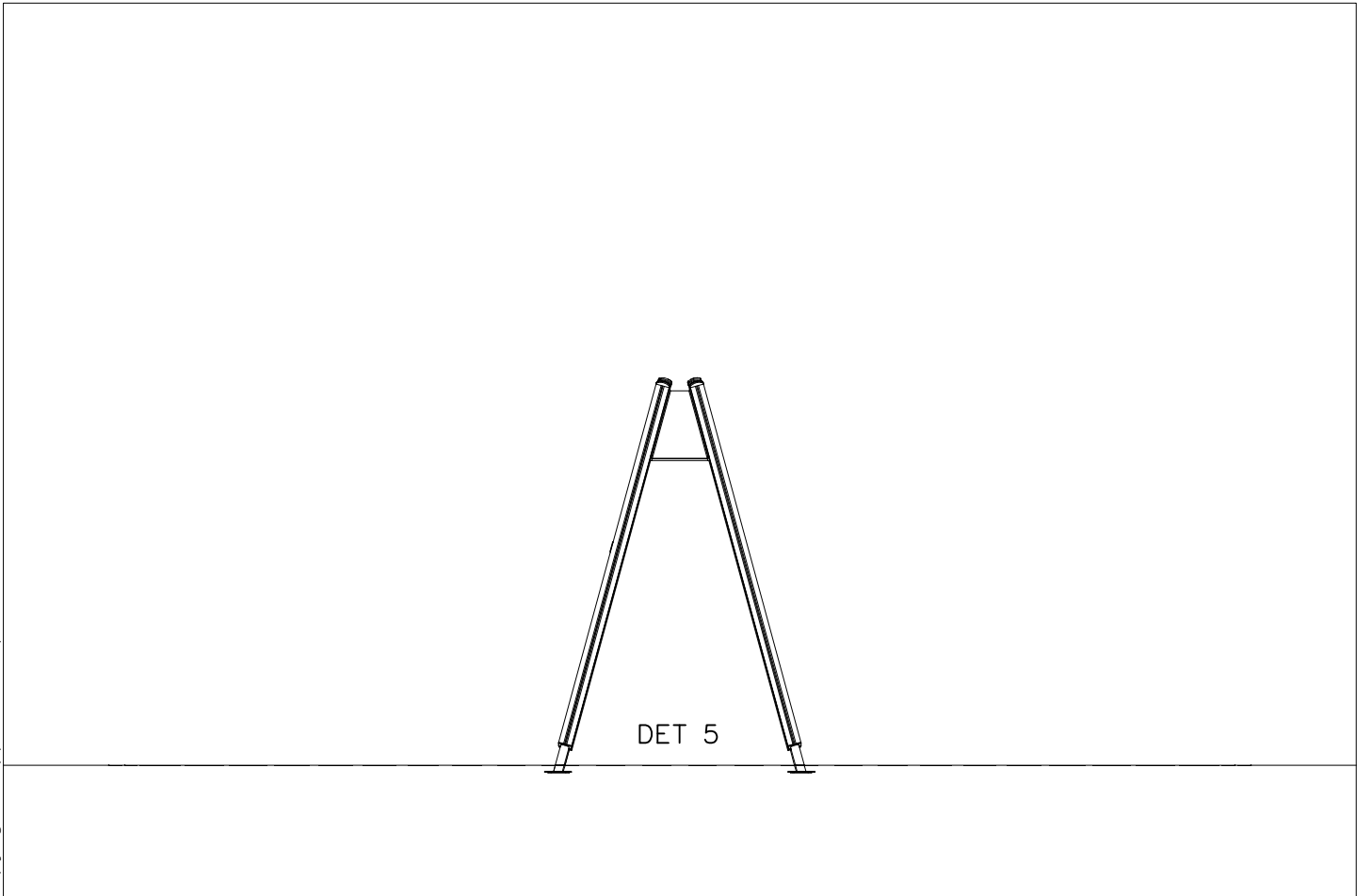
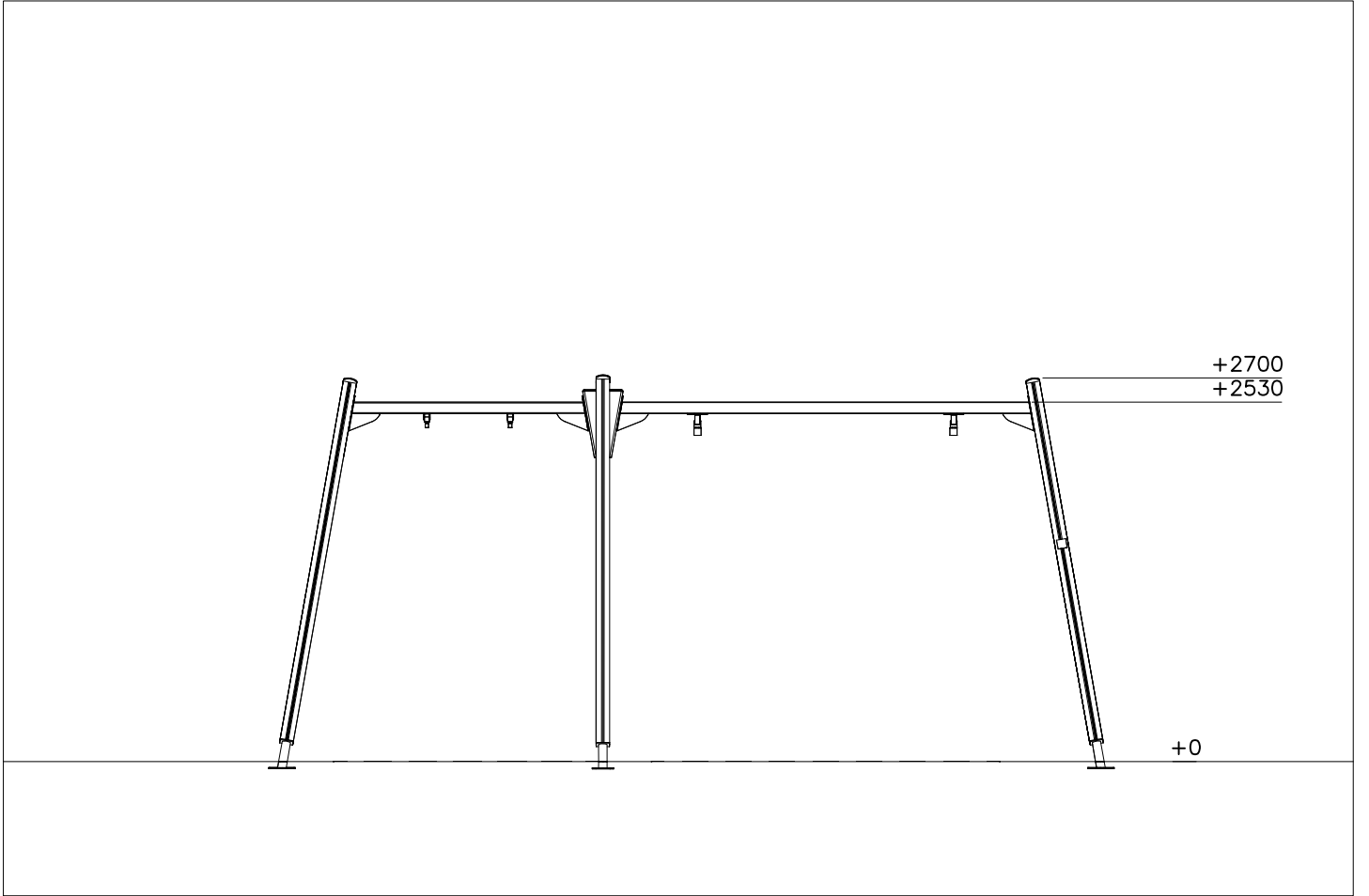

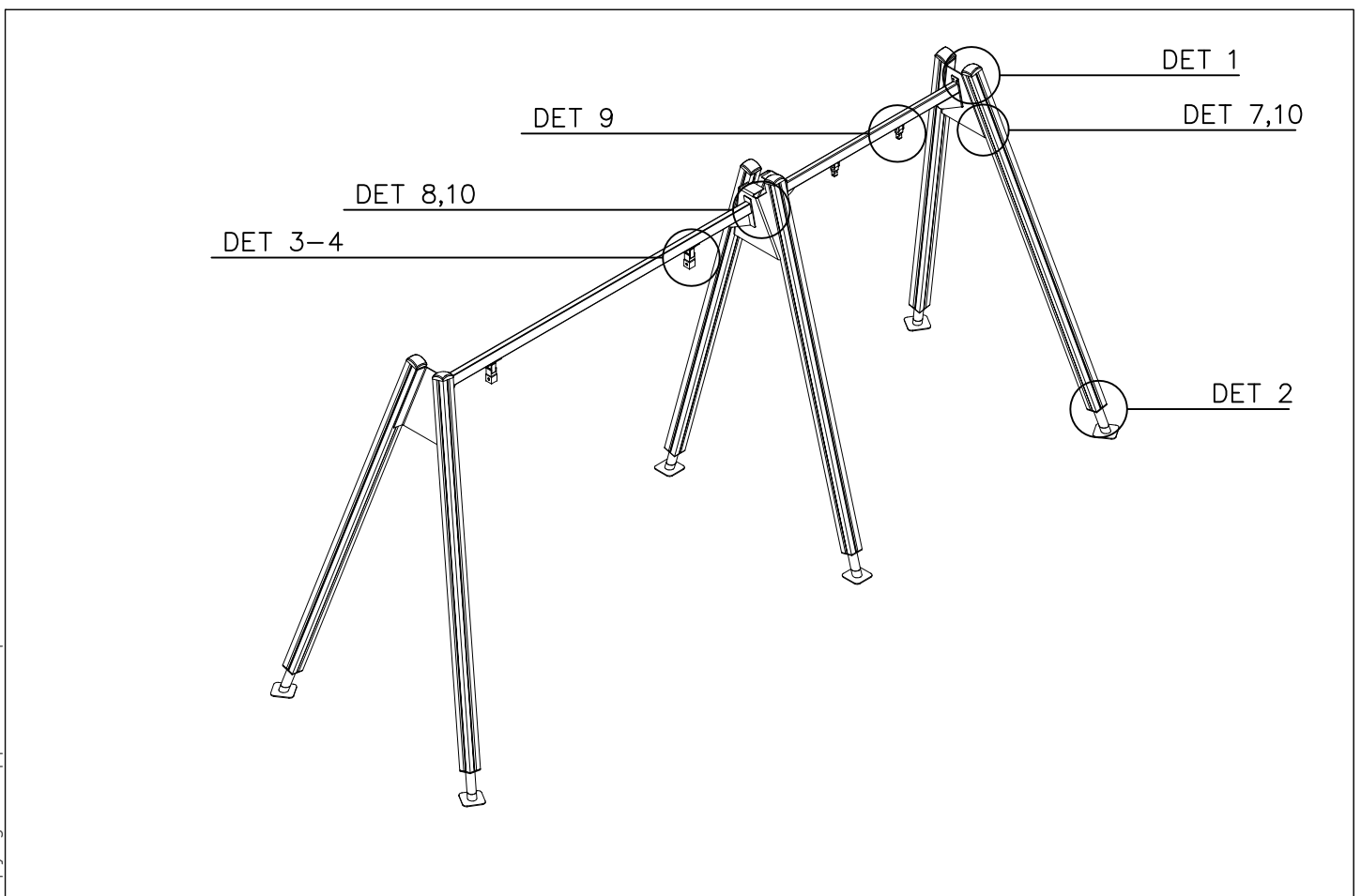
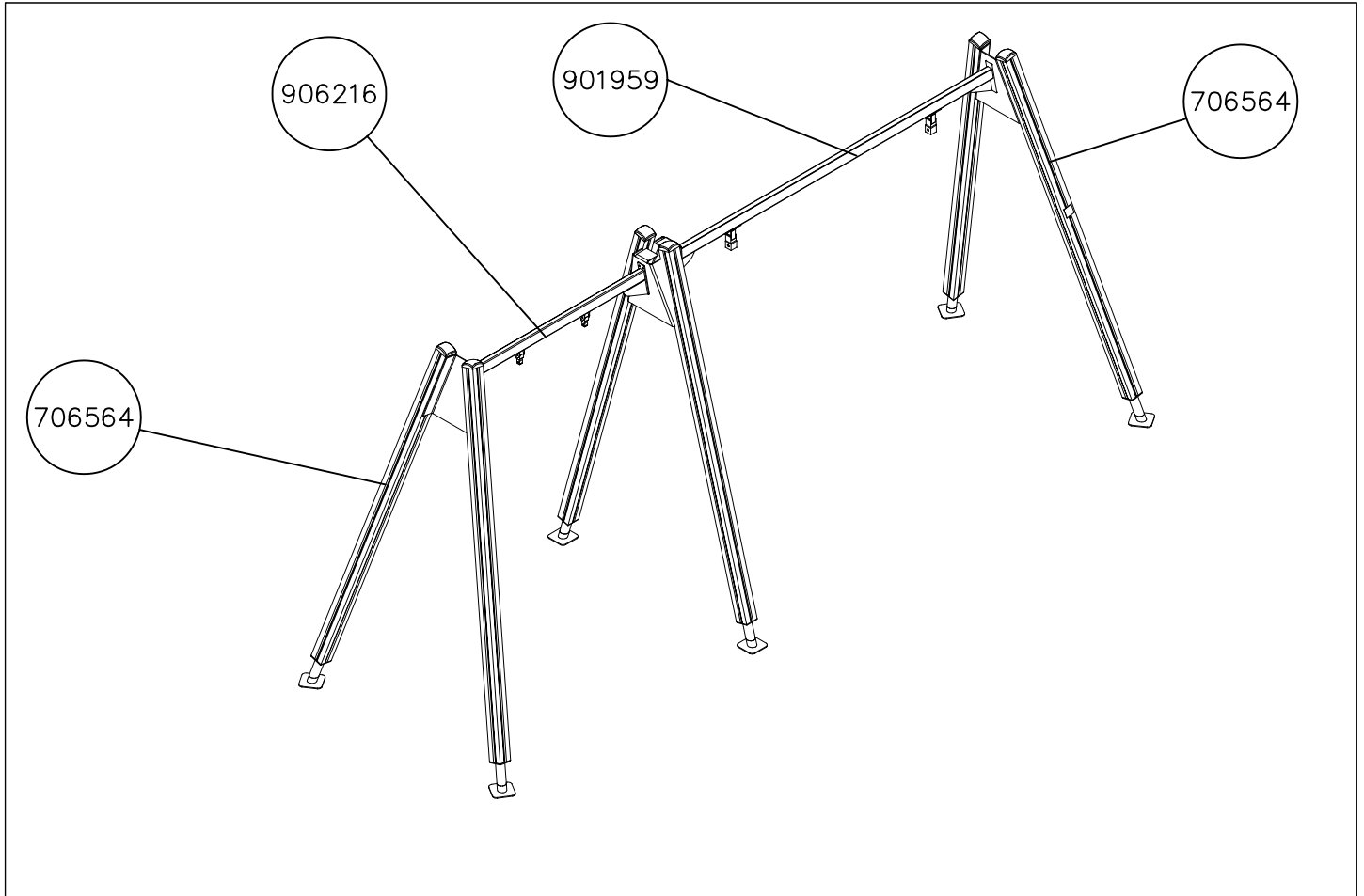

<p>DET 1</p> <p>6x60 980131</p>	<p>DET 2</p> <p>M10 905104 909521</p>	<p>DET 3</p> <p>901958 903577</p>	<p>DET 4</p> <p>M12x110 Ø24/13 901958 M8x35 M12 M8 CUT EXTRA CHAIN</p>
<p>DET 5</p> <p>&gt;400</p>	<p>DET 6</p>	<p>DET 7</p> <p>M12 -&gt; 80 Nm Ø24/13 M12x30 M12 M10x25 Ø20/10.5 M10 M10 -&gt; 45 Nm</p>	<p>DET 8</p> <p>904317</p>
<p>DET 9</p> <p>90Nm M12 980154 Ø24/13 904904</p>	<p>DET 10</p> <p>999561 GLUE Ø24/13 12x35 905115 905090</p>	<p>DET 2</p> <p>140 Nm M16x110 Ø30/17x3</p>	<p>DET 2</p> <p>140 Nm M16x110 Ø30/17x3</p>

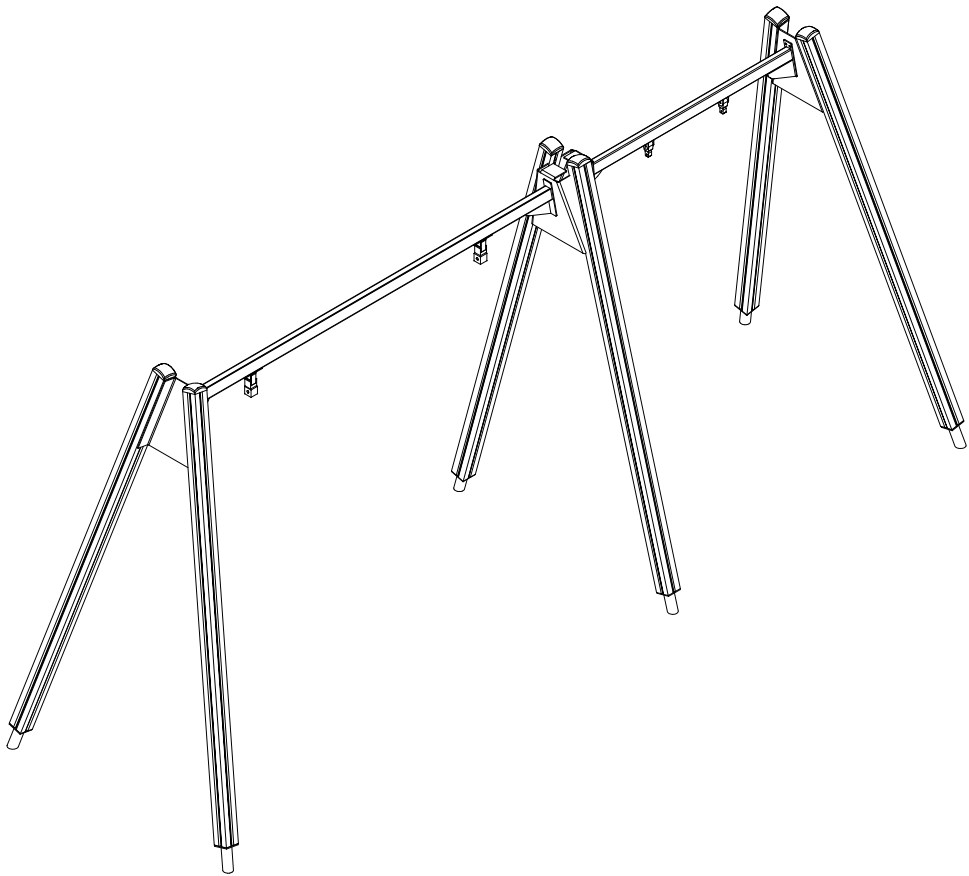
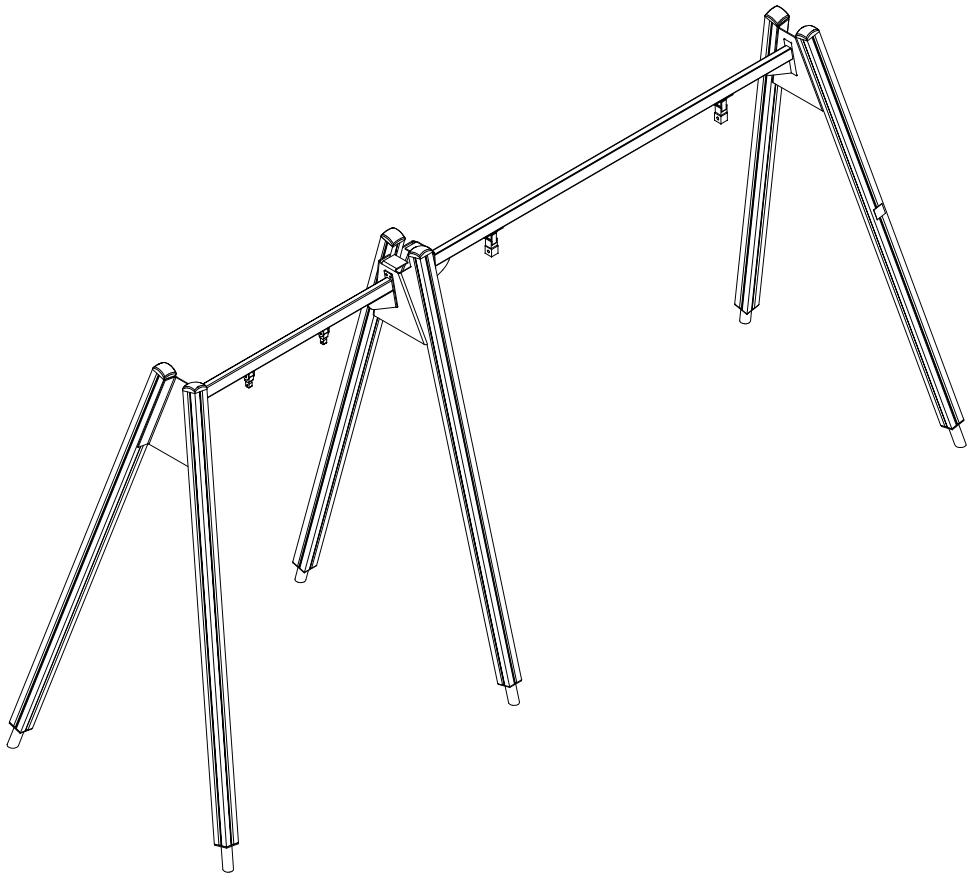



		
<p><b><math>h &lt; 600</math></b></p> <p>Without movement and therefore without Impact Area</p>	<p>Totally hard surfaces.</p> <p>Note. Lappset does <u>not recommend</u> totally hard surfaces at all.</p>	<p>E.g. concrete or asphalt</p> 
<p><b><math>h &lt; 600</math></b></p> <p>With movement e.g. rocking</p>	<p>Materials with very limited impact attenuating properties.</p>	<p>E.g. wood</p> 
<p><b><math>h &lt; 1000</math></b></p>	<p>Materials with significant impact attenuating properties.</p>	<p>fine gravel 0–8 mm</p>  <p>grass</p>  <p>unsorted sand</p> 
<p><b><math>h &lt; 3000</math></b></p>	<p>Loose fill material</p> <p>E.g. sand/gravel 0,25...8 mm D60/D10&lt;3,0 Woodchips 5...30 mm bark 20...80 mm</p>	 <p><math>\underline{S}</math>                      <math>\underline{h}</math></p> <p>30 cm                      &lt; 2,0 m</p> <p>40 cm                      &lt; 3,0 m</p>
	<p>Syntethic granulates</p> <p><math>\underline{S}</math>                      <math>\underline{h}</math></p> <p>40 mm ~&gt; 1,2...1,3 m</p> <p>50 mm ~&gt; 1,5...1,7 m</p> <p>60 mm ~&gt; 1,8...2,0 m</p> <p>70 mm ~&gt; 2,1...2,5 m</p> <p>Note. For accurate values, see manufacturer's instructions.</p>	

REMOVE SAFETY SURFACE/SAND/GRAVEL  
TO CHECK FOUNDATION



REMOVE SAFETY SURFACE/SAND/GRAVEL  
TO CHECK FOUNDATION



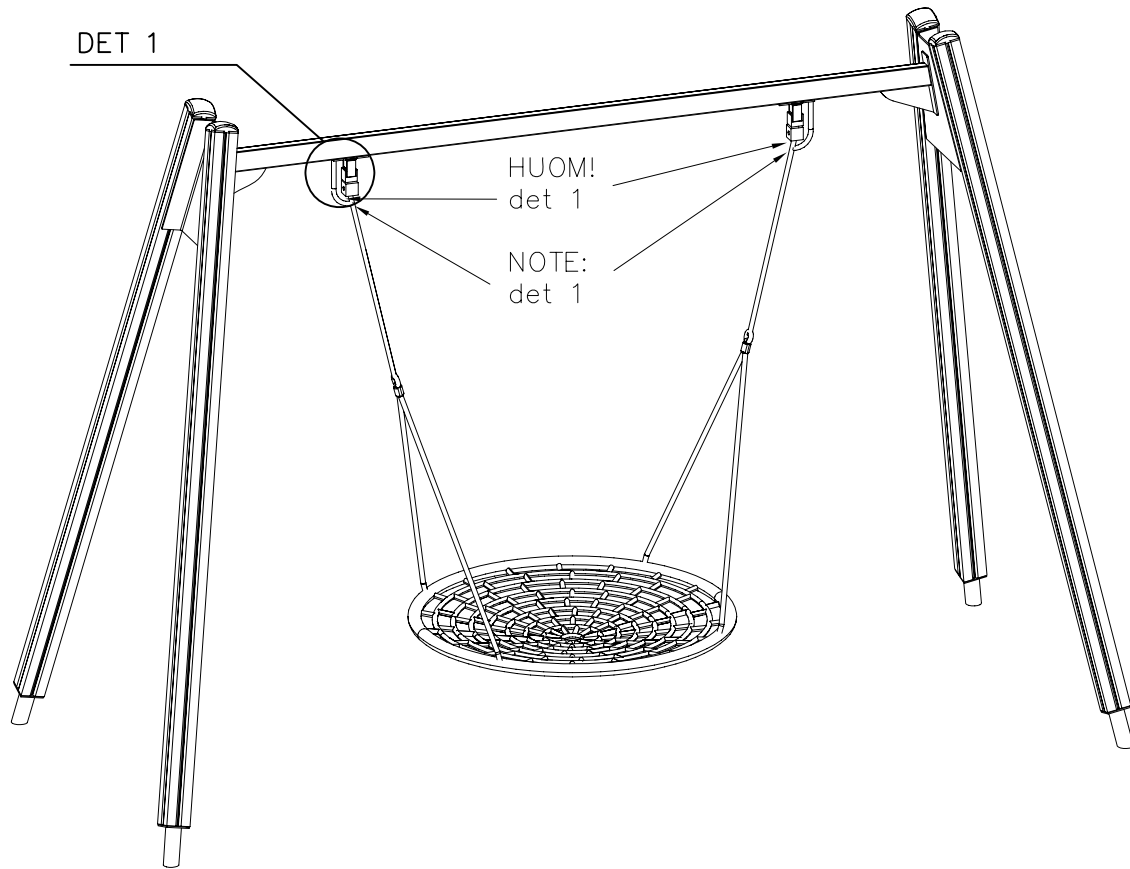

DET 1

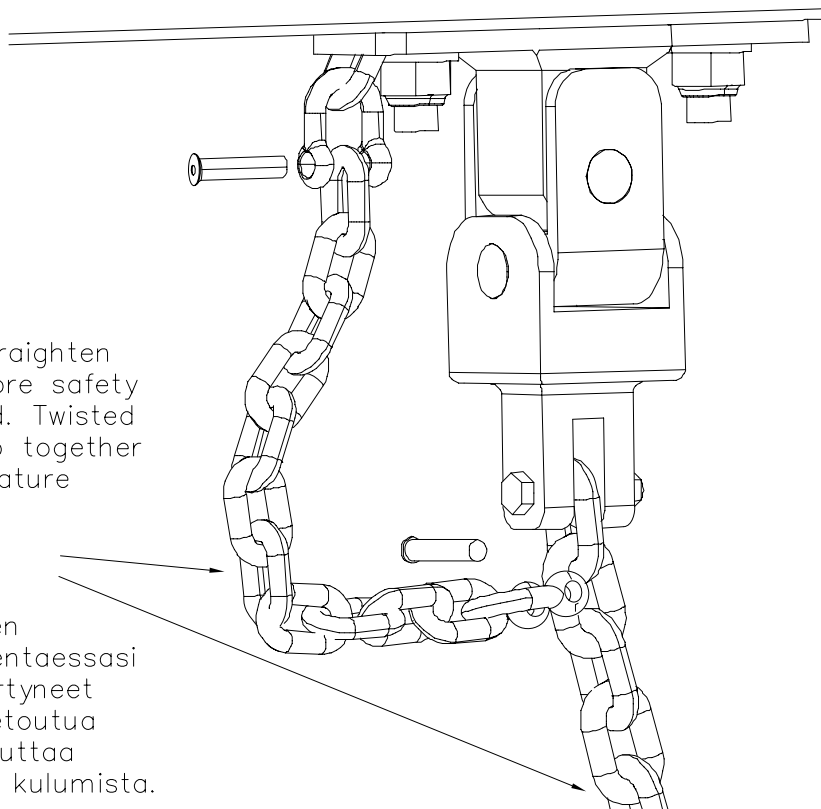

**LAPPSET®**  
**BETON FOUNDATION**

**FOOT**

DATE: 27.10.2015

**1(1)**

② 905104	PCS		PCS
	4		
 M10	PCS		PCS



905104



DET 1, 2, 3

① 909531	PCS	① 909513	PCS
	1		1
		60°	
① 909514	PCS	① 902056	PCS
	1		1
		75°	57°
① 902062	PCS		PCS
	1		
		70°	
	PCS		PCS
	PCS		PCS
② 909628	PCS		PCS
	4		
M10x100			

DET 1

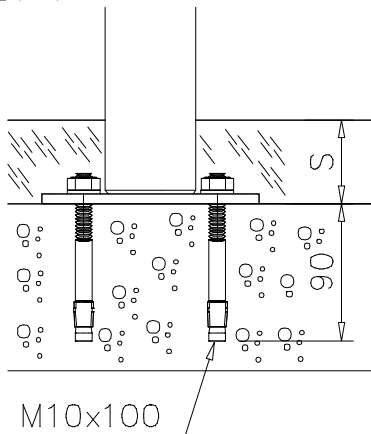

DET 2

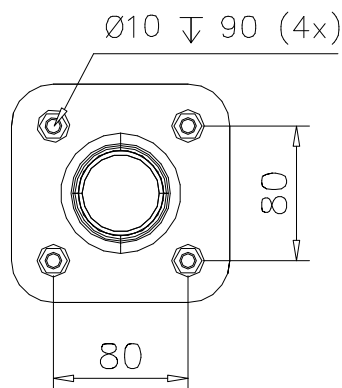

DET 3

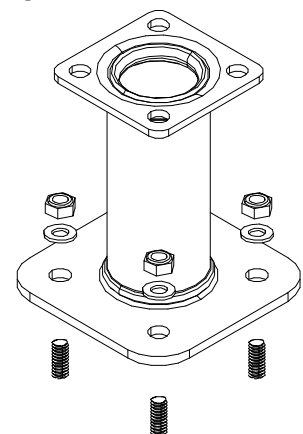

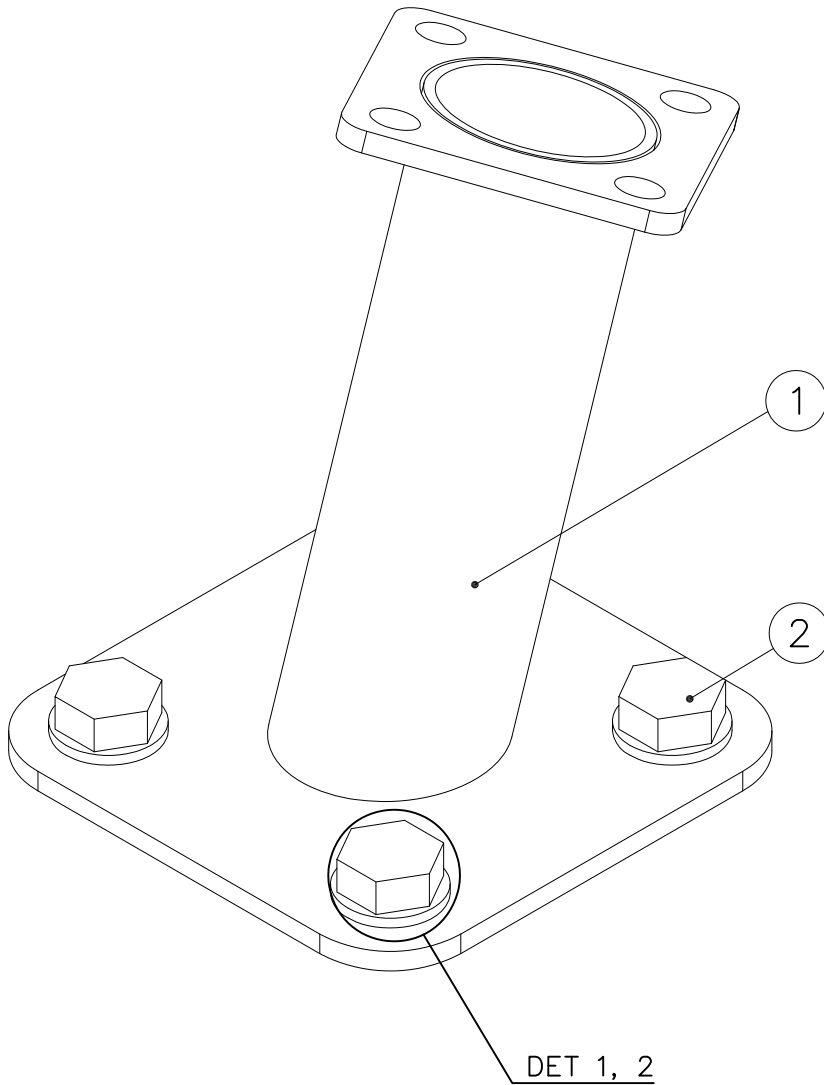

① 929550	PCS	① 929551	PCS
	1		1
RIGHT		LEFT	
	PCS		PCS
	PCS		PCS
	PCS		PCS
② 909520	PCS	③ 929426	PCS
	4		4
Ø30/17		M16x100	
④ 929914	PCS		PCS
	4		
M16x110			

DET 1

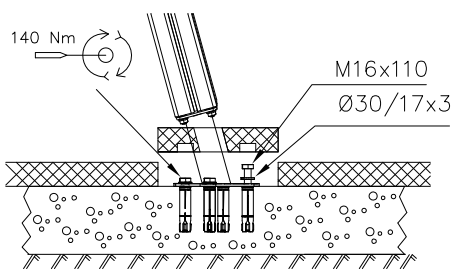

DET 2

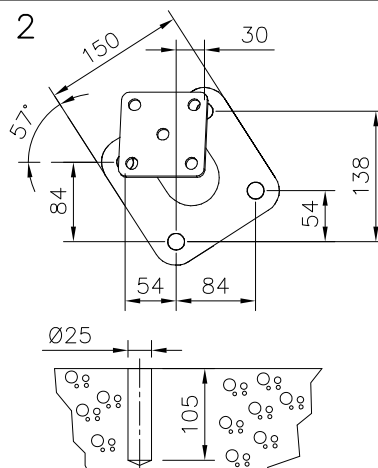

DET 3



## Tuotekyltti tulee tuotteen mukana yhdellä seuraavista tavoista:

### 1) Metallinen tuotekyltti ja kiinnitysruuvit

- Kiinnitä tuotekyltti ruuveilla tolppaan noin 2 metrin korkeuteen kuvan 1 mukaisesti.

### 2) Tuotekylttitarra

- Puhdista maalattu metalli- tai vaneripinta pölystä ja kosteudesta. Liimaa tarra kuvan 2 mukaisesti.
- Huom. Älä kiinnitä tarraa karheapintaiseen laminaattiin tai maalattuun puuhun.

## Vår produktmärkning levereras på ett av följande sätt:

### 1) Produktskylt i metall

- Fäst skylten med de medföljande skruvarna

### 2) Självhäftande produktetikett

- Rengör den pulverlackerade metallytan eller laminatyten så att den blir fri från smuts och fukt. Fäst etiketten enligt fig. 2.
- Obs! Fäst ej etiketten på detaljer med skrovlig yta eller på målat trä.

## Product label is delivered by one of following ways:

### 1) Metal product label and screws

- Fasten the label with screws.

### 2) Label sticker

- Clean the painted metal or plywood surface from dirt and moisture. Fasten the sticker as shown in the figure 2.
- Note. Do not attach the sticker to rough surfaced laminate or painted wood.

## La plaque d'informations produit est livrée sous l'une de ces 3 formes :

### 1) Plaque métallique et vis

- Fixez la plaque à l'aide des vis.

### 2) Etiquette autocollante

- Avant de coller l'étiquette, nettoyez le composant métallique peint ou la plaque de contreplaqué, de toute saleté. La surface doit être sèche (voir image 2).
- Attention, ne pas coller l'étiquette sur une surface lamellé-collée irrégulière ou sur du bois peint.

## Die Auslieferung des Produktaufklebers erfolgt auf eine dieser Arten:

### 1) Produkt-Schild aus Metall incl. Schrauben

- Die Befestigung des Schildes erfolgt mittels der Schrauben.

### 2) Aufkleber

- Entfernen Sie zunächst Schmutz und Feuchtigkeit vom lackierten Metall bzw. von der Holzoberfläche und bringen Sie den Aufkleber wie im Bild oben rechts beschrieben auf den gesäuberten Untergrund auf.
- Beachten Sie: Bringen Sie den Aufkleber nicht auf raues laminiertes oder lackiertes Holz an.