

LAPPSET®

FITNESS







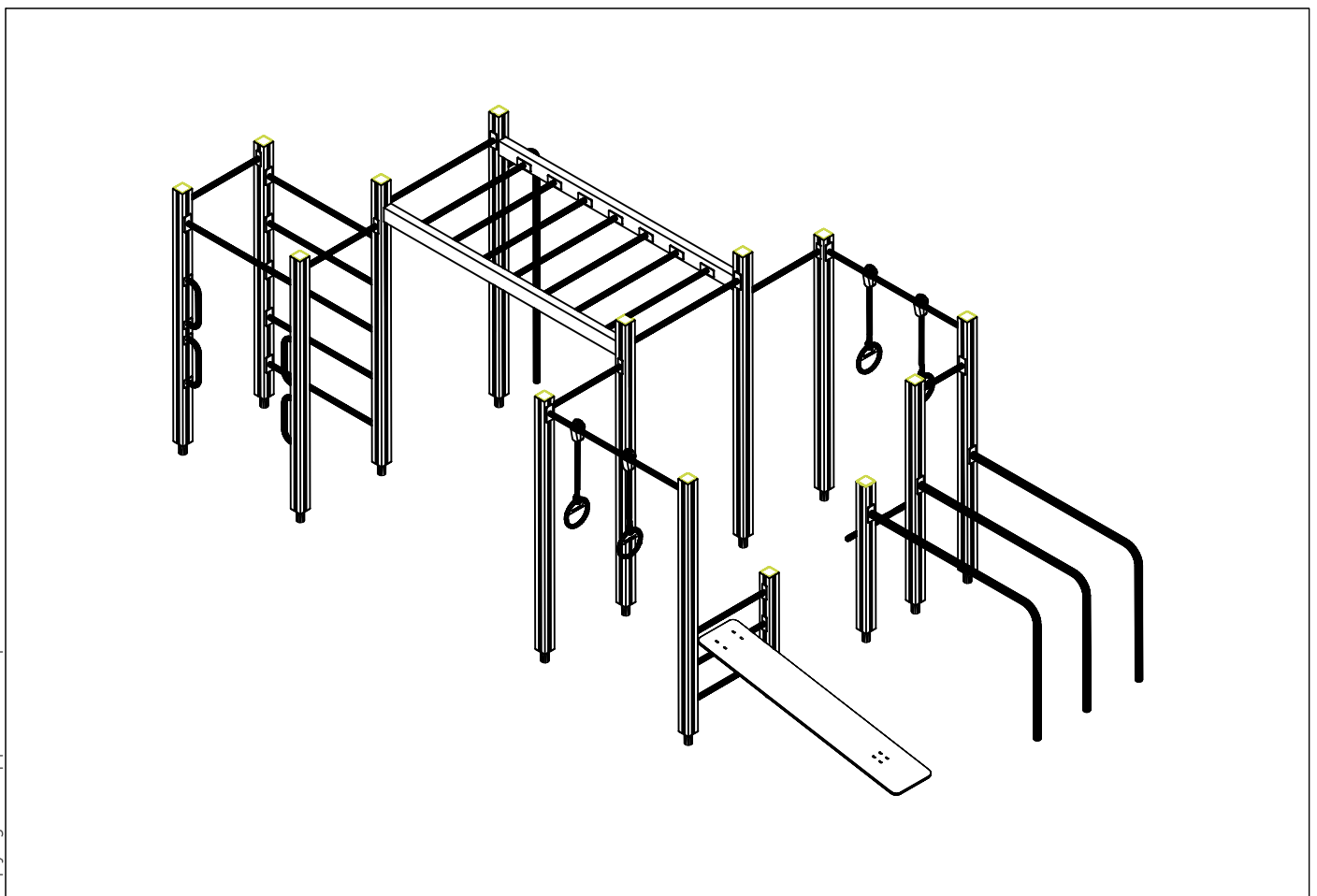





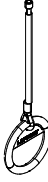
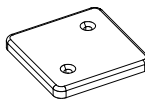

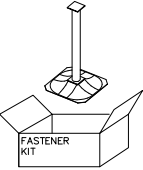



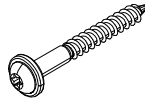
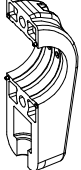
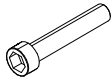

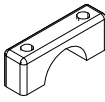
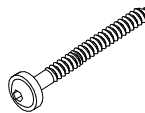

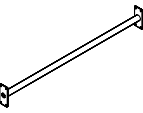
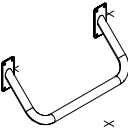
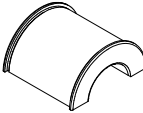
ASENNUSOHJE
MONTERINGSANSVISNING
INSTALLATION INSTRUCTION
AUFBAUANLEITUNG
NOTICE D'INSTALLATION

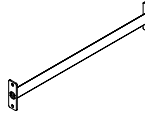
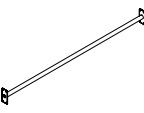
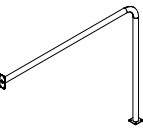
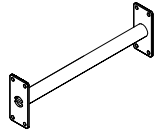
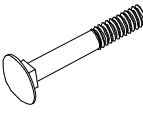
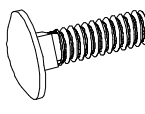
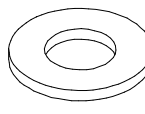
DATE: 21.10.2020

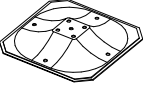
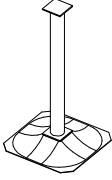
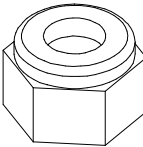
Q14764

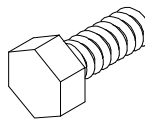
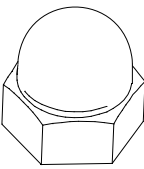
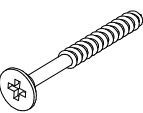
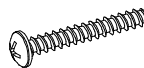

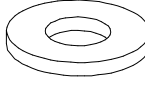
DATE: 17.11.2020

701401-602	Pcs	702286	Pcs	705040	Pcs	706481-703	Pcs	706484-602	Pcs	706511-602	Pcs
	1		1		4		14		7		1
L 1250		65x65		Ø16x764		83x83x10		93x93x2150		93x93x1870	
706531	Pcs	706669-602	Pcs	706894-602	Pcs	707294-602	Pcs	900240	Pcs	902195	Pcs
	14		4		1		2		28		8
		93x93x2400		L 950		70x120x2304		Ø8x70		150x50x50	
902232	Pcs	902233	Pcs	902272	Pcs	902454	Pcs	903093	Pcs	905817-217	Pcs
	4		4		3		2		24		1
M10x55		M10x30		90x90x450				Ø8x90		2626x386x60	
905838-217	Pcs	905934-217	Pcs	906006	Pcs	906635-217	Pcs	907694-217	Pcs	908017-217	Pcs
	15		1		8		4		7		2
L 1060				Ø64/36,4x59				L 704		L 1315	
908019-217	Pcs	908062-217	Pcs	909107	Pcs	909109	Pcs	909256	Pcs	909511	Pcs
	3		1		4		4		176		14
1500x1200		L 420		M12x80		M12x40		Ø16/8.4		90x90x650	
909519	Pcs	909521	Pcs	909637	Pcs	909638	Pcs	909639	Pcs	909644	Pcs
	14		1		12		24		12		8
50x380x380				M10		Ø20/10.5		M10x25		M12	
980107	Pcs	980114	Pcs	980123	Pcs	980154	Pcs	980161	Pcs	P01987	Pcs
	28		4		164		32		8		1
Ø6x60		Ø4x20		Ø7x60		Ø24/13		M10		2000x380	

— EN/AS Impact Area 57 m²
 - - - Falling Space 57.7 m²
 Grid size = 1000mm

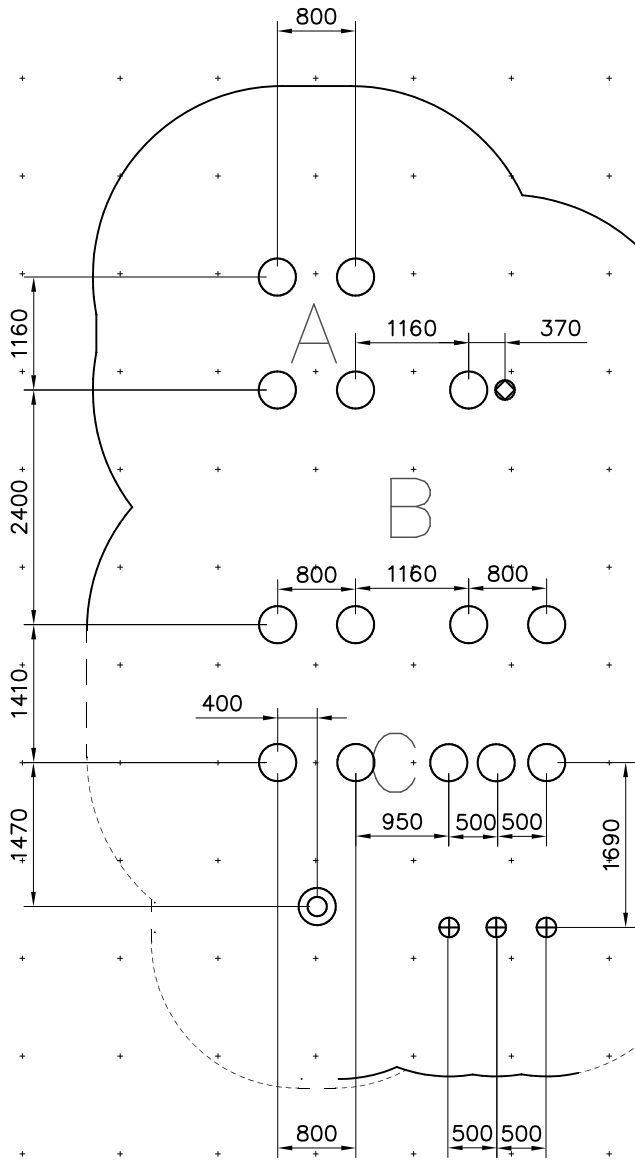
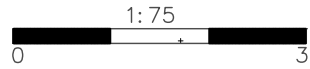

- EN/AS Impact Area 57 m²
- - - - Falling Space 57.7 m²
Max Falling Height 2300 mm

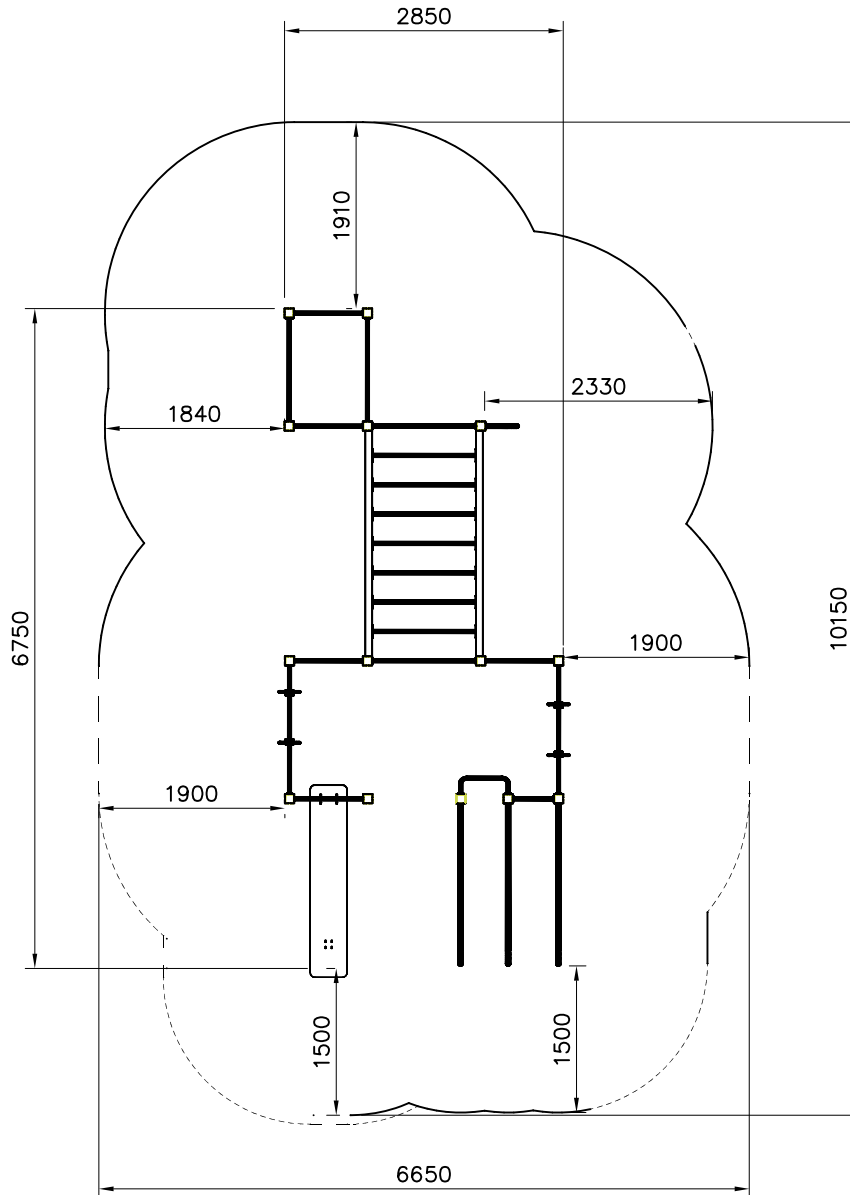
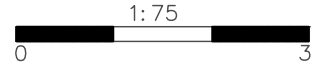

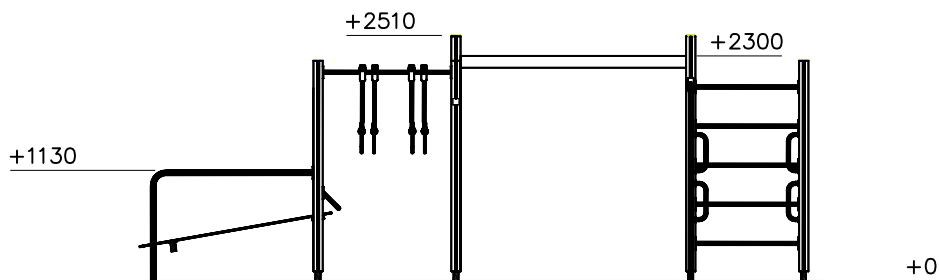
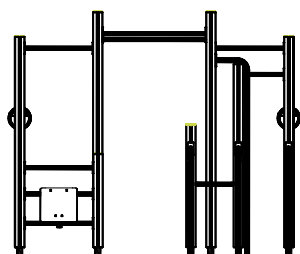

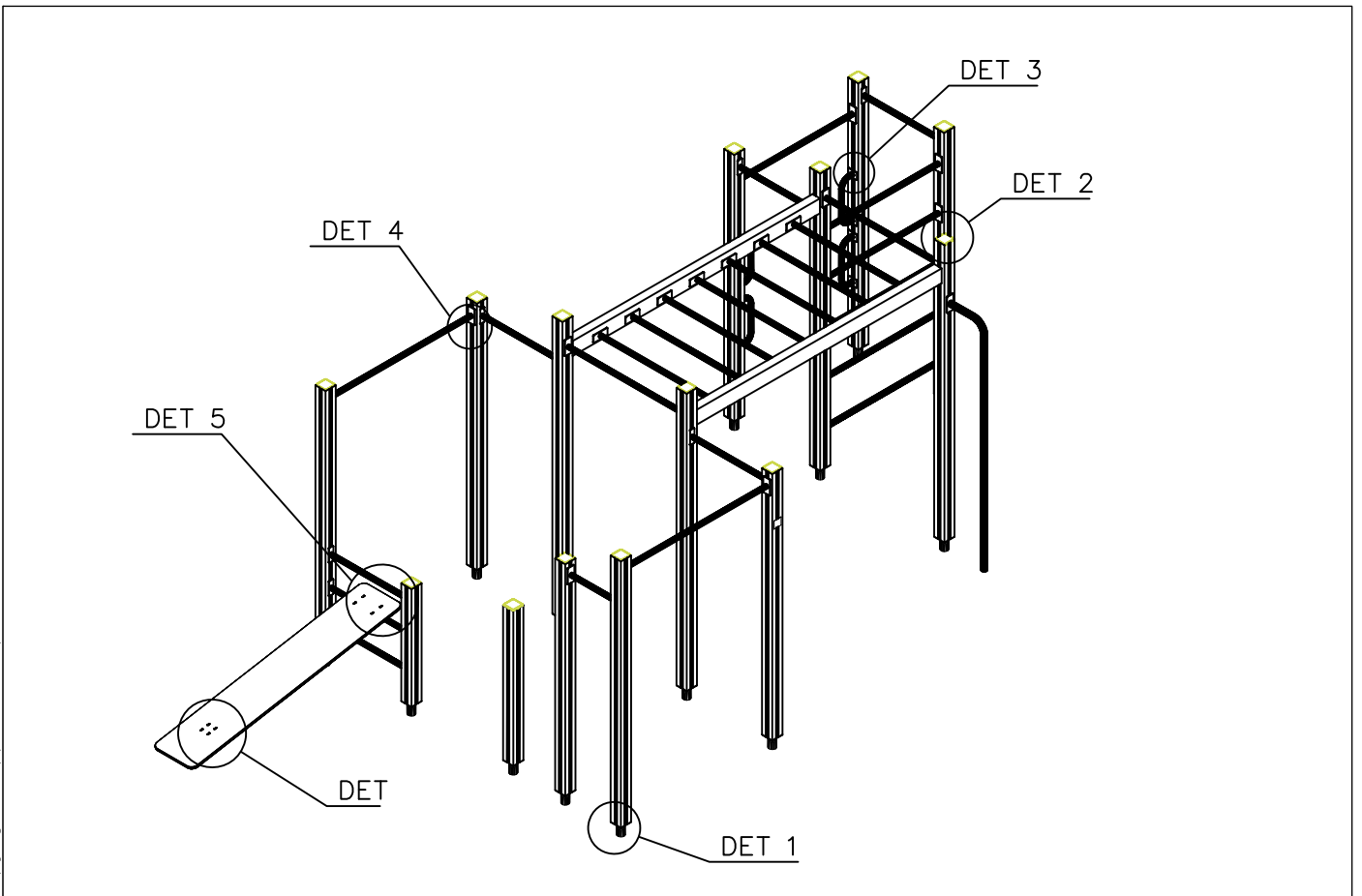
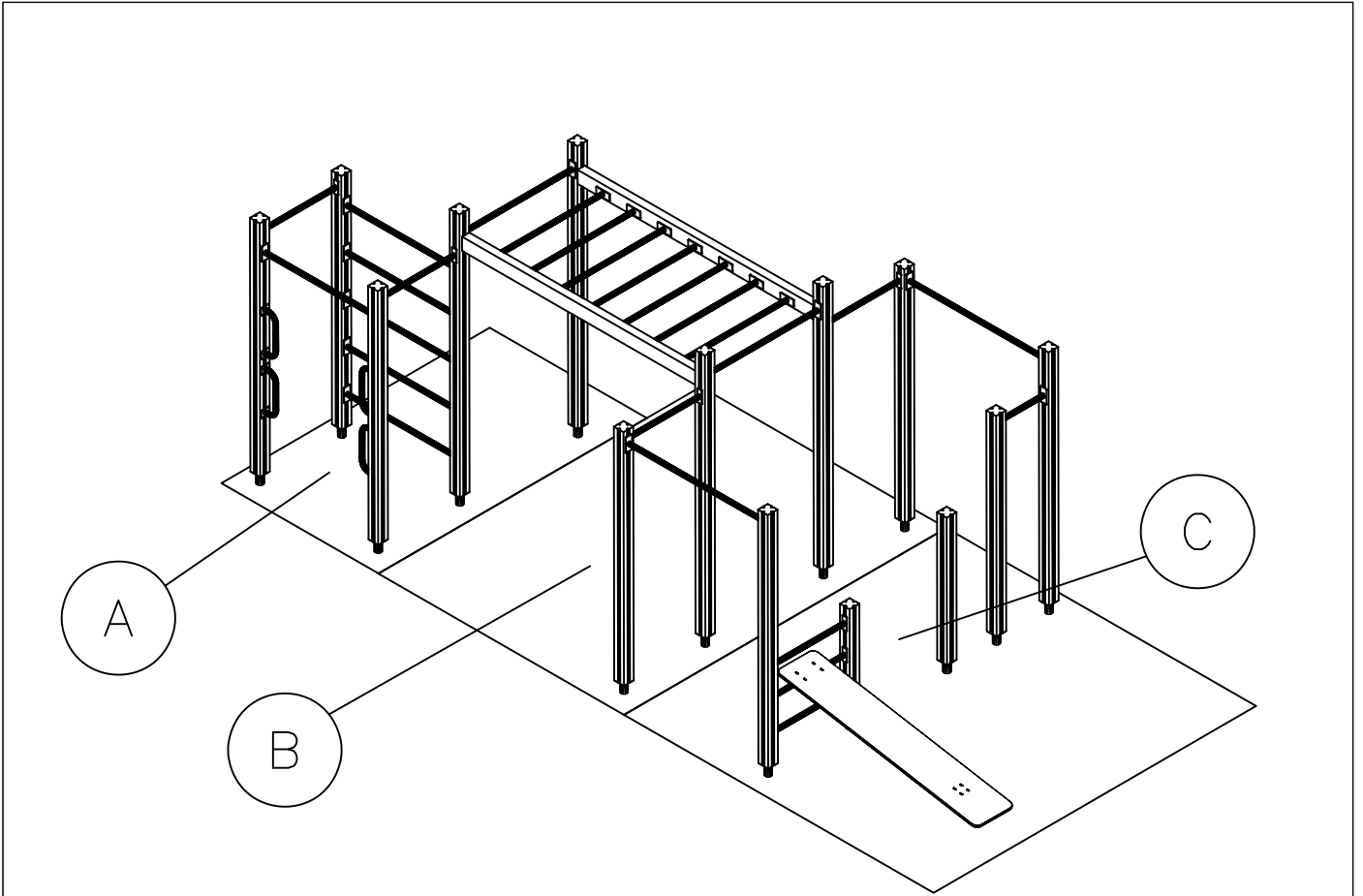

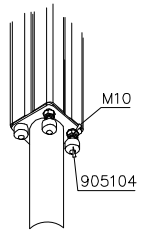
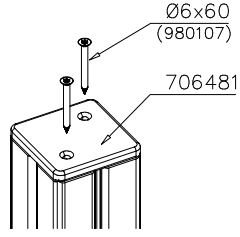
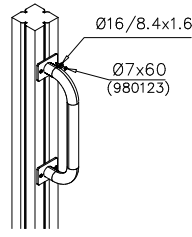
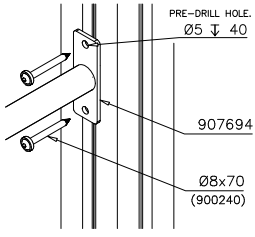
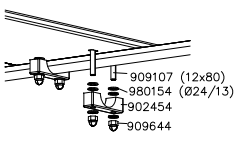
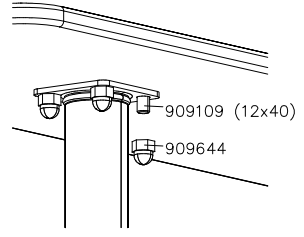
<p>DET 1</p> 	<p>DET 2</p> 	<p>DET 3</p> 	<p>DET 4</p> 
<p>DET 5</p> 	<p>DET 6</p> 		

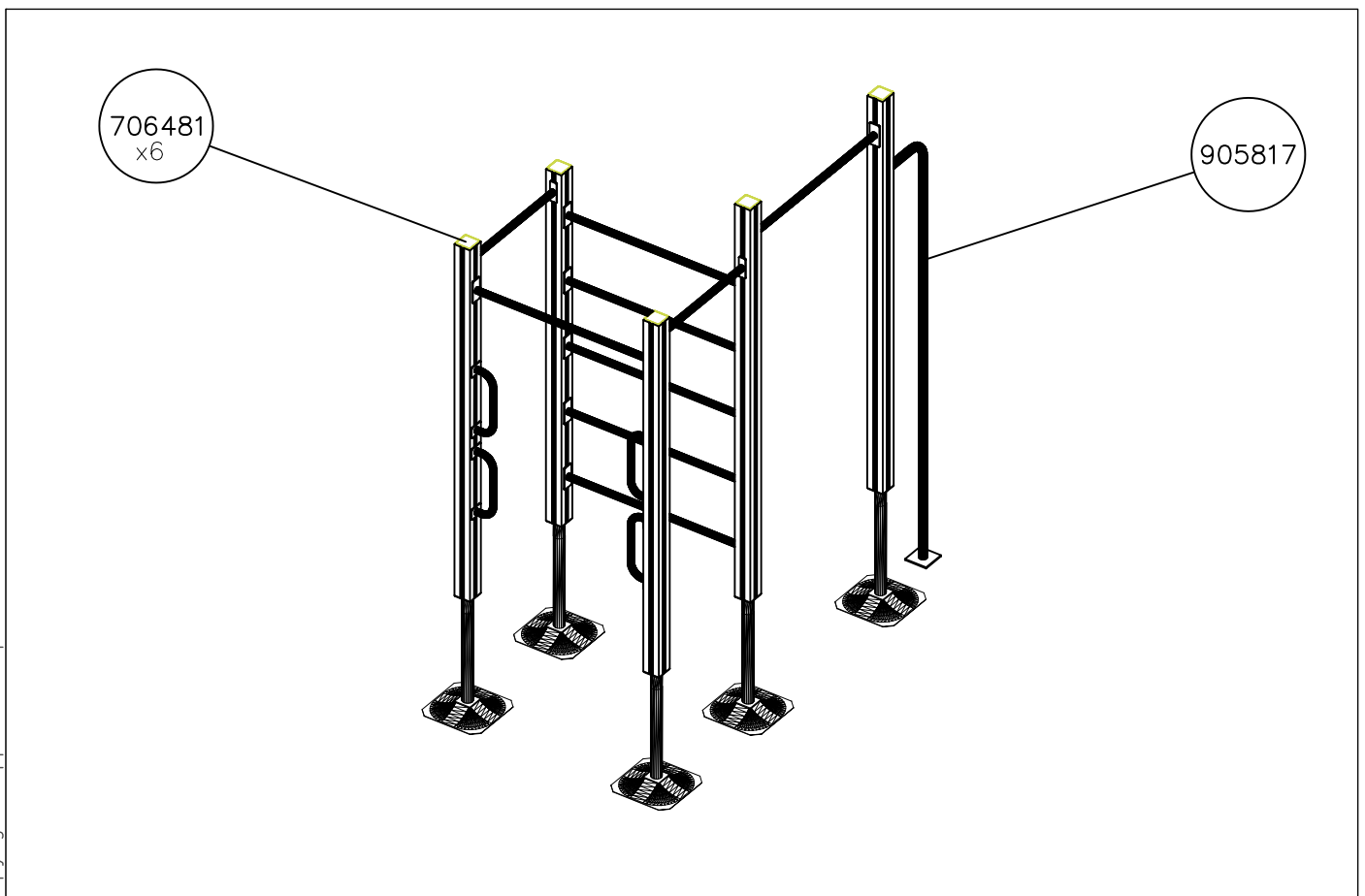
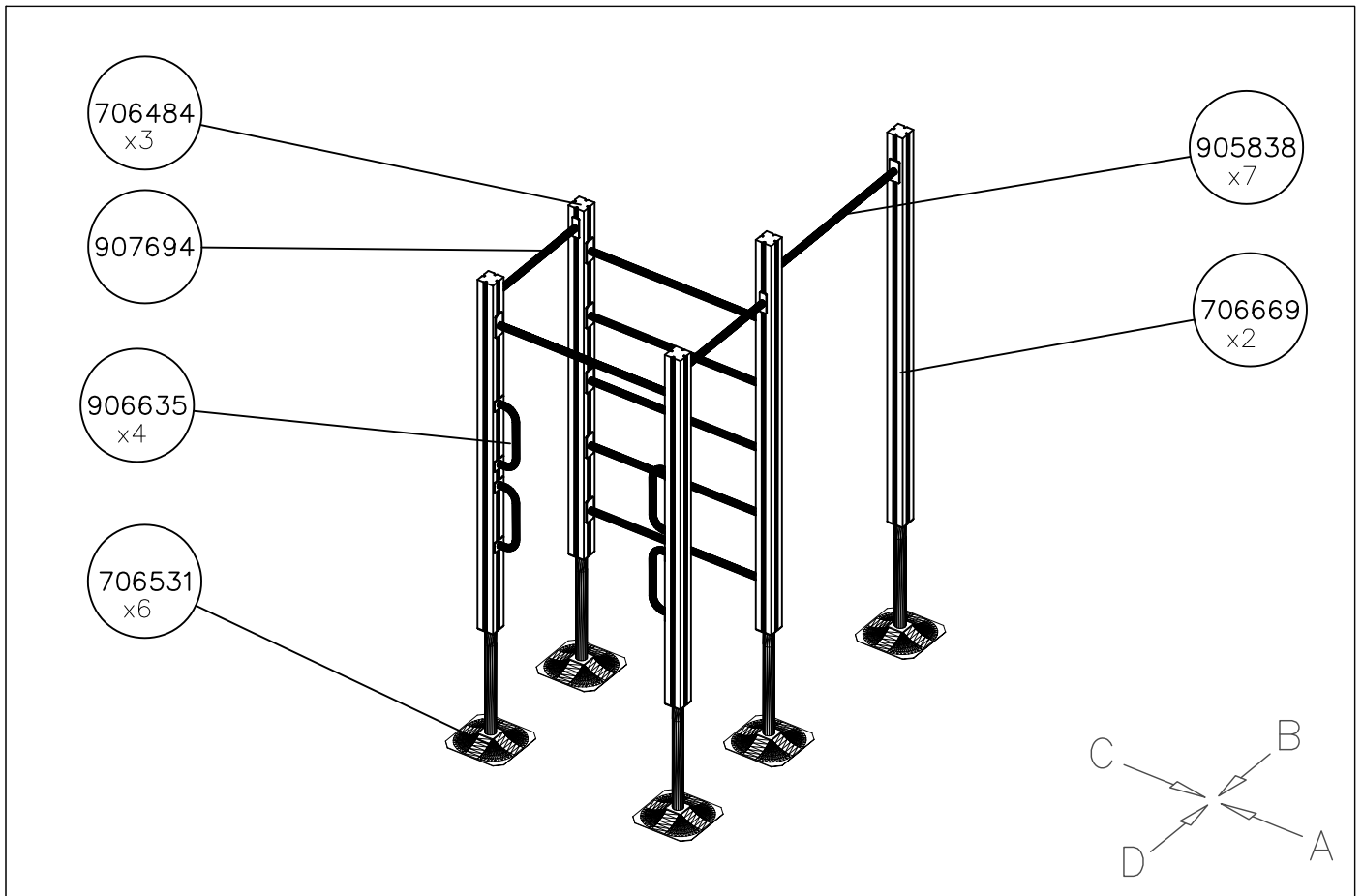

DATE: 21.10.2020

1:50

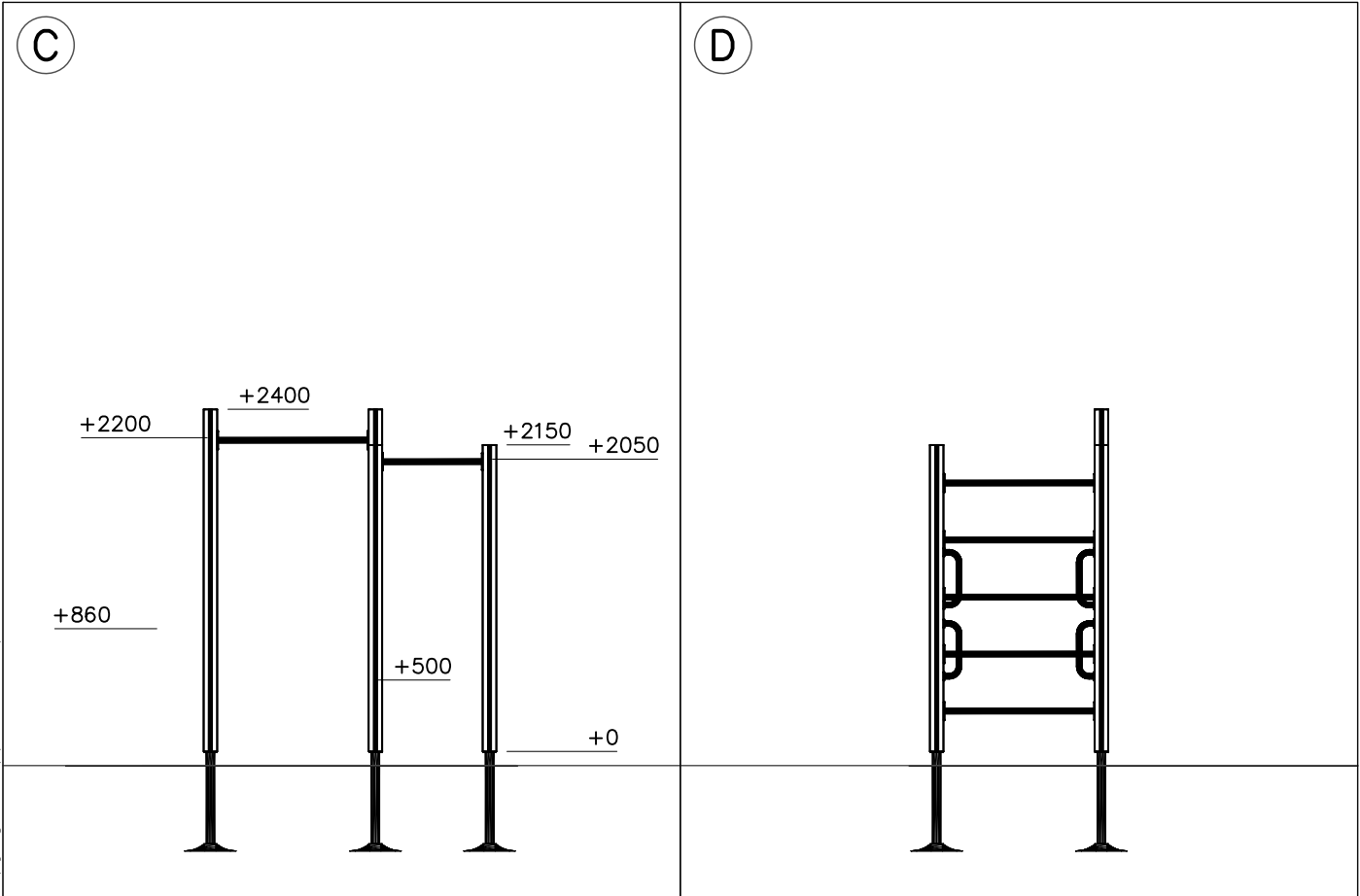
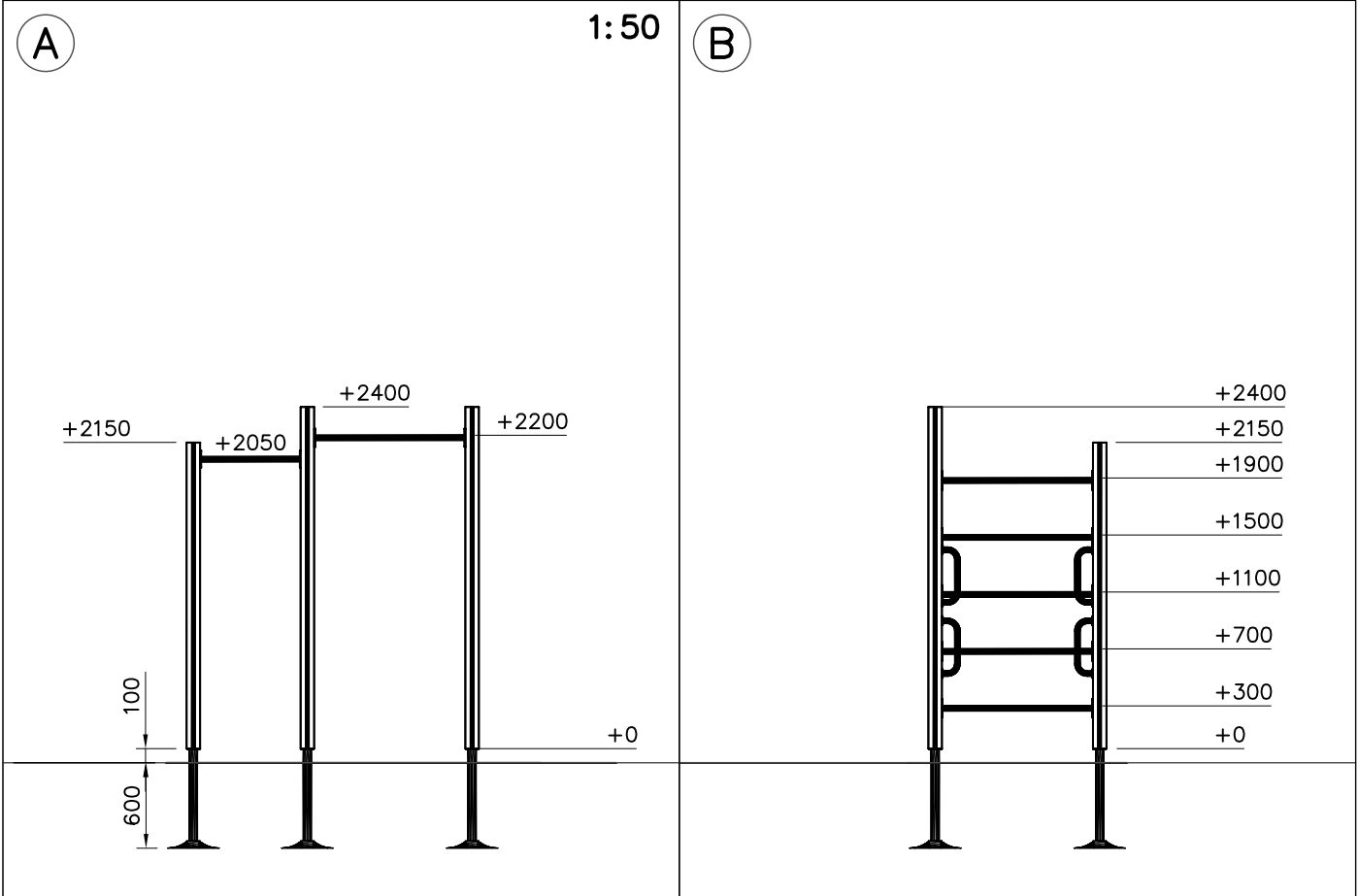

DATE: 21.10.2020

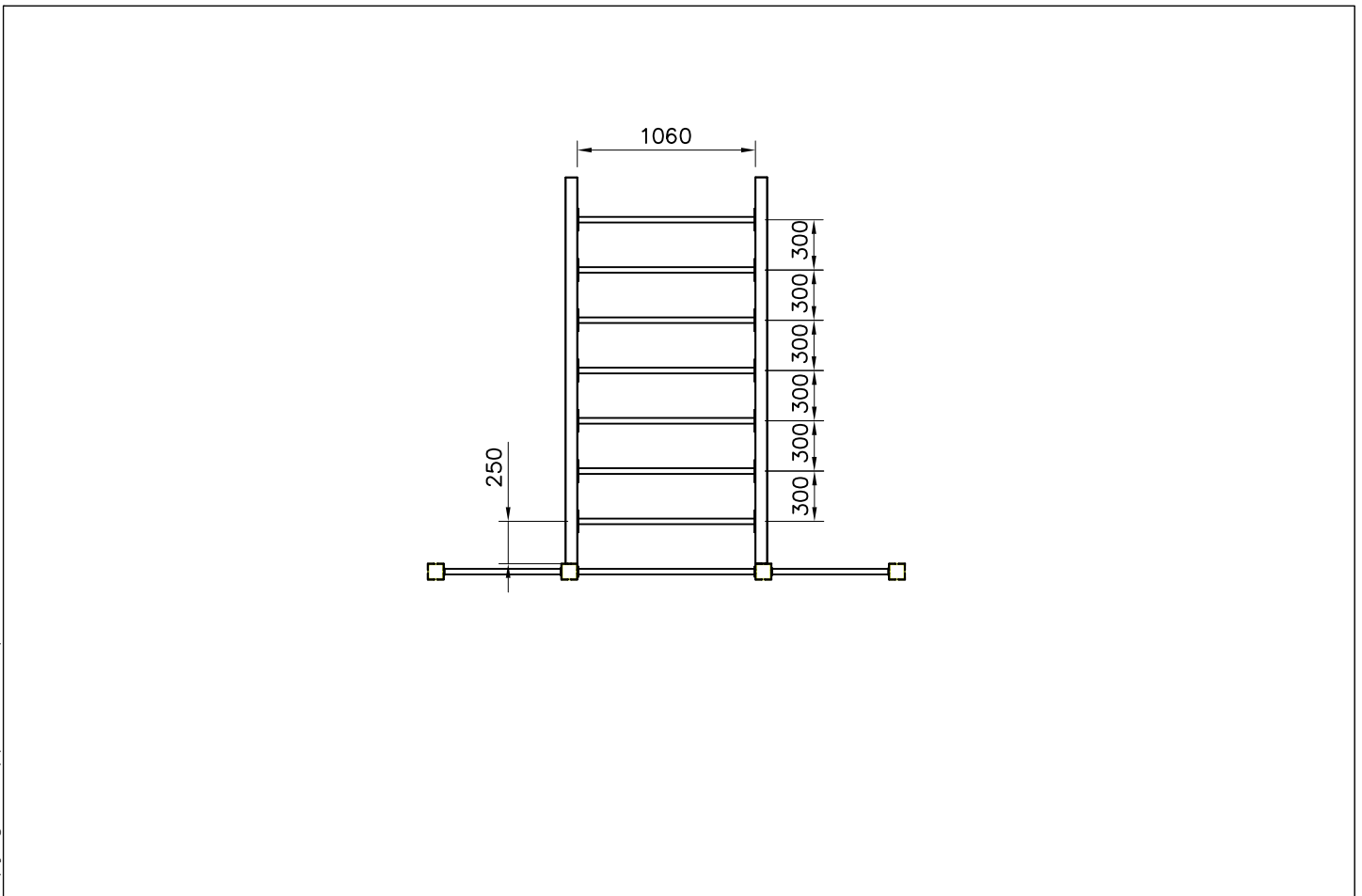
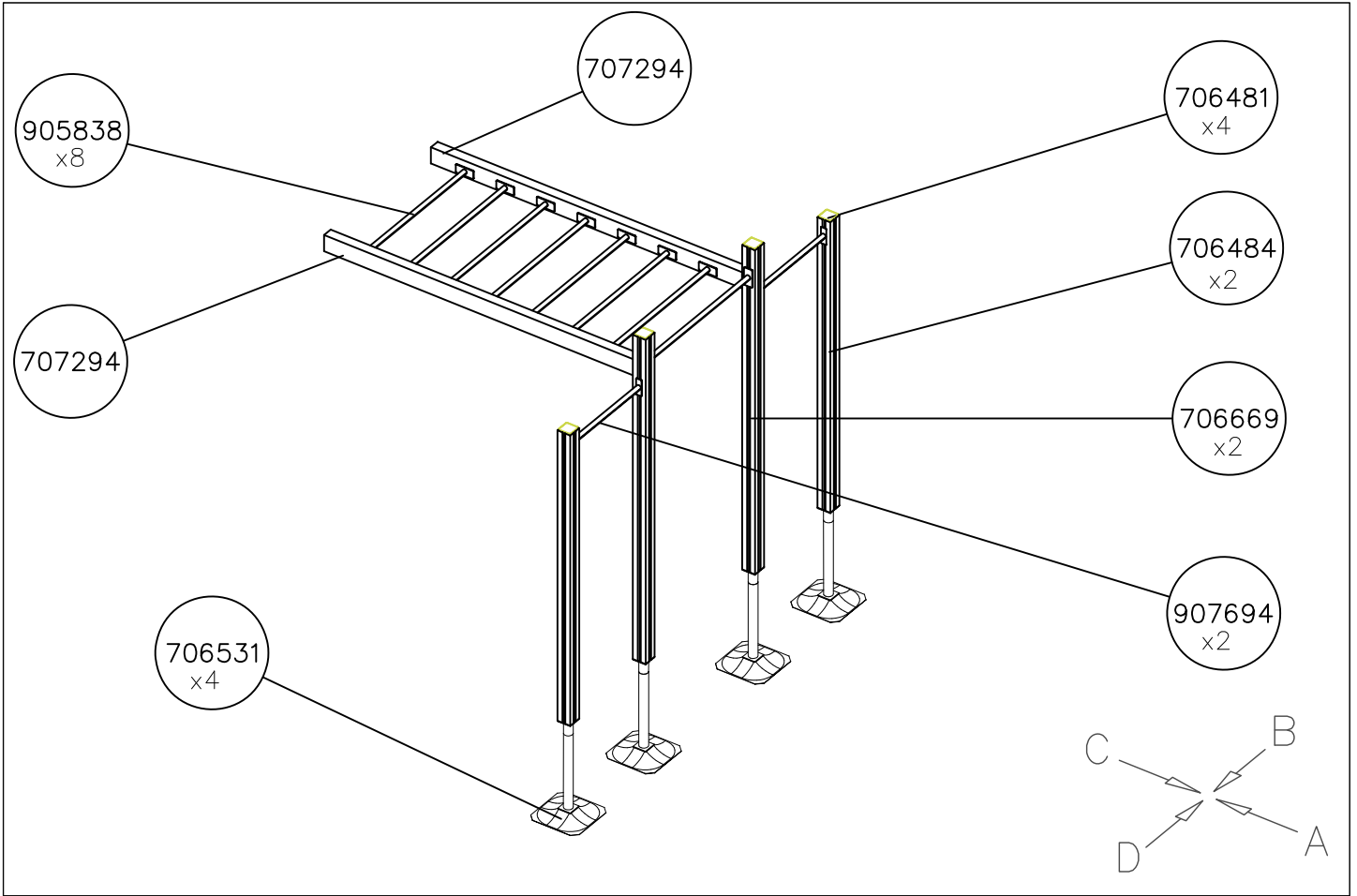

DATE: 21.10.2020

1:50

A

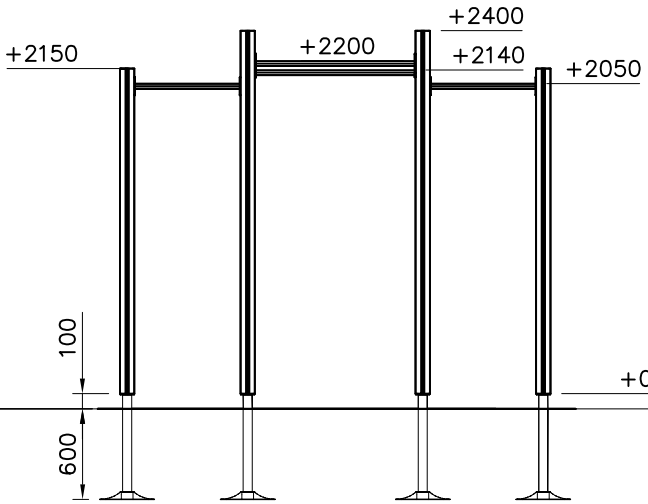

B

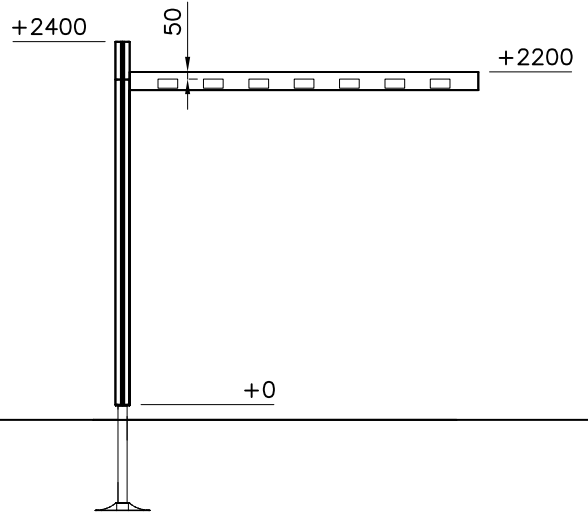

C

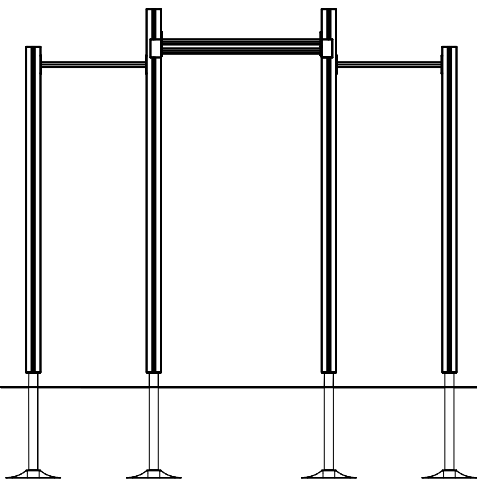

D

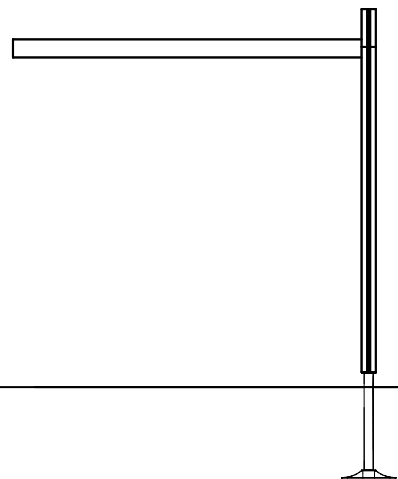

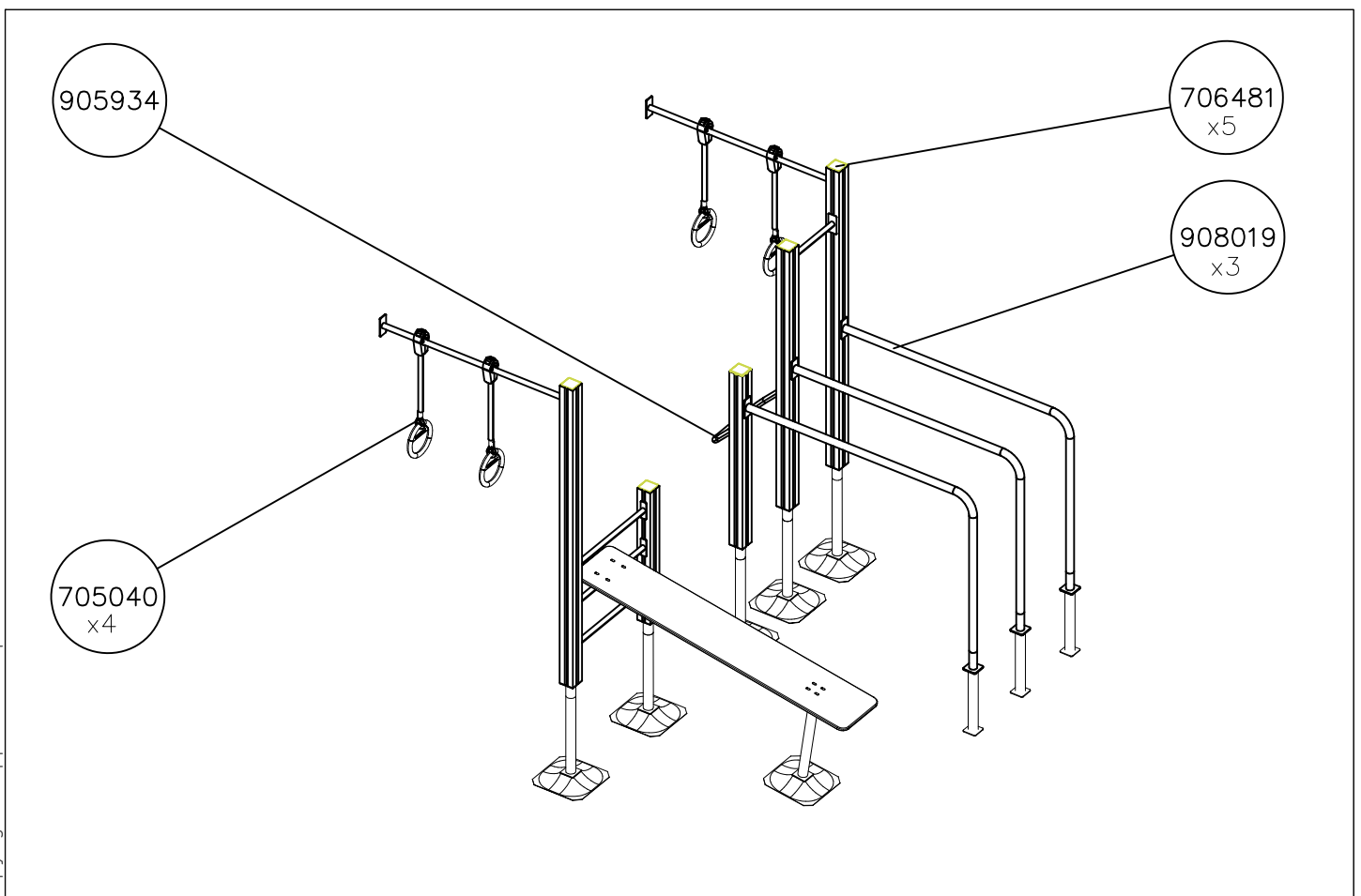
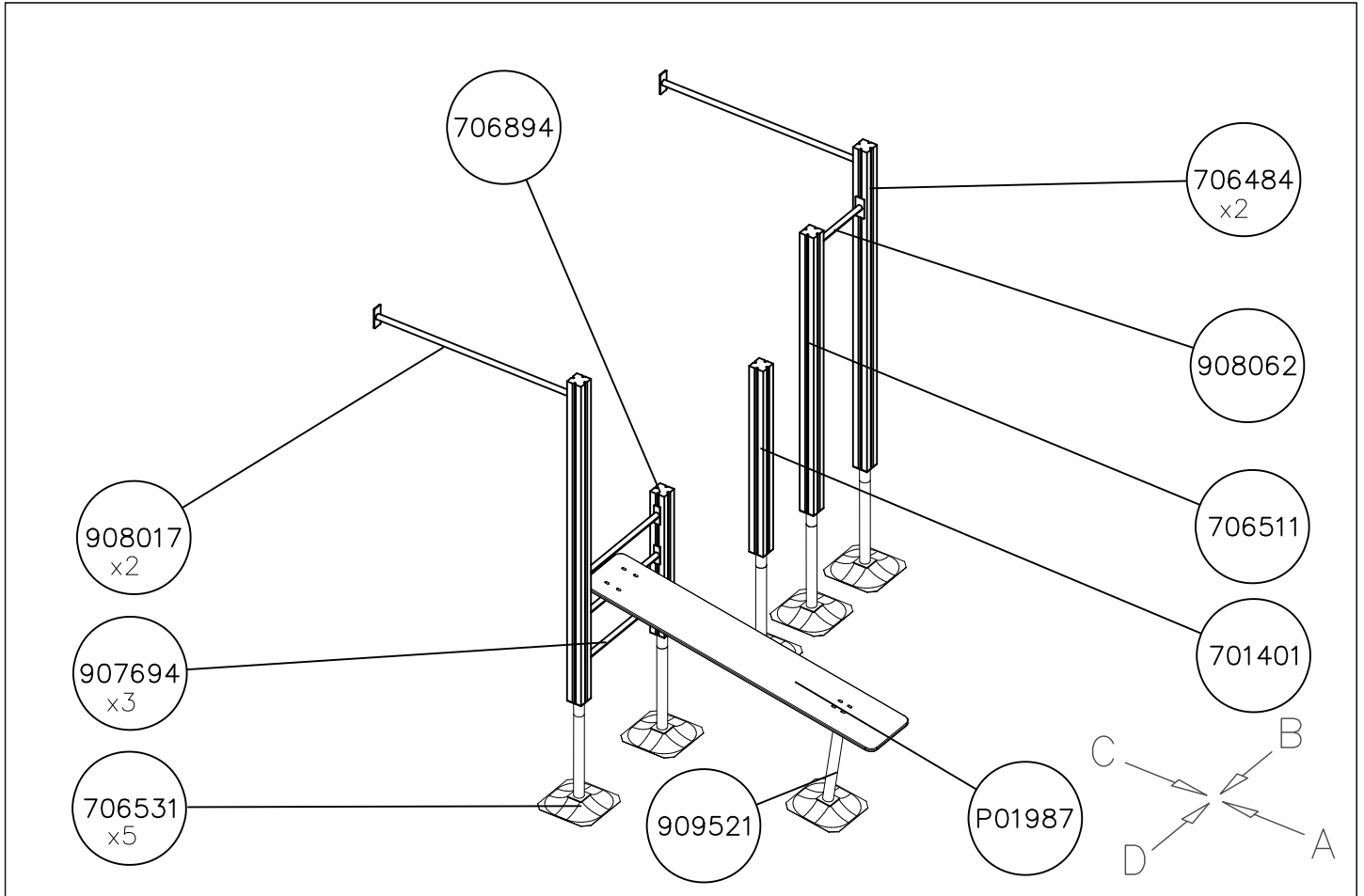

DATE: 21.10.2020

1:50

A

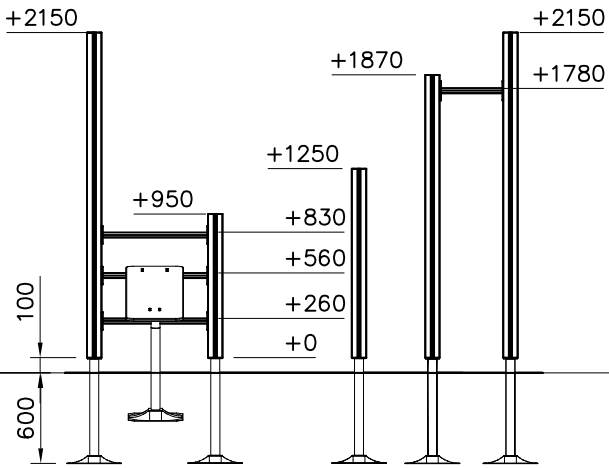

B

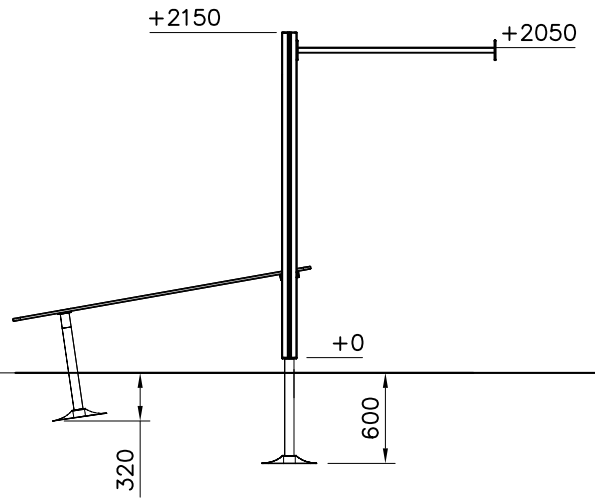

C

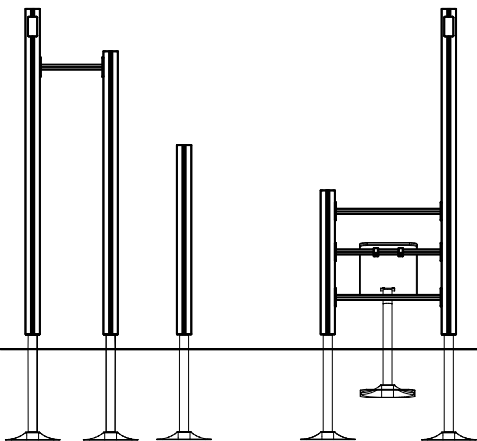

D

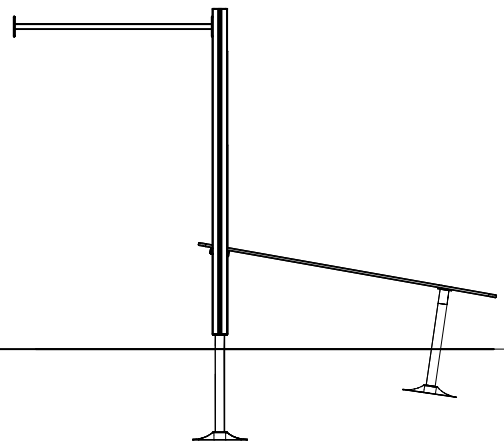

Max Falling Height 2300 mm

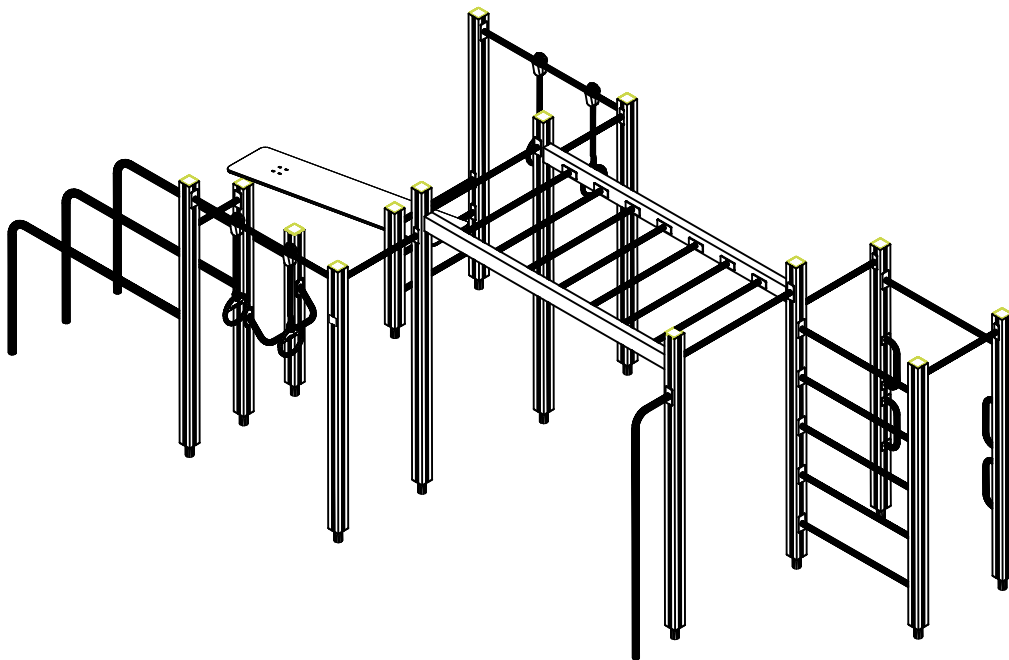
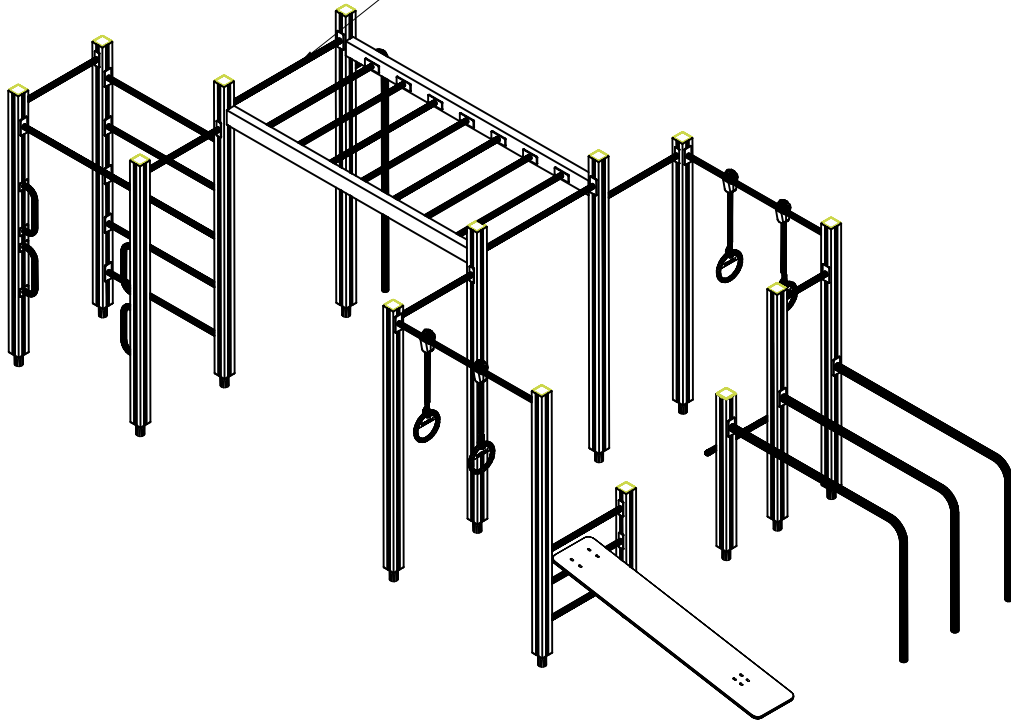

1. Tarkista tuoteosaluettelon ja osiin merkittyjen tuotenumeroiden avulla, että kaikki osat sisältyvät toimitukseen.
2. Valitse välineelle paikka ottaen huomioon valmistajan asennusohjeessa ilmoittamat turvaetäisyydet. Valitessasi välineen asennussuuntaa, huomioi mahdollinen altistuminen voimakkaalle auringonpaisteelle tai tuulelle. Tasoita alue ja tee ohjeen mukaiset perustustyöt. Varmista, että perustusosien alapuolinen maa on **tiivistetty riittävästi**. Tarvittaessa pohjamaa tulee vaihtaa murskeeseen tai vastaavaan kantavaan maainekseen. Iskua vaimentavan pintamateriaalin vahvuus määräytyy laskentakaavan perusteella, joka esitetään perustusohjeen lisäsivulla.
3. Välineen rungon pystystysohje esitetään sivulla 6. Yksityiskohtaiset kuvat asennuksesta on koottu erillisille ohjesivuille, joissa ne on ryhmitelty kiinnitystavan mukaan. Runkoon kiinnitettävistä komponenteista on erilliset moduuliohjeet. Noudata valmistajan asennusohjeessa ilmoittamia mitoituksia.
4. Tarkasta, että väline on suorassa ja perustukseltaan tukeva. Syväperusteisissa välineissä on suoritettava **riittävä maan tiivistäminen** kaivantojen täytön yhteydessä.
5. Tee käyttöönottotarkastus ennen välineen käyttöönottoa toimitukseen sisältyvän pöytäkirjan mukaisesti. Pöytäkirja tulee dokumentoida. Muista, että pääsy välineeseen tulee estää, kunnes se on valmis, turvallinen ja kaikki asennustarvikkeet on viety pois.

1. Kontrollera stycklistan och delarna i förpackningen med hjälp av produktnumren.
2. När du väljer platsen för utrustningen bör du beakta de säkerhetsavstånd som tillverkaren meddelat i monteringsanvisningarna. När du väljer monteringsriktning måste du beakta eventuell exponering för solsken eller vind. Jämna ut underlaget och utför grundarbetet i enlighet med instruktionerna. Säkra att marken under fundamentet är tillräckligt komprimerad. Vid behov kan man ersätta jorden med krossad sten eller motsvarande bärande jordmaterial. Styrkan på det slagdämpande ytmaterialet bestäms med hjälp av beräkningsformeln som presenteras på fundamentinstruktionernas tilläggsida.
3. Monteringsanvisningarna till utrustningens stomme finns på sidan 6. Detaljerade bilder av installationen har samlats på separata instruktionssidor, där de har grupperats enligt monteringsmetod. Det finns specifika modulanvisningar till de komponenter som ska sättas fast i stommen. Följ de dimensioner som tillverkaren gett i monteringsanvisningarna.
4. Kontrollera att utrustningen står rakt och stabilt. För utrustningar med djupt fundament måste man komprimera jorden ordentligt när man fyller igen groparna.
5. Innan utrustningen tas i bruk ska en slutbesiktning i enlighet med protokollet i leveransen utföras. Protokollet måste dokumenteras. Kom ihåg att tillträde till utrustningen måste förhindras tills den är färdig monterad, säker och alla monteringsstillbehör avlägsnats.

1. Use the parts list and the markings on the components to make sure that you have all of the necessary parts.
2. Choose a location for the product, taking into account the safety margins specified in the mounting instructions. When deciding on the orientation of the product, pay attention to potential sun and wind loads. Level the ground and prepare the foundations as instructed. Make sure that the ground underneath the foundations is solidly packed. If necessary, replace soil with wood chips or some other sturdy material. The thickness of the safety surfacing should be calculated using the formula supplied with the mounting instructions.
3. Assemble the frame of the product in accordance with the instructions on page 6. Detailed instructions for the different mounting alternatives are shown in the supplement. Separate instructions are provided for the modular components that will be attached to the frame. Please follow the stated measurements carefully.
4. Make sure that the product is mounted straight and firmly into the ground. Remember to pack the soil carefully when refilling the excavation around deep-mounted structures.
5. Inspect the installation thoroughly using the checklist provided. Document the completed checklist carefully. Remember to stop children from using the product until it has been fully built and safety-tested and all mounting equipment has been cleared away.

1. Überprüfen Sie die Lieferung auf Vollständigkeit, indem Sie das Teileverzeichnis mit der Lieferung abgleichen.
2. Wählen Sie einen Standort für das Gerät und berücksichtigen Sie die vom Hersteller in der Installationsanleitung genannten Sicherheitsabstände. Bei der Ausrichtung des Gerätes beachten Sie den möglichen Einfluss von starker Sonneneinstrahlung oder Wind. Ebenen Sie den Bereich und führen Sie die Fundamentarbeiten nach der Anleitung durch. Stellen Sie sicher, dass der Boden unter den Fundamentteilen ausreichend verdichtet ist. Wenn nötig, muss das Untergrundmaterial durch Split oder ein anderes tragfähiges Material ausgetauscht werden. Die Stärke des stoßdämpfenden Oberflächenmaterials wird auf Grundlage einer Formel berechnet, die im Anhang der Anleitung für die Fundamente dargestellt ist.
3. Die Aufbauanleitung für den Rahmen des Gerätes finden Sie auf Seite 6. Detaillierte Bilder der Installation sind auf gesonderten Anleitungsseiten zusammengestellt, auf denen sie nach ihrer Befestigungsweise geordnet sind. Für die am Geräterahmen befestigten Komponenten gibt es besondere Modulanleitungen. Halten Sie die in der Installationsanleitung vom Hersteller genannten Maße ein.
4. Überprüfen Sie, dass das Gerät in Waage steht und sicher am Boden verankert ist. Bei Geräten mit Tiefenfundamenten muss der Boden beim Auffüllen des Aushubs ausreichend verdichtet oder betoniert werden.
5. Führen Sie eine Inbetriebnahmeüberprüfung entsprechend des im Lieferumfang enthaltenen Protokolls durch, bevor das Gerät benutzt wird. Das Protokoll muss aktenkundig dokumentiert werden. Denken Sie daran, dass der Zugang zum Gerät verhindert werden muss, bis es fertig und sicher ist und alle Installationswerkzeuge entfernt sind.

1. Vérifier à l'aide de la liste des pièces et des numéros de produit marqués sur les pièces que la livraison comprend toutes les pièces nécessaires.
2. Choisir un bon emplacement pour l'équipement, compte tenu des distances de sécurité indiquées par le fabricant dans les instructions de montage. Tenir compte de l'exposition éventuelle aux forts rayons de soleil ou au vent lors du choix du sens de montage de l'équipement. Egaliser la surface de l'emplacement choisi et effectuer les travaux de fondation conformément aux instructions. S'assurer que le sol sous les pièces de fondation a été suffisamment compacté. Si besoin est, le sol de fondation doit être remplacé par des pierres concassées ou un matériau portant similaire. L'épaisseur du matériau de surface anti-choc est calculée selon la formule indiquée à la page supplémentaire des instructions de fondation.
3. Les instructions d'érection de l'ossature de l'équipement sont indiquées à la page 6. Les images détaillées du montage sont adjointes aux pages d'instruction séparées où elles sont groupées selon le mode de fixation. Des instructions modulaires séparées sont données pour les composants à fixer sur l'ossature. Respecter les mesures données par le fabricant dans les instructions de montage.
4. Vérifier que l'équipement est droit et que sa fondation est solide. Dans le cas des équipements dont la fondation se trouve sous le sol, le sol doit être suffisamment compacté lors du remplissage des trous.
5. Effectuer un contrôle de mise en service conforme au procès-verbal compris dans la livraison avant la mise en service de l'équipement. Ce procès-verbal doit être documenté. Ne pas oublier d'empêcher l'accès à l'équipement jusqu'à ce que celui-ci soit prêt et sûr et que tous les outils de montage aient été enlevés.

		
<p>$h < 600$</p> <p>Without movement and therefore without Impact Area</p>	<p>Totally hard surfaces.</p> <p>Note. Lappset does <u>not recommend</u> totally hard surfaces at all.</p>	<p>E.g. concrete or asphalt</p> 
<p>$h < 600$</p> <p>With movement e.g. rocking</p>	<p>Materials with very limited impact attenuating properties.</p>	<p>E.g. wood</p> 
<p>$h < 1000$</p>	<p>Materials with significant impact attenuating properties.</p>	<p>fine gravel 0–8 mm</p>  <p>grass</p>  <p>unsorted sand</p> 
<p>$h < 3000$</p>	<p>Loose fill material</p> <p>E.g. sand/gravel 0,25...8 mm D60/D10<3,0 Woodchips 5...30 mm bark 20...80 mm</p>	 <p>\underline{S} \underline{h}</p> <p>30 cm < 2,0 m</p> <p>40 cm < 3,0 m</p>
	<p>Syntethic granulates</p> <p>\underline{S} \underline{h}</p> <p>40 mm ~> 1,2...1,3 m</p> <p>50 mm ~> 1,5...1,7 m</p> <p>60 mm ~> 1,8...2,0 m</p> <p>70 mm ~> 2,1...2,5 m</p> <p>Note. For accurate values, see manufacturer's instructions.</p>	



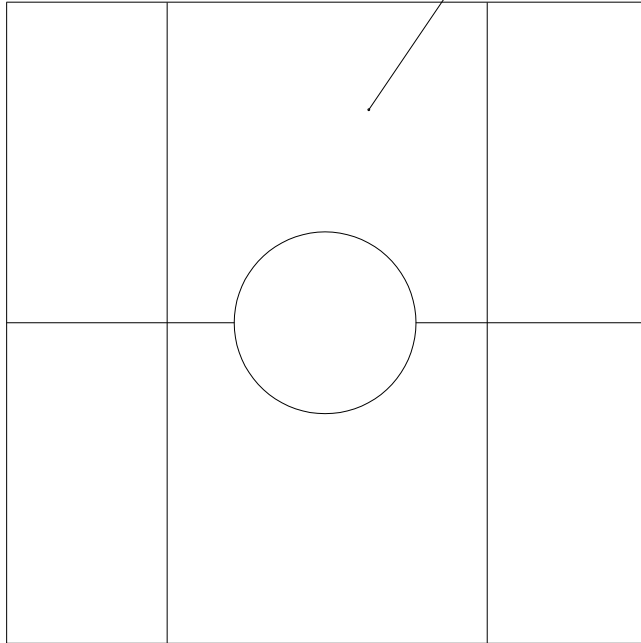

REMOVE SAFETY SURFACE/SAND/GRAVEL
TO CHECK FOUNDATION

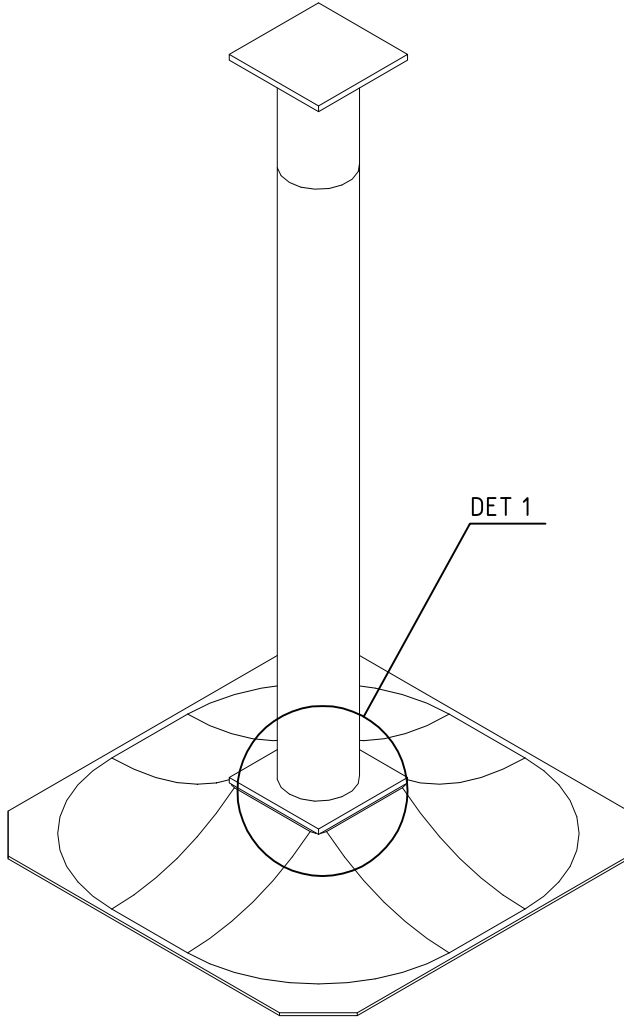

REMOVE SAFETY SURFACE/SAND/GRAVEL
TO CHECK FOUNDATION

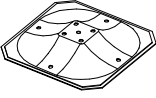



①	909511	PCS	②	909519	PCS
		1			1
③	909637	PCS	④	909638	PCS
		4			8
	M10			Ø20/10.5	
⑤	909639	PCS			PCS
		4			
	M10x25				
		PCS			PCS
		PCS			PCS
		PCS			PCS
		PCS			PCS
		PCS			PCS

DET 1

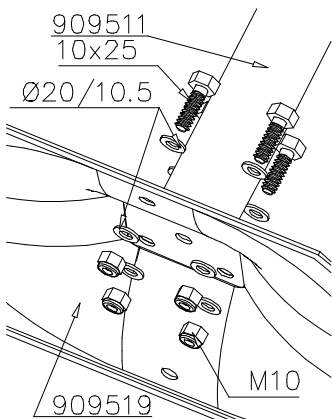

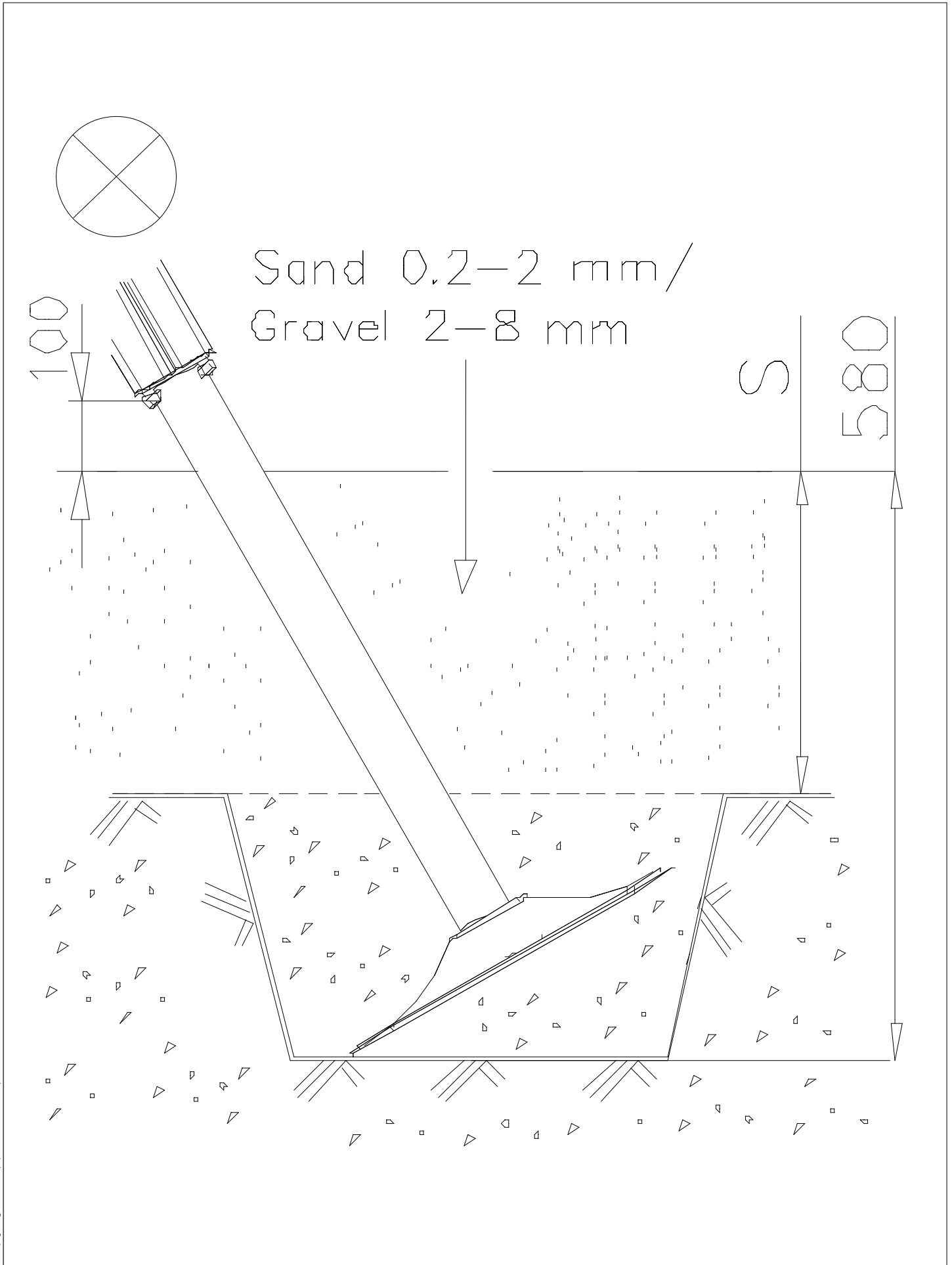



Tuotekyltti tulee tuotteen mukana yhdellä seuraavista tavoista:

1) Metallinen tuotekyltti ja kiinnitysruuvit

- Kiinnitä tuotekyltti ruuveilla tolppaan noin 2 metrin korkeuteen kuvan 1 mukaisesti.

2) Tuotekylttitarra

- Puhdista maalattu metalli- tai vaneripinta pölystä ja kosteudesta. Liimaa tarra kuvan 2 mukaisesti.
- Huom. Älä kiinnitä tarraa karheapintaiseen laminaattiin tai maalattuun puuhun.

Vår produktmärkning levereras på ett av följande sätt:

1) Produktskylt i metall

- Fäst skylten med de medföljande skruvarna

2) Självhäftande produktetikett

- Rengör den pulverlackerade metallytan eller laminatyten så att den blir fri från smuts och fukt. Fäst etiketten enligt fig. 2.
- Obs! Fäst ej etiketten på detaljer med skrovlig yta eller på målat trä.

Product label is delivered by one of following ways:

1) Metal product label and screws

- Fasten the label with screws.

2) Label sticker

- Clean the painted metal or plywood surface from dirt and moisture. Fasten the sticker as shown in the figure 2.
- Note. Do not attach the sticker to rough surfaced laminate or painted wood.

La plaque d'informations produit est livrée sous l'une de ces 3 formes :

1) Plaque métallique et vis

- Fixez la plaque à l'aide des vis.

2) Etiquette autocollante

- Avant de coller l'étiquette, nettoyez le composant métallique peint ou la plaque de contreplaqué, de toute saleté. La surface doit être sèche (voir image 2).
- Attention, ne pas coller l'étiquette sur une surface lamellé-collée irrégulière ou sur du bois peint.

Die Auslieferung des Produktaufklebers erfolgt auf eine dieser Arten:

1) Produkt-Schild aus Metall incl. Schrauben

- Die Befestigung des Schildes erfolgt mittels der Schrauben.

2) Aufkleber

- Entfernen Sie zunächst Schmutz und Feuchtigkeit vom lackierten Metall bzw. von der Holzoberfläche und bringen Sie den Aufkleber wie im Bild oben rechts beschrieben auf den gesäuberten Untergrund auf.
- Beachten Sie: Bringen Sie den Aufkleber nicht auf raues laminiertes oder lackiertes Holz an.



LAPPSET®
BETON FOUNDATION

FOOT

DATE: 27.10.2015

1(1)

② 905104	PCS		PCS
	4		
 M10	PCS		PCS



905104

LAPPSET® DEEP FOUNDATION



FOOT

DATE: 15.5.2018

1(1)

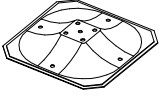

①	909511	PCS	②	909519	PCS
		1			1
	90x90x650			50x380x380	

③	909637	PCS	④	909638	PCS
		4			8
	M10			Ø20/10.5	

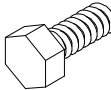
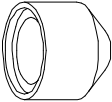
⑤	909639	PCS	⑥	905104	PCS
		4			4
	M10x25			M10	

OPTION FOOT

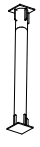
①	911155	PCS			PCS
		1			
	90x90x650				