

LAPPSET®

FINNO







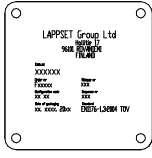

ASENNUSOHJE
MONTERINGSANSVISNING
INSTALLATION INSTRUCTION
AUFBAUANLEITUNG
NOTICE D'INSTALLATION

DATE: 14.4.2020

Q10027-2

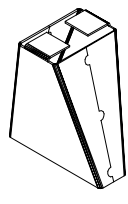
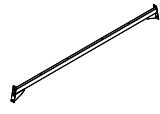
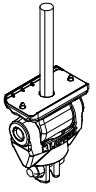
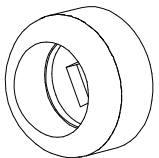
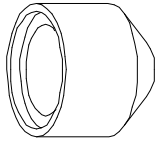
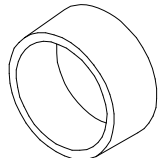
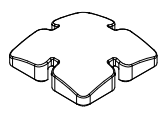
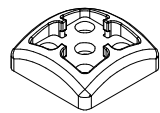
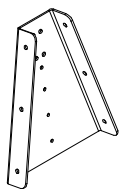

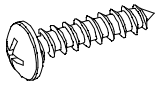
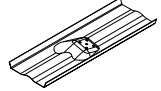
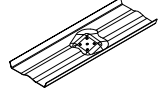
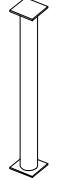
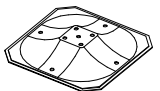
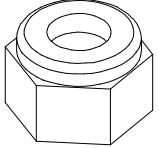
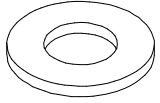
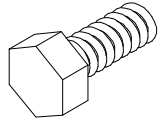
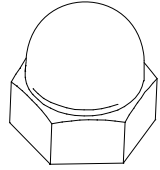
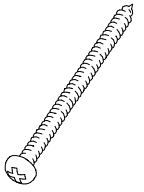
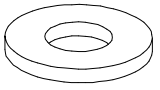
DATE: 14.4.2020

702286  65x65	PCS 1	706564-604  L2650	PCS 6	900965  M10	PCS 8	903149  M12x30	PCS 8	904317  L2940	PCS 1	904333  L2940	PCS 2
904904 	PCS 8	905090  Ø45	PCS 18	905104  M10	PCS 24	905115  Ø30	PCS 18	905138 	PCS 6	905196 	PCS 6
905991 	PCS 2	909347  M12x35	PCS 18	909506  Ø3.5x13	PCS 4	909507  L 1000	PCS 2	909508  L 1000	PCS 2	909511  L650	PCS 6
909519 	PCS 2	909637  M10	PCS 24	909638  Ø20/10.5	PCS 64	909639  M10x25	PCS 32	909644  M12	PCS 8	980131  Ø6x60	PCS 24
980154  Ø24x13	PCS 34	999561  GLUE 4101 ergo 10 g 10g	PCS 1		PCS		PCS		PCS		PCS
	PCS		PCS		PCS		PCS		PCS		PCS
	PCS		PCS		PCS		PCS		PCS		PCS

- EN/AS Impact Area 48.1 m²
- Falling Space 48.1 m²

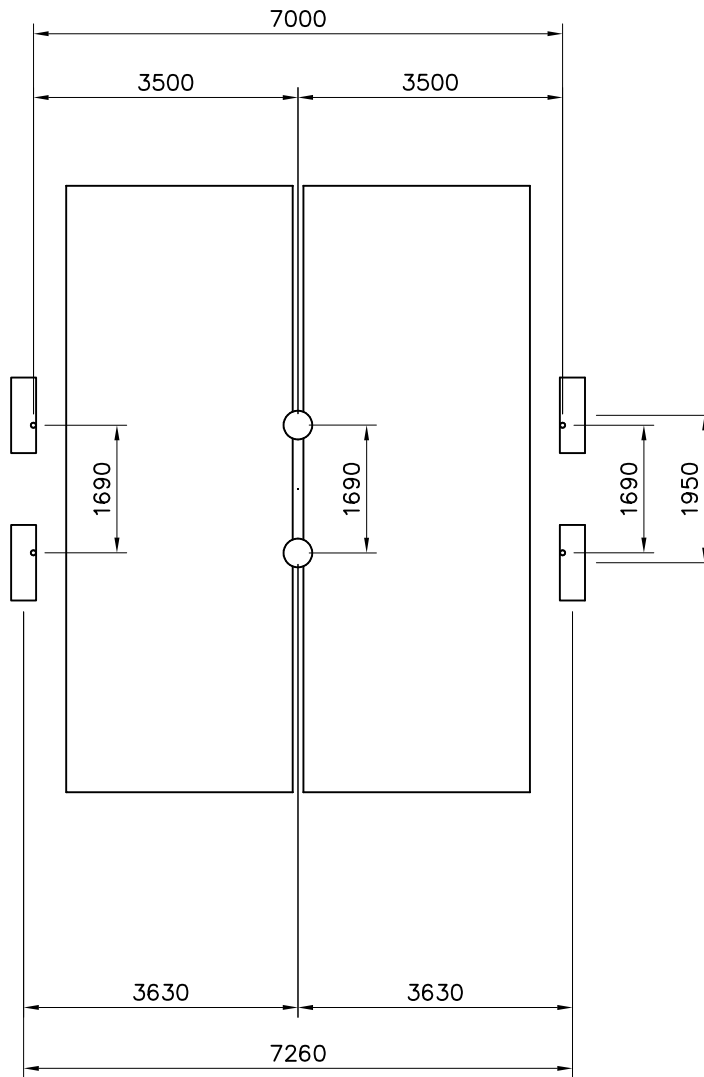
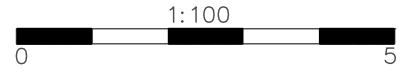

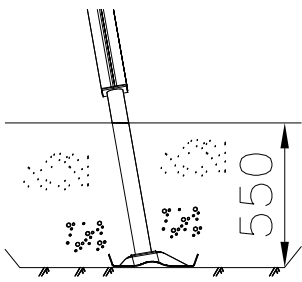
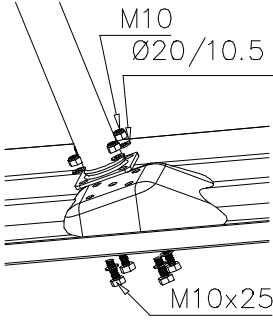
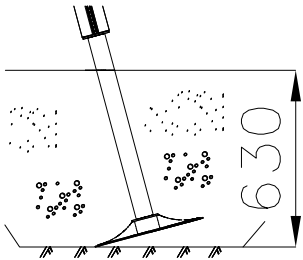
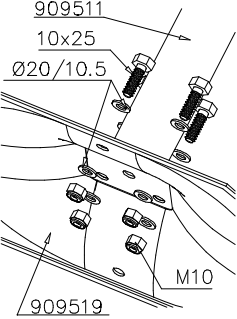
 <p>550</p>	 <p>M10 Ø20/10.5 M10x25</p>	 <p>630</p>
 <p>909511 10x25 Ø20/10.5 M10 909519</p>		

- EN/AS Impact Area 48.1 m²
- Falling Space 48.1 m²
Max Falling Height 1400 mm

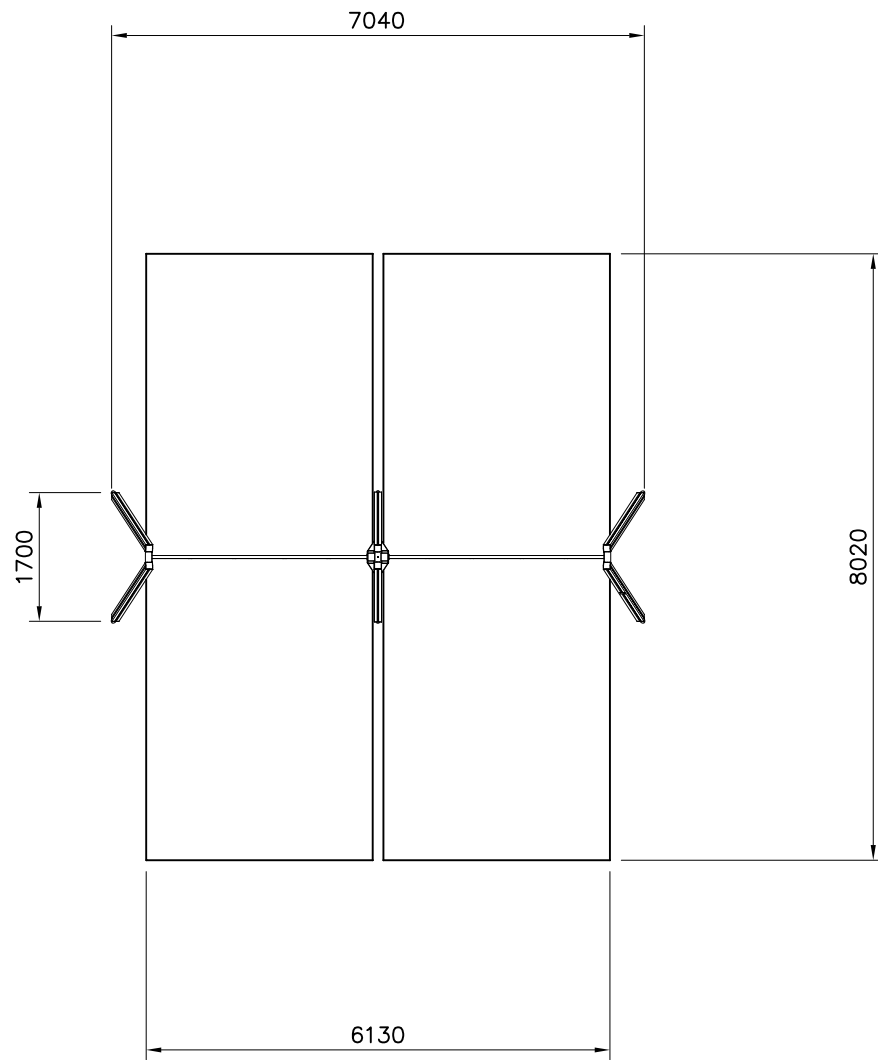

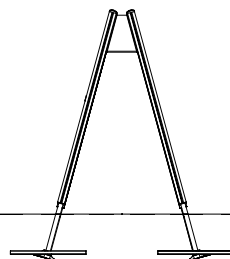
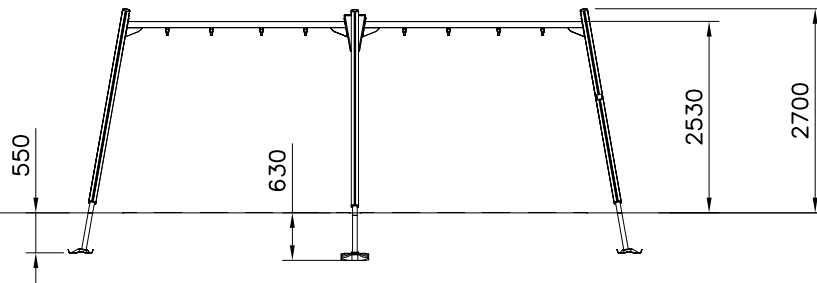

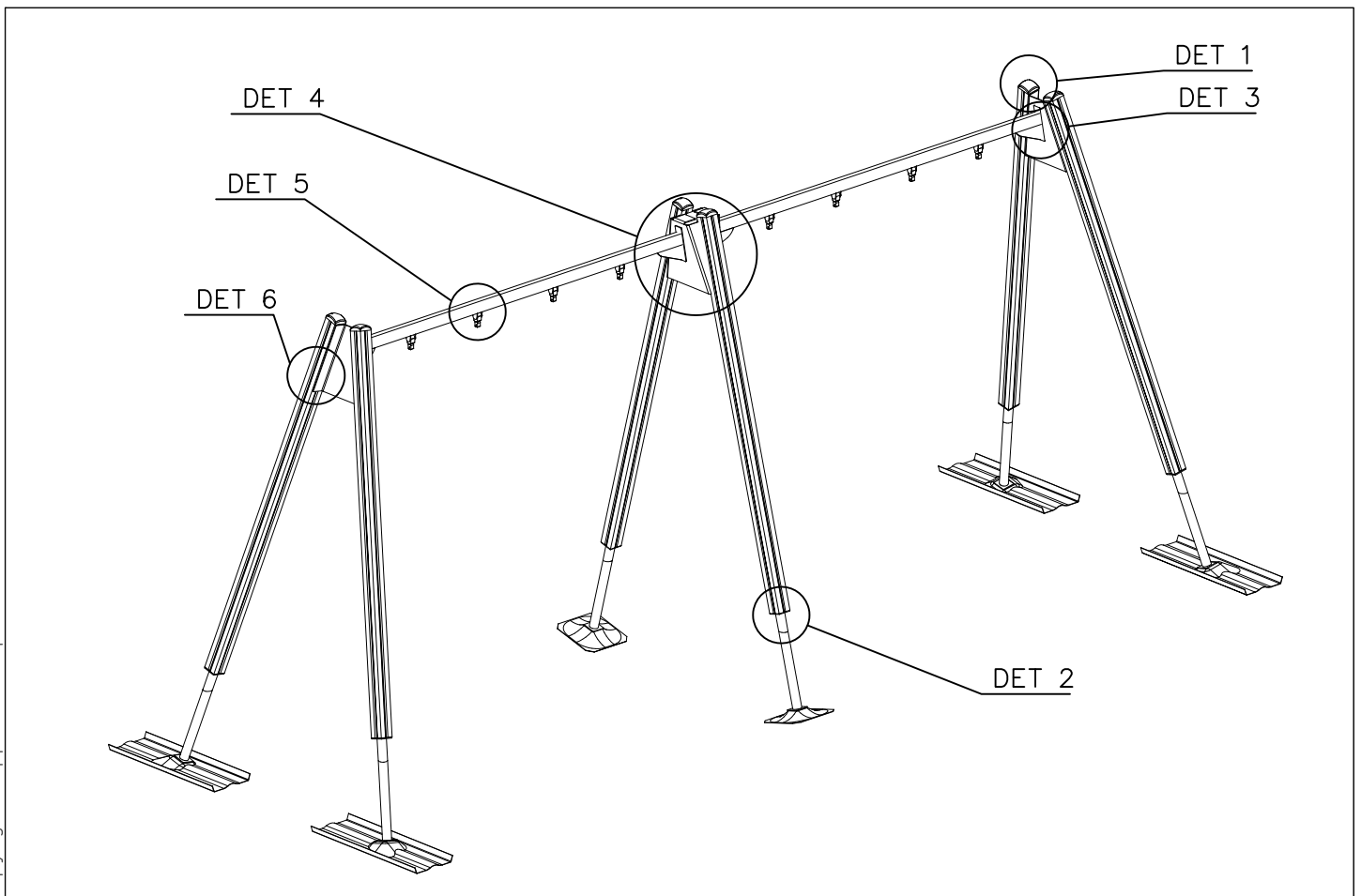
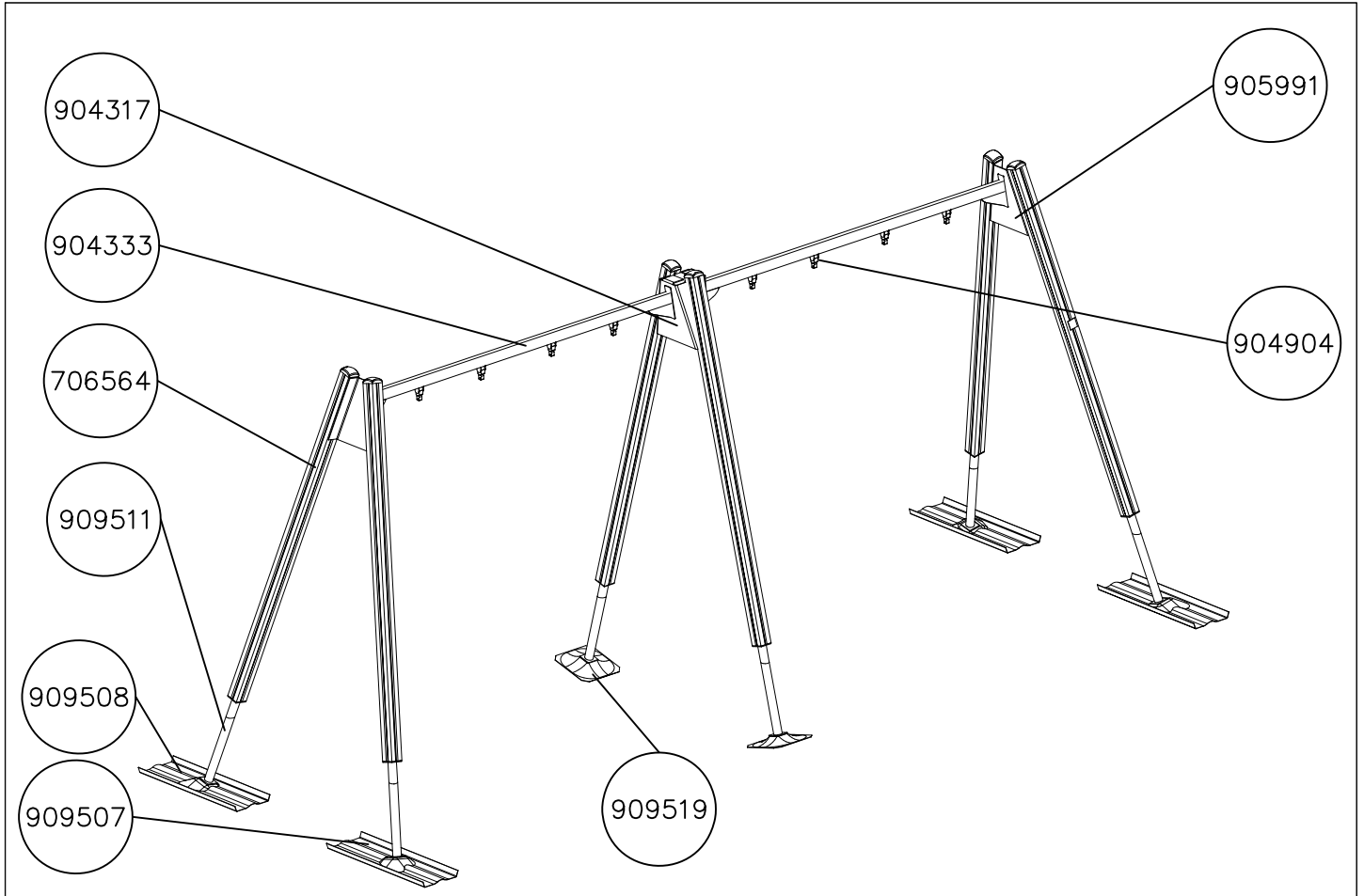

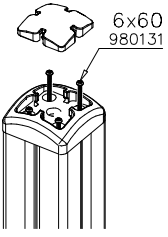
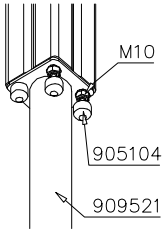
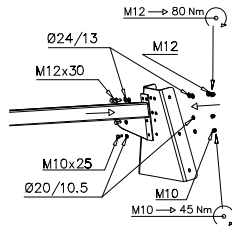
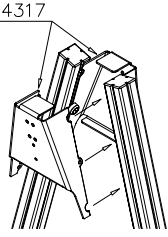
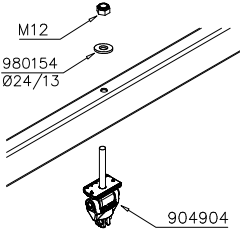
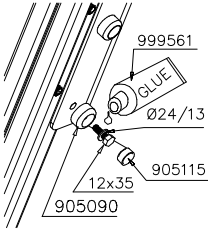

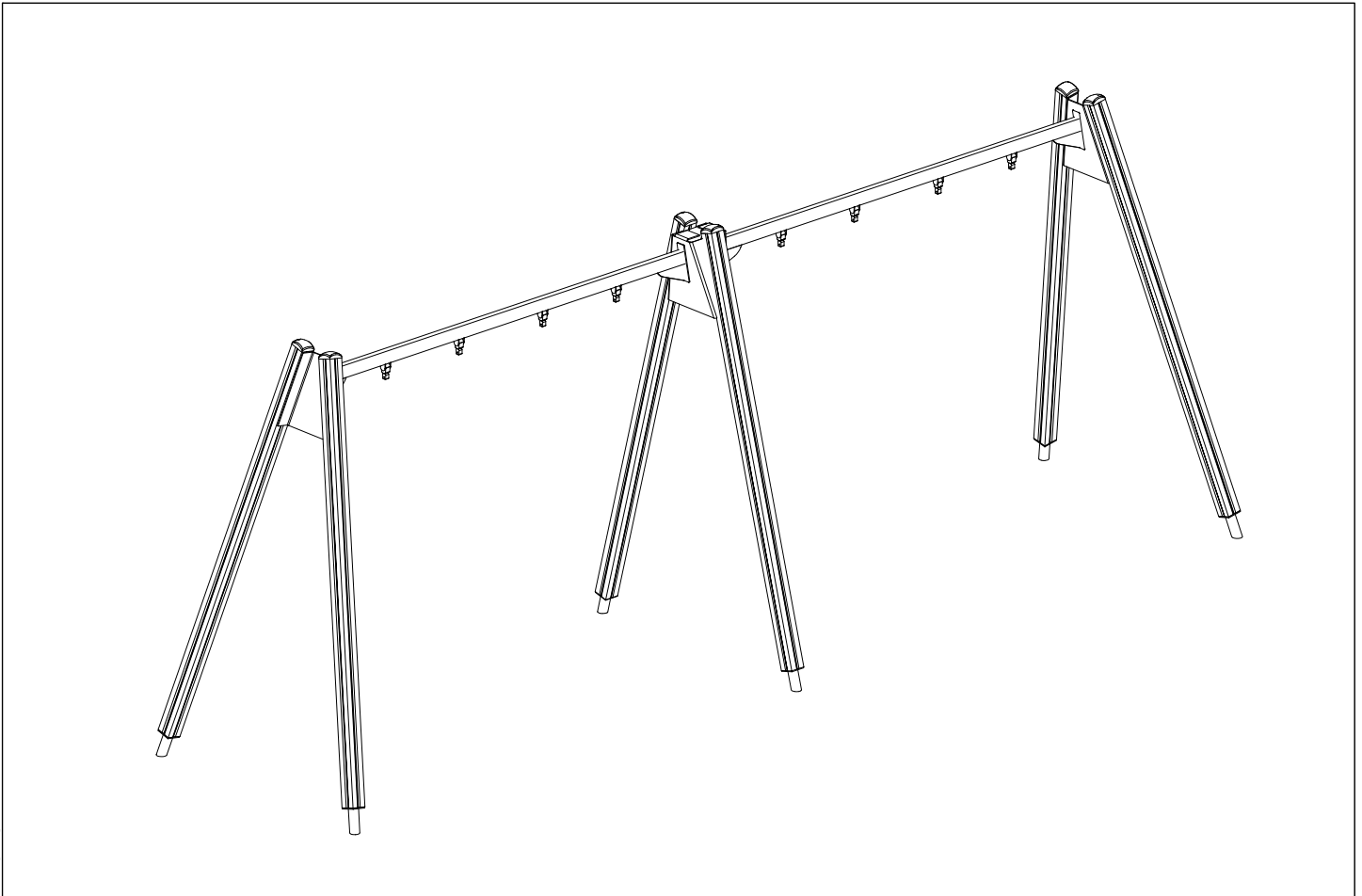
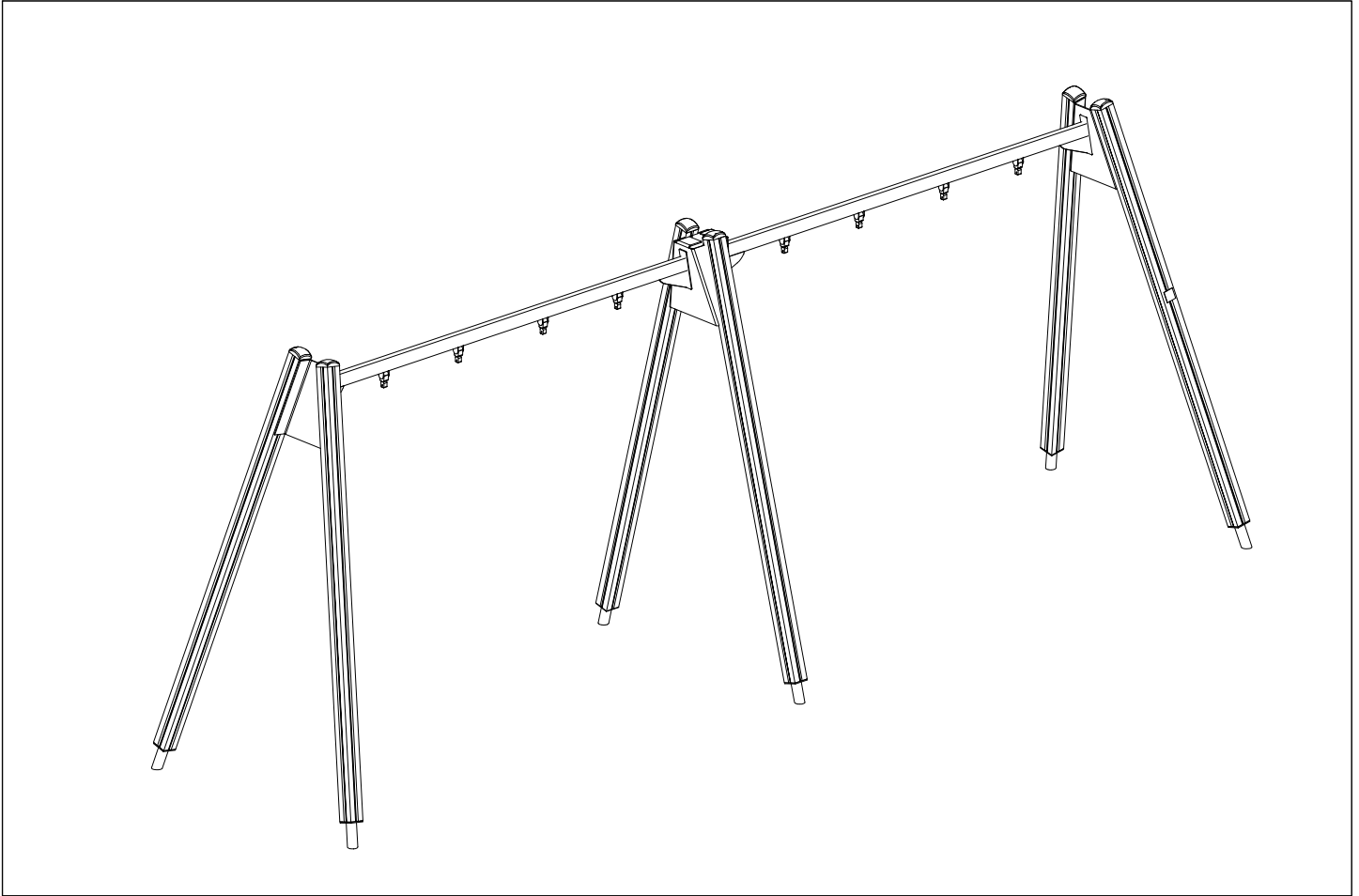

<p>DET 1</p> 	<p>DET 2</p> 	<p>DET 3</p> 	<p>DET 4</p> 
<p>DET 5</p> 	<p>DET 6</p> 		

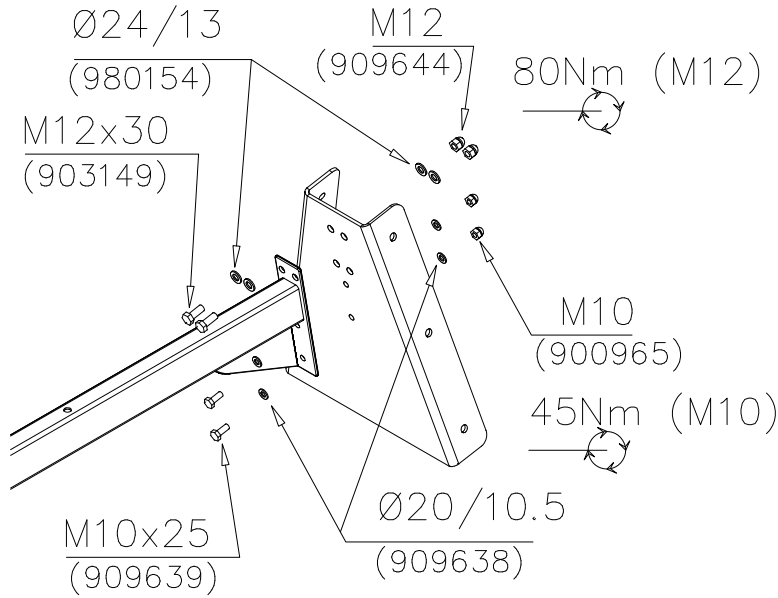



DET A

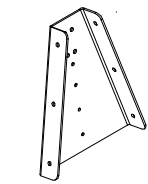

-  M12x30 2 pcs
-  Ø24/13 4 pcs
-  M12 2 pcs
-  M10x25 2 pcs
-  Ø20/10.5 4 pcs
-  M10 2 pcs
-  905991 1 pcs

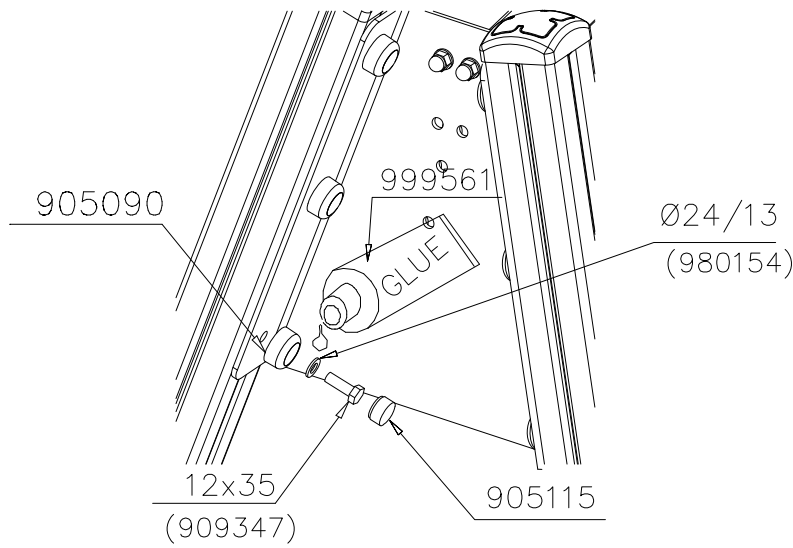
DET A1



-  M12x35 6 pcs
-  Ø24/13 6 pcs
-  Ø45 6 pcs
-  Ø30 6 pcs
-  GLUE

DET B

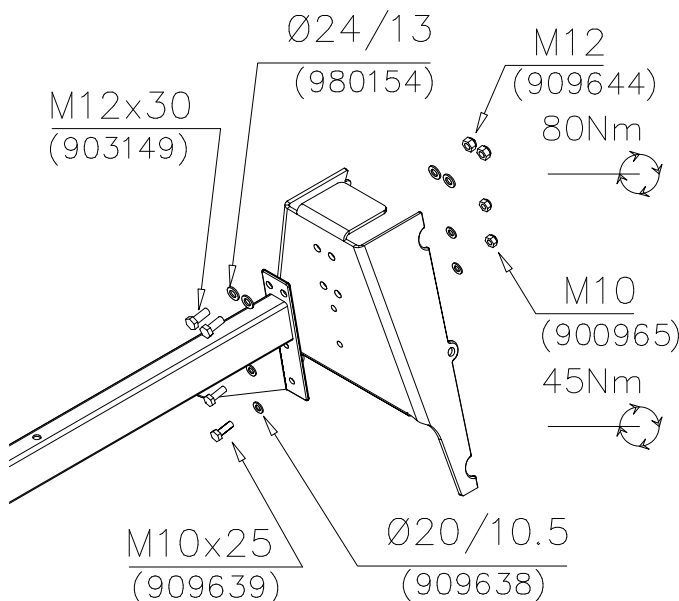

-  M12x30 2 pcs
-  Ø24/13 4 pcs
-  M12 2 pcs
-  M10x25 2 pcs
-  Ø20/10.5 4 pcs
-  M10 2 pcs

DET B

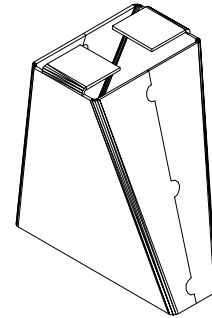
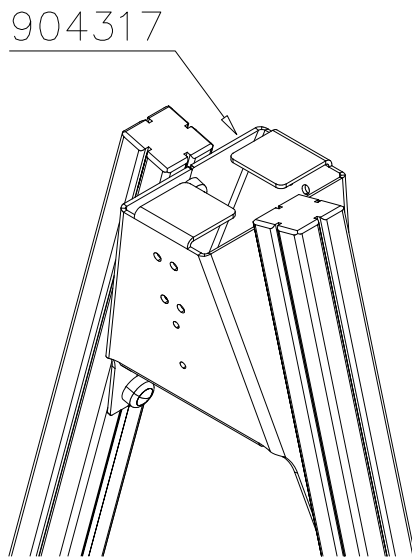

904317

DET B1

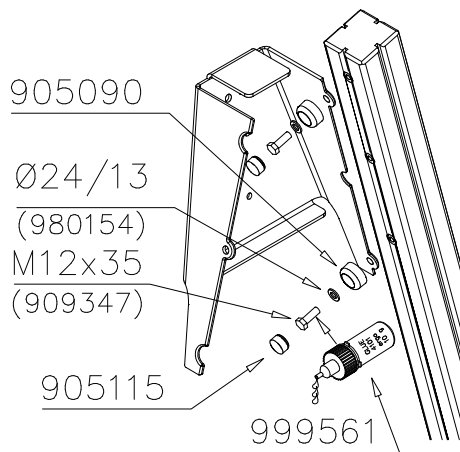

M12x35 6 pcs



Ø24/13 6 pcs

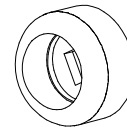

Ø45 6 pcs

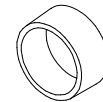

Ø30 6 pcs



GLUE

DET C

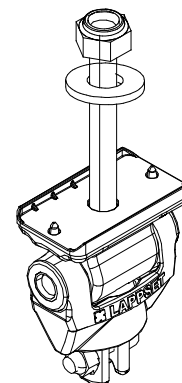
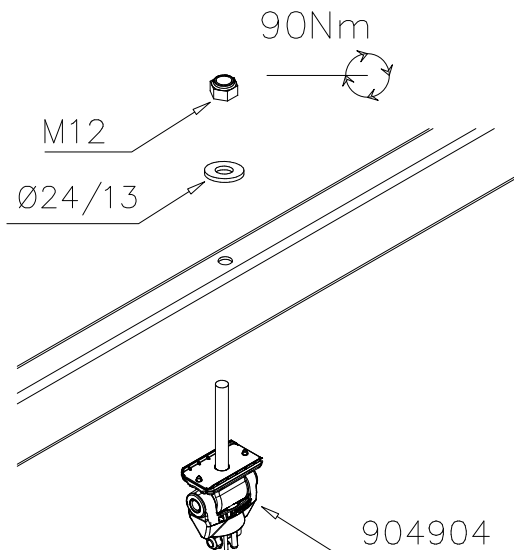

904904

DET D

90Nm

M12x110 (906499)

Ø24/13 (980154)

901958

M8x35

Ø24/13 (980154)

M12 (902234)

M8

CUT EXTRA CHAIN

M12x110 2 pcs

Ø24/13 4 pcs

M12 2 pcs

901958 1 pcs

DET D

903577

903577 1 pcs

DET E

6x60 980131

980131 4 pcs

905138 1 pcs

905196 1 pcs

REF: SWING
DATE: 29.6.2022

DET F

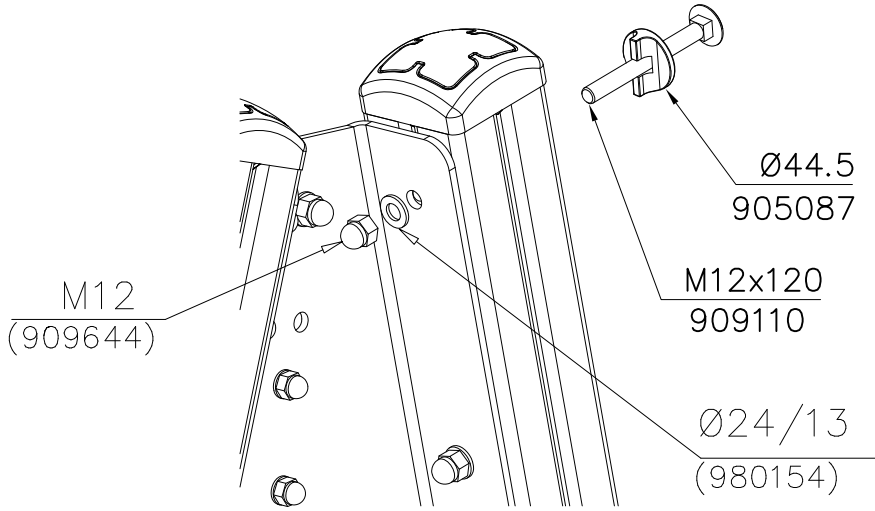

DET G

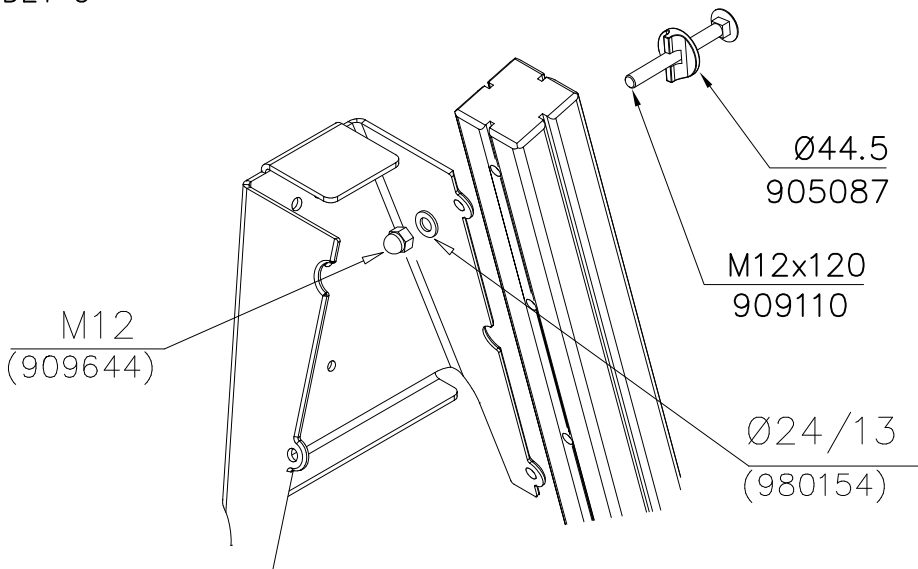

LAPPSET®
BETON FOUNDATION

FOOT

DATE: 27.10.2015

1(1)

② 905104	PCS		PCS
	4		
 M10	PCS		PCS



905104

**Tuotekyltti tulee tuotteen mukana yhdellä seuraavista tavoista:****1) Metallinen tuotekyltti ja kiinnitysruuvit**

- Kiinnitä tuotekyltti ruuveilla tolppaan noin 2 metrin korkeuteen kuvan 1 mukaisesti.

2) Tuotekylttitarra

- Puhdista maalattu metalli- tai vaneripinta pölystä ja kosteudesta. Liimaa tarra kuvan 2 mukaisesti.
- Huom. Älä kiinnitä tarraa karheapintaiseen laminaattiin tai maalattuun puuhun.

Vår produktmärkning levereras på ett av följande sätt:**1) Produktskylt i metall**

- Fäst skylten med de medföljande skruvarna

2) Självhäftande produktetikett

- Rengör den pulverlackerade metallytan eller laminatyten så att den blir fri från smuts och fukt. Fäst etiketten enligt fig. 2.
- Obs! Fäst ej etiketten på detaljer med skrovlig yta eller på målat trä.

Product label is delivered by one of following ways:**1) Metal product label and screws**

- Fasten the label with screws.

2) Label sticker

- Clean the painted metal or plywood surface from dirt and moisture. Fasten the sticker as shown in the figure 2.
- Note. Do not attach the sticker to rough surfaced laminate or painted wood.

La plaque d'informations produit est livrée sous l'une de ces 3 formes :**1) Plaque métallique et vis**

- Fixez la plaque à l'aide des vis.

2) Etiquette autocollante

- Avant de coller l'étiquette, nettoyez le composant métallique peint ou la plaque de contreplaqué, de toute saleté. La surface doit être sèche (voir image 2).
- Attention, ne pas coller l'étiquette sur une surface lamellé-collée irrégulière ou sur du bois peint.

Die Auslieferung des Produktaufklebers erfolgt auf eine dieser Arten:**1) Produkt-Schild aus Metall incl. Schrauben**

- Die Befestigung des Schildes erfolgt mittels der Schrauben.

2) Aufkleber

- Entfernen Sie zunächst Schmutz und Feuchtigkeit vom lackierten Metall bzw. von der Holzoberfläche und bringen Sie den Aufkleber wie im Bild oben rechts beschrieben auf den gesäuberten Untergrund auf.
- Beachten Sie: Bringen Sie den Aufkleber nicht auf raues laminiertes oder lackiertes Holz an.