

LAPPSET®

AREENA



ASENNUSOHJE
MONTERINGSANSVISNING
INSTALLATION INSTRUCTION
AUFBAUANLEITUNG
NOTICE D'INSTALLATION

DATE: 9.4.2020

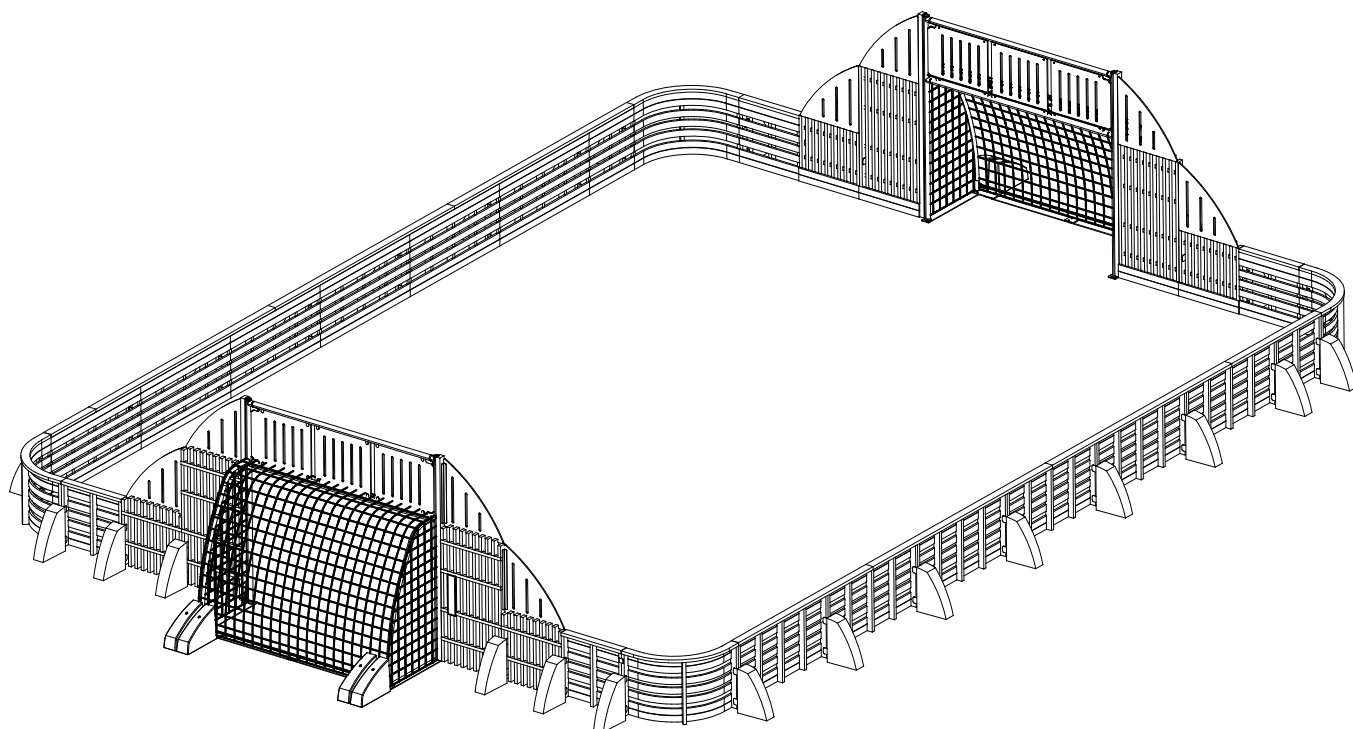
Q14686

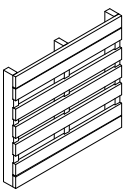
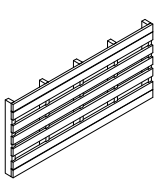
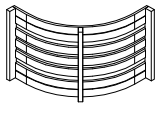
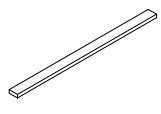
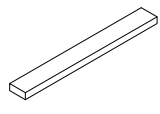
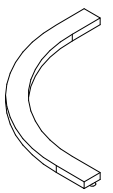
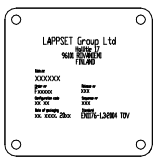
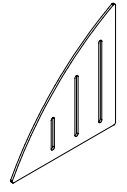
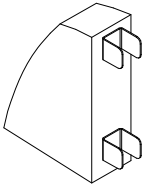
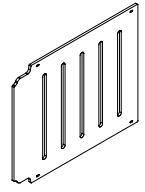
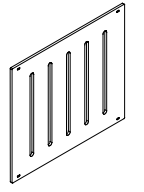
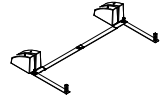
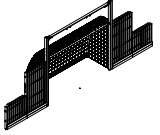
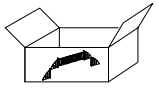
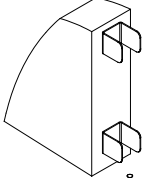
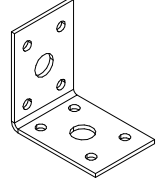
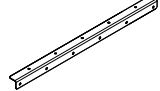
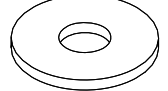

DATE: 9.4.2020

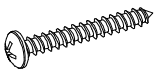
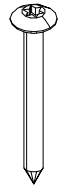
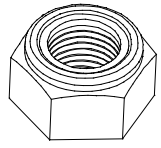
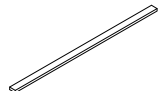
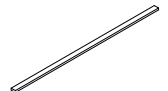
 702019 L 1000	PCS 6	 702021 L 2000	PCS 12	 702038	PCS 4	 702227 L 2000	PCS 1	 702228 L 1000	PCS 5	 702248	PCS 4
 702286 65x65	PCS 1	 704250-705 990x980x15	PCS 8	 704627	PCS 24	 707204-705 15x814x992	PCS 4	 707208-705 15x814x925	PCS 2	 707230	PCS 2
 708368	PCS 2	 708369	PCS 2	 708385	PCS 4	 902434	PCS 54	 904900 45x45x3x875	PCS 8	 905051 Ø24/8.4	PCS 156
 909203 M8x75	PCS 78	 980114 Ø4x20	PCS 4	 980128 Ø7x40	PCS 108	 980150 M8	PCS 78	 P01444 L 3000	PCS 1	 P01445 L 4000	PCS 5
	PCS		PCS		PCS		PCS		PCS		PCS
	PCS		PCS		PCS		PCS		PCS		PCS

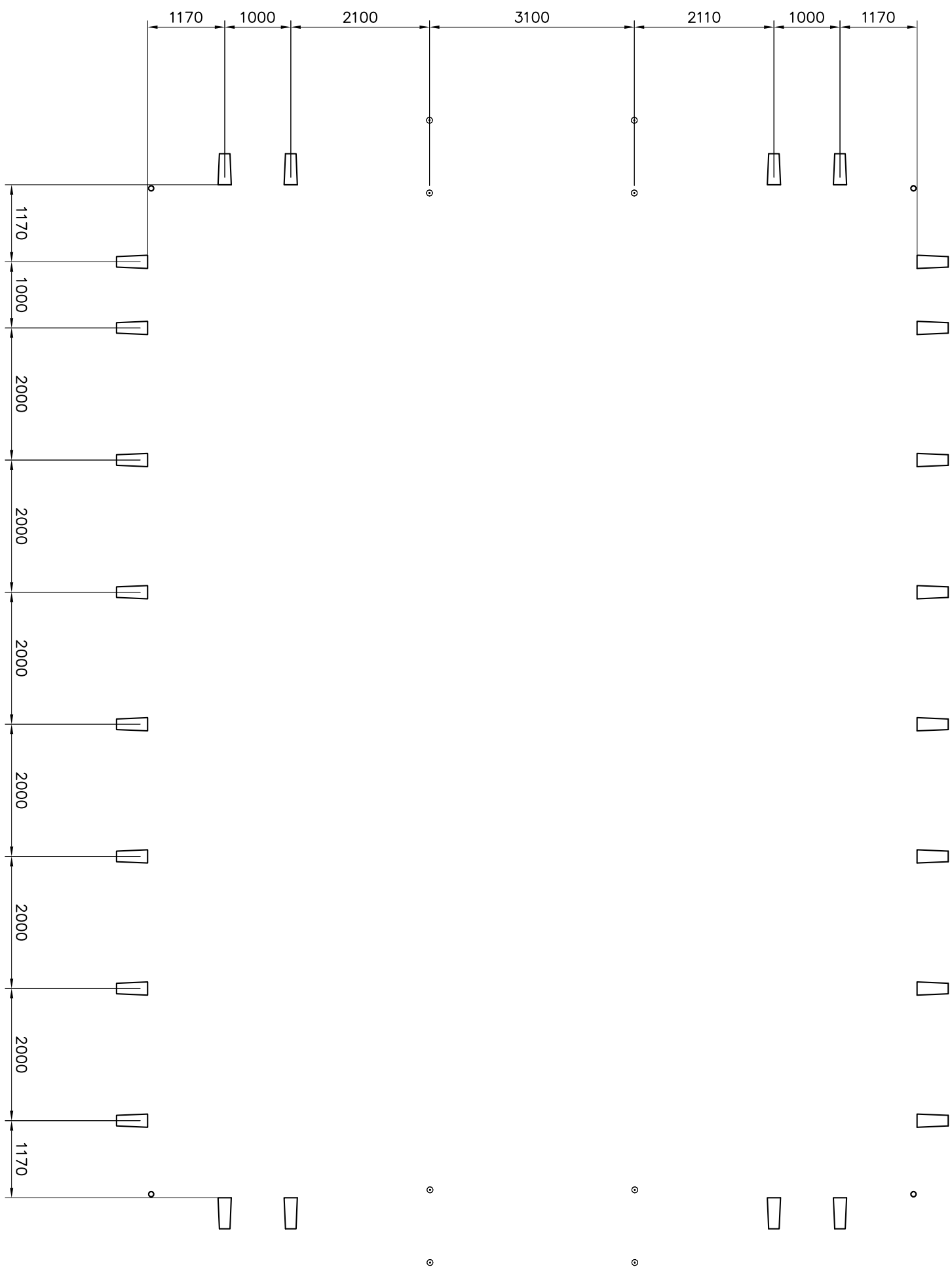
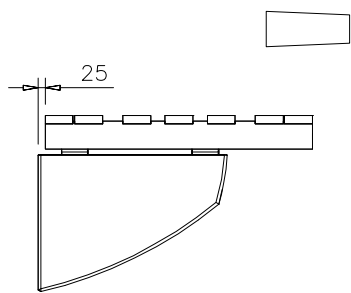

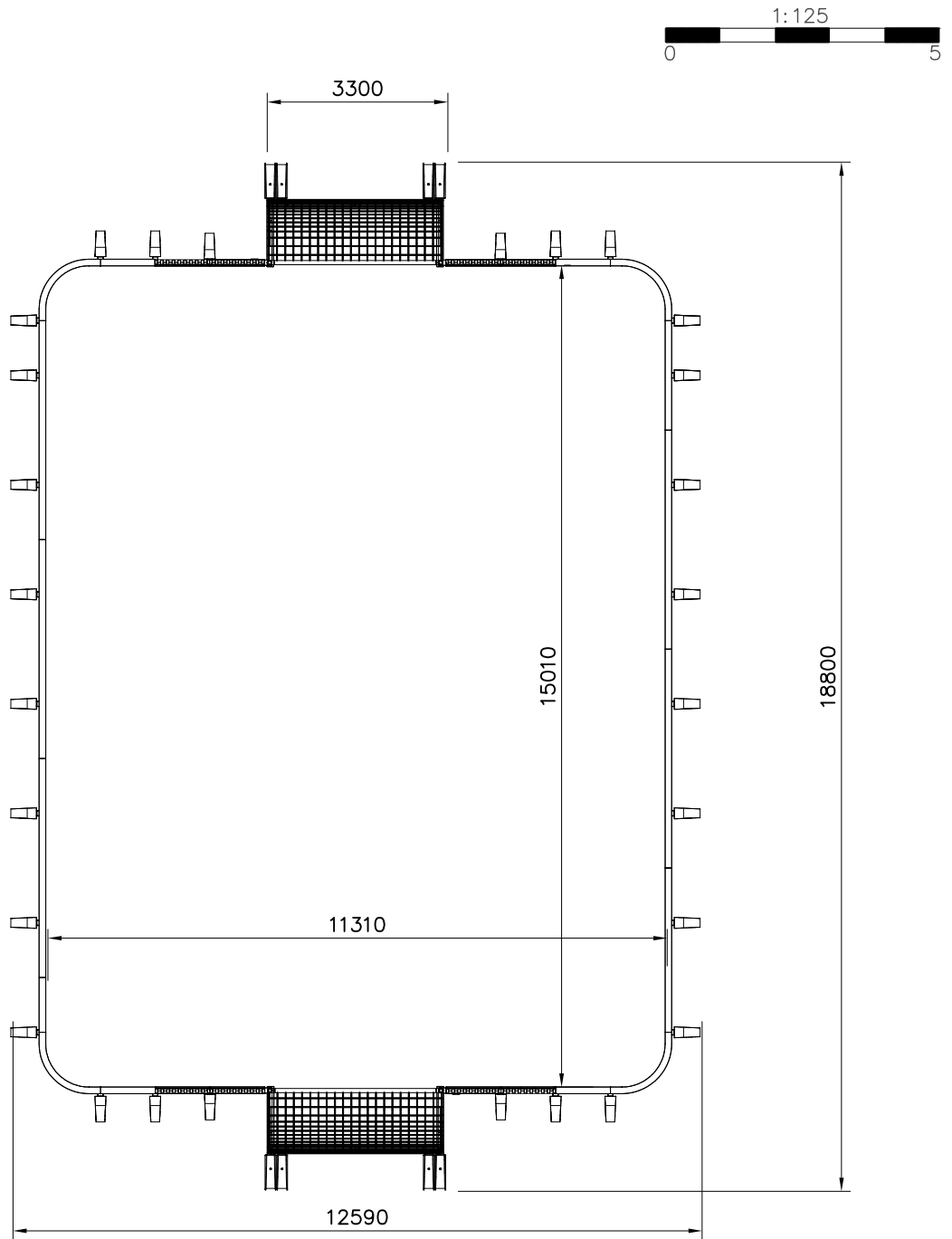

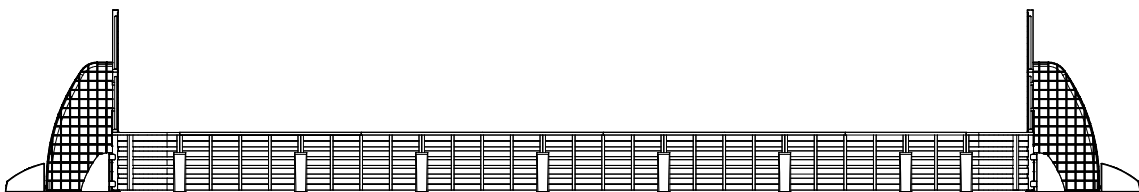
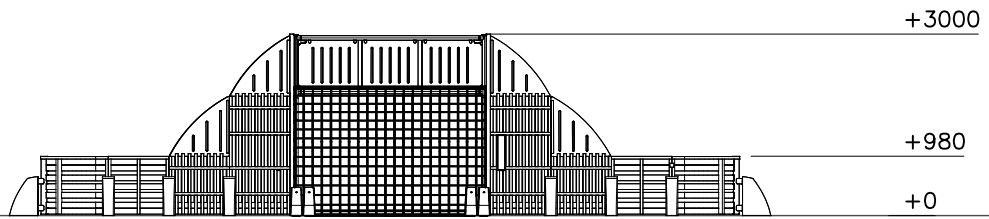

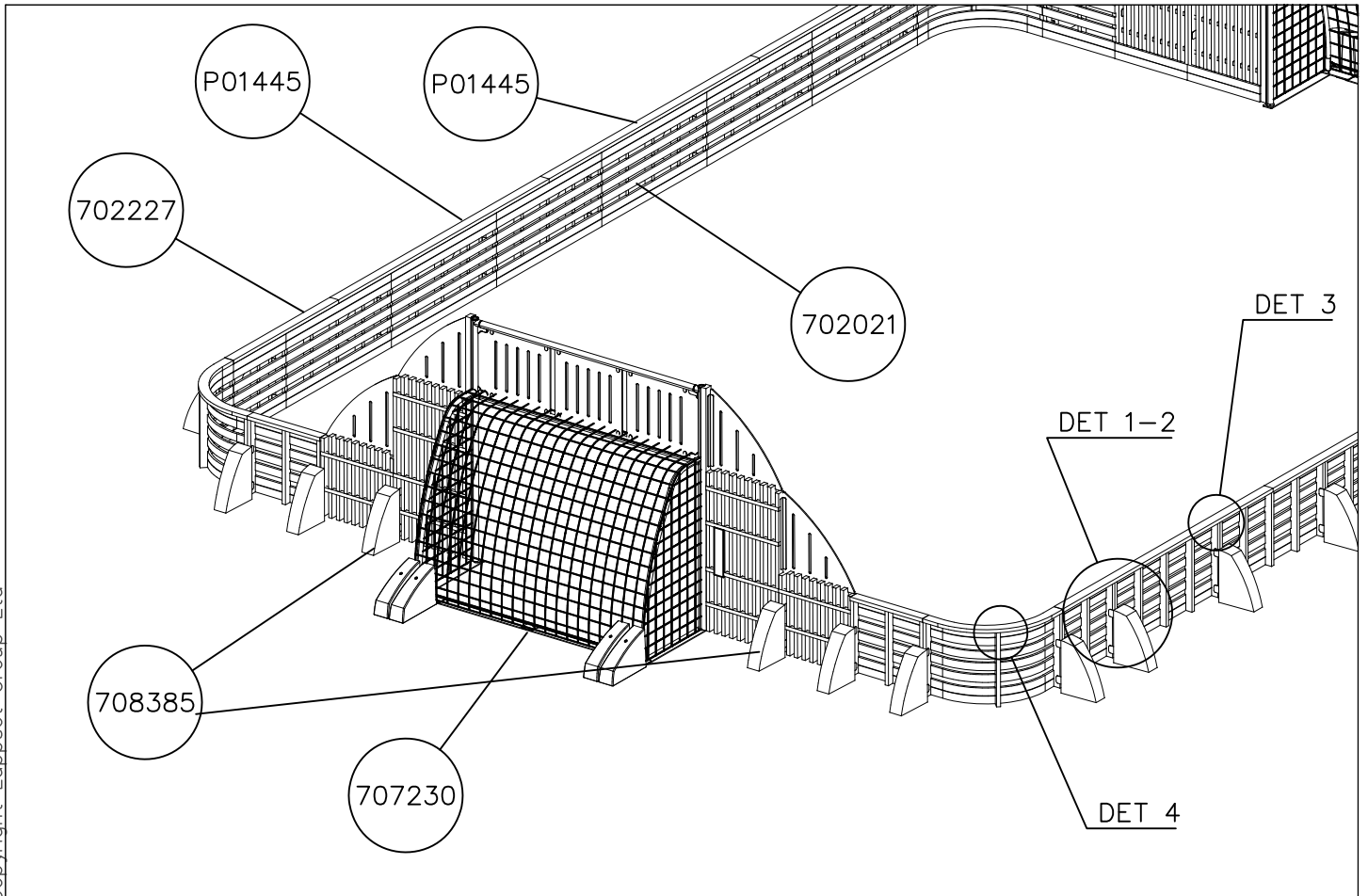
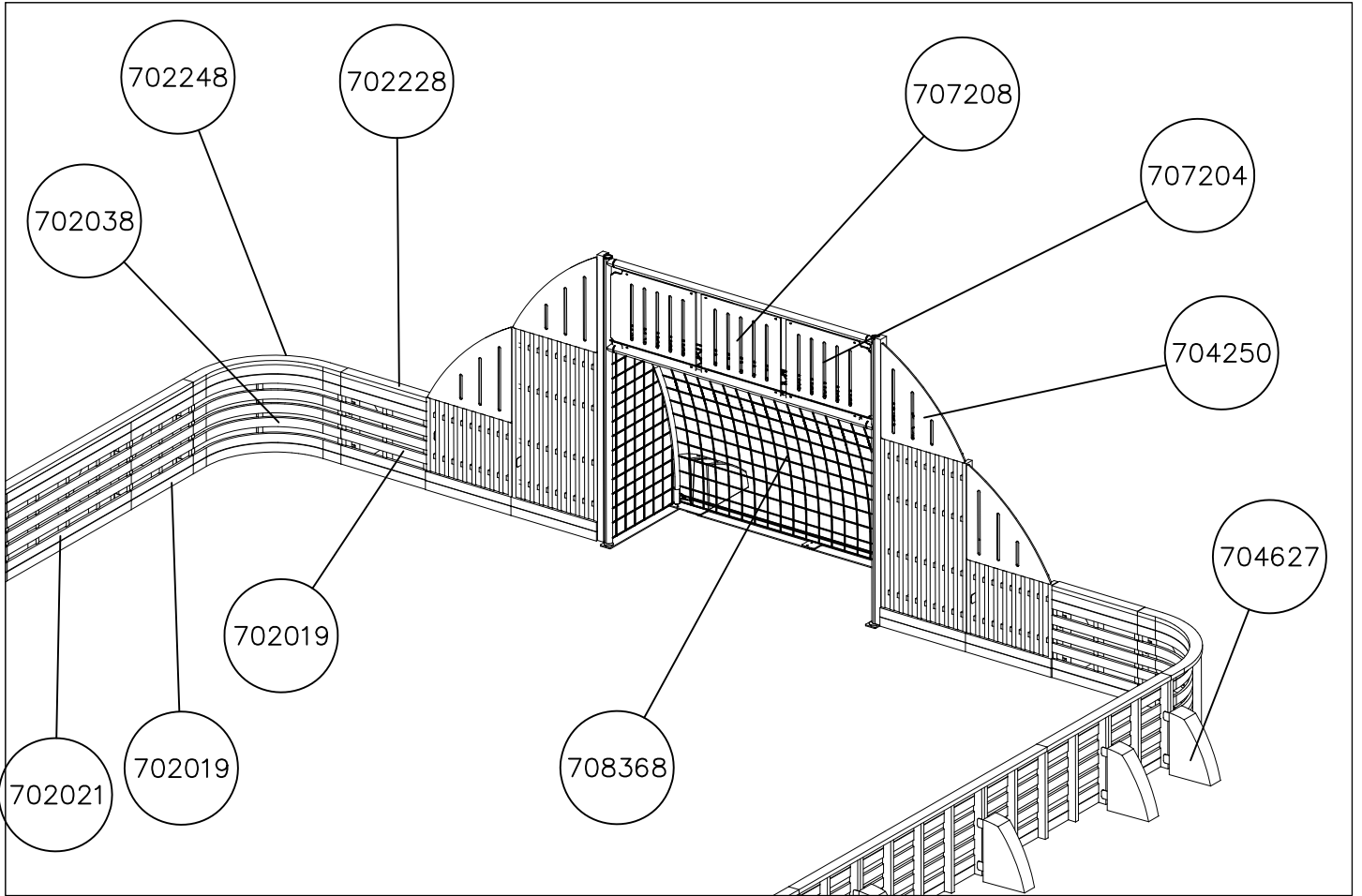

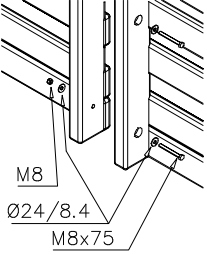
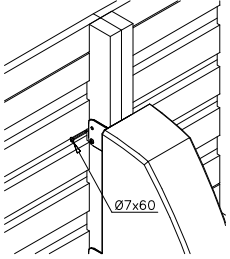
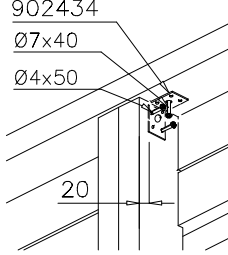
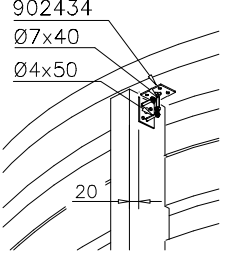

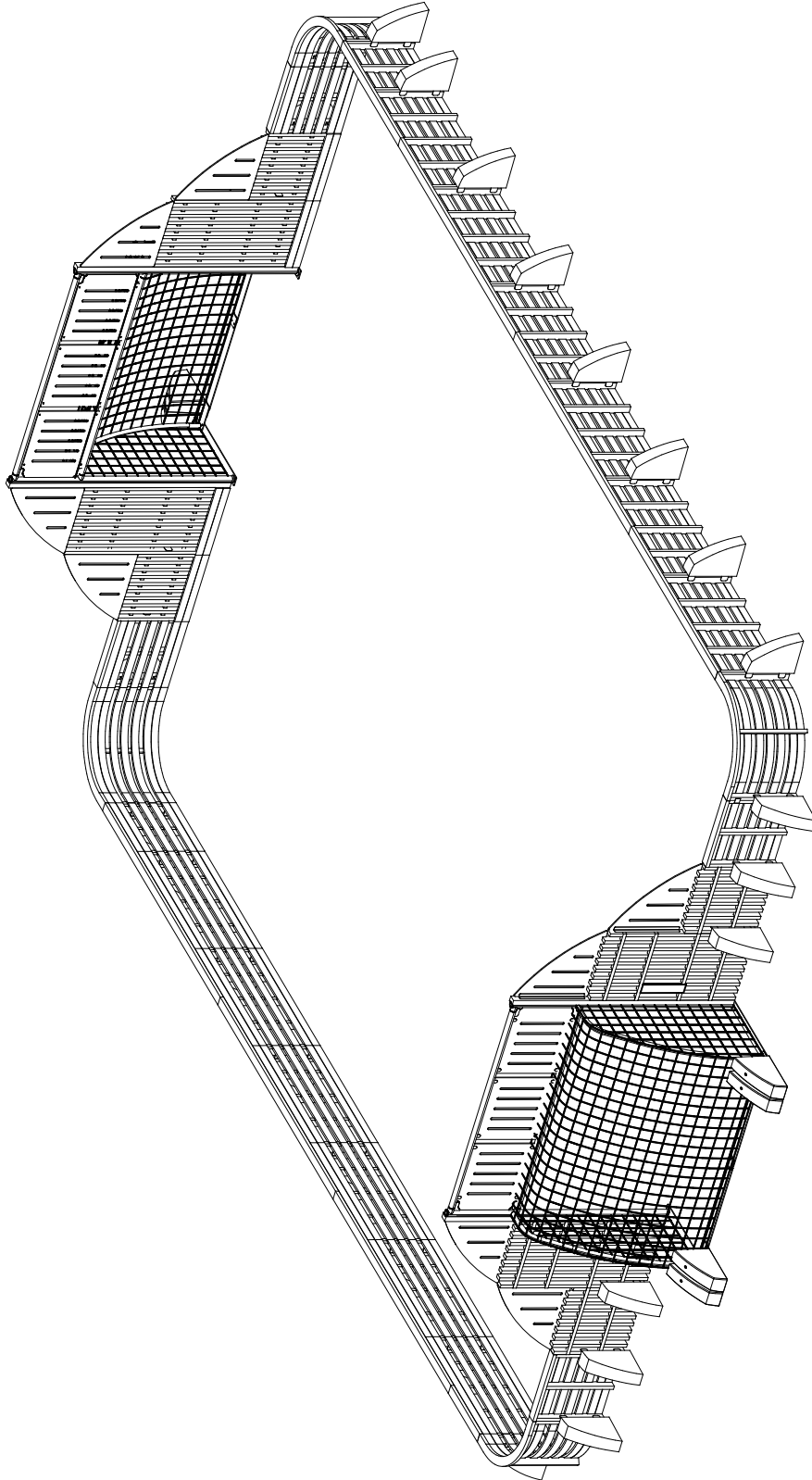

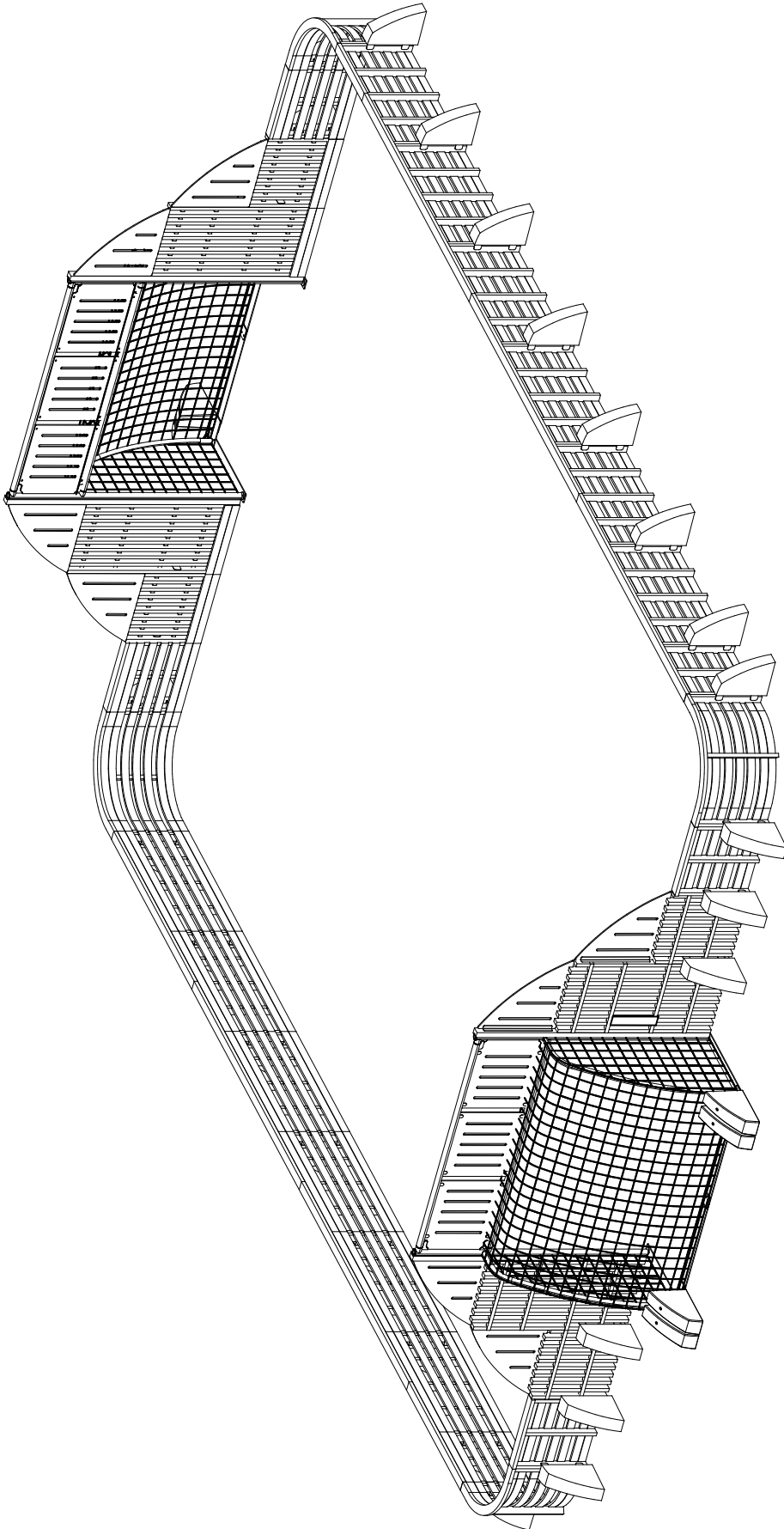
<p>DET 1</p> 	<p>DET 2</p> 	<p>DET 3</p> 	<p>DET 4</p> 







1. Tarkista pakkalistan avulla, että olet saanut tarvitsemasi osat (s. 3).
2. Valitse ARENALLE paikka ottaen huomioon valmistajan mitat (s. 5).
 - 2.1 Valitse ARENALLE sopiva kentän pinta käyttötarkoituksen mukaan. Yleisimpiä alustamateriaaleja ovat mm. synteettinen nurmi, kivituhka ja öljysora. Kentän pinta tulee valmistaa ennen ARENAn pystyttämistä.
 - 2.2 Tee tarvittavat peruskaivannot (s. 4). Huomaa, että perustussyvyyyksiä on kolme (3) eri syvyyttä (500 mm, 600 mm ja 950 mm). Betonia suositellaan käytettävän päätytolppien (8 kpl) perustamisessa riippuen maaperän tiiveydestä.
3. Tornien pystytysohjeet esitetään sivuilla 6 – 8.
 - 3.1 Päätyjen kokoaminen: Valitse 4050 mm mittaiset tolpat (6840) torneihin ja kiinnitä seinäelementit (3712) tolppiin (DET 4, s.6). Näin saat neljä (4) samanlaista tornin sivua. Kiinnitä torninsivut toisiinsa puomeilla (5692) (DET 1, s.6) ja toiseen torniin poikittaiset tangot alas (909542) (DET 12, s.6).
 - 3.2 Päätyjen pystyttäminen: pystytetään tornielementit ja rakennetaan silta tornien välille.
 - 3.3 Silta: kiinnitä maassa puomeihin (5343) pystysäleet (5345) (DET 5, s.6). Nosta siltakaiteet kokonaisuena tornien väliin ja kiinnitä tolppiin (DET 8–9, s.6).
 - 3.4 Kiinnitä oleskelutason lattiaritilät (3892, 3896) (erillinen ohje 3880), rekkitangot (909542) (DET 11, s.6), seinäelementit (3711) erillisen ohjeen mukaan ja listat (5340+5346) (DET 6, s.6).
 - 3.5 Koripalloteline: kts. erillinen ohje pakkauksesta (3721).
 - 3.6 Maaliverkko: kts. erillinen ohje pakkauksesta (3720).
4. Korkeiden sivujen asennus: Huom! Helpoin asennusjärjestys on aina: tolppa → seinäelementit → seuraava tolppa.
 - 4.1 Palloseinäelementit (3714) (DET 4, s.6) kiinnitetään ensin tornien tolppiin.
 - 4.2 Kolmioseinät (3715–3718) ja tolpanhatut asennetaan viimeisenä.
5. Matalien sivujen asennus. Huom! Helpoin asennusjärjestys on aina: tolppa → seinäelementit → seuraava tolppa.
 - 5.1 Jatketaan järjestyksessä toiseen pätyyn asti.
 - 5.2 Kolmioseinät ja tolpanhatut voidaan asentaa viimeisenä.
6. Pakkauslistassa (s.3)  – merkittyjen osien ohjeet ja kiinnitystarvikkeet löydät erillisistä pakkauksista.
7. Noudata valmistajan ilmoittamia mitoituksia.
8. Viimeisellä sivulla (s. 8) esitetään koko ARENAN kokoonpano.
9. Tarkista, että ARENA on suorassa ja perustukseltaan tukeva. Täytä kaivannot, suorita tiivistys 200 mm täytön jälkeen.
10. Tee käyttöönottotarkistus ennen ARENAN käyttöönottoa pakkauksessa olevan pöytäkirjan mukaan. Pöytäkirja tulee dokumentoida. Muista, että pääsy kentälle tulee estää, kunnes paikka on turvallinen ja työkalut on viety pois.

1. Prüfen Sie bitte anhand der Packliste die Vollständigkeit der Lieferung (S. 3).
2. Berücksichtigen Sie bitte bei der Wahl des Standortes die empfohlenen Sicherheitsabstände. (Seite 5).
 - 2.1. Wählen Sie den Standort für ARENA entsprechend dem Gebrauch. Die gebräuchlichsten Oberflächen sind synthetischer Rasen, Gummi-Oberfläche oder Tarmac. Die Oberfläche muss vor der Installation von ARENA fertig sein.
 - 2.2. Planieren Sie den Untergrund und führen die erforderlichen Grundausschachtungen durch (Seite 4). Achtung! Drei verschiedene Tiefen bei den Grundausschachtungen (500mm, 600mm und 950 mm) Je nach der Bodendichte wird empfohlen die Pfosten zu betonieren (8 Stck.).
3. Die Aufstellung der Türme erfolgt gemäss den Hinweisen auf den Seiten 6–8.
 - 3.1. Zusammenstellung der Endteile: Wählen Sie die 4050mm langen Pfosten (6840) für die Türme und befestigen die Wandelemente (3712) an die Pfosten (DET 4, S. 6). So bekommen Sie vier (4) gleiche Turmseiten. Befestigen Sie die Turmseiten mit den Pfosten (5692) (DET 1, S.6.) aneinander und zum andern Turm die unteren Querbalken (909542) (DET 12, S. 6).
 - 3.2. Aufstellung der Endteile: die Turmelemente werden aufgestellt und mit den Brücken verbunden.
 - 3.3. Die Brücke: befestigen Sie am Boden die Balken (5343) mit den vertikalen Latten (5345) (DET 5, S.6). Befestigen Sie die ganzen Brückengeländer zwischen die Türme hinauf an die Pfosten (DET 8–9, S. 6).
 - 3.4. Befestigen Sie den oberen Gitterboden (3892,3896) (nach separater Anleitung 3880), Reckstangen (909542) (DET 11, S.6), Wandelemente (3711) nach sep. Anleitung und Listen (5340+5346).
 - 3.5. Korbballgestell: siehe separate Anleitung in der Verpackung (3721).
 - 3.6. Tornetz: siehe separate Anleitung in der Verpackung (3720).
4. Aufbau der hohen Wandelemente: ACHTUNG! Die einfachste Aufbaureihenfolge ist immer: Pfosten → Wandelemente → nächster Pfosten.
 - 4.1. Zuerst werden die Ballwandelemente (3741) (DET 4, S.6) an die Pfosten montiert.
 - 4.2. Die Dreieckwände (3715–3718) werden zuletzt montiert.
5. Montage der niedrigen Wänden.
ACHTUNG! Die einfachste Aufbaureihenfolge ist immer: Pfosten → Wandelemente → nächster Pfosten.
 - 5.1. In dieser Reihenfolge geht es weiter bis zum nächsten Endteil.
 - 5.2. Die Dreieckwände und Top Hats werden zuletzt montiert.
6. Die in der Packliste (Seite 3) mit dem Symbol –  markierten Teile und Befestigungsmaterialien, finden Sie in separater Verpackung.
7. Befolgen Sie bitte die Maßangaben der Anleitung des Herstellers.
8. Auf der letzten Seite (S. 8) ist die Montage des ganzen Gerätes beschrieben.
9. Überprüfen Sie den waagrechten und senkrechten Stand des Gerätes. Füllen Sie die Löcher um die Pfosten auf und verdichten Sie diese.
10. Führen Sie vor der Inbetriebnahme des Gerätes die Gebrauchsabnahmeprüfung nach dem Protokoll durch, das der Packung beigelegt ist. Das Protokoll sollte dokumentiert werden. Beachten Sie im eigenen Interesse, da der Spielplatz erst dann in Betrieb genommen werden kann, wenn alle Gefahrenpunkte beseitigt und alle Arbeitsgeräte entfernt worden sind.



1. Kolla med hjälp av följesedeln att du erhållit önskade komponenter (s.3).
2. Välj plats för ARENA beaktande säkerhetsavstånden som tillverkaren angivit (s. 5).
 - 2.1 Välj underlag för ARENA beroende på användning. De vanligaste underlagen är konstgjort gräs, gummibeläggning eller asfalt. Ytan iordningställes innan montering av ARENA.
 - 2.2 Gör erforderlig utgrävning (s. 4) OBS! Tre olika monteringsdjup (500 mm, 600 mm och 950 mm). Slutstolpar (8 st) kan behöva gjutas beroende på markens densitet.
3. Montering av tornen visas på sidorna 6–8.
 - 3.1 Montering av slutenheter: Välj stolplängd 4050 mm (6840) för tornen och fäst väggelementen (3712) till stolparna (det 4, s. 6). Fäst även motsatta sidan stolpar (6840). Upprepa för samtliga (4) torn. Fäst tvärbommarna (5692) (det 1, s. 6) till tornen och montera stag (909542) (det 12, s.6).
 - 3.2 Installera slutenheten: placera tornen och fäst bron emellan dem.
 - 3.3 Broelementet: fäst de vertikala ribborna (5345) till de långa balkarna (5343) (det 5, s. 6) när de ligger på mark. Lyft upp handledarna mellan tornen och fäst till stolparna (det 8–9, s.6).
 - 3.4 Montera de övre golvelementen (3892, 3896) (separat monteringsanvisning 3880), stänger (909542 (det 11, s. 6), väggelement (3711) enligt separata anvisningar och ribbor (5340 + 5346) (det 6, s.6).
 - 3.5 Basketkorg: se separat anvisning i förpackning (3721).
 - 3.6 Nät: se separat anvisning i förpackning (3720).
4. Montering av de höga väggelementen: OBS! Den lättaste monteringsordningen är alltid: stolpe → väggelement → nästa stolpe.
 - 4.1 Fäst bollväggselementen (3714) (det 4, s.6) till tornens stolpar.
 - 4.2 Triangulära väggar (3715–3718) och stolphattar kan monteras sist.
5. Montering av långsidorna. OBS! Den lättaste monteringsordningen är alltid: stolpe → väggelement → nästa stolpe.
 - 5.1 Fortsätt till motsatta änden.
 - 5.2 Triangulära väggar (3715–3718) och stolphattar kan monteras sist.
6. Anvisningar och beslag till komponenter är listade i packlista (s. 3) och är markerade med symbolen –  .
7. Följ måttsättningen angiven av tillverkaren.
8. Den kompletta monterade anläggningen visas på sista sidan (s. 8).
9. Kolla att redskapet står rakt och att fundamentet är stadigt. Fyll groparna som grävts och packa till efter att du fyllt med 200 mm.
10. Utför besiktning innan redskapet tas i bruk enligt protokoll som medföljer leveransen. Protokollet bör dokumenteras. Glöm ej att hindra tillträde till lekplatsen till dess att lekplatsen är helt klar och trygg och att alla verktyg förts bort.

1. Utilisez la liste des composants pour vérifier qu'aucun d'eux ne manque (p. 3).
2. Choisissez l'orientation d'ARENA en fonction des exigences de sécurité requises pour l'emplacement, communiquées par le fabricant (p. 5).
 - 2.1 Choisissez un revêtement de sol adapté à l'usage d'ARENA. Les revêtements les plus courants sont : pelouse synthétique, surface en caoutchouc ou tarmac. Il est nécessaire de préparer la surface du terrain avant l'installation d'ARENA.
 - 2.2 Creusez les fondations nécessaires (p. 4). Notez qu'il y a trois (3) profondeurs différentes pour les fondations (500 mm, 600 mm et 950 mm). Si la densité du sous-sol est insuffisante, il est recommandé d'utiliser du béton (sable 2-6 mm) pour les fondations des piliers (8 pièces) des deux extrémités.
3. Les instructions pour le montage des tours figurent sur les pages 6 - 8.
 - 3.1 Assemblage des éléments d'extrémité : Utilisez les piliers de 4050 mm (6840) pour les tours et fixez-y les éléments muraux (3712) (DET 4, p. 6). Préparez ainsi quatre (4) éléments murailles identiques pour les tours. Fixez les éléments des tours deux à deux avec les solives (5692) (DET 1, p. 6) et entre deux tours, en bas, les barres transversales (909542) (DET 12, p. 6).
 - 3.2 Installation des extrémités : installez les tours et construisez entre elles le pont.
 - 3.3 Pont : Au sol, fixez sur les barres (5343) les lattes verticales (5345) (DET 5, p. 6). Montez les rampes du pont entre les tours et fixez-les sur les piliers (DET 8-9, p. 6).
 - 3.4 Fixez les grilles de plancher (3892, 3896) du niveau supérieur (instructions séparées 3880), les barres transversales (909542) (DET 11, p. 6), les éléments muraux (3711) comme indiqué dans les instructions séparées, et les lattes (5340 + 5346) (DET 6, p. 6).
 - 3.5 Panneau de basket : voir les instructions séparées dans le colis (3721).
 - 3.6 Filet de but : voir les instructions séparées dans le colis (3720).
4. Assemblage des éléments des murs hauts :
NOTE ! L'assemblage le plus facile se fait toujours dans l'ordre : poteau -> élément de mur -> poteau suivant -> etc.
 - 4.1 Fixez les éléments muraux pour les jeux de ballon (3714) (DET 4, p.6) d'abord aux piliers des tours.
 - 4.2 Les éléments de murs triangulaires (3715 - 3718) et les chapeaux de poteaux peuvent être fixés en dernier.
5. Assemblage des côtés bas.
NOTE ! L'assemblage le plus facile se fait toujours dans l'ordre : poteau -> élément de mur -> poteau suivant -> etc.
 - 5.1 Continuez ainsi jusqu'à l'autre extrémité.
 - 5.2 Les éléments de murs triangulaires et les chapeaux de poteaux peuvent être fixés en dernier.
6. Dans la liste des composants (p. 3), le symbole  indique que les instructions et le matériel de fixation se trouvent dans un colis séparé.
7. Conformez-vous aux dimensions indiquées par le fabricant.
8. Sur la dernière page (p. 8) figure l'assemblage complet d'ARENA.
9. Vérifiez que l'unité est correctement alignée, et les fondations stables et solides. Remplissez les trous et compacter la terre de 200 mm.
10. Procédez à une vérification finale de l'unité ARENA en utilisant la fiche d'inspection contenue dans le colis. Conservez ce document une fois rempli. N'oubliez pas que l'accès ne doit pas être autorisé avant que l'unité complète soit entièrement montée et sécurisée, et que toute la zone soit débarrassée des outils.

1. Use the packing list to check that none of the required components are missing (p. 3).
2. Select the orientation for ARENA according to the safety area requirements informed by producer (p. 5).
 - 2.1 Choose the ground surface for ARENA according the usage. The most common ground surfaces are synthetic grass, rubber surface or tarmac. The ground surfaces have to be produced before installing the ARENA.
 - 2.2 Make the necessary excavation (p. 4). Note! Three (3) different depths for ground works (500 mm, 600 mm and 950 mm). Recommended to use concrete in end unit post ground works (8 pcs) depending on earth density.
3. The instructions for the erection of the towers are shown on page 6–8.
 - 3.1 Assembling of end units: Choose the post lengths 4050 mm (6840) to towers and fasten the wall elements (3712) to posts (DET 4, p.6). Fasten also on the other side the post (6840). Continue with this process for (4) same kind of tower elements. Fasten the cross beams (5692) (DET 1, p.6) to tower elements and to the other tower the cross bars (909542) (DET 12, s.6) below.
 - 3.2 Installing the end units: install the tower elements and build the bridge between.
 - 3.3 The bridge: fasten to long beams (5343) the vertical slats (5345) (DET 5, p.6) in ground. Lift up the handrails between the towers and fasten to the posts (DET 8–9, p.6).
 - 3.4 Fasten the upper level floor grates (3892, 3896) (separate instructions 3880), bars (909542) (DET 11, p.6), wall elements (3711) according to the separate instructions and slats (5340 + 5346) (DET 6, p.6).
 - 3.5 Basket ball rack: see separate instructions in package (3721).
 - 3.6 Goal net: see separate instructions in package (3720).
4. Assembling the high wall elements: NOTE! The easiest mounting order is always: post → wall elements → next post.
 - 4.1 Fasten the ball wall elements (3714) (DET 4, p.6) first to the posts of towers.
 - 4.2 Triangle walls (3715–3718) and top hats can be fastened last.
5. Assembling the lower sides. NOTE! The easiest mounting order is always: post → wall elements → next post.
 - 5.1 Continue in order to the other end.
 - 5.2 Triangle walls (3715–3718) and top hats can be fastened last.
6. You will find the instructions and fixings for the components listed in packing list (p.3) and marked with symbol –  in separate packages.
7. Comply with the dimensions indicated by the manufacturer.
8. The assembly of the complete unit is shown on the last page (p.8).
9. Check that the unit is correctly aligned and firmly supported. Fill in the excavations and compact the earth at 200 mm.
10. Carry out an acceptance inspection of the playground unit using the inspection form contained in the package. File the form once completed. Remember that no access to the playground unit must be allowed until installation is completed and safe and the area is cleared of all tools.

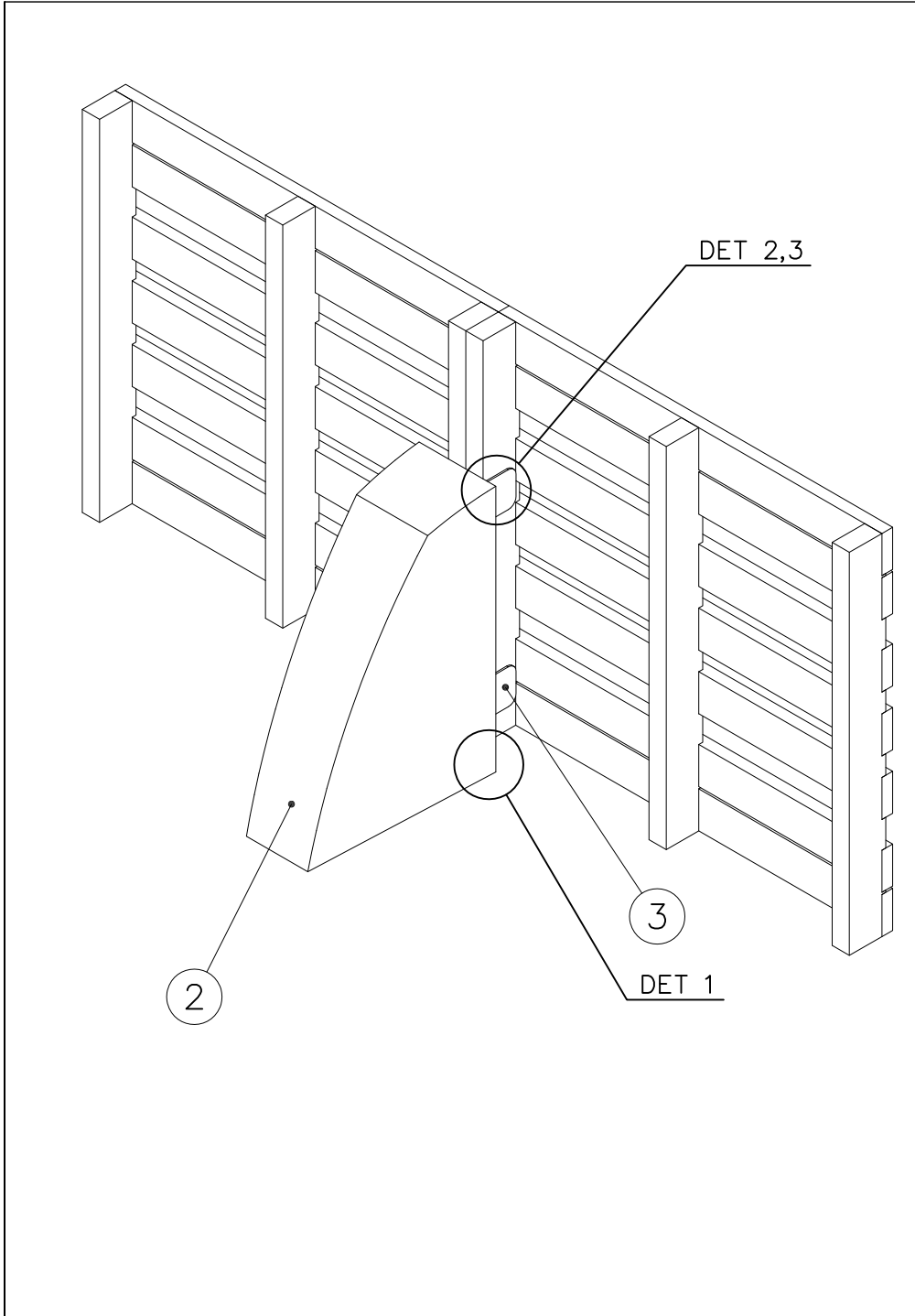
1. Verificar con la lista del remito que se han recibido todas las partes necesarias.
2. Seleccionar el lugar de instalación de ARENA, teniendo en cuenta las dimensiones de fábrica (pg. 5).
 - 2.1 Seleccionar una superficie de instalación adecuada según el uso del modelo ARENA. Los materiales de base más comunes son, por ejemplo, hierba sintética, superficies de caucho y macadam alquitranado. La superficie debe estar lista antes de instalar el modelo ARENA.
 - 2.2 Realizar todas las excavaciones básicas necesarias (pg. 4). NOTA: hay tres profundidades básicas (500 mm, 600 mm y 950 mm). Se recomienda emplear hormigón en la cimentación de los postes de las torres (8 unidades), dependiendo de lo compacto del terreno.
3. Las instrucciones de elevación de las torres se presentan en las páginas 6 a 8.
 - 3.1 Montaje de las torres: Elegir postes de 4050 mm (6840) para las torres y fijar los elementos de tabique (3712) a los postes (DET 4, pg. 6). Hacer de esta manera cuatro (4) lados de torre iguales. Fijar los lados de torre entre sí con vigas (5692) (DET 1, pg. 6) y a la otra torre con las barras transversales abajo (909542) (DET 12, pg. 6).
 - 3.2 Montaje de las torres: erguir los elementos de torre y construir un puente entre las torres.
 - 3.3 Puente: fijar en el suelo las tablillas verticales (5345) a las vigas (5343) (DET 5, pg. 6). Levantar las barandillas del puente entre las torres y fijarlas a los pilares (DET 8–9, pg. 6).
 - 3.4 Fijar las rejillas de piso del nivel de estar (3892, 3896) (instrucción separada 3880), las barras (909542) (DET 11, pg. 6), los elementos de tabique (3711) según la instrucción separada y las tablillas (5340 + 5346) (DET 6, pg. 6).
 - 3.5 Soporte de basquetbol: ver instrucción separada en el embalaje (3721).
 - 3.6 Red de la portería: ver instrucción separada en el embalaje (3720).
4. Instalación de los lados altos: NOTA: el orden de instalación más fácil siempre es: poste → elementos de tabique → poste siguiente.
 - 4.1 Los elementos de tabiques de peloteo (3714) (DET 4, pg. 6) se fijan primero a los pilares de las torres.
 - 4.2 Los tabiques triangulares (3715–3718) y los sombreretes de los postes son lo último en instalarse.
5. Instalación de los lados bajos. NOTA: el orden de instalación más fácil siempre es: poste → elementos de tabique → poste siguiente.
 - 5.1 Continuar en orden hasta el otro extremo.
 - 5.2 Los tabiques triangulares y los sombreretes de los postes pueden instalarse al final.
6. Las instrucciones y los elementos de fijación de partes marcados con  en la lista del remito (pg. 3) se encuentran en distintos embalajes.
7. Seguir las dimensiones dadas por el fabricante.
8. En la última página (pg. 8) se presenta todo el montaje de ARENA.
9. Verificar que ARENA esté correctamente alineada y firmemente cimentada. Llenar las excavaciones, compactar después de un relleno de 200 mm.
10. Realizar la revisión de puesta en servicio de ARENA antes de comenzar su uso, según el formulario incluido en el embalaje. El formulario debe documentarse. Recordar que debe impedirse el acceso al área de juego hasta que el lugar sea seguro y se hayan retirado las herramientas.

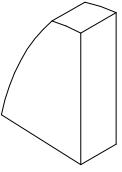
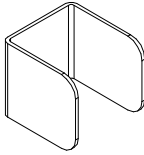

① 900367	PCS	② 904862	PCS
	4		1
M12x40		200x468x600	
③ 904863	PCS	④ 980123	PCS
	2		8
90x98x104		Ø7x60	
⑤ 980165	PCS		PCS
	4		
Ø26/13			
	PCS		PCS
	PCS		PCS
	PCS		PCS

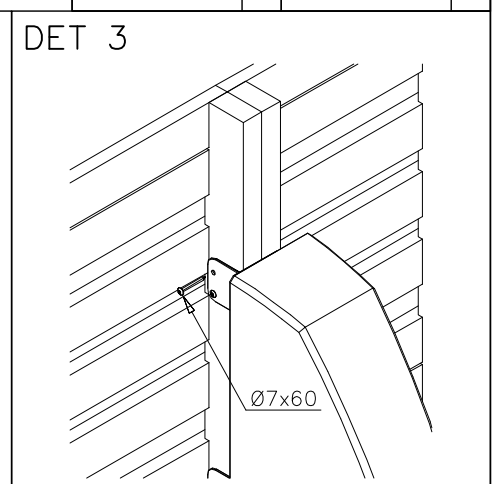
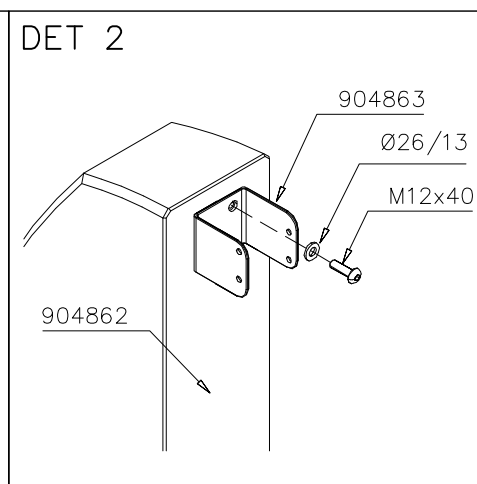
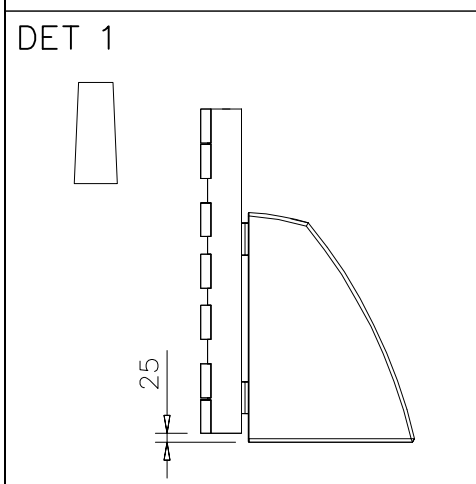

DET 1

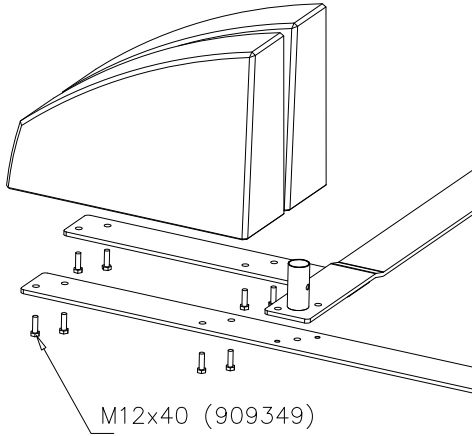

DET 2

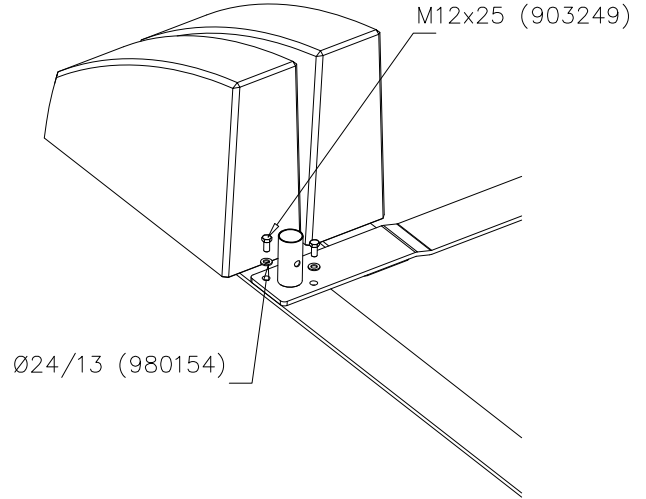



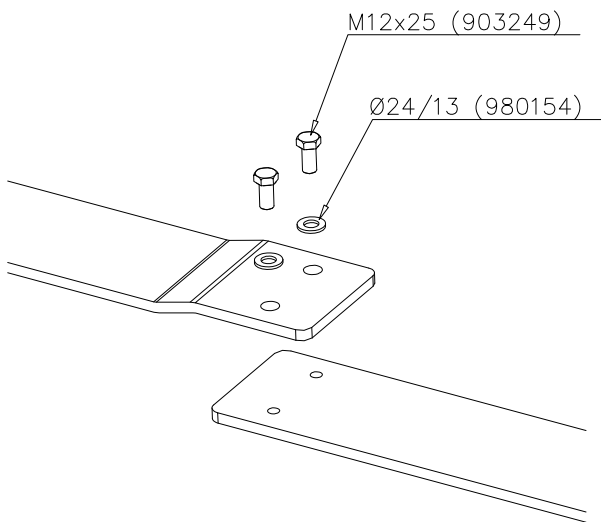



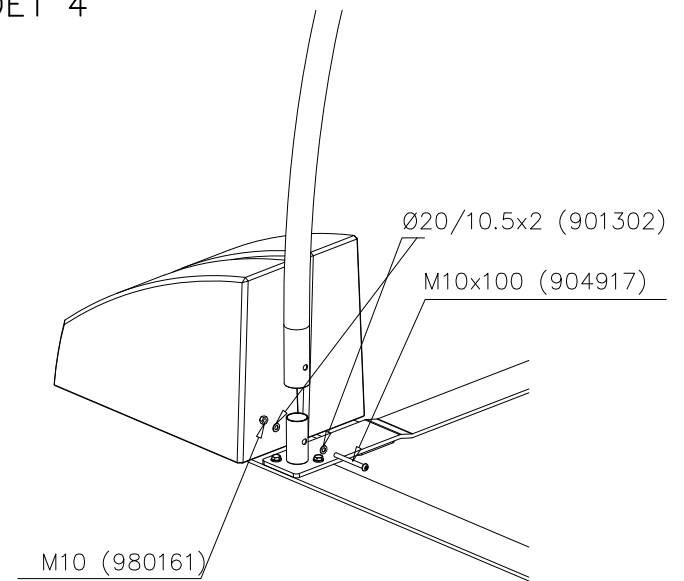

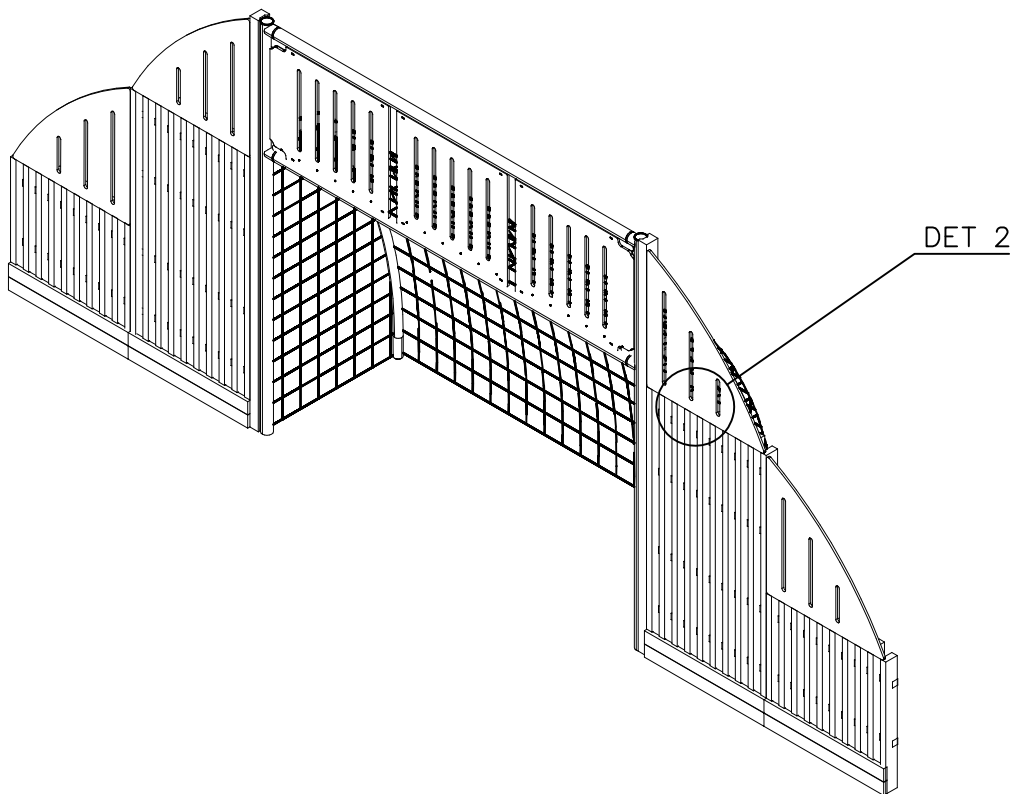
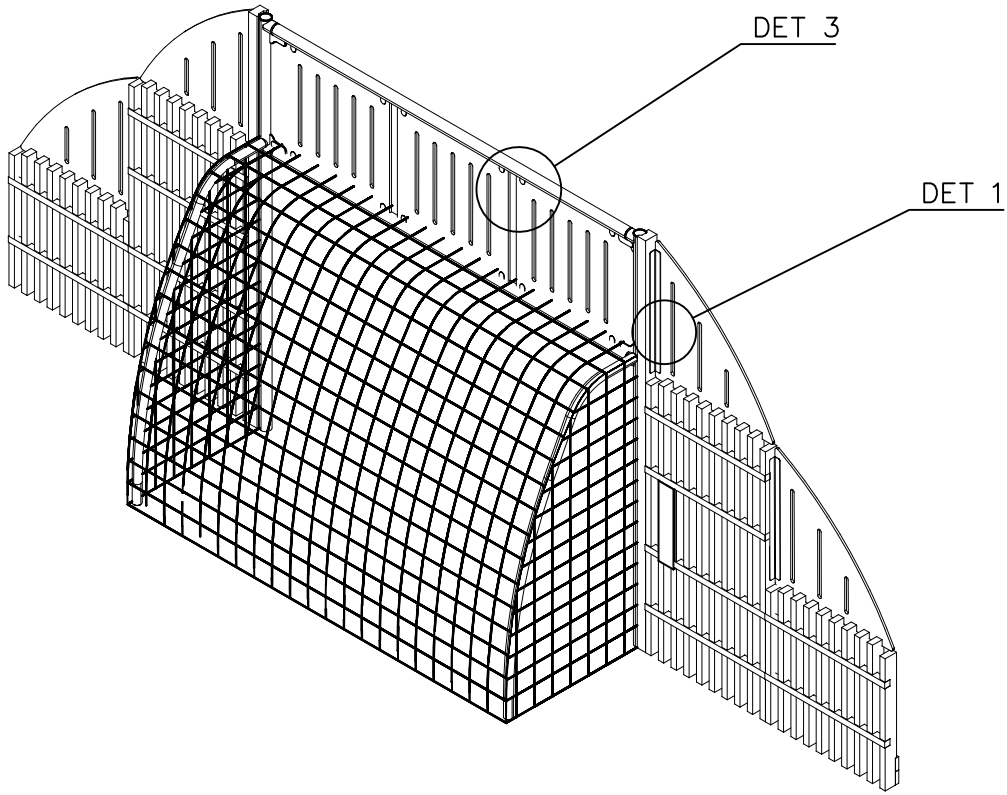

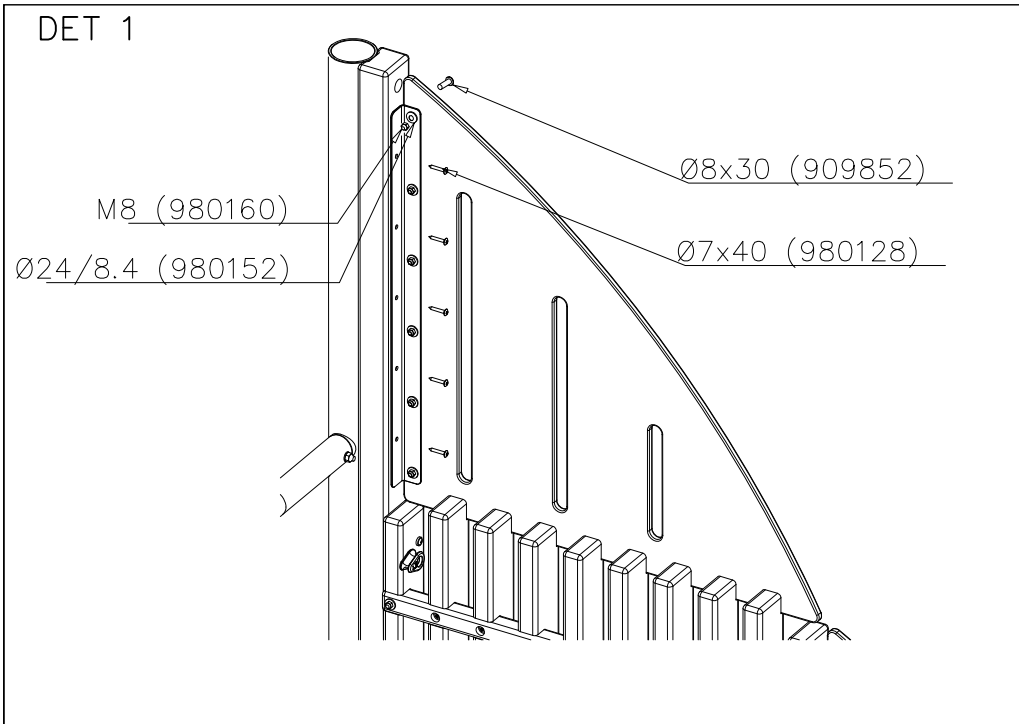





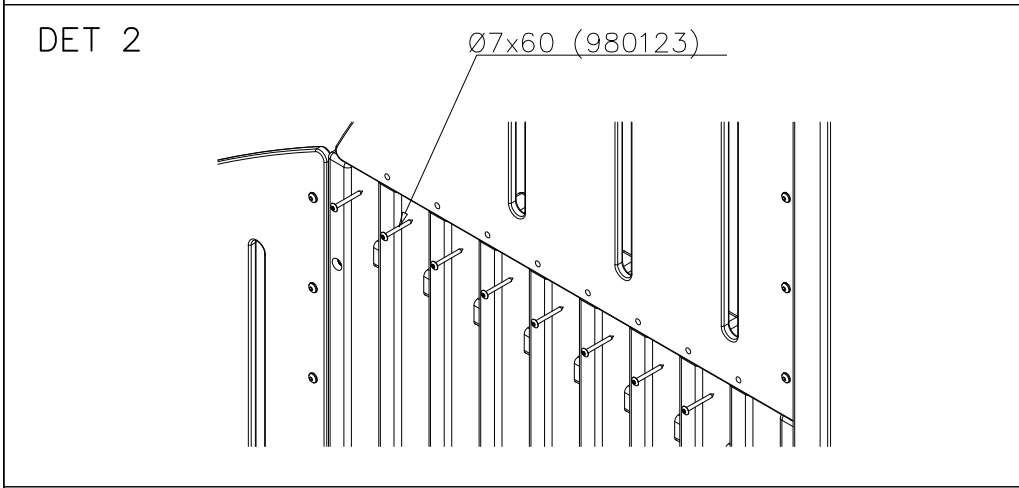













DET 3



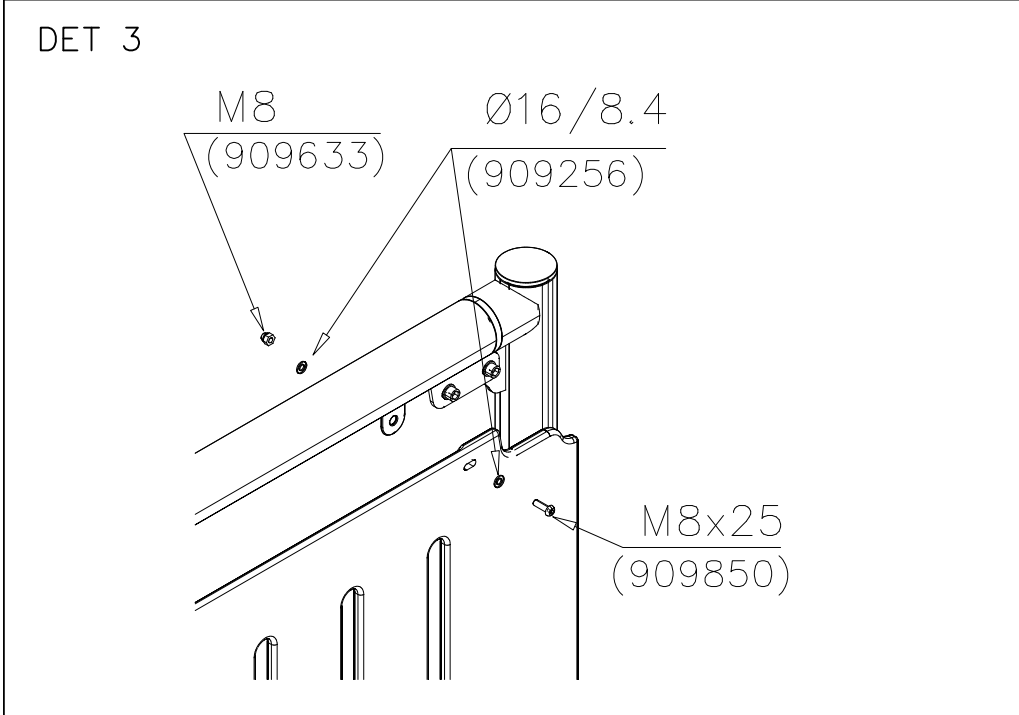
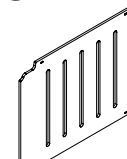
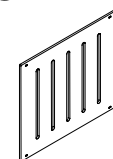

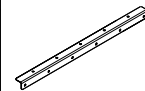
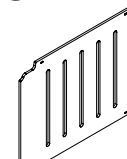
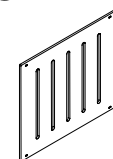

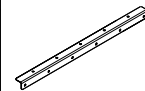
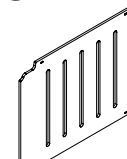
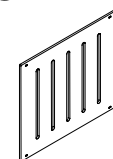
DET 4

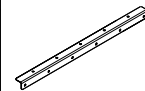

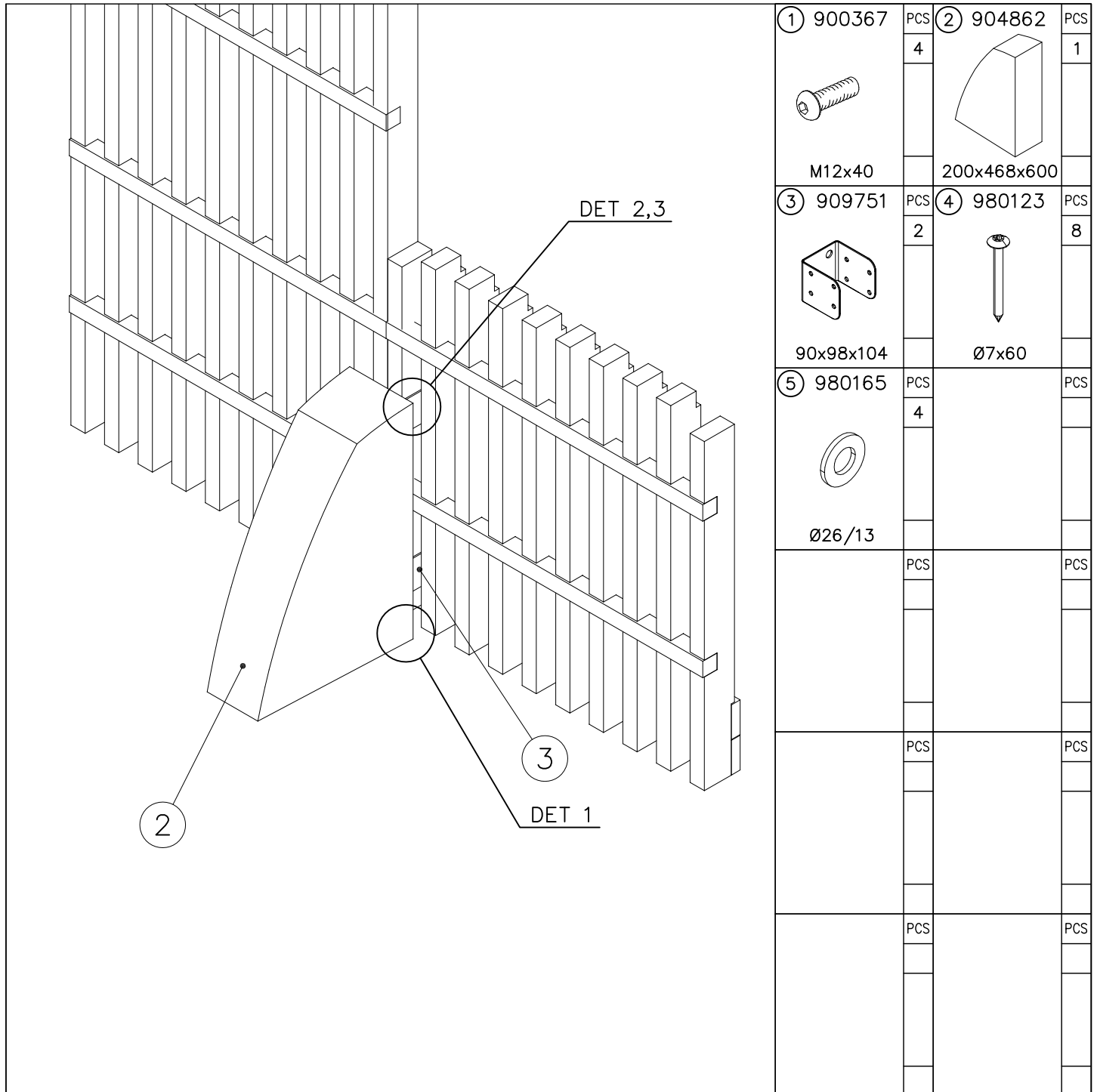

<p>DET 1</p> 	<table border="1"> <tr> <td>① 909850</td> <td>PCS</td> <td>② 909633</td> <td>PCS</td> </tr> <tr> <td></td> <td>12</td> <td></td> <td>12</td> </tr> <tr> <td>M8x25</td> <td></td> <td>M8</td> <td></td> </tr> </table>	① 909850	PCS	② 909633	PCS		12		12	M8x25		M8																													
① 909850	PCS	② 909633	PCS																																						
	12		12																																						
M8x25		M8																																							
<p>DET 2</p> 	<table border="1"> <tr> <td>③ 909256</td> <td>PCS</td> <td>④ 980123</td> <td>PCS</td> </tr> <tr> <td></td> <td>24</td> <td></td> <td>32</td> </tr> <tr> <td>Ø16/8.4x1.6</td> <td></td> <td>Ø7x60</td> <td></td> </tr> <tr> <td>⑤ 980128</td> <td>PCS</td> <td>⑥ 980160</td> <td>PCS</td> </tr> <tr> <td></td> <td>20</td> <td></td> <td>24</td> </tr> <tr> <td>Ø7x40</td> <td></td> <td>M8</td> <td></td> </tr> <tr> <td>⑦ 980152</td> <td>PCS</td> <td>⑧ 909852</td> <td>PCS</td> </tr> <tr> <td></td> <td>24</td> <td></td> <td>24</td> </tr> <tr> <td>Ø24/8.4x2</td> <td></td> <td>M8x30</td> <td></td> </tr> <tr> <td></td> <td>PCS</td> <td></td> <td>PCS</td> </tr> </table>	③ 909256	PCS	④ 980123	PCS		24		32	Ø16/8.4x1.6		Ø7x60		⑤ 980128	PCS	⑥ 980160	PCS		20		24	Ø7x40		M8		⑦ 980152	PCS	⑧ 909852	PCS		24		24	Ø24/8.4x2		M8x30			PCS		PCS
③ 909256	PCS	④ 980123	PCS																																						
	24		32																																						
Ø16/8.4x1.6		Ø7x60																																							
⑤ 980128	PCS	⑥ 980160	PCS																																						
	20		24																																						
Ø7x40		M8																																							
⑦ 980152	PCS	⑧ 909852	PCS																																						
	24		24																																						
Ø24/8.4x2		M8x30																																							
	PCS		PCS																																						
<p>DET 3</p> 	<table border="1"> <tr> <td colspan="4">NOT INCLUDED</td> </tr> <tr> <td>○ 707204</td> <td>PCS</td> <td>○ 707208</td> <td>PCS</td> </tr> <tr> <td></td> <td>2</td> <td></td> <td>1</td> </tr> <tr> <td>15x814x992</td> <td></td> <td>15x814x925</td> <td></td> </tr> <tr> <td>○ 704250</td> <td>PCS</td> <td>○ 904900</td> <td>PCS</td> </tr> <tr> <td></td> <td>4</td> <td></td> <td>4</td> </tr> <tr> <td>990x980x15</td> <td></td> <td>45x45x3x875</td> <td></td> </tr> </table>	NOT INCLUDED				○ 707204	PCS	○ 707208	PCS		2		1	15x814x992		15x814x925		○ 704250	PCS	○ 904900	PCS		4		4	990x980x15		45x45x3x875													
NOT INCLUDED																																									
○ 707204	PCS	○ 707208	PCS																																						
	2		1																																						
15x814x992		15x814x925																																							
○ 704250	PCS	○ 904900	PCS																																						
	4		4																																						
990x980x15		45x45x3x875																																							

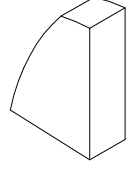
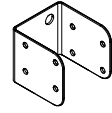
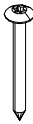

① 900367  M12x40	PCS 4	② 904862  200x468x600	PCS 1
③ 909751  90x98x104	PCS 2	④ 980123  Ø7x60	PCS 8
⑤ 980165  Ø26/13	PCS 4		PCS
	PCS		PCS
	PCS		PCS
	PCS		PCS

DET 1

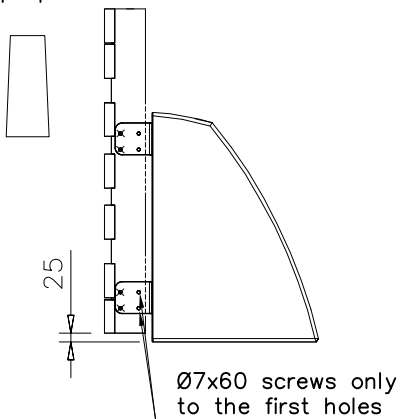

DET 2

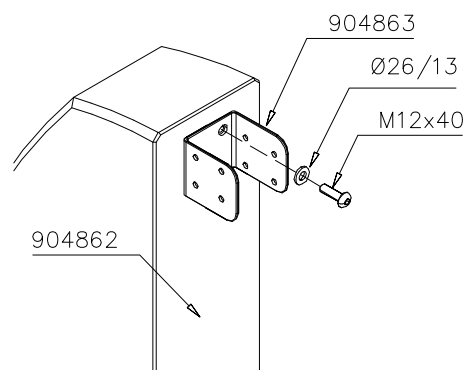

DET 3

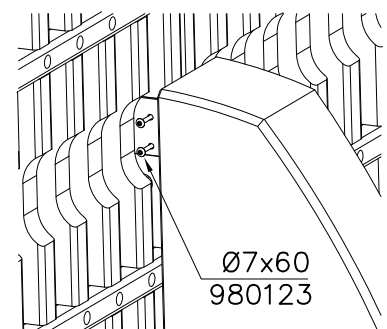

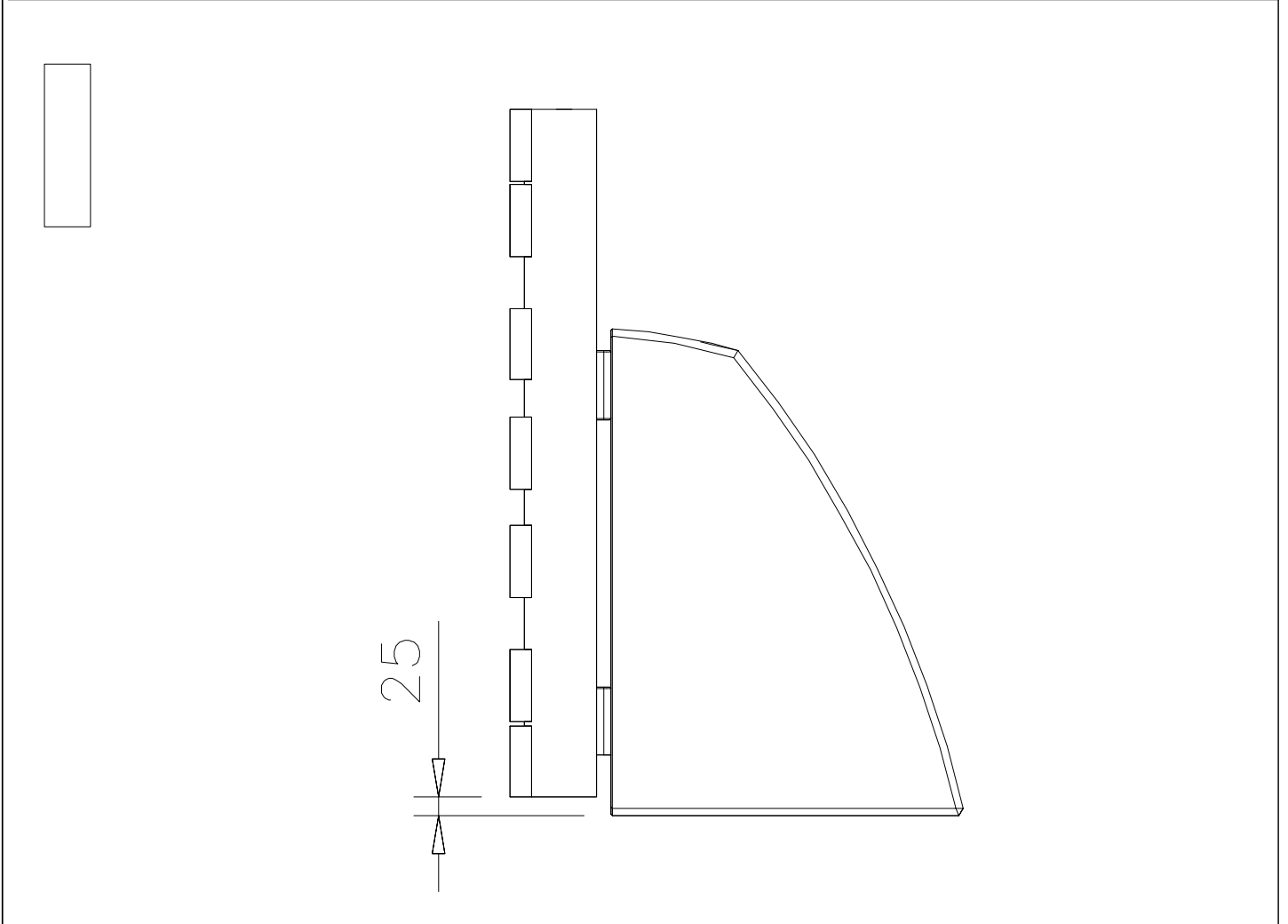
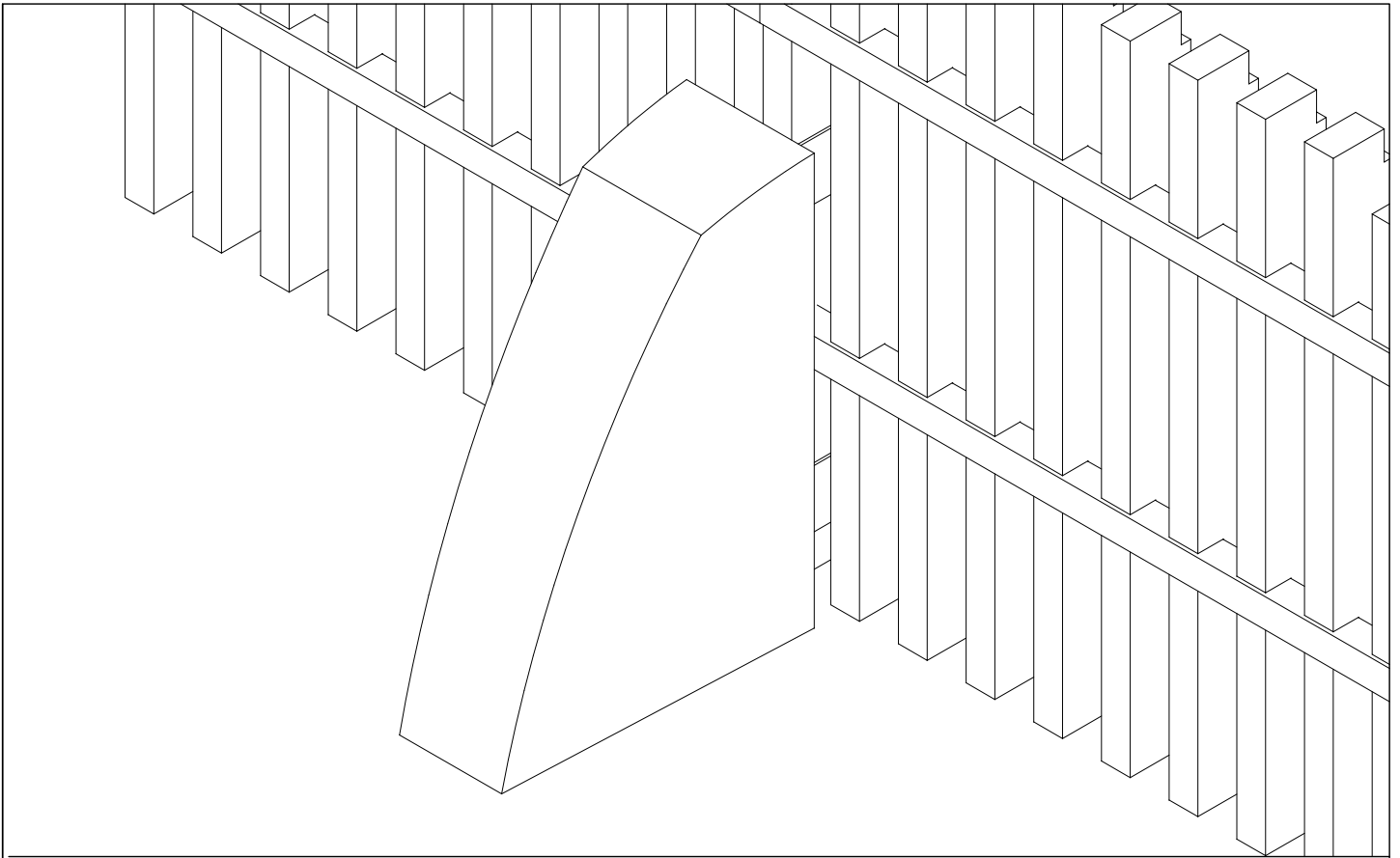

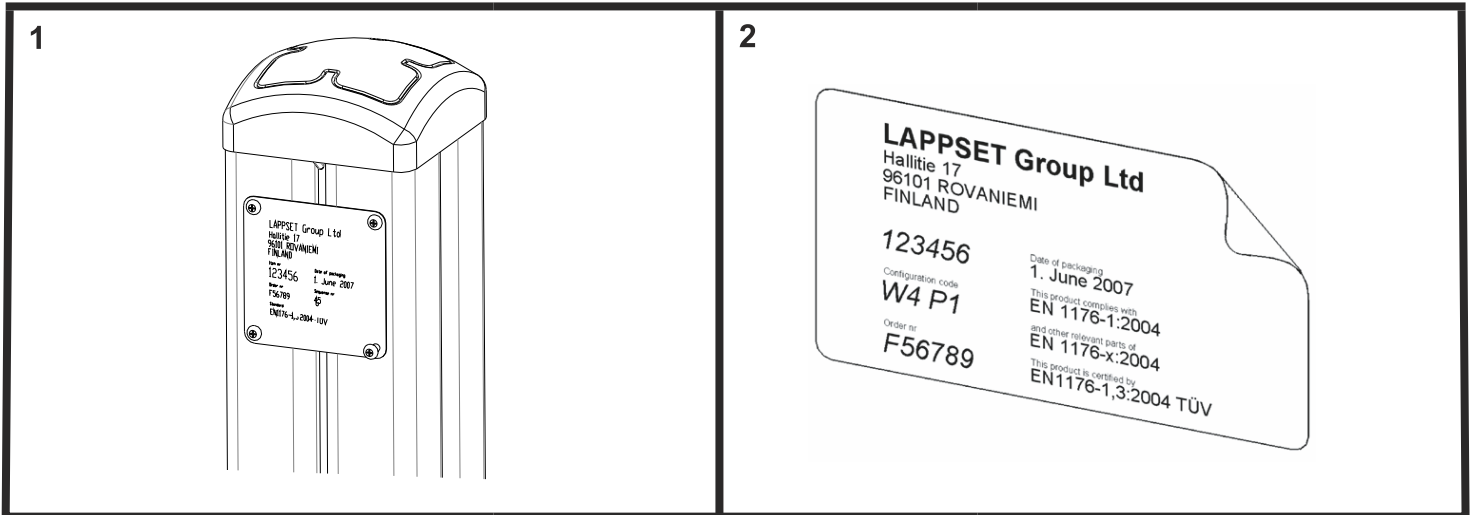
**Tuotekyltti tulee tuotteen mukana yhdellä seuraavista tavoista:****1) Metallinen tuotekyltti ja kiinnitysruuvit**

- Kiinnitä tuotekyltti ruuveilla tolppaan noin 2 metrin korkeuteen kuvan 1 mukaisesti.

2) Tuotekylttitarra

- Puhdista maalattu metalli- tai vaneripinta pölystä ja kosteudesta. Liimaa tarra kuvan 2 mukaisesti.
- Huom. Älä kiinnitä tarraa karheapintaiseen laminaattiin tai maalattuun puuhun.

Vår produktmärkning levereras på ett av följande sätt:**1) Produktskylt i metall**

- Fäst skylten med de medföljande skruvarna

2) Självhäftande produktetikett

- Rengör den pulverlackerade metallytan eller laminatyten så att den blir fri från smuts och fukt. Fäst etiketten enligt fig. 2.
- Obs! Fäst ej etiketten på detaljer med skrovlig yta eller på målat trä.

Product label is delivered by one of following ways:**1) Metal product label and screws**

- Fasten the label with screws.

2) Label sticker

- Clean the painted metal or plywood surface from dirt and moisture. Fasten the sticker as shown in the figure 2.
- Note. Do not attach the sticker to rough surfaced laminate or painted wood.

La plaque d'informations produit est livrée sous l'une de ces 3 formes :**1) Plaque métallique et vis**

- Fixez la plaque à l'aide des vis.

2) Etiquette autocollante

- Avant de coller l'étiquette, nettoyez le composant métallique peint ou la plaque de contreplaqué, de toute saleté. La surface doit être sèche (voir image 2).
- Attention, ne pas coller l'étiquette sur une surface lamellé-collée irrégulière ou sur du bois peint.

Die Auslieferung des Produktaufklebers erfolgt auf eine dieser Arten:**1) Produkt-Schild aus Metall incl. Schrauben**

- Die Befestigung des Schildes erfolgt mittels der Schrauben.

2) Aufkleber

- Entfernen Sie zunächst Schmutz und Feuchtigkeit vom lackierten Metall bzw. von der Holzoberfläche und bringen Sie den Aufkleber wie im Bild oben rechts beschrieben auf den gesäuberten Untergrund auf.
- Beachten Sie: Bringen Sie den Aufkleber nicht auf raues laminiertes oder lackiertes Holz an.