

LAPPSET®

FLORA







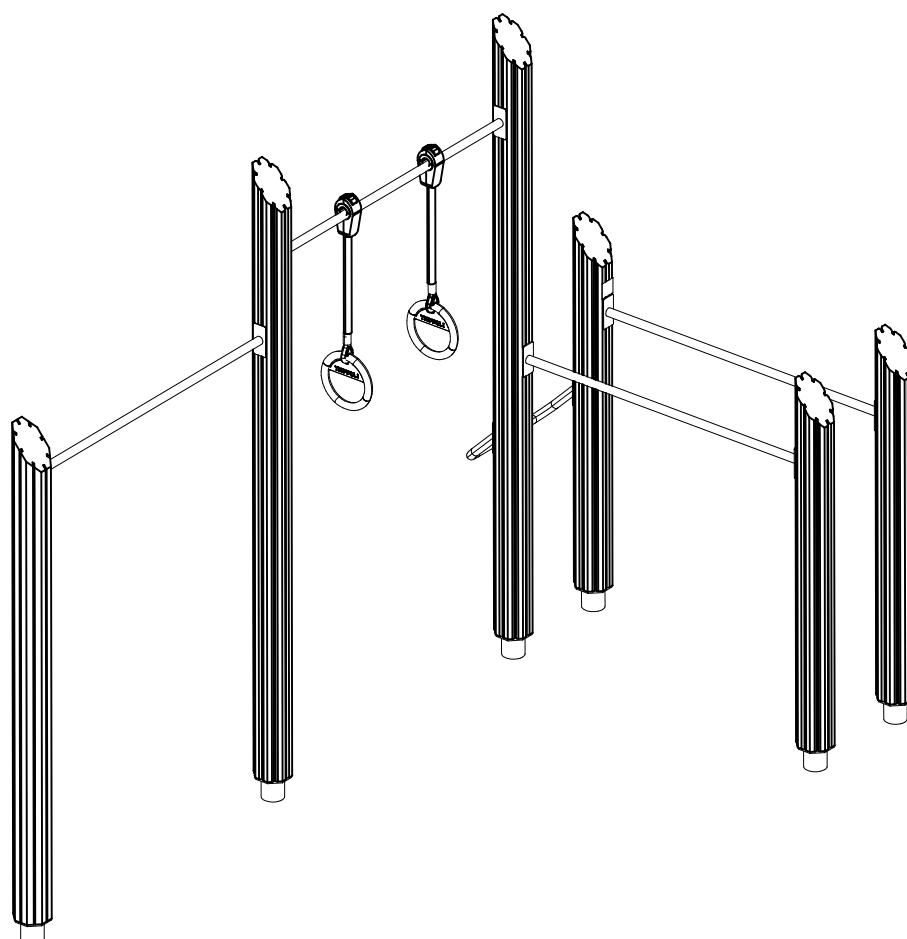

ASENNUSOHJE
MONTERINGSANSVISNING
INSTALLATION INSTRUCTION
AUFBAUANLEITUNG
NOTICE D'INSTALLATION

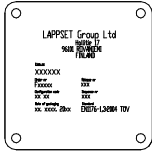
DATE: 17.6.2020

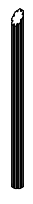
Q14362

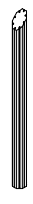
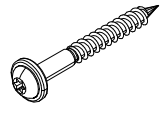
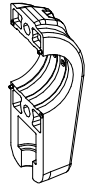
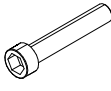

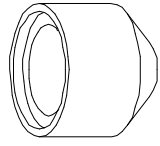
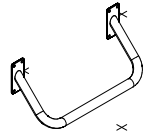
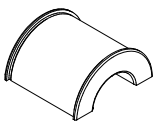
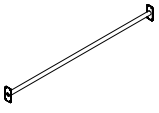
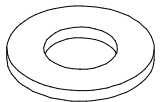
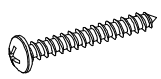
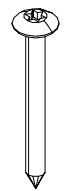
DATE: 17.6.2020

<p>702286</p>  <p>65x65</p>	<p>PCS</p> <p>1</p>	<p>705040</p>  <p>Ø16x764</p>	<p>PCS</p> <p>2</p>	<p>705379</p>  <p>l=2594</p>	<p>PCS</p> <p>2</p>	<p>705393</p>  <p>l=1550</p>	<p>PCS</p> <p>3</p>	<p>705811</p>  <p>l=2094</p>	<p>PCS</p> <p>1</p>	<p>900240</p>  <p>Ø8x70</p>	<p>PCS</p> <p>8</p>
<p>902195</p>  <p>150x50x50</p>	<p>PCS</p> <p>4</p>	<p>902232</p>  <p>M10x55</p>	<p>PCS</p> <p>2</p>	<p>902233</p>  <p>M10x30</p>	<p>PCS</p> <p>2</p>	<p>903112</p>  <p>l=750</p>	<p>PCS</p> <p>6</p>	<p>905104</p>  <p>M10</p>	<p>PCS</p> <p>48</p>	<p>905934-216</p> 	<p>PCS</p> <p>1</p>
<p>906006</p>  <p>Ø64/36,4x59</p>	<p>PCS</p> <p>4</p>	<p>908017-216</p>  <p>L 1315</p>	<p>PCS</p> <p>4</p>	<p>909256</p>  <p>Ø16/8.4</p>	<p>PCS</p> <p>32</p>	<p>980114</p>  <p>Ø4x20</p>	<p>PCS</p> <p>4</p>	<p>980123</p>  <p>Ø7x60</p>	<p>PCS</p> <p>32</p>	<p>980161</p>  <p>M10</p>	<p>PCS</p> <p>4</p>
	PCS		PCS		PCS		PCS		PCS		PCS
	PCS		PCS		PCS		PCS		PCS		PCS
	PCS		PCS		PCS		PCS		PCS		PCS
	PCS		PCS		PCS		PCS		PCS		PCS

—— EN/AS Impact Area 26 m²
---- Falling Space 25.9 m²

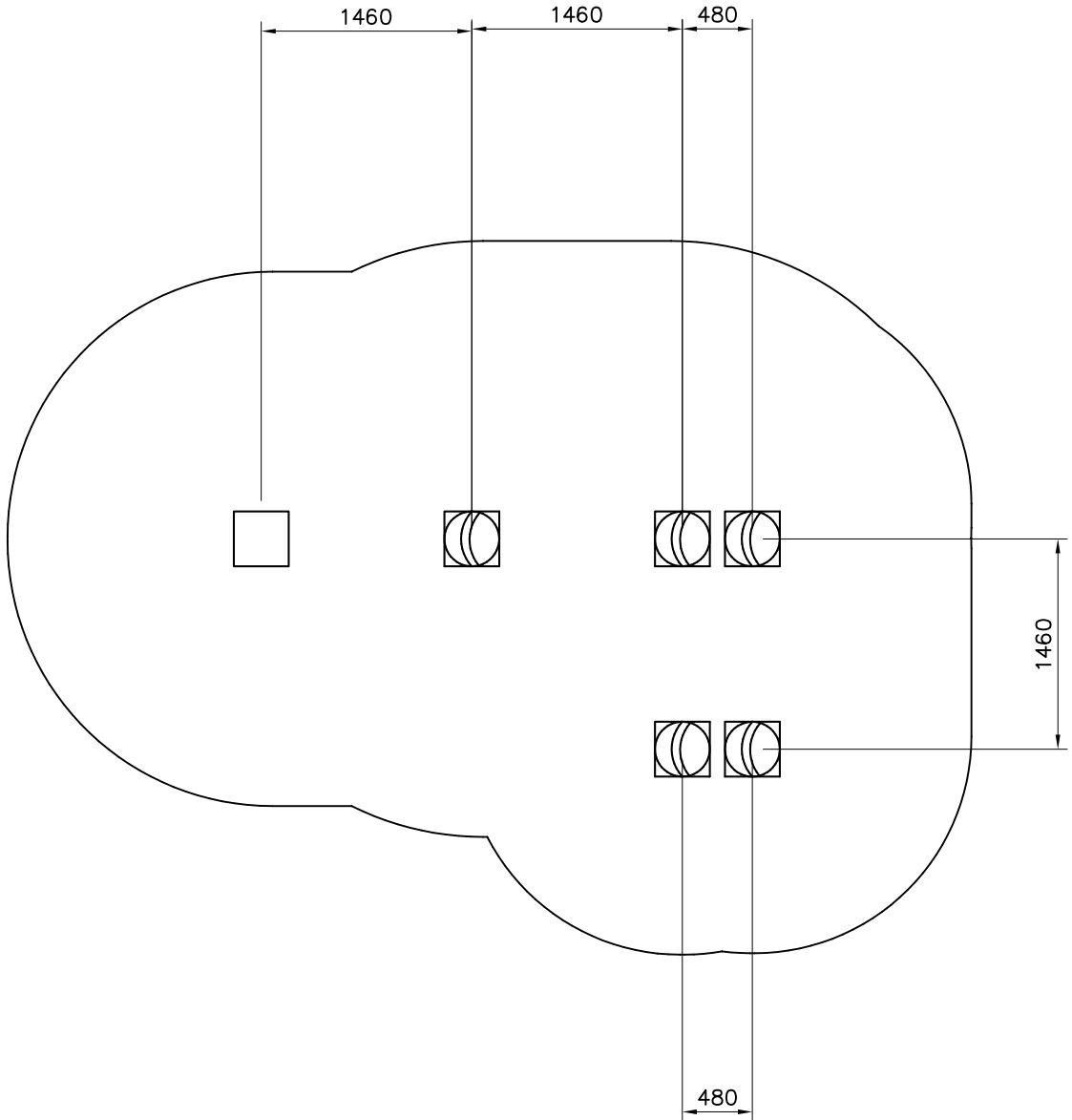

<p>Concrete 500x500x200</p> <p>Sand 0.2-2 mm/ Gravel 2-8 mm</p> <p>150</p> <p>1600</p> <p>S</p>	<p>M10</p> <p>905104</p> <p>903112</p>	<p>Concrete 500x500x300</p> <p>Sand 0.2-2 mm/ Gravel 2-8 mm</p> <p>100</p> <p>650</p> <p>S</p>

- EN/AS Impact Area 26 m²
- - - Falling Space 25.9 m²
Max Falling Height 2320 mm

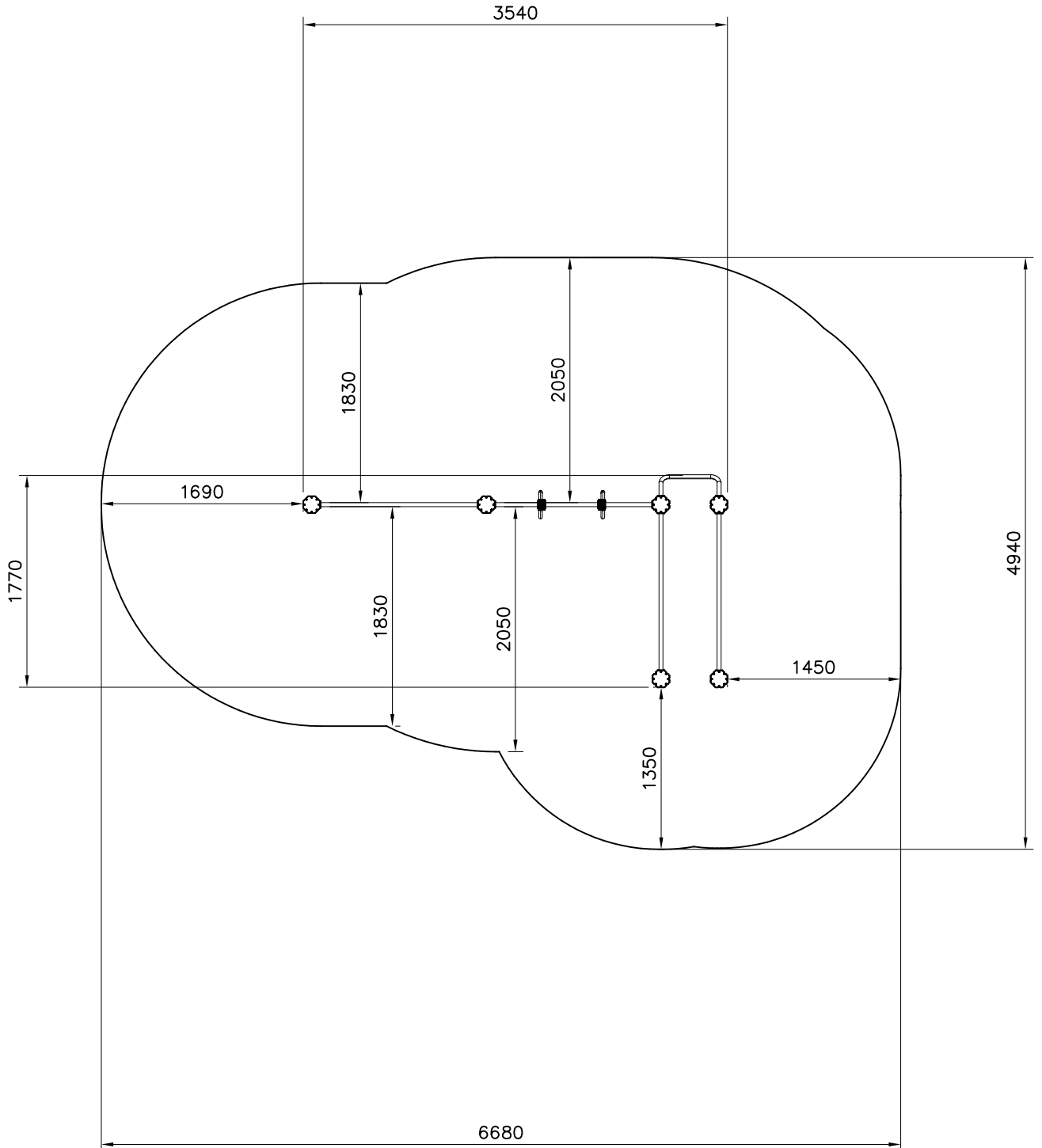
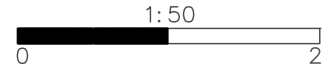

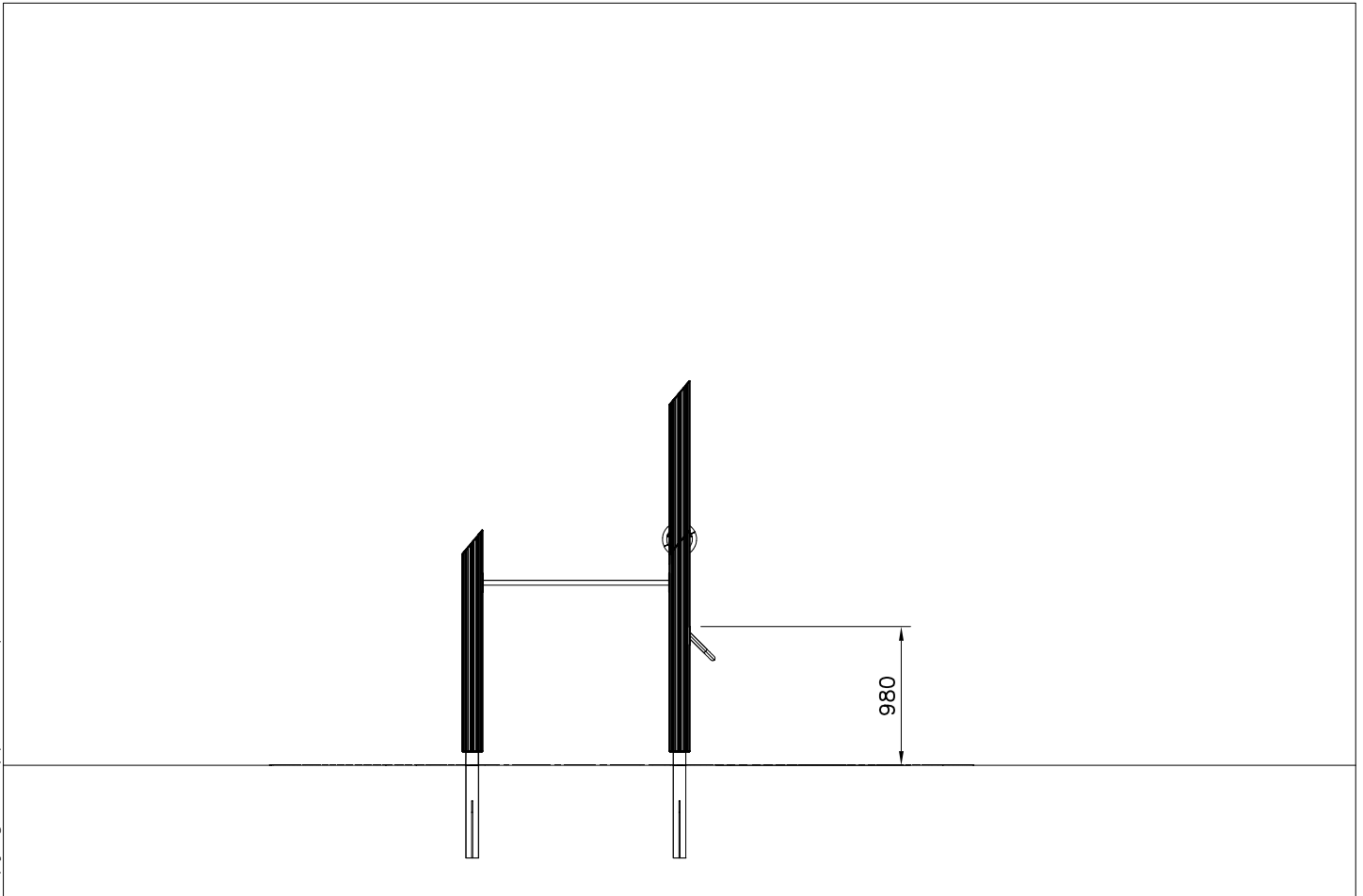
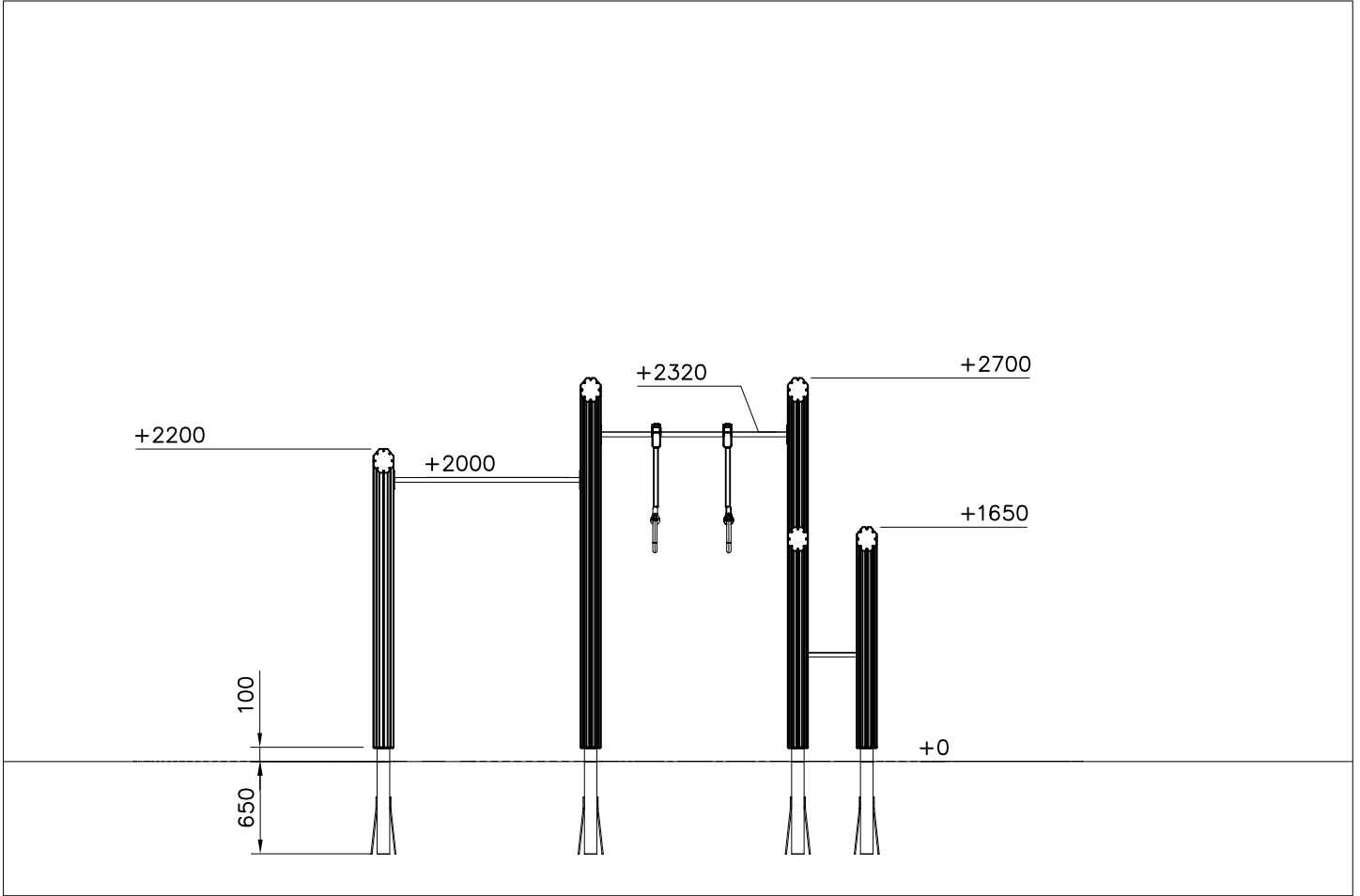

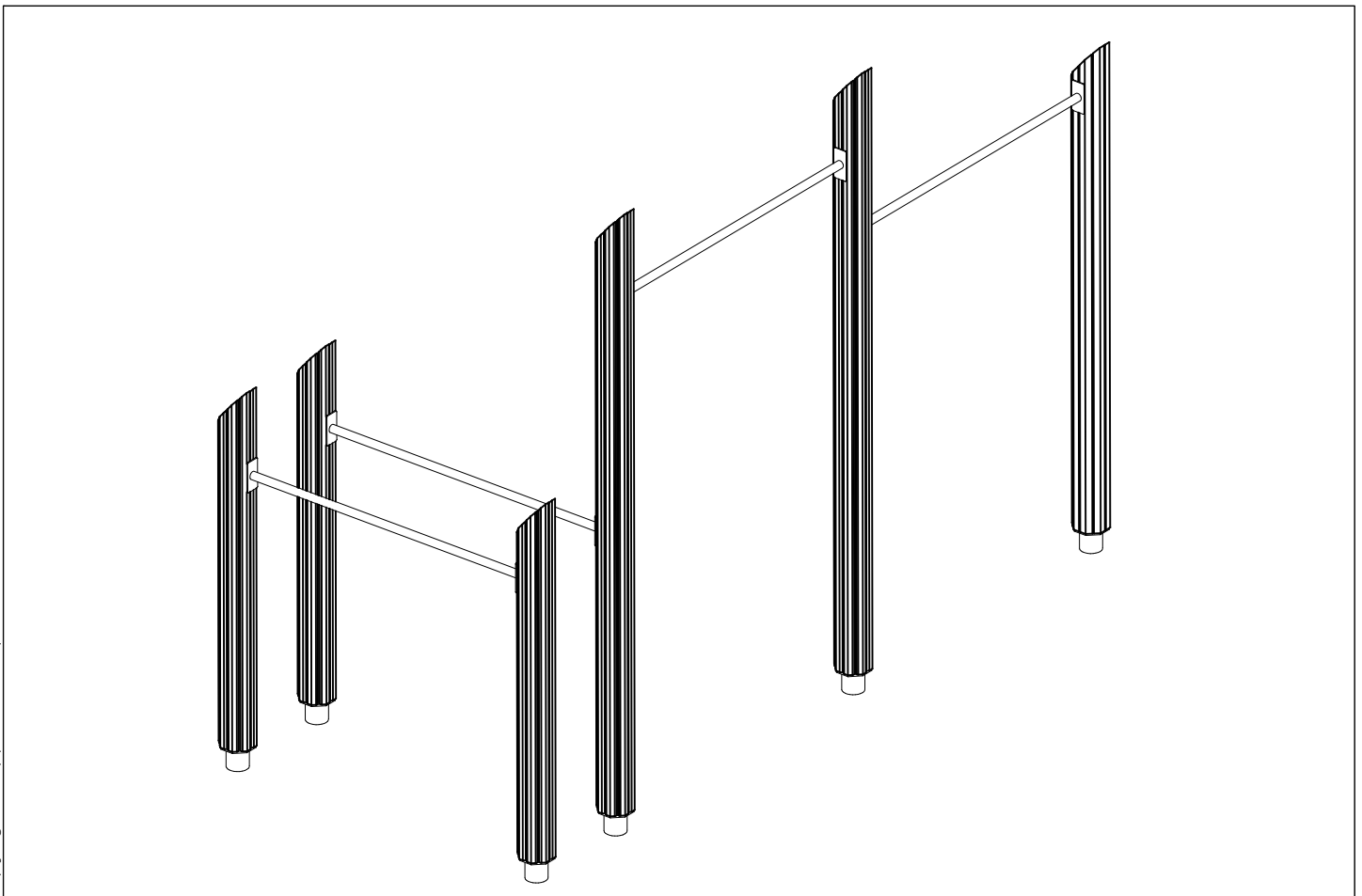
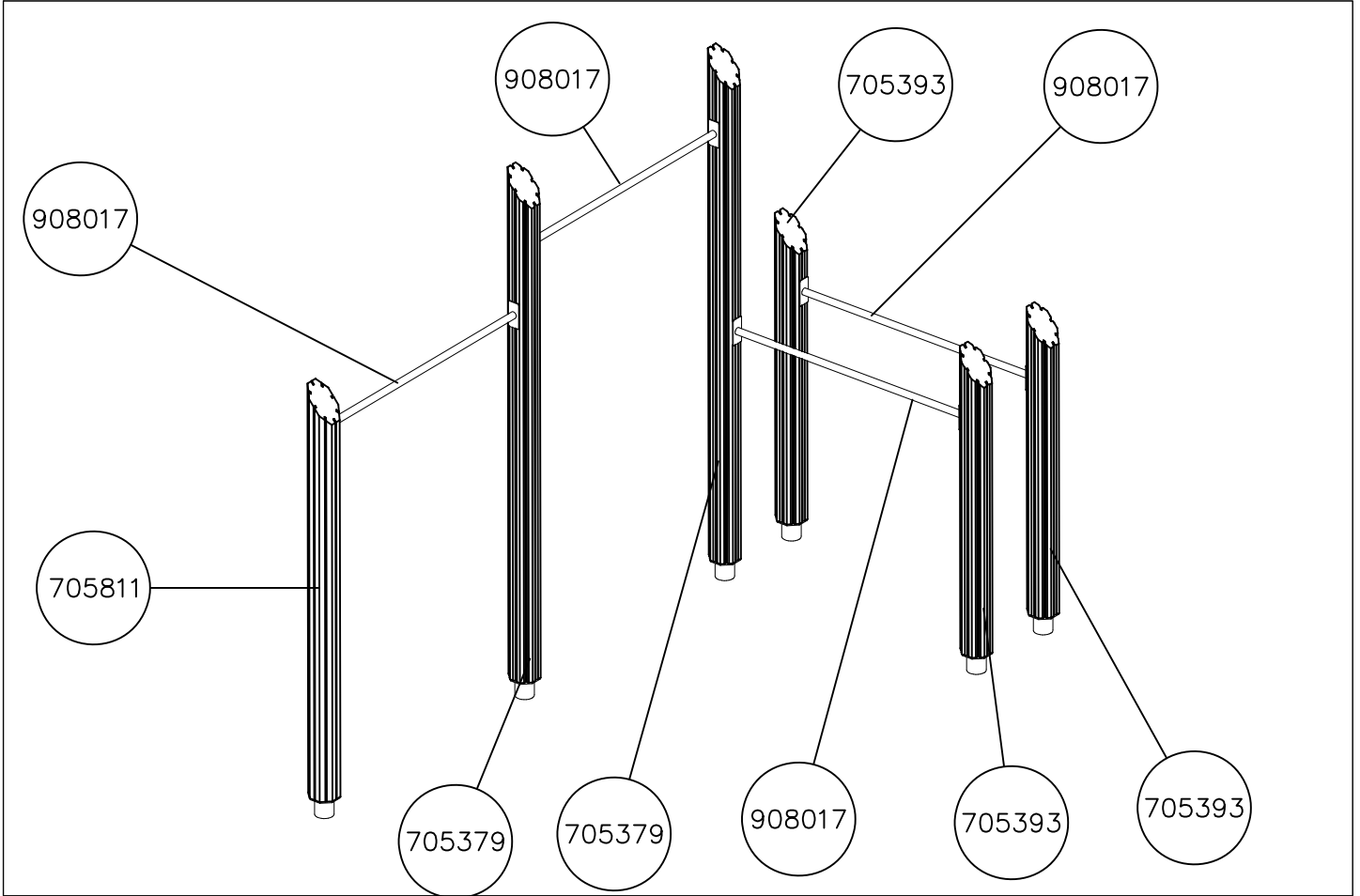

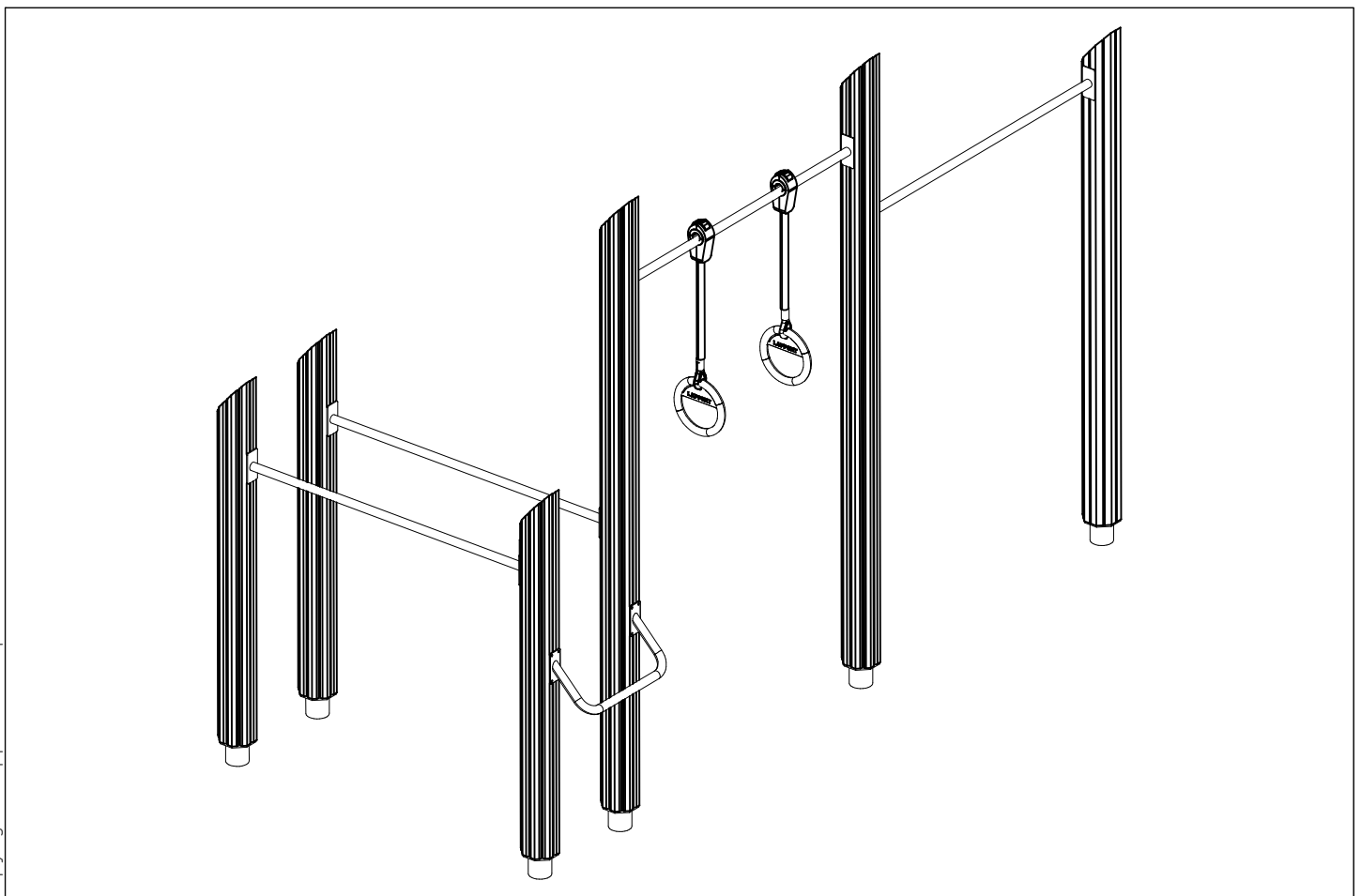
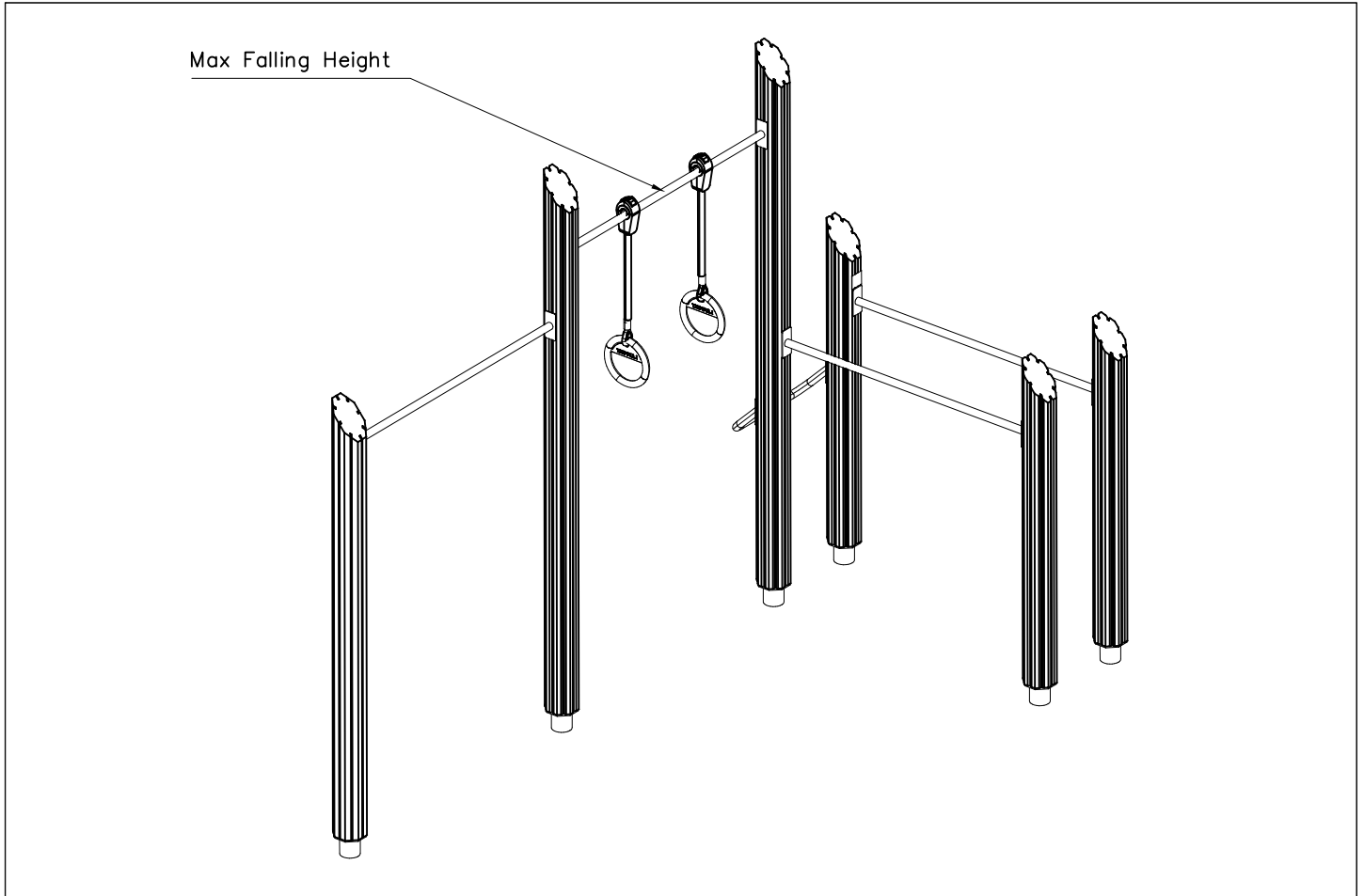

LAPPSET®
BETON FOUNDATION

FOOT

DATE: 27.10.2015

1(1)

② 905104	PCS		PCS
	4		
 M10	PCS		PCS



905104



Tuotekyltti tulee tuotteen mukana yhdellä seuraavista tavoista:

1) Metallinen tuotekyltti ja kiinnitysruuvit

- Kiinnitä tuotekyltti ruuveilla tolppaan noin 2 metrin korkeuteen kuvan 1 mukaisesti.

2) Tuotekyltitarra

- Puhdista maalattu metalli- tai vaneripinta pölystä ja kosteudesta. Liimaa tarra kuvan 2 mukaisesti.
- Huom. Älä kiinnitä tarraa karheapintaiseen laminaattiin tai maalattuun puuhun.

Vår produktmärkning levereras på ett av följande sätt:

1) Produktskylt i metall

- Fäst skylten med de medföljande skruvarna

2) Självhäftande produktetikett

- Rengör den pulverlackerade metallytan eller laminatyten så att den blir fri från smuts och fukt. Fäst etiketten enligt fig. 2.
- Obs! Fäst ej etiketten på detaljer med skrovlig yta eller på målat trä.

Product label is delivered by one of following ways:

1) Metal product label and screws

- Fasten the label with screws.

2) Label sticker

- Clean the painted metal or plywood surface from dirt and moisture. Fasten the sticker as shown in the figure 2.
- Note. Do not attach the sticker to rough surfaced laminate or painted wood.

La plaque d'informations produit est livrée sous l'une de ces 3 formes :

1) Plaque métallique et vis

- Fixez la plaque à l'aide des vis.

2) Etiquette autocollante

- Avant de coller l'étiquette, nettoyez le composant métallique peint ou la plaque de contreplaqué, de toute saleté. La surface doit être sèche (voir image 2).
- Attention, ne pas coller l'étiquette sur une surface lamellé-collée irrégulière ou sur du bois peint.

Die Auslieferung des Produktaufklebers erfolgt auf eine dieser Arten:

1) Produkt-Schild aus Metall incl. Schrauben

- Die Befestigung des Schildes erfolgt mittels der Schrauben.

2) Aufkleber

- Entfernen Sie zunächst Schmutz und Feuchtigkeit vom lackierten Metall bzw. von der Holzoberfläche und bringen Sie den Aufkleber wie im Bild oben rechts beschrieben auf den gesäuberten Untergrund auf.
- Beachten Sie: Bringen Sie den Aufkleber nicht auf raues laminiertes oder lackiertes Holz an.