

LAPPSET®

FLORA







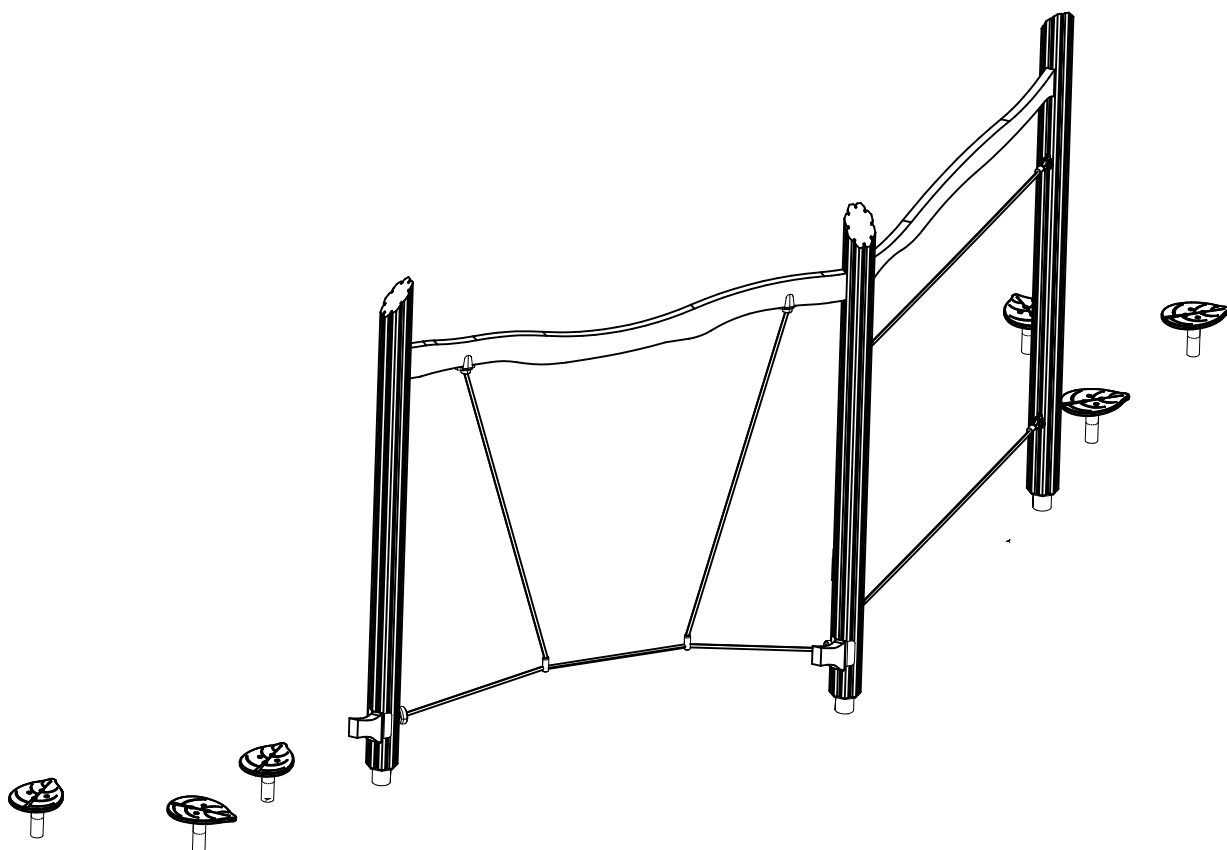

ASENNUSOHJE
MONTERINGSANSVISNING
INSTALLATION INSTRUCTION
AUFBAUANLEITUNG
NOTICE D'INSTALLATION

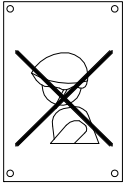
DATE: 18.3.2020

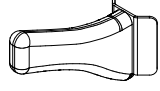
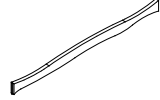
Q14617

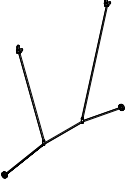
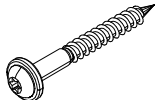
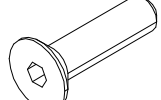
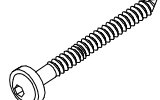

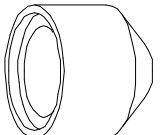
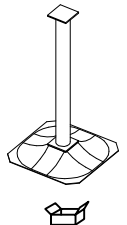
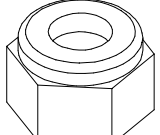
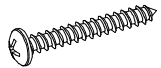
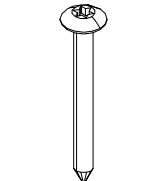
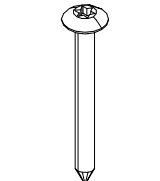
DATE: 18.3.2020

702286  65x65	PCS 1	702339  118x78	PCS 1	705379  l=2594	PCS 3	705431  45x165x2280	PCS 1	705789  l=333	PCS 2	705804  45x145x2280	PCS 1
705808  Ø16x2273	PCS 2	708537 	PCS 1	900240  Ø8x70	PCS 24	901487  M10x40	PCS 24	903093  Ø8x90	PCS 12	903112  l=750	PCS 3
905104  M10	PCS 48	909521 	PCS 6	909637  Ø20/10,5	PCS 24	980114  Ø4x20	PCS 8	980123  Ø7x60	PCS 4	980128  Ø7x40	PCS 2
P03805  20x250x350	PCS 6		PCS		PCS		PCS		PCS		PCS
	PCS		PCS		PCS		PCS		PCS		PCS
	PCS		PCS		PCS		PCS		PCS		PCS

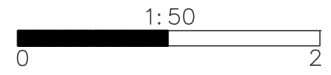

----- Falling Space 43.5 m²
+ Max Falling Height 510 mm +

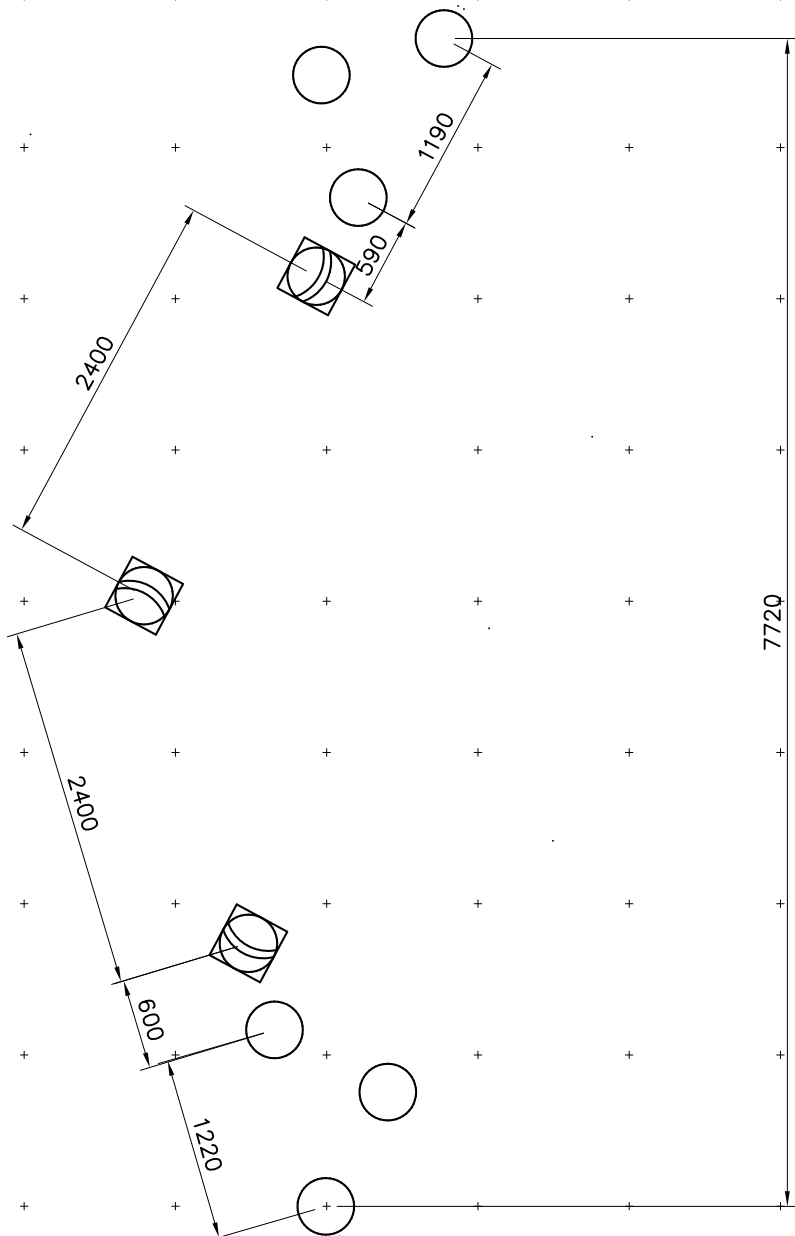

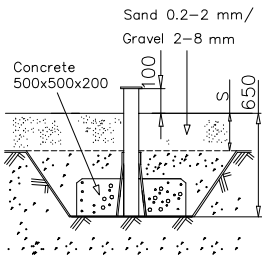
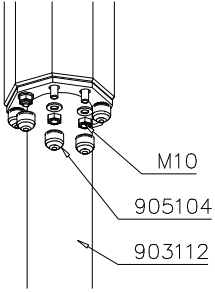
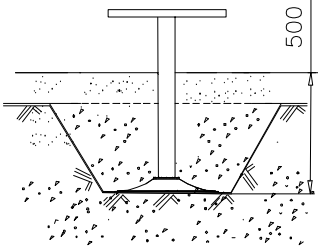
<p>□</p>  <p>Sand 0.2–2 mm/ Gravel 2–8 mm</p> <p>Concrete 500x500x200</p> <p>100</p> <p>S</p> <p>650</p>	<p>□</p>  <p>M10</p> <p>905104</p> <p>903112</p>	<p>○</p>  <p>500</p>



Falling Space 43.5 m²
Max Falling Height 510 mm

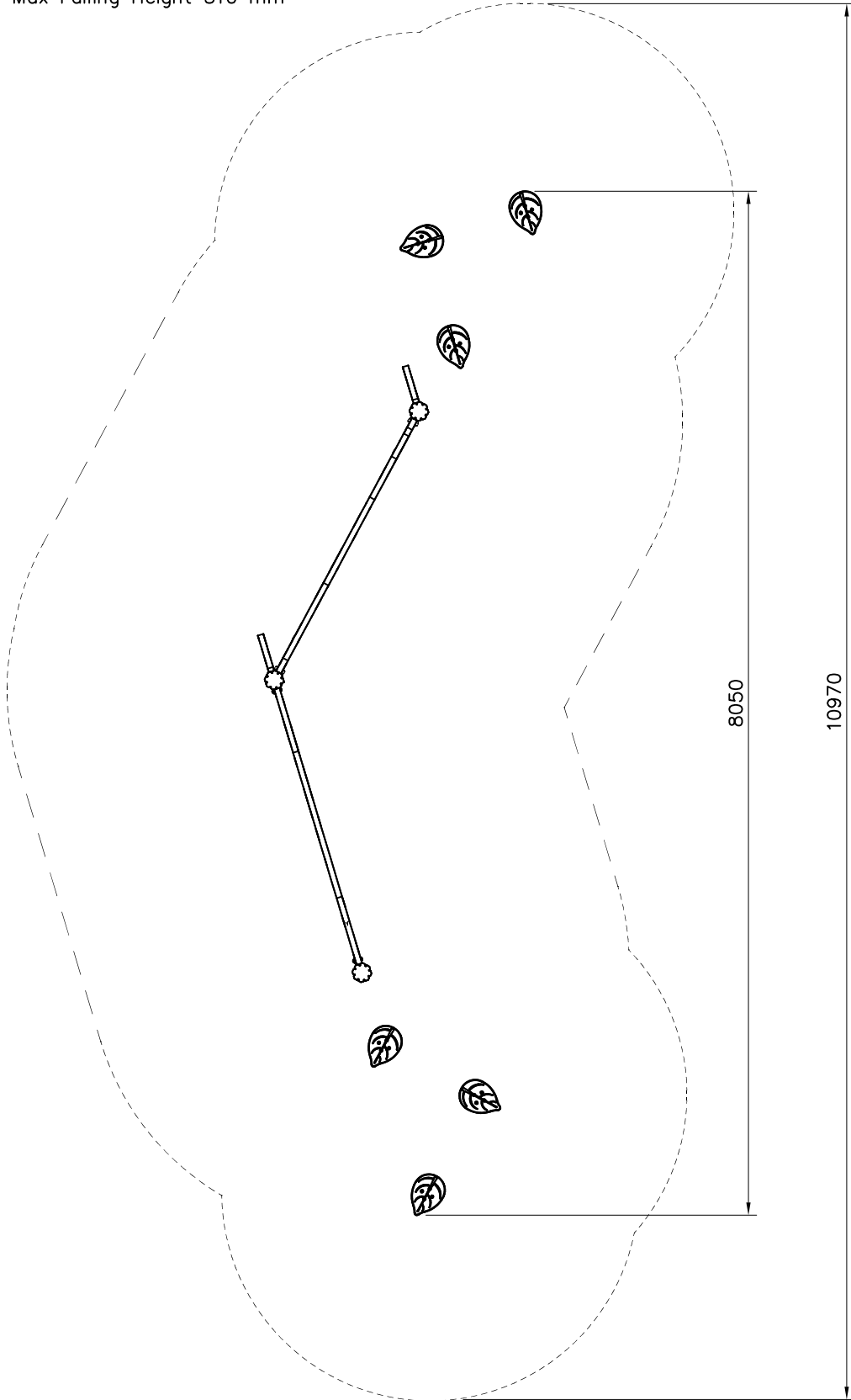
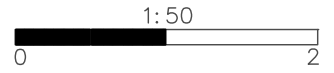

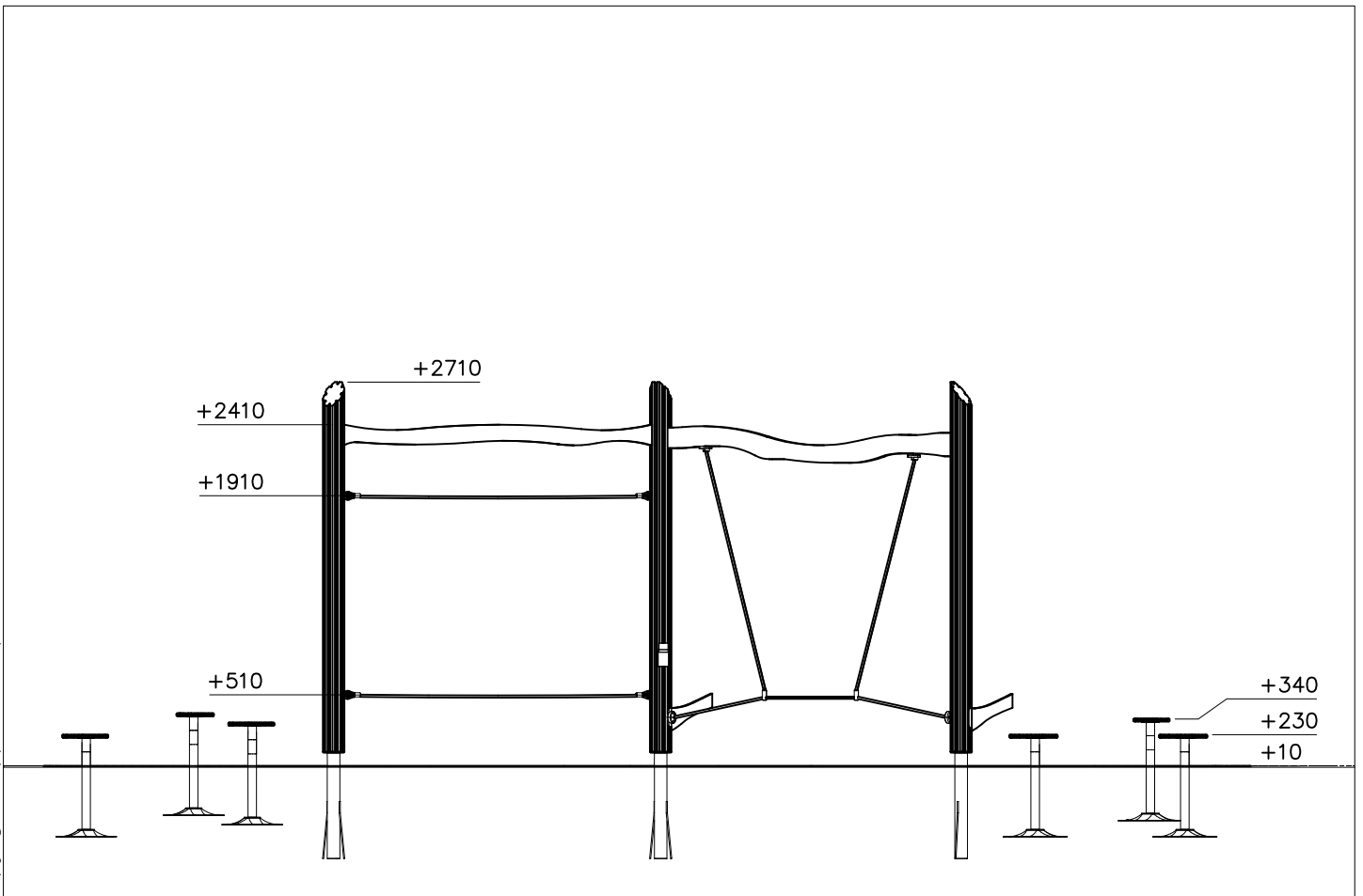
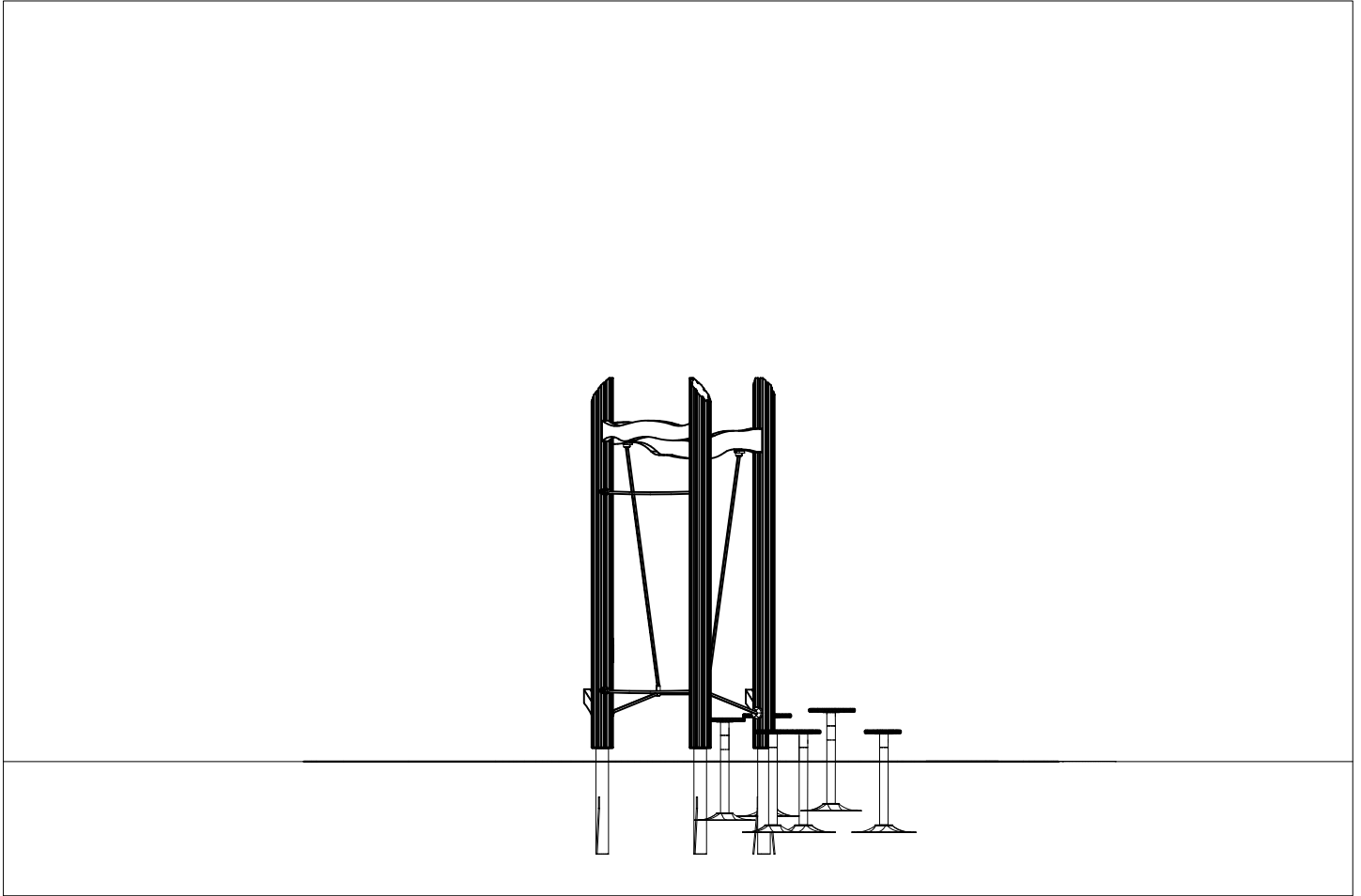

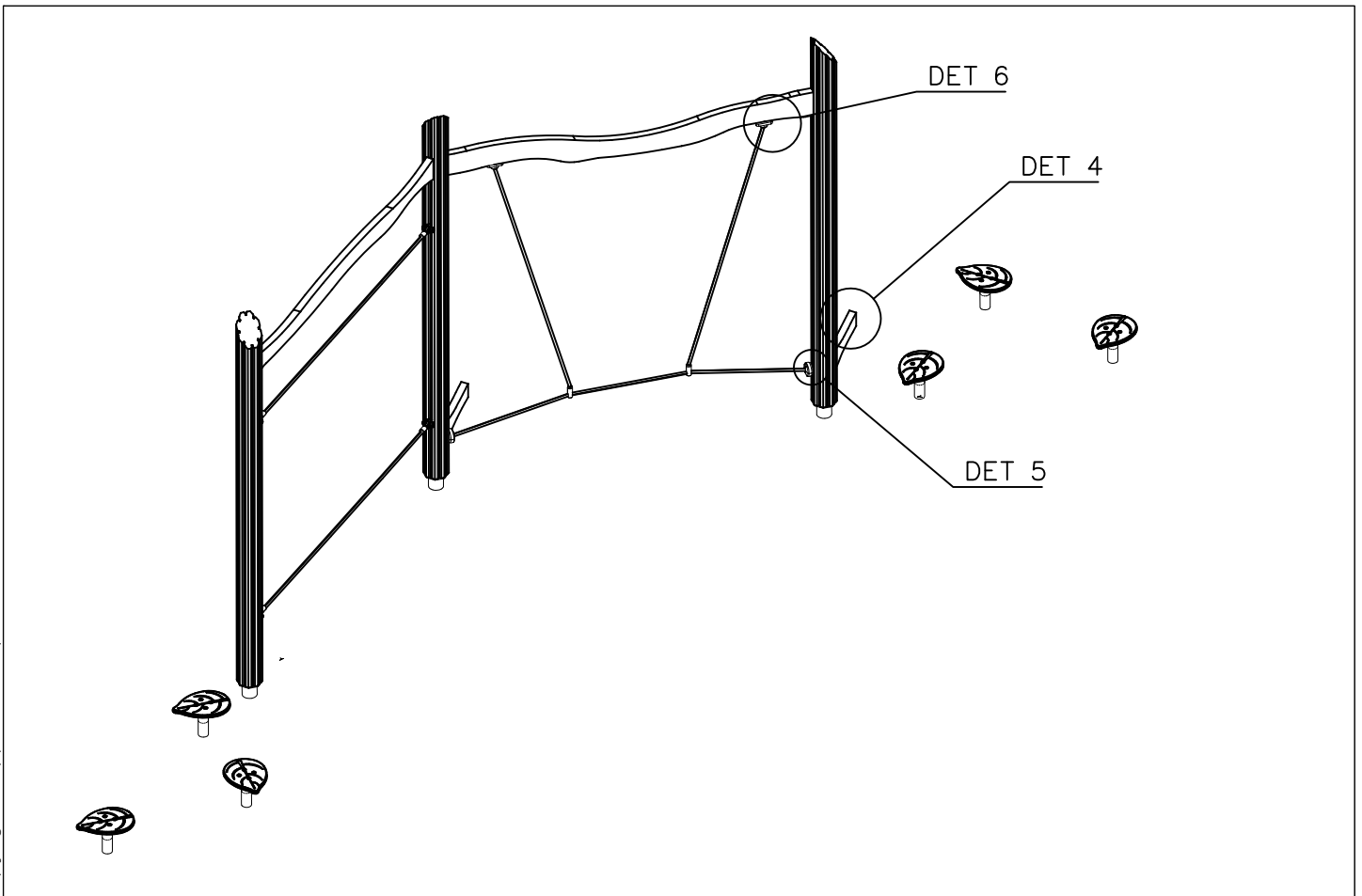
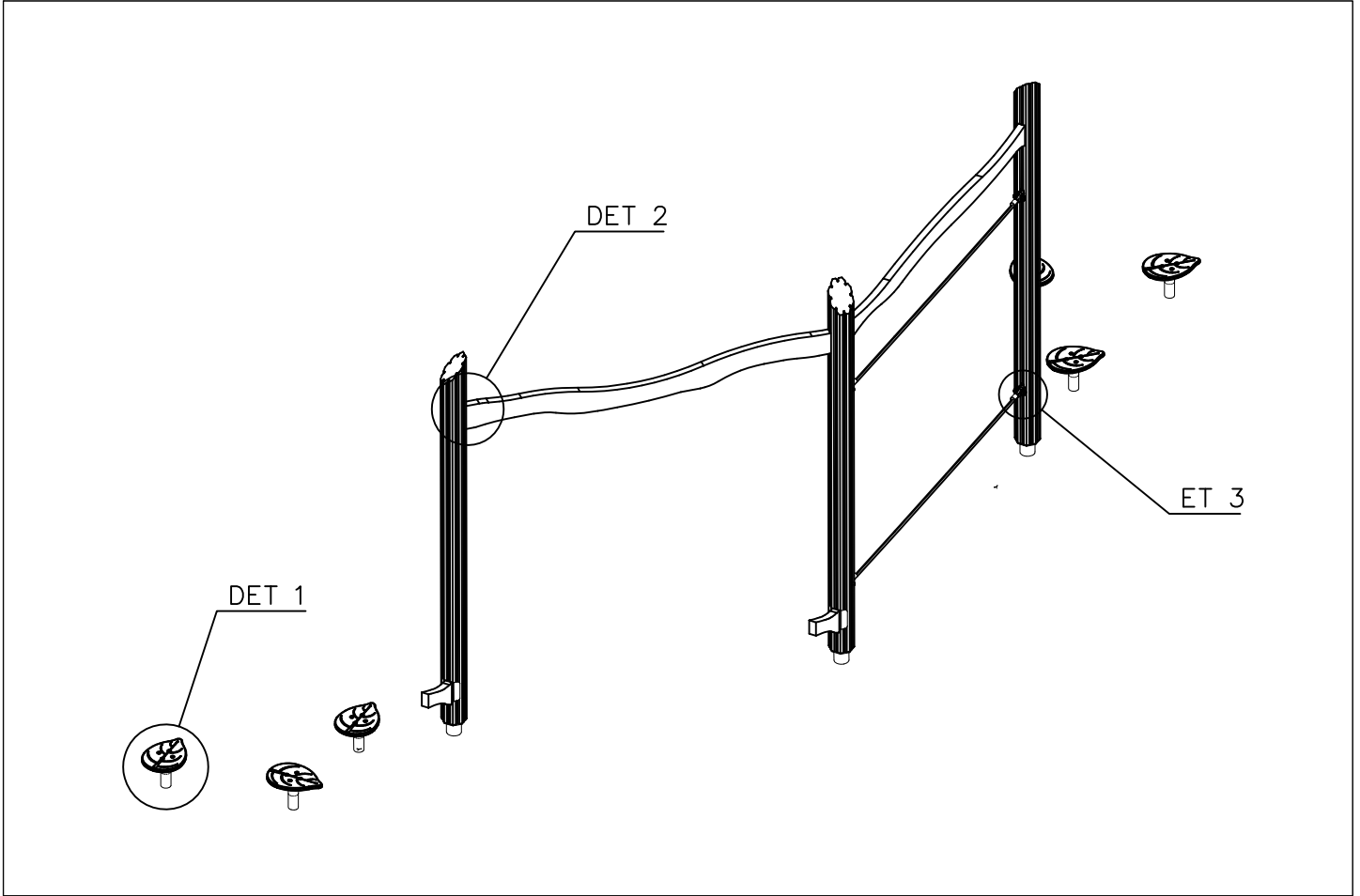

<p>DET 1</p> <p>901487 x 4 M10x40</p> <p>909637x4 M10</p>	<p>DET 2</p> <p>Ø8x90 (903093)</p>	<p>DET 3</p> <p>8x90</p>	
<p>DET 4</p> <p>Ø8x70 900240</p>	<p>DET 5</p> <p>Ø8x70 900240</p>	<p>DET 6</p> <p>Ø7x40 (980128)</p> <p>Ø7x60 (980123)</p>	

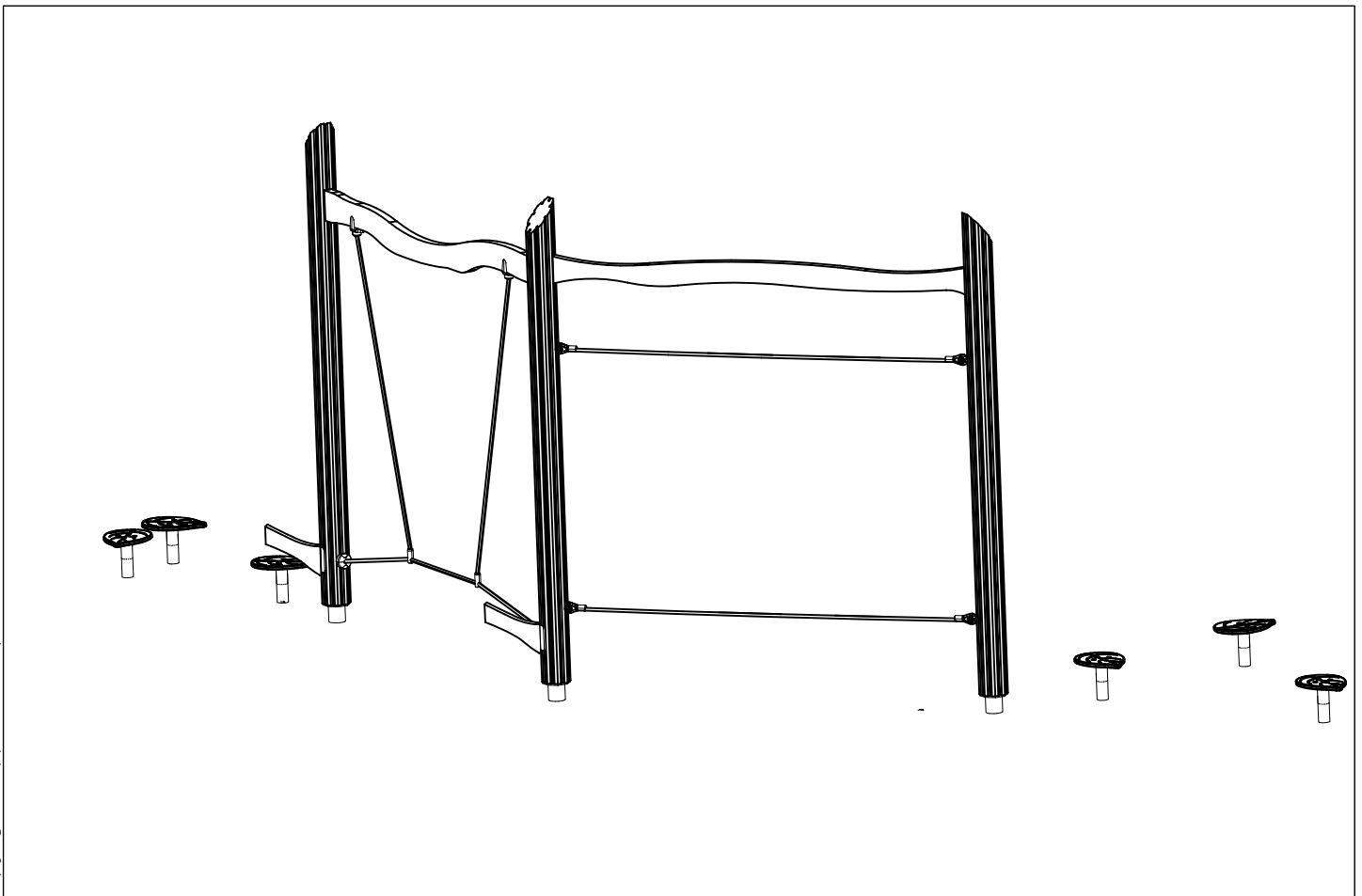
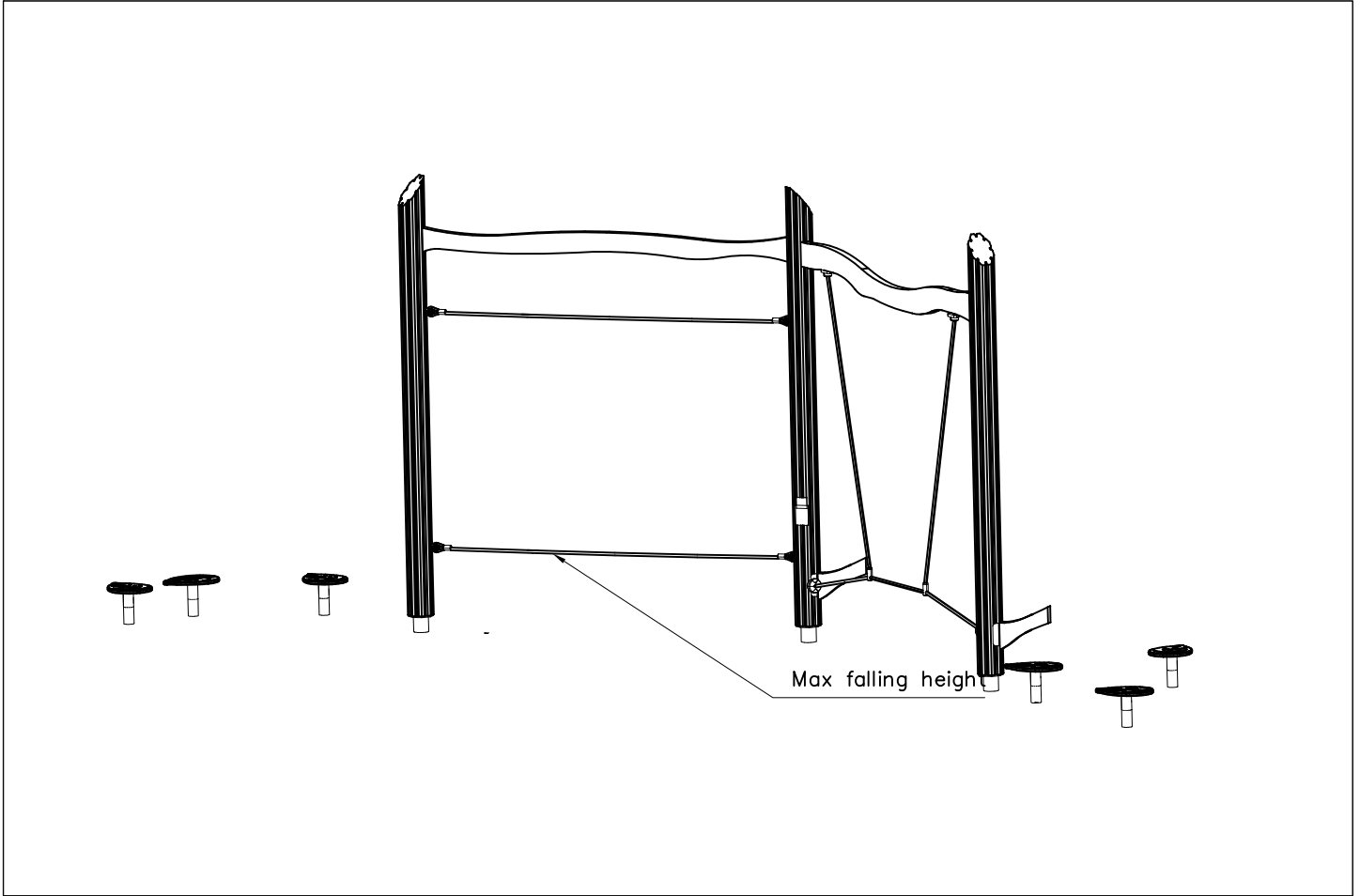

		
<p>$h < 600$</p> <p>Without movement and therefore without Impact Area</p>	<p>Totally hard surfaces.</p> <p>Note. Lappset does <u>not recommend</u> totally hard surfaces at all.</p>	<p>E.g. concrete or asphalt</p> 
<p>$h < 600$</p> <p>With movement e.g. rocking</p>	<p>Materials with very limited impact attenuating properties.</p>	<p>E.g. wood</p> 
<p>$h < 1000$</p>	<p>Materials with significant impact attenuating properties.</p>	<p>fine gravel 0–8 mm</p>  <p>grass</p>  <p>unsorted sand</p> 
<p>$h < 3000$</p>	<p>Loose fill material</p> <p>E.g. sand/gravel 0,25...8 mm D60/D10<3,0 Woodchips 5...30 mm bark 20...80 mm</p>	 <p>\underline{S} \underline{h}</p> <p>30 cm < 2,0 m</p> <p>40 cm < 3,0 m</p>
	<p>Syntethic granulates</p> <p>\underline{S} \underline{h}</p> <p>40 mm ~> 1,2...1,3 m</p> <p>50 mm ~> 1,5...1,7 m</p> <p>60 mm ~> 1,8...2,0 m</p> <p>70 mm ~> 2,1...2,5 m</p> <p>Note. For accurate values, see manufacturer's instructions.</p>	



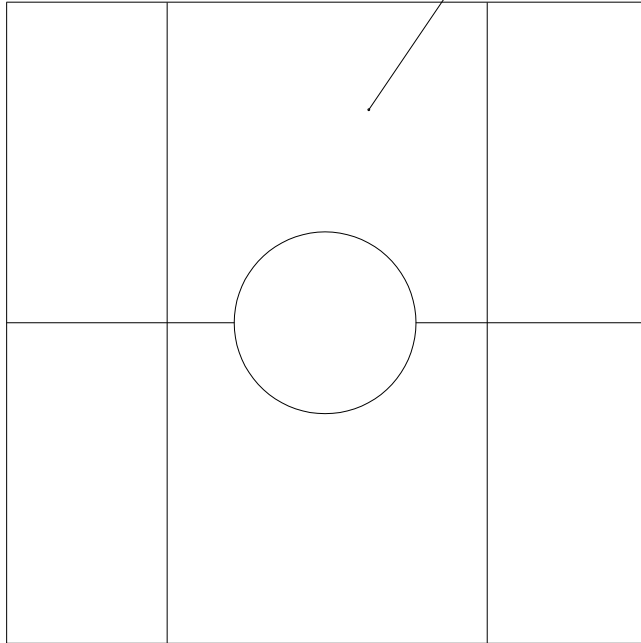

REMOVE SAFETY SURFACE/SAND/GRAVEL
TO CHECK FOUNDATION

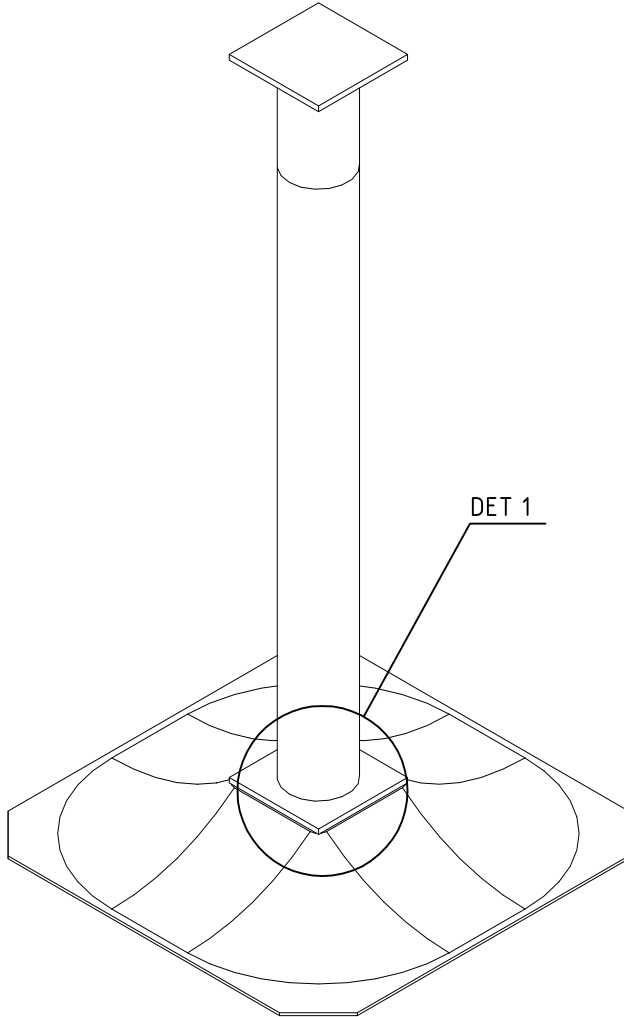

REMOVE SAFETY SURFACE/SAND/GRAVEL
TO CHECK FOUNDATION

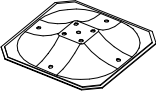



①	909511	PCS	②	909519	PCS
		1			1
③	909637	PCS	④	909638	PCS
		4			8
	M10			Ø20/10.5	
⑤	909639	PCS			PCS
		4			
	M10x25				
		PCS			PCS
		PCS			PCS
		PCS			PCS
		PCS			PCS
		PCS			PCS

DET 1

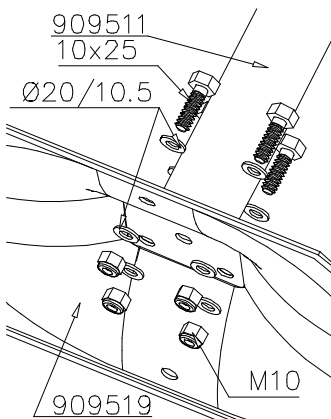



LAPPSET®
BETON FOUNDATION

FOOT

DATE: 27.10.2015

1(1)

② 905104	PCS		PCS
	4		
 M10	PCS		PCS



905104

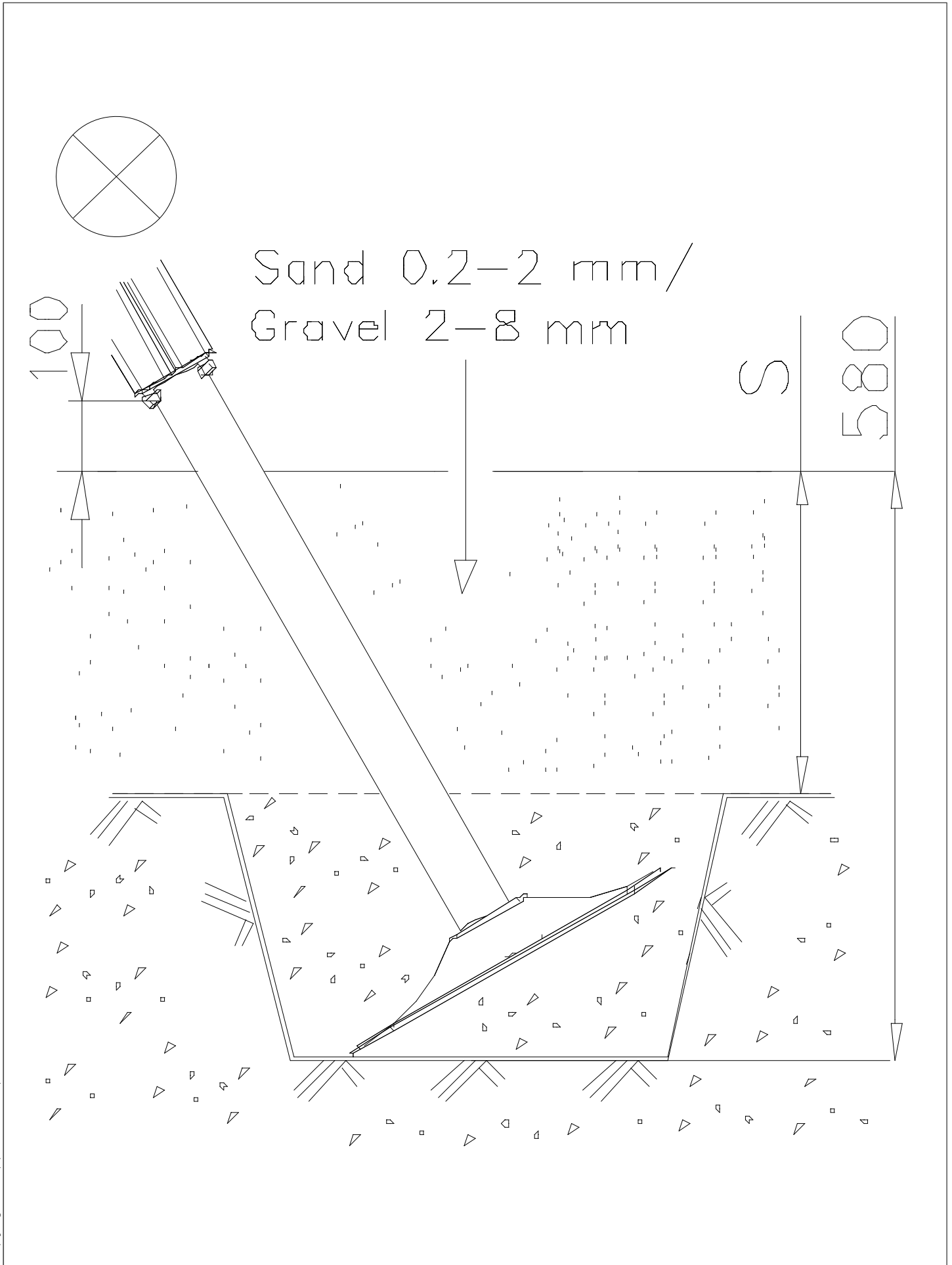



Tuotekyltti tulee tuotteen mukana yhdellä seuraavista tavoista:

1) Metallinen tuotekyltti ja kiinnitysruuvit

- Kiinnitä tuotekyltti ruuveilla tolppaan noin 2 metrin korkeuteen kuvan 1 mukaisesti.

2) Tuotekylttitarra

- Puhdista maalattu metalli- tai vaneripinta pölystä ja kosteudesta. Liimaa tarra kuvan 2 mukaisesti.
- Huom. Älä kiinnitä tarraa karheapintaiseen laminaattiin tai maalattuun puuhun.

Vår produktmärkning levereras på ett av följande sätt:

1) Produktskylt i metall

- Fäst skylten med de medföljande skruvarna

2) Självhäftande produktetikett

- Rengör den pulverlackerade metallytan eller laminatyten så att den blir fri från smuts och fukt. Fäst etiketten enligt fig. 2.
- Obs! Fäst ej etiketten på detaljer med skrovlig yta eller på målat trä.

Product label is delivered by one of following ways:

1) Metal product label and screws

- Fasten the label with screws.

2) Label sticker

- Clean the painted metal or plywood surface from dirt and moisture. Fasten the sticker as shown in the figure 2.
- Note. Do not attach the sticker to rough surfaced laminate or painted wood.

La plaque d'informations produit est livrée sous l'une de ces 3 formes :

1) Plaque métallique et vis

- Fixez la plaque à l'aide des vis.

2) Etiquette autocollante

- Avant de coller l'étiquette, nettoyez le composant métallique peint ou la plaque de contreplaqué, de toute saleté. La surface doit être sèche (voir image 2).
- Attention, ne pas coller l'étiquette sur une surface lamellé-collée irrégulière ou sur du bois peint.

Die Auslieferung des Produktaufklebers erfolgt auf eine dieser Arten:

1) Produkt-Schild aus Metall incl. Schrauben

- Die Befestigung des Schildes erfolgt mittels der Schrauben.

2) Aufkleber

- Entfernen Sie zunächst Schmutz und Feuchtigkeit vom lackierten Metall bzw. von der Holzoberfläche und bringen Sie den Aufkleber wie im Bild oben rechts beschrieben auf den gesäuberten Untergrund auf.
- Beachten Sie: Bringen Sie den Aufkleber nicht auf raues laminiertes oder lackiertes Holz an.