

LAPPSET®

FINNO











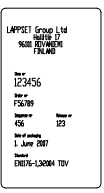

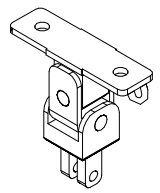

ASENNUSOHJE
MONTERINGSANSVISNING
INSTALLATION INSTRUCTION
AUFBAUANLEITUNG
NOTICE D'INSTALLATION

DATE: 28.6.2022

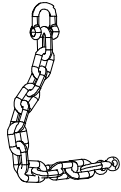
Q10234-2

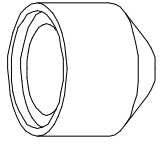
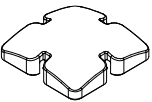
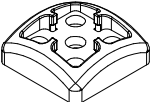
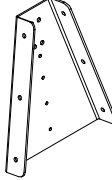
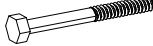

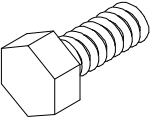
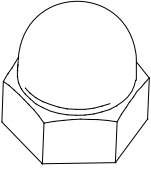
DATE: 28.6.2022

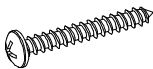
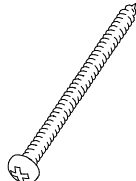
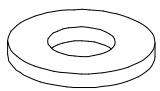
<p>702341</p>  <p>90x50</p>	PCS 1	<p>702533</p>  <p>118x78</p>	PCS 1	<p>703248</p> 	PCS 1	<p>710573</p>  <p>L2650</p>	PCS 4	<p>900965</p>  <p>M10</p>	PCS 4	<p>901958</p> 	PCS 2
<p>901959</p>  <p>L2940</p>	PCS 1	<p>902234</p>  <p>M12</p>	PCS 4	<p>903149</p>  <p>M12x30</p>	PCS 4	<p>903577</p> 	PCS 2	<p>905087</p>  <p>Ø44.5</p>	PCS 12	<p>905104</p>  <p>M10</p>	PCS 16
<p>905138</p> 	PCS 4	<p>905196</p> 	PCS 4	<p>905991</p> 	PCS 2	<p>906499</p>  <p>M12x110</p>	PCS 4	<p>909110</p>  <p>M12x120</p>	PCS 12	<p>909638</p>  <p>Ø20/10.5</p>	PCS 8
<p>909639</p>  <p>M10x25</p>	PCS 4	<p>909644</p>  <p>M12</p>	PCS 16	<p>911155</p>  <p>L650</p>	PCS 4	<p>980114</p>  <p>Ø4x20</p>	PCS 4	<p>980131</p>  <p>Ø6x60</p>	PCS 16	<p>980154</p>  <p>Ø24x13</p>	PCS 28
	PCS		PCS		PCS		PCS		PCS		PCS
	PCS		PCS		PCS		PCS		PCS		PCS
	PCS		PCS		PCS		PCS		PCS		PCS

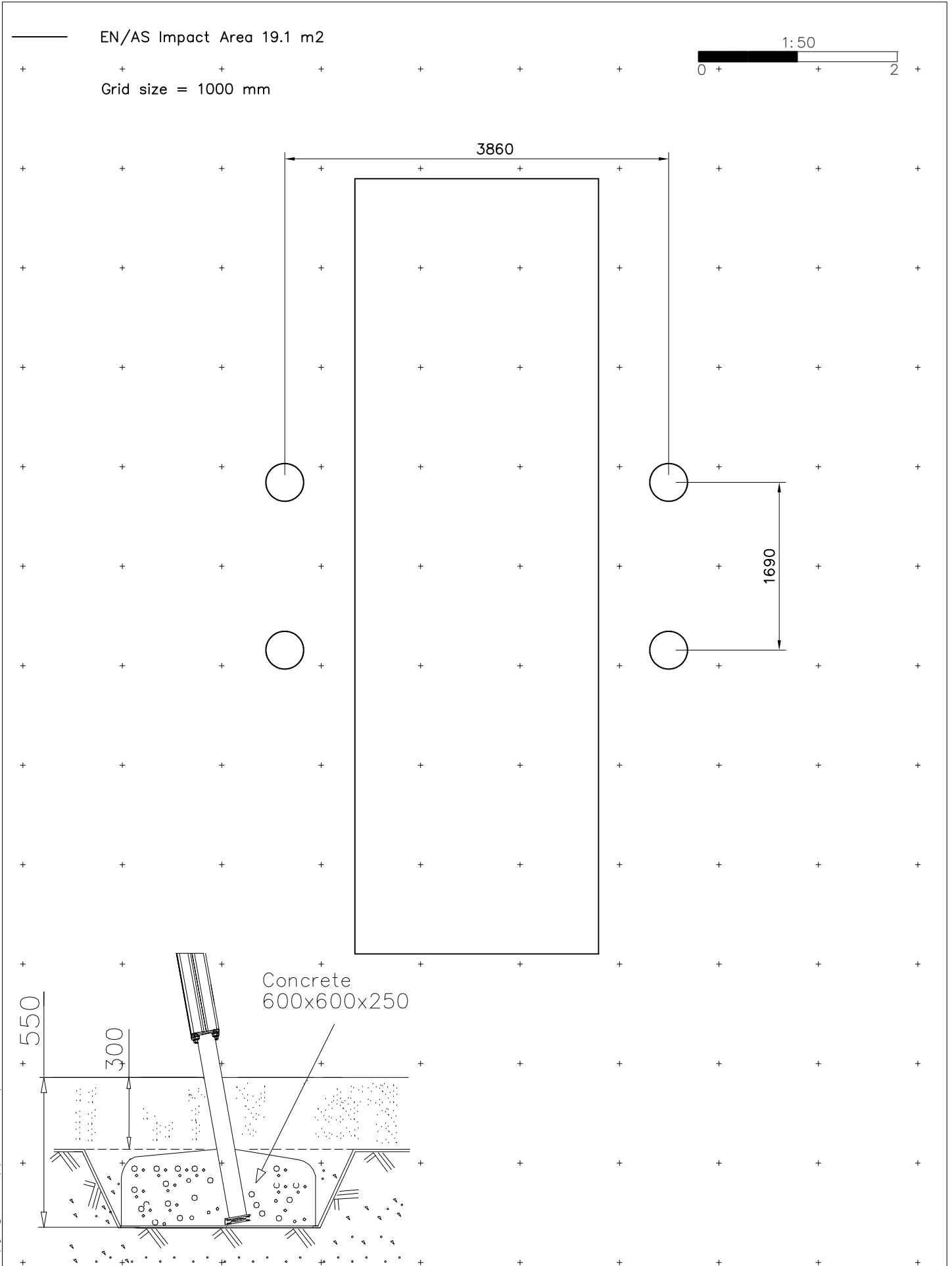

- EN/AS Impact Area 19.1 m²
- - - - Falling Space 19.1 m²
Max Falling Height 1400 mm

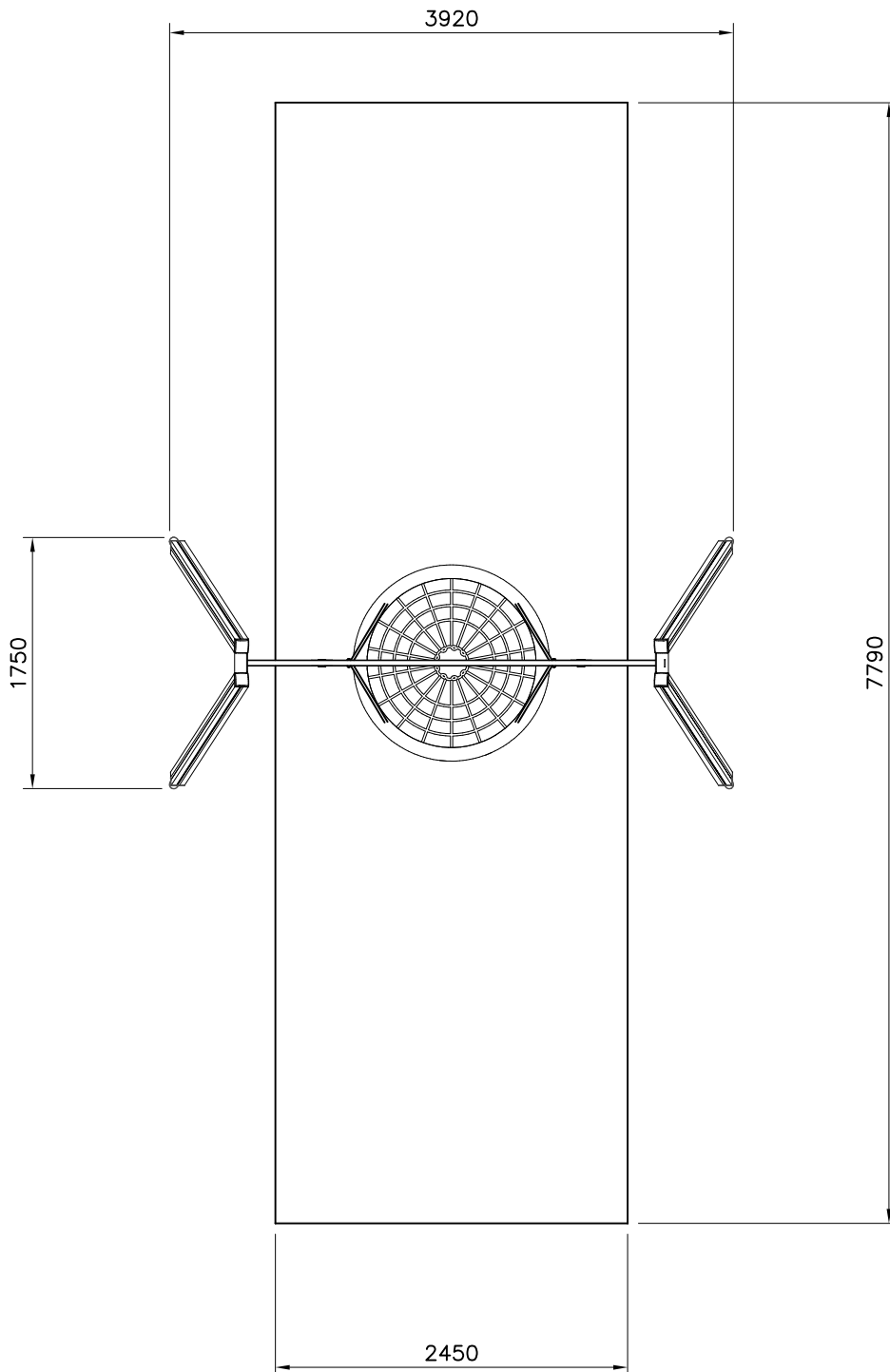
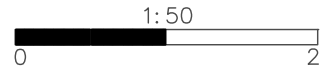

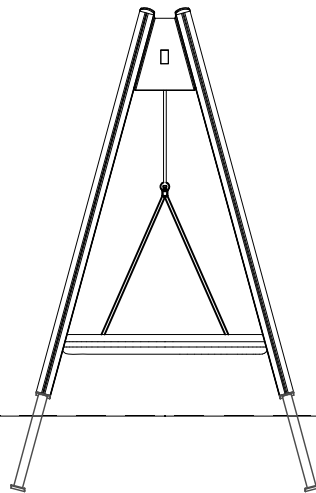
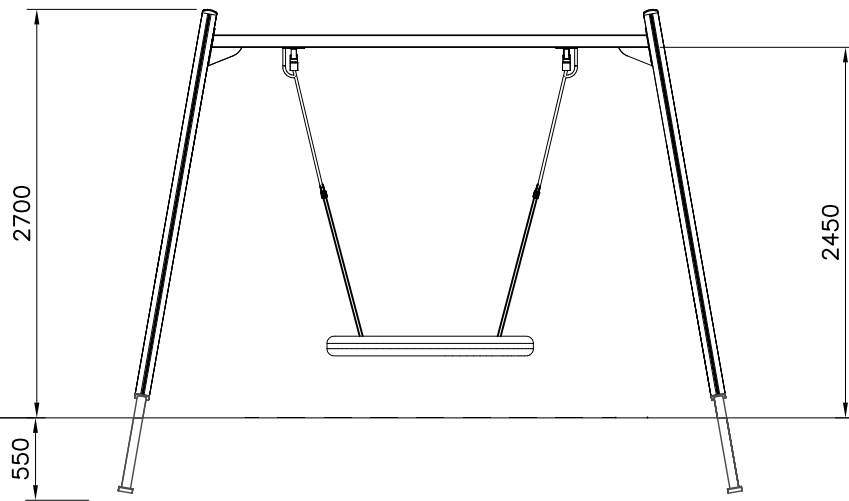

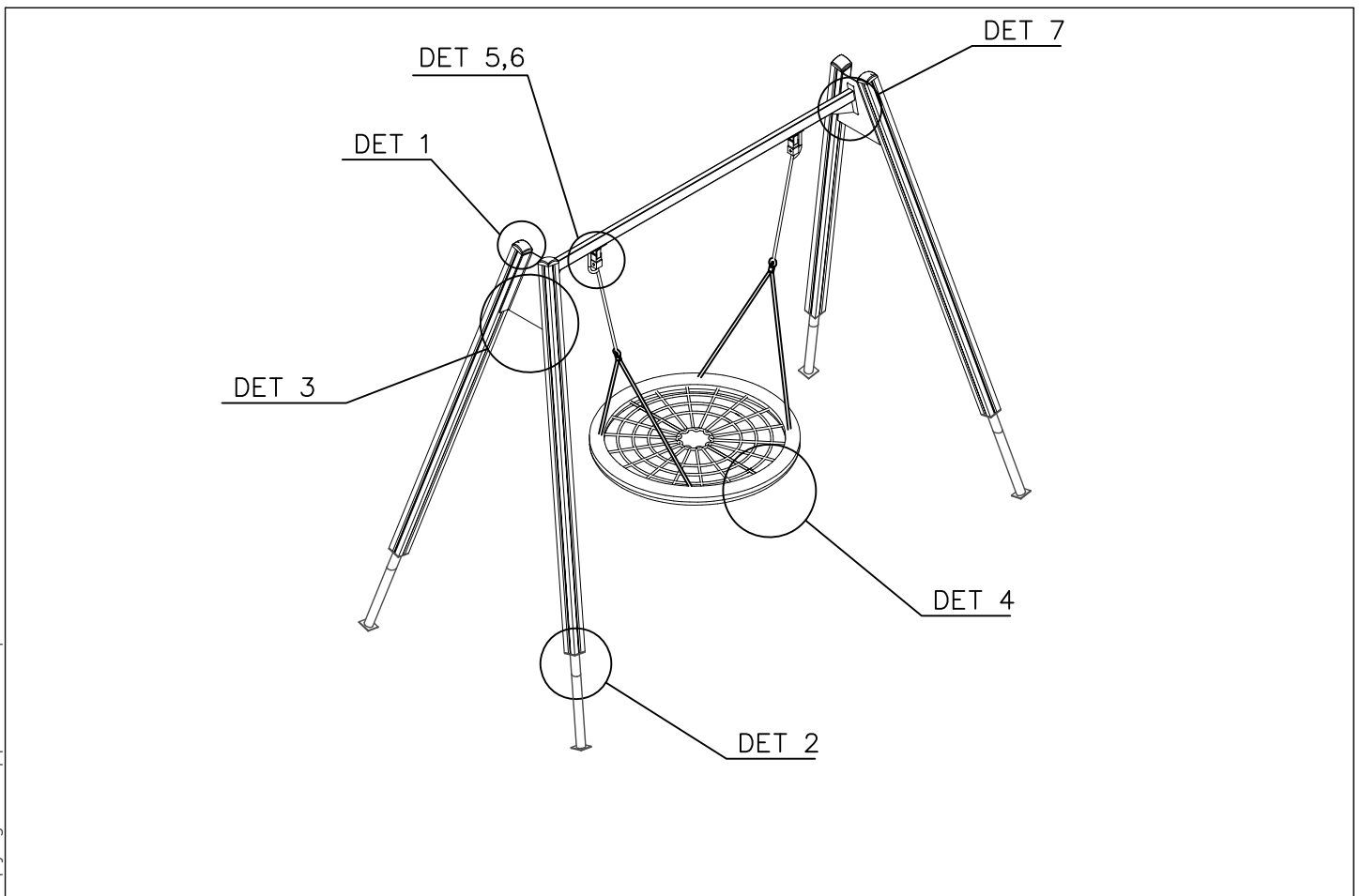
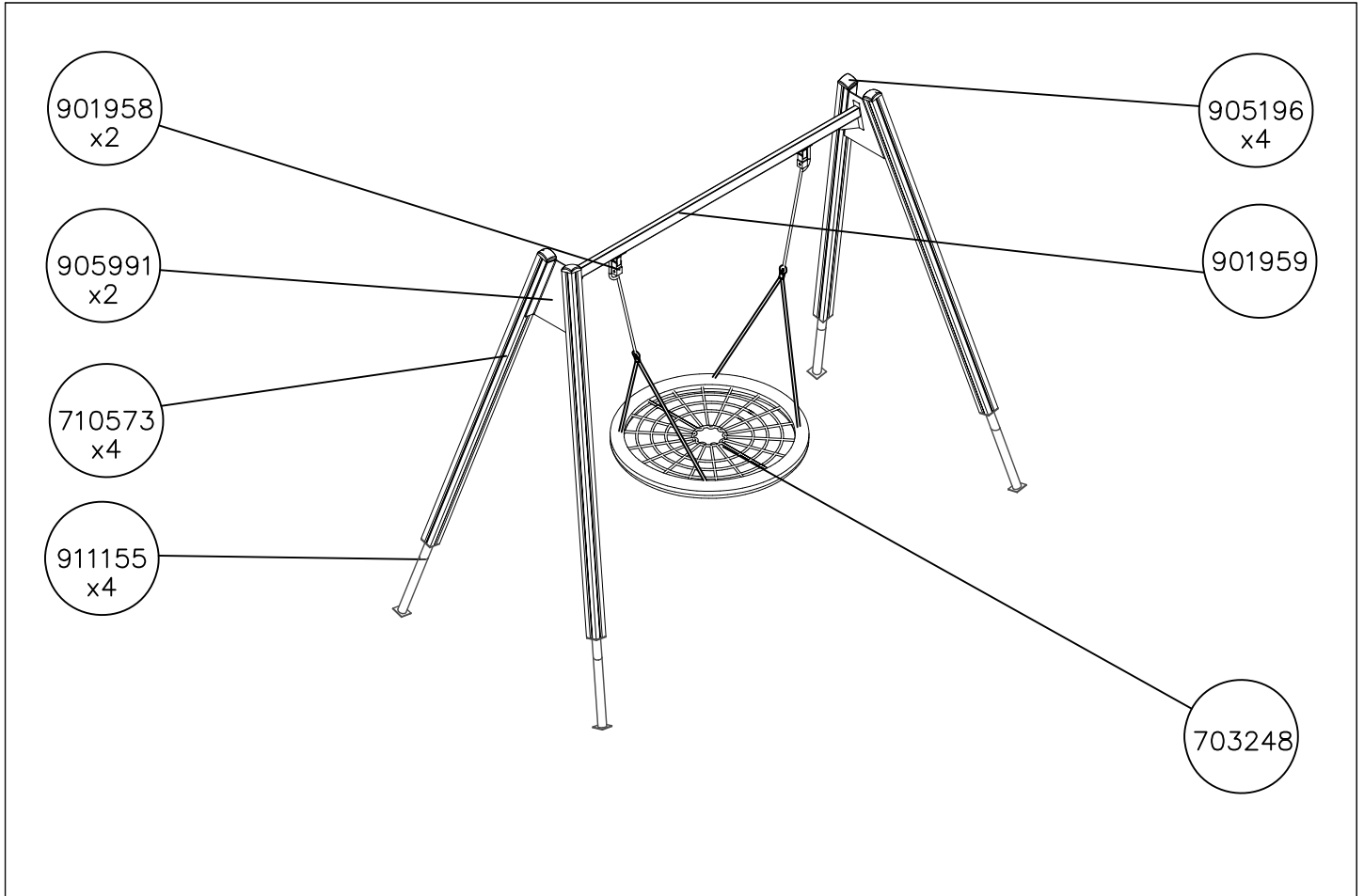

<p>DET 1</p> <p>6x60 980131</p>	<p>DET 2</p> <p>M10 905104 911155</p>	<p>DET 3</p> <p>Ø44.5 905087 M12x120 909110 Ø24/13 (980154) M12 (909644) 40Nm (M12)</p>	<p>DET 4</p> <p>>400</p>
<p>DET 5</p> <p>90Nm (M12) M12x110 Ø24/13 901958 M8x35 M12 M8 CUT EXTRA CHAIN</p>	<p>DET 6</p> <p>901958 903577</p>		
<p>DET 7</p> <p>Ø24/13 (980154) M12 (909644) 80Nm (M12) M12x30 (903149) M10 (900965) 45Nm (M10) M10x25 (909639) Ø20/10.5 (909638)</p>			

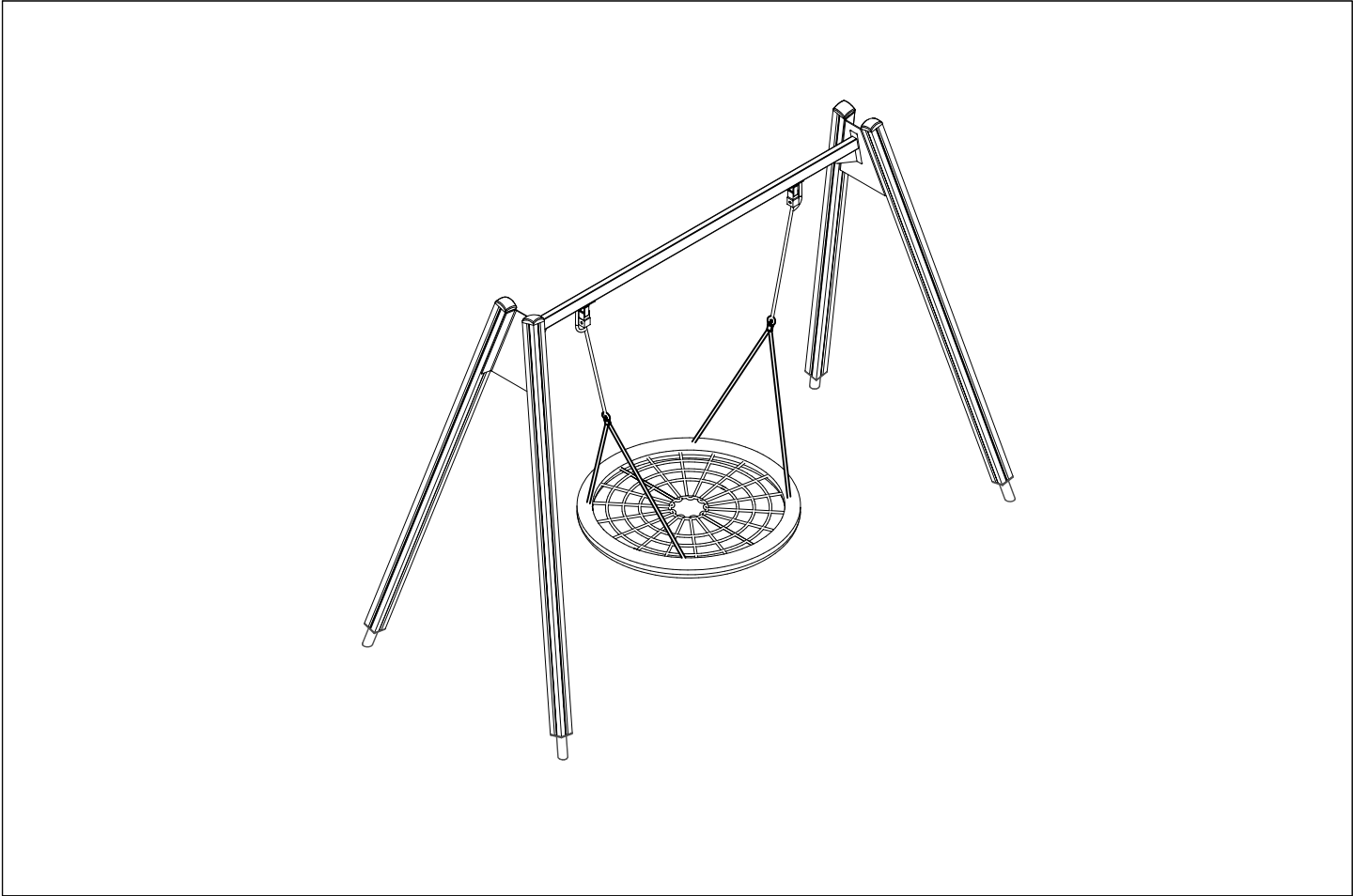

												
<p>$h < 600$</p> <p>Without movement and therefore without Impact Area</p>	<p>Totally hard surfaces.</p> <p>Note. Lappset does <u>not recommend</u> totally hard surfaces at all.</p>	<p>E.g. concrete or asphalt</p> 										
<p>$h < 600$</p> <p>With movement e.g. rocking</p>	<p>Materials with very limited impact attenuating properties.</p>	<p>E.g. wood</p> 										
<p>$h < 1000$</p>	<p>Materials with significant impact attenuating properties.</p>	<p>fine gravel 0–8 mm</p>  <p>grass</p>  <p>unsorted sand</p> 										
<p>$h < 3000$</p>	<p>Loose fill material</p> <p>E.g. sand/gravel 0,25...8 mm D60/D10<3,0 Woodchips 5...30 mm bark 20...80 mm</p>	 <table data-bbox="1021 1691 1332 1792"> <tr> <td>\underline{S}</td> <td>\underline{h}</td> </tr> <tr> <td>30 cm</td> <td>< 2,0 m</td> </tr> <tr> <td>40 cm</td> <td>< 3,0 m</td> </tr> </table>	\underline{S}	\underline{h}	30 cm	< 2,0 m	40 cm	< 3,0 m				
\underline{S}	\underline{h}											
30 cm	< 2,0 m											
40 cm	< 3,0 m											
	<p>Syntethic granulates</p> <table data-bbox="406 1892 758 2060"> <tr> <td>\underline{S}</td> <td>\underline{h}</td> </tr> <tr> <td>40 mm</td> <td>~> 1,2...1,3 m</td> </tr> <tr> <td>50 mm</td> <td>~> 1,5...1,7 m</td> </tr> <tr> <td>60 mm</td> <td>~> 1,8...2,0 m</td> </tr> <tr> <td>70 mm</td> <td>~> 2,1...2,5 m</td> </tr> </table> <p>Note. For accurate values, see manufacturer's instructions.</p>	\underline{S}	\underline{h}	40 mm	~> 1,2...1,3 m	50 mm	~> 1,5...1,7 m	60 mm	~> 1,8...2,0 m	70 mm	~> 2,1...2,5 m	
\underline{S}	\underline{h}											
40 mm	~> 1,2...1,3 m											
50 mm	~> 1,5...1,7 m											
60 mm	~> 1,8...2,0 m											
70 mm	~> 2,1...2,5 m											

REMOVE SAFETY SURFACE/SAND/GRAVEL
TO CHECK FOUNDATION

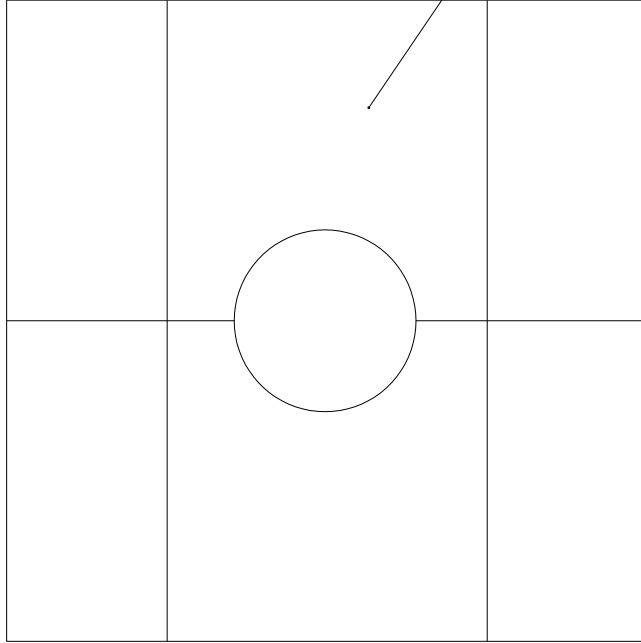

REMOVE SAFETY SURFACE/SAND/GRAVEL
TO CHECK FOUNDATION

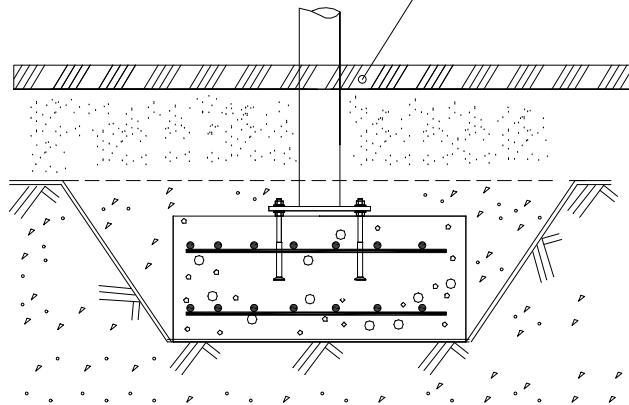

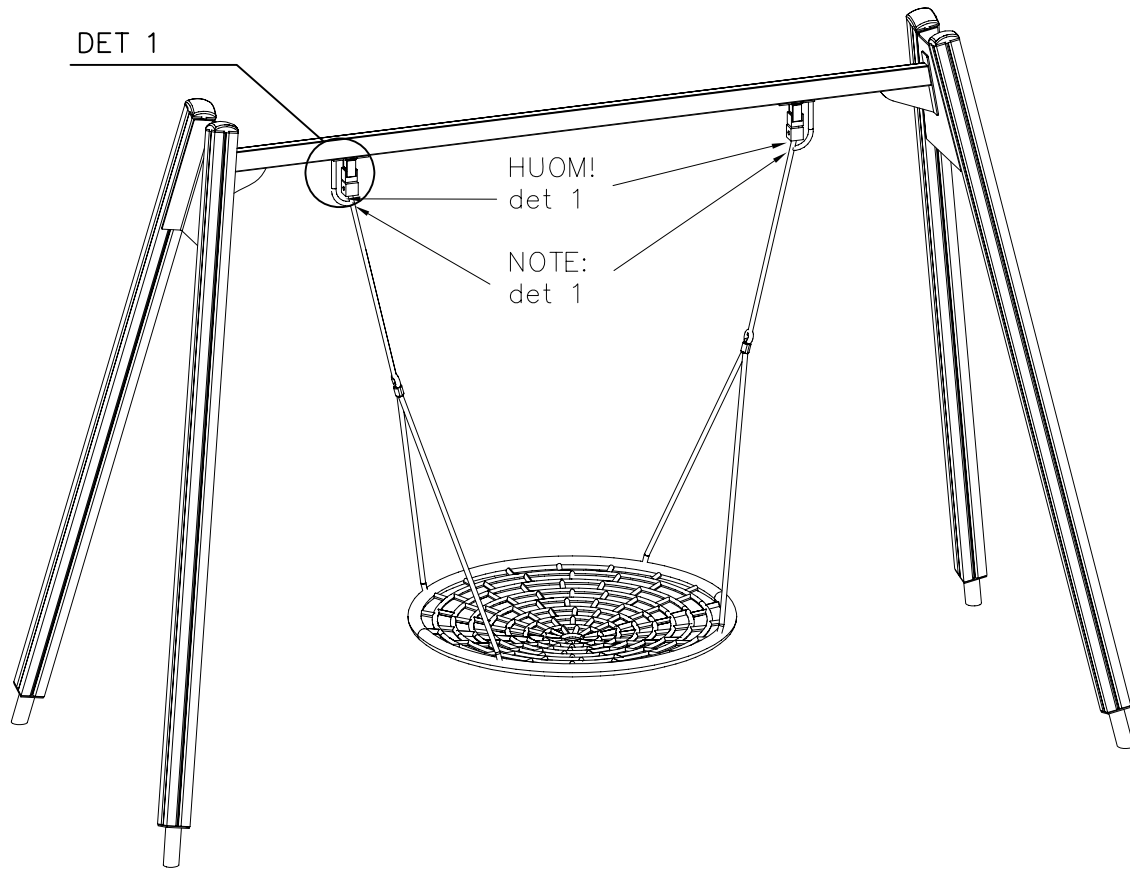

DET 1

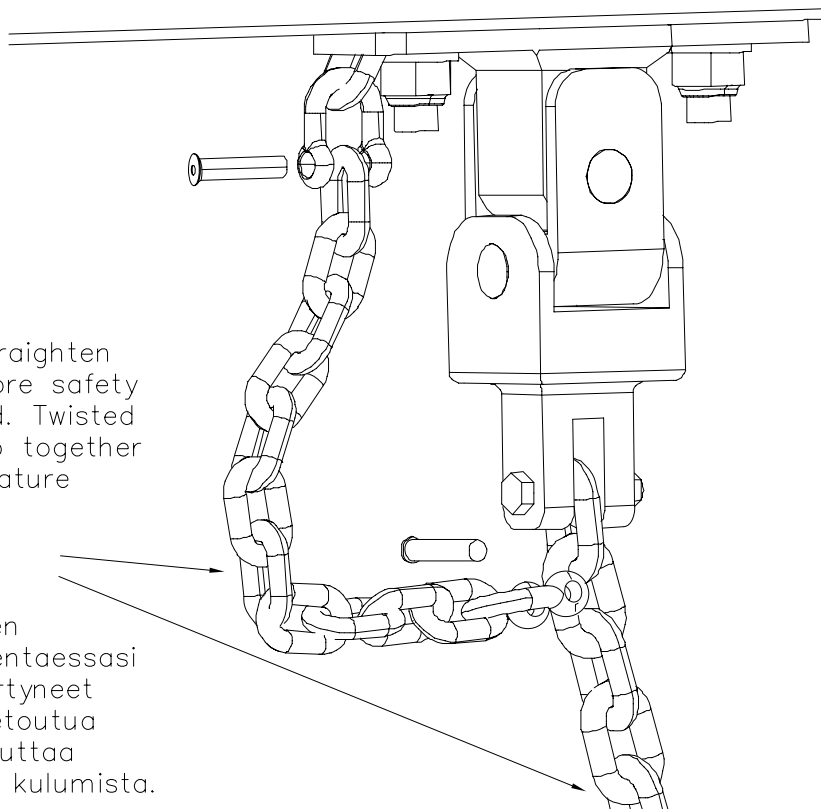

Note:
Make sure to straighten
both chains before safety
chain is installed. Twisted
chains may wrap together
and cause premature
wear.

Huom!
Varmistu ketjujen
suoruudesta asentaessasi
turvaketjua. Kiertyneet
ketjut voivat kietoutua
toisiinsa ja aiheuttaa
ketjujen nopeaa kulumista.

LAPPSET® BETON FOUNDATION

FOOT

DATE: 27.10.2015

1(1)

② 905104	PCS		PCS
	4		
			
	M10		
	PCS		PCS



905104

**Tuotekyltti tulee tuotteen mukana yhdellä seuraavista tavoista:****1) Metallinen tuotekyltti ja kiinnitysruuvit**

- Kiinnitä tuotekyltti ruuveilla tolppaan noin 2 metrin korkeuteen kuvan 1 mukaisesti.

2) Tuotekyltitarra

- Puhdista maalattu metalli- tai vaneripinta pölystä ja kosteudesta. Liimaa tarra kuvan 2 mukaisesti.
- Huom. Älä kiinnitä tarraa karheapintaiseen laminaattiin tai maalattuun puuhun.

Vår produktmärkning levereras på ett av följande sätt:**1) Produktskylt i metall**

- Fäst skylten med de medföljande skruvarna

2) Självhäftande produktetikett

- Rengör den pulverlackerade metallytan eller laminatyten så att den blir fri från smuts och fukt. Fäst etiketten enligt fig. 2.
- Obs! Fäst ej etiketten på detaljer med skrovlig yta eller på målat trä.

Product label is delivered by one of following ways:**1) Metal product label and screws**

- Fasten the label with screws.

2) Label sticker

- Clean the painted metal or plywood surface from dirt and moisture. Fasten the sticker as shown in the figure 2.
- Note. Do not attach the sticker to rough surfaced laminate or painted wood.

La plaque d'informations produit est livrée sous l'une de ces 3 formes :**1) Plaque métallique et vis**

- Fixez la plaque à l'aide des vis.

2) Etiquette autocollante

- Avant de coller l'étiquette, nettoyez le composant métallique peint ou la plaque de contreplaqué, de toute saleté. La surface doit être sèche (voir image 2).
- Attention, ne pas coller l'étiquette sur une surface lamellé-collée irrégulière ou sur du bois peint.

Die Auslieferung des Produktaufklebers erfolgt auf eine dieser Arten:**1) Produkt-Schild aus Metall incl. Schrauben**

- Die Befestigung des Schildes erfolgt mittels der Schrauben.

2) Aufkleber

- Entfernen Sie zunächst Schmutz und Feuchtigkeit vom lackierten Metall bzw. von der Holzoberfläche und bringen Sie den Aufkleber wie im Bild oben rechts beschrieben auf den gesäuberten Untergrund auf.
- Beachten Sie: Bringen Sie den Aufkleber nicht auf raues laminiertes oder lackiertes Holz an.