

# LAPPSET® STRAIGHT/CURVED

# SOFTBLOCK

DATE: 20.5.2020

1(2)

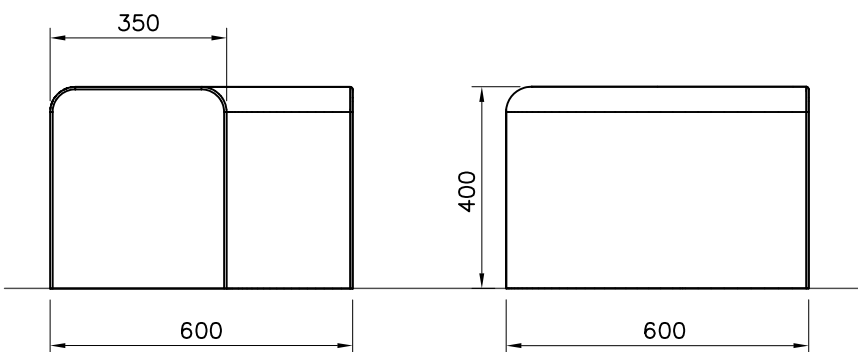
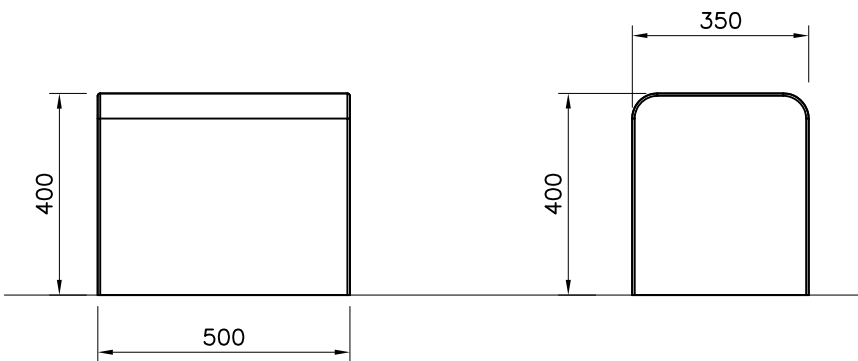
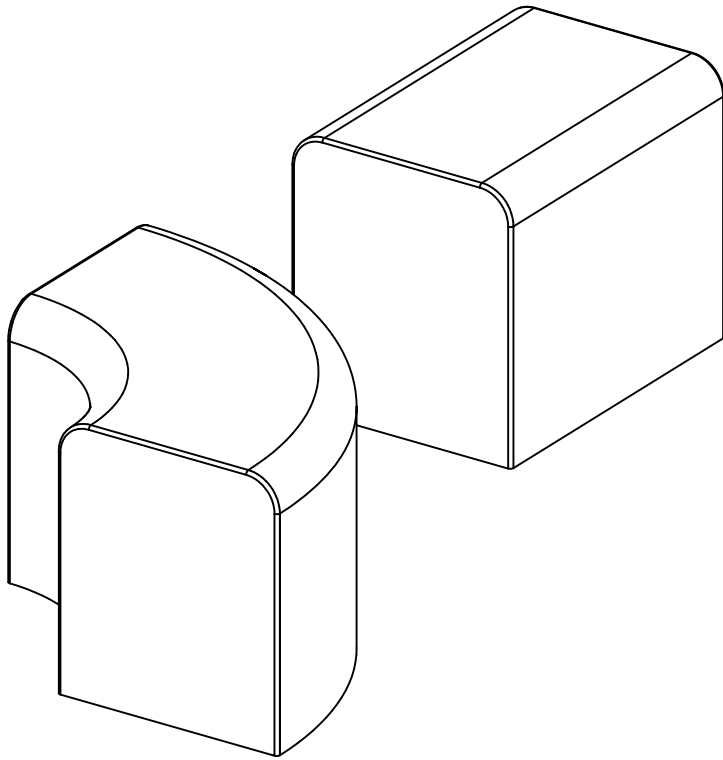

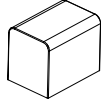
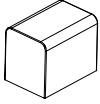
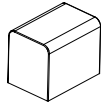
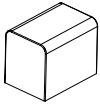
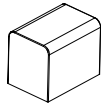
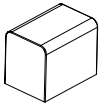
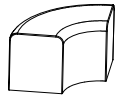
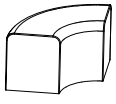
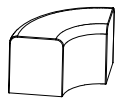
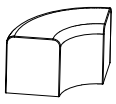
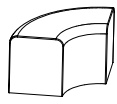
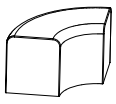
○ 977210	PCS	○ 977220	PCS
			
RED		BLACK	
○ 977230	PCS	○ 977240	PCS
			
GREY		GREEN	
○ 977250	PCS	○ 977260	PCS
			
EPDM1		EPDM2	
○ 977310	PCS	○ 977320	PCS
			
RED		BLACK	
○ 977330	PCS	○ 977340	PCS
			
GREY		GREEN	
○ 977350	PCS	○ 977360	PCS
			
EPDM1		EPDM2	

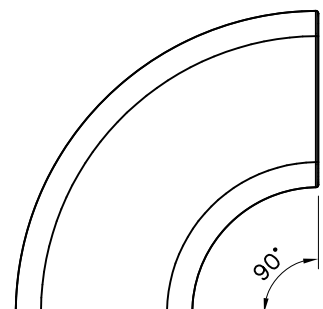

All products are with **surface mounting as default.**

- The sub-base must be even.
- The product can be glued onto the type of ground where adherence is possible, without any special parts.

Optional deep mounting:

- 2 Holes on the bottom of the straight block and curve block.
- 2 Installation pipes will be added. One end to the product and the other end into a concrete foundation
- Ground anchor (977002), tube  $\text{Ø}42,8\text{mm} \times 300\text{mm}$

