

LAPPSET®

FINNO







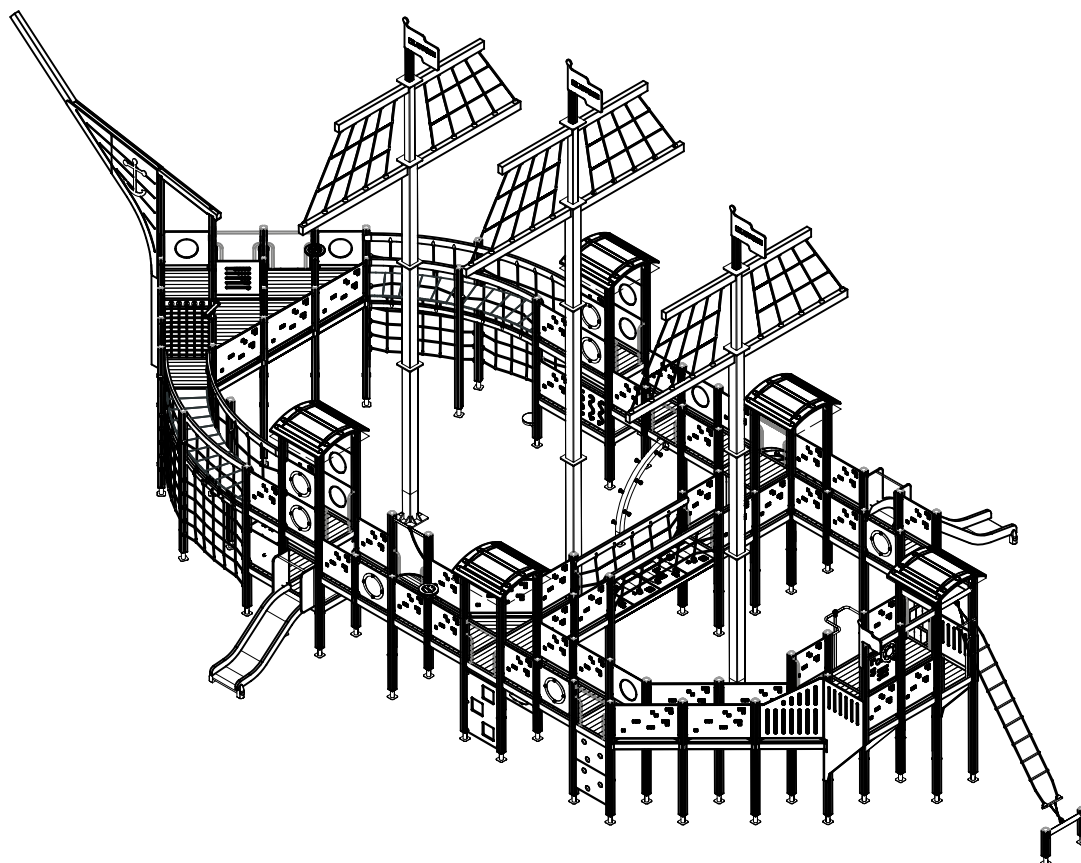



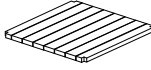
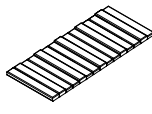
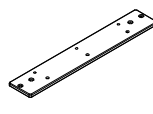

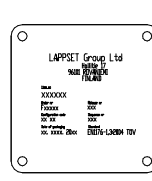
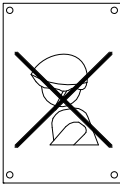
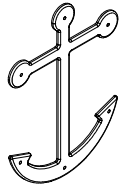
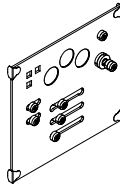
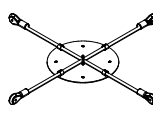
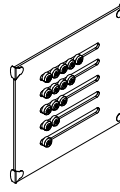

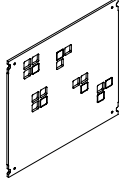
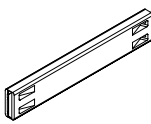
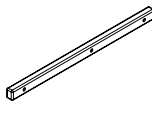
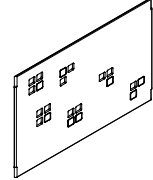
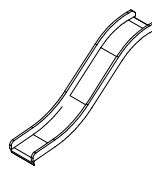
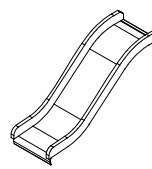
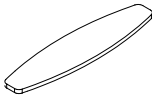
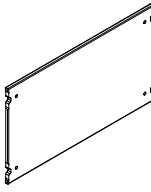
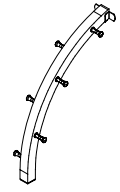
ASENNUSOHJE
MONTERINGSANSVISNING
INSTALLATION INSTRUCTION
AUFBAUANLEITUNG
NOTICE D'INSTALLATION

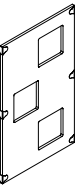
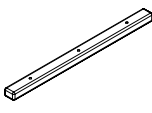
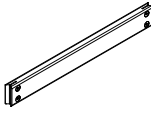

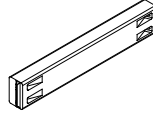

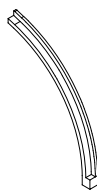

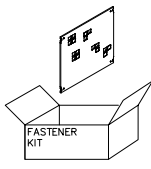
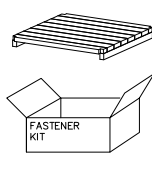
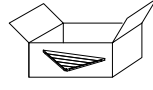
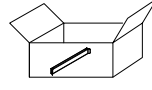
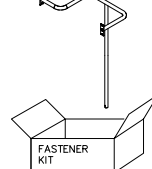
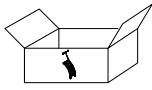
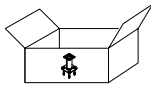
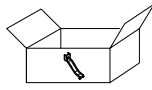
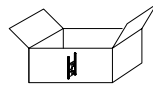

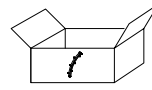

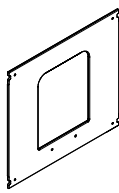
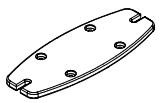
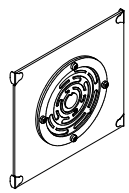
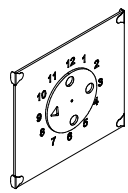
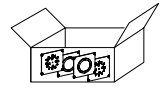

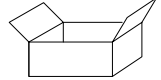

DATE: 17.1.2020

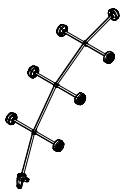
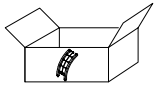
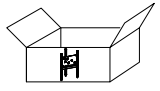
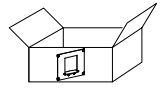
Q10735-3

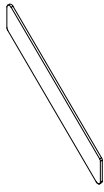
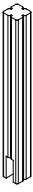

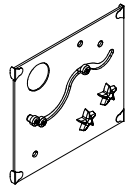
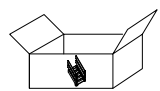
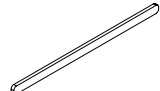
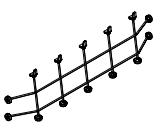
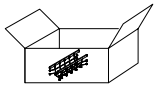
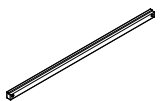
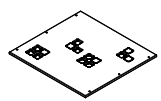
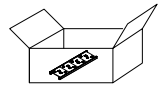
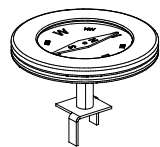
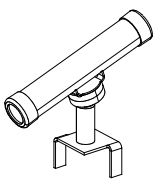
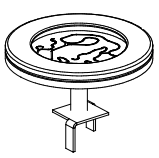
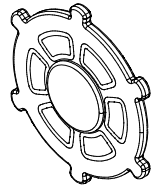

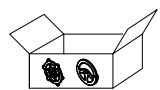
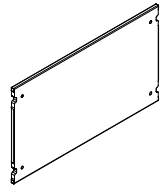
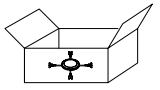
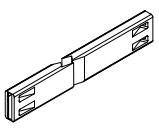
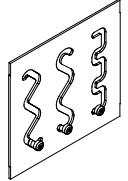
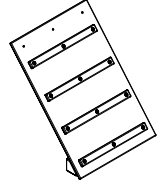
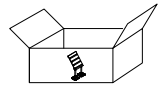





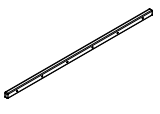
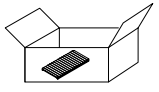
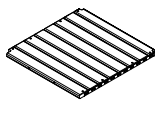
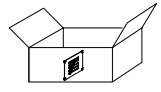
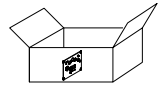
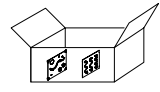
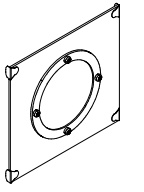
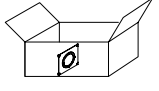
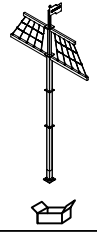

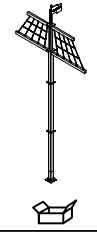
DATE: 17.1.2020

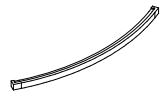

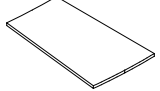
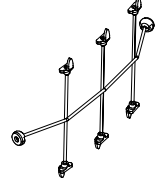
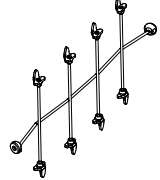
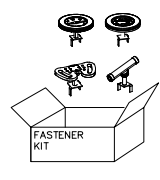
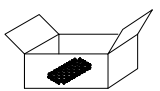
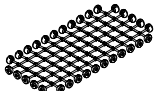
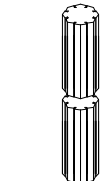
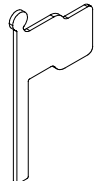
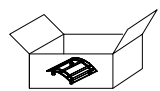

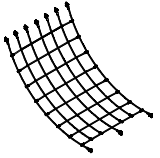

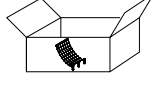
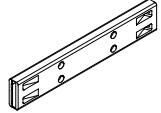
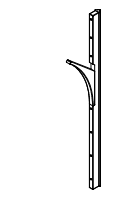
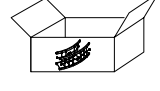
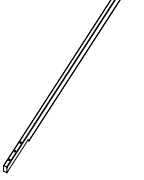
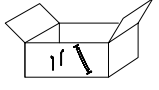
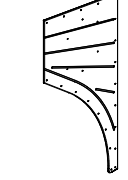
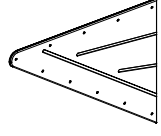
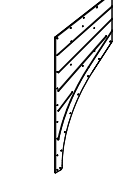
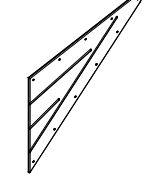
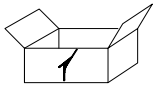
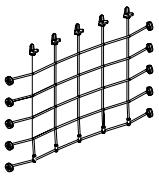
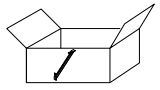
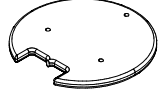
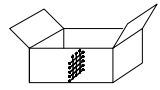
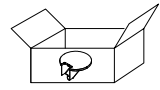



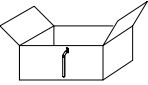
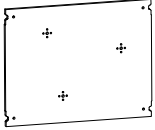
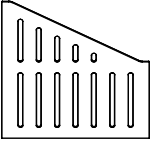
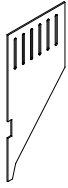
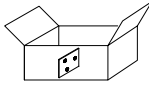
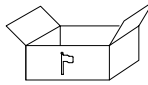
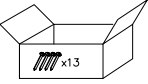
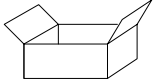
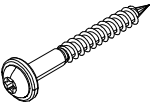
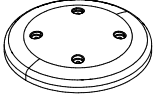
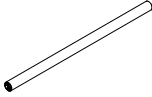
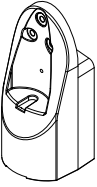

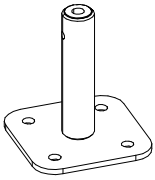
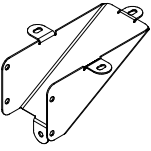

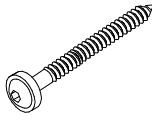
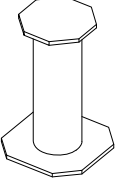
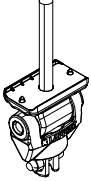
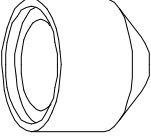
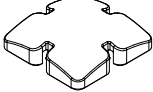
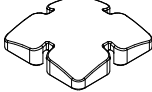
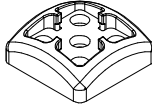
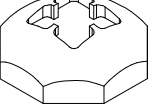
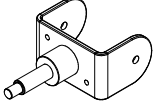
008985  32x714x714	PCS 15	008986  750x750	PCS 40	701088  45x645x1670	PCS 1	701092  15x120x700	PCS 1	701665  45x95x555	PCS 1	702286  65x65	PCS 1
702339  118x78	PCS 1	704868-607  12x503x687	PCS 2	705705-707  10x640x702	PCS 1	706059-302  L 926	PCS 1	706308-707  10x640x702	PCS 1	706371-707  15x345x750	PCS 4
706436-707  10x640x702	PCS 40	706439-603  L 704	PCS 114	706443  32x45x702	PCS 82	706448-707  10x640x1003	PCS 13	706450-603  600x381x2685	PCS 1	706452-603  600x780x1740	PCS 1
706453  15x145x600	PCS 5	706461  15x400x703	PCS 2	706475  1387x1020x325	PCS 1	706484-603  93x93x2150	PCS 25	706505  35x70x730	PCS 4	706507-707  15x345x750	PCS 1
706508  32x45x650	PCS 45	706510-603  45x120x1030	PCS 15	706511-603  93x93x1870	PCS 2	706512-603  70x120x704	PCS 2	706518-603  95x1005x1365	PCS 1	706519-603  95x1005x1365	PCS 1
706521-302  L 2080	PCS 1	706534  FASTENER KIT	PCS 48	706535  FASTENER KIT	PCS 40	706537  FASTENER KIT	PCS 15	706538  FASTENER KIT	PCS 15	706541  FASTENER KIT	PCS 1
706544  FASTENER KIT	PCS 1	706551  FASTENER KIT	PCS 83	706553  FASTENER KIT	PCS 2	706558  FASTENER KIT	PCS 1	706568-603  93x93x3000	PCS 8	706607  FASTENER KIT	PCS 1

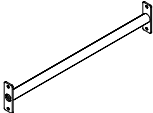
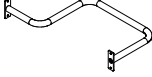
706664-603	PCS 2	706727-707	PCS 1	706744	PCS 1	706766-707	PCS 1	706772-707	PCS 1	706778	PCS 2
											
93x93x2540		10x702x640		15x145x380							
706788-603	PCS 12	706790-603	PCS 1	706810-603	PCS 27	706830	PCS 1	706871-603	PCS 1	706872-603	PCS 1
											
93x93x3700		93x93x3500		93x93x2650				95x1005x1365		95x1005x1365	
706873-302	PCS 1	706877	PCS 1	706878	PCS 13	706885	PCS 1	707113-302	PCS 1	707145-603	PCS 2
											
1455x505										43x93x717	
707146-707	PCS 4	707154-603	PCS 14	707191-603	PCS 1	707209-707	PCS 1	707224	PCS 1	707255-609	PCS 2
											
15x145x1153		93x93x900		+870		10x640x702				45x120x2480	
707260-302	PCS 2	707268	PCS 1	707271-603	PCS 2	707272-707	PCS 4	707284	PCS 1	707303-705	PCS 1
											
2375x600				70x95x2480		15x630x590					
707304	PCS 1	707305-705	PCS 1	707320-705	PCS 1	707331-603	PCS 2	707333	PCS 1	707340	PCS 4
											
						93x93x470				15x300x702	
707373	PCS 1	707374-603	PCS 15	707386-707	PCS 1	707418-707	PCS 1	707419	PCS 1	707436	PCS 1
											
		L 1504		10x640x702		700x1000				750x770	

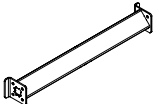
DATE: 17.1.2020

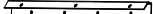
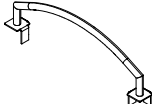
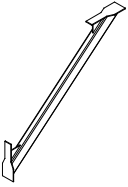
707437  32x45x1502	PCS 1	707440  750x770	PCS 1	707441 	PCS 1	707446 	PCS 1	707449 	PCS 1	707450 	PCS 2
707453-707  10x640x702	PCS 16	707454 	PCS 16	707480  	PCS 2	707481  	PCS 1	707518-603 	PCS 2	707519-603 	PCS 2
707520-603 	PCS 2	707521-603 	PCS 2	707522-704 	PCS 24	707525-302 	PCS 4	707528-302 	PCS 4	707585  FASTENER KIT	PCS 3
707589 	PCS 1	707595-302  755x1555	PCS 1	707597-603  140x140x450	PCS 3	707621-610  21x489x900	PCS 1	707623 	PCS 5	707626-603  L 890	PCS 1
707630-302  1600x2810	PCS 1	707634-603  90x145x3233	PCS 1	707635 	PCS 1	707637-603  45x120x704	PCS 2	707643-603  125x793x3700	PCS 1	707644 	PCS 2
707646-603  90x145x4073	PCS 1	707652 	PCS 1	707657-603  15x2239x1000	PCS 1	707658-603  15x1000x721	PCS 1	707660-603  15x2239x1000	PCS 1	707661-603  15x1000x721	PCS 1
707685 	PCS 1	707686-302  1350x1240	PCS 4	707695 	PCS 2	707696-704  15x265x275	PCS 1	707699 	PCS 4	707729 	PCS 1

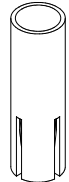
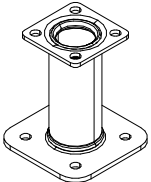
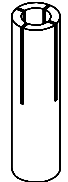
DATE: 17.1.2020

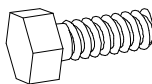
707732  30	PCS 30	707735-707  15x702x550	PCS 2	2	707744-707  2	PCS 2	2	707746-609  2	PCS 2	2	707774  2	PCS 2	2	707839  1	PCS 1	1	
707840  2	PCS 2	707914  2	PCS 2	2	900240  Ø8x70	PCS 28	28	900733  Ø450x83	PCS 1	1	901868  Ø34x598	PCS 2	2	901879  4	PCS 4	4	
901902  30.7x60.9x100	PCS 4	4	901920  150x130x130	PCS 1	1	902086  148x172x254	PCS 1	1	902439  Left Hand	PCS 1	1	902474  Right Hand	PCS 1	1	903093  Ø8x90	PCS 534	534
903100  180x180x280	PCS 3	3	904904  2	PCS 2	2	905104  M10	PCS 24	24	905138  GRAY	PCS 69	69	905139  69x69x20	PCS 3	3	905196  GRAY	PCS 69	69
905197  147x147x56.5	PCS 3	3	905879  1	PCS 1	1	907688-216  40x765x114	PCS 12	12	907694-216  L 704	PCS 8	8	907695-216  1	PCS 1	1	907701-216  20	PCS 20	20
907817-216  L 2554	PCS 1	1	908226-216  90x96,5x704	PCS 2	2	908251  1100x1100x215	PCS 5	5	908291-216  47x55x696x3	PCS 1	1	908330-216  10	PCS 10	10	908360-216  SUPPORT	PCS 2	2
909349  12x10	PCS 12	12	909509  M12x50	PCS 12	12	909531  130x130x150	PCS 87	87	909545  10x40	PCS 8	8	909628  M10x100	PCS 8	8	909629  10x30	PCS 8	8

DATE: 17.1.2020

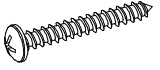
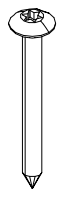
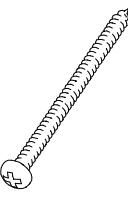
980114	PCS	980128	PCS	980131	PCS		PCS		PCS		PCS
	8		56		288						
Ø4x20		Ø7x40		Ø6x60							
	PCS		PCS		PCS		PCS		PCS		PCS
	PCS		PCS		PCS		PCS		PCS		PCS
	PCS		PCS		PCS		PCS		PCS		PCS
	PCS		PCS		PCS		PCS		PCS		PCS
	PCS		PCS		PCS		PCS		PCS		PCS

EN/AS Impact Area 205.4 m²
Grid Size 1000 mm

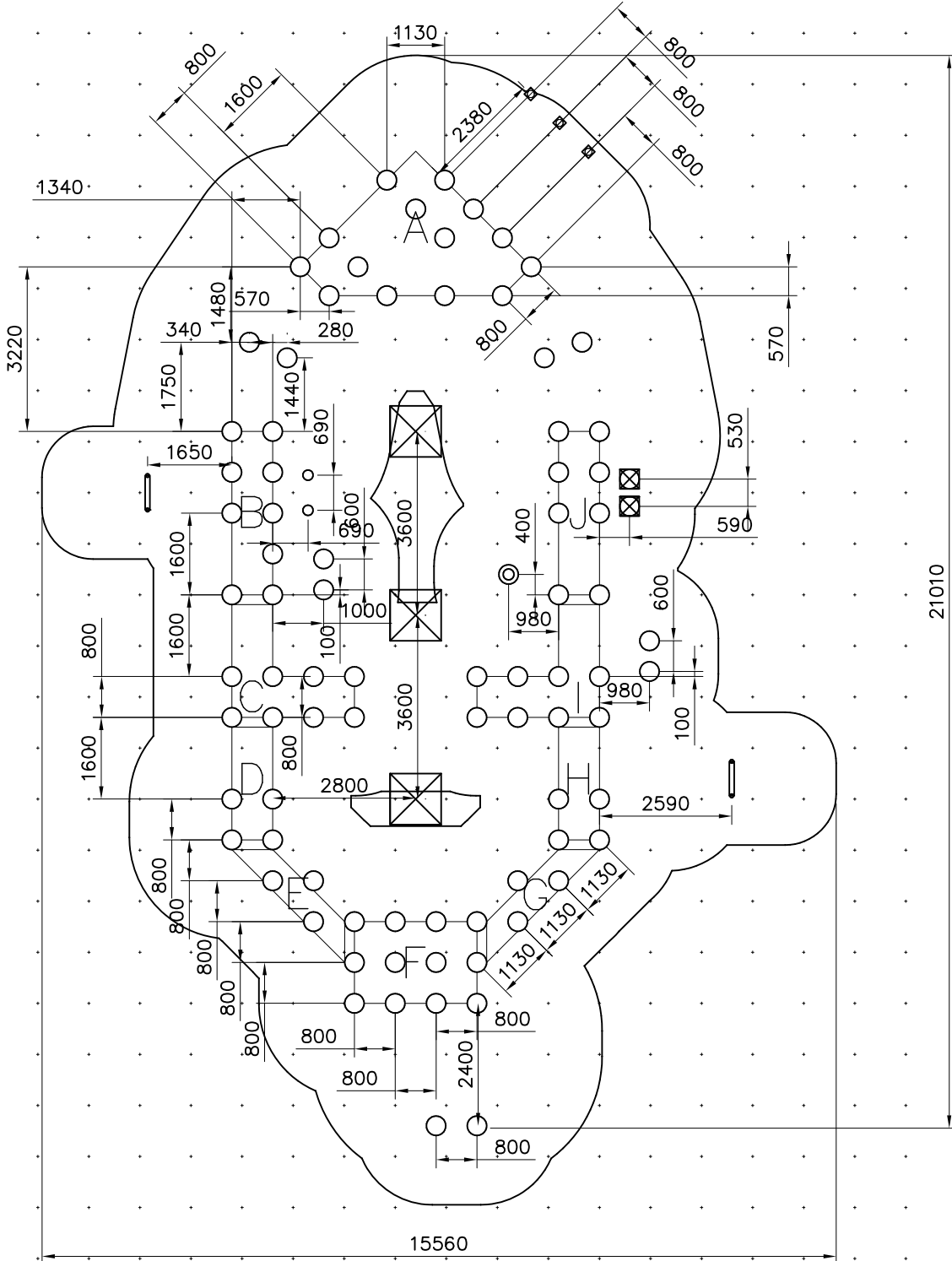
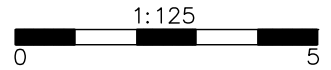

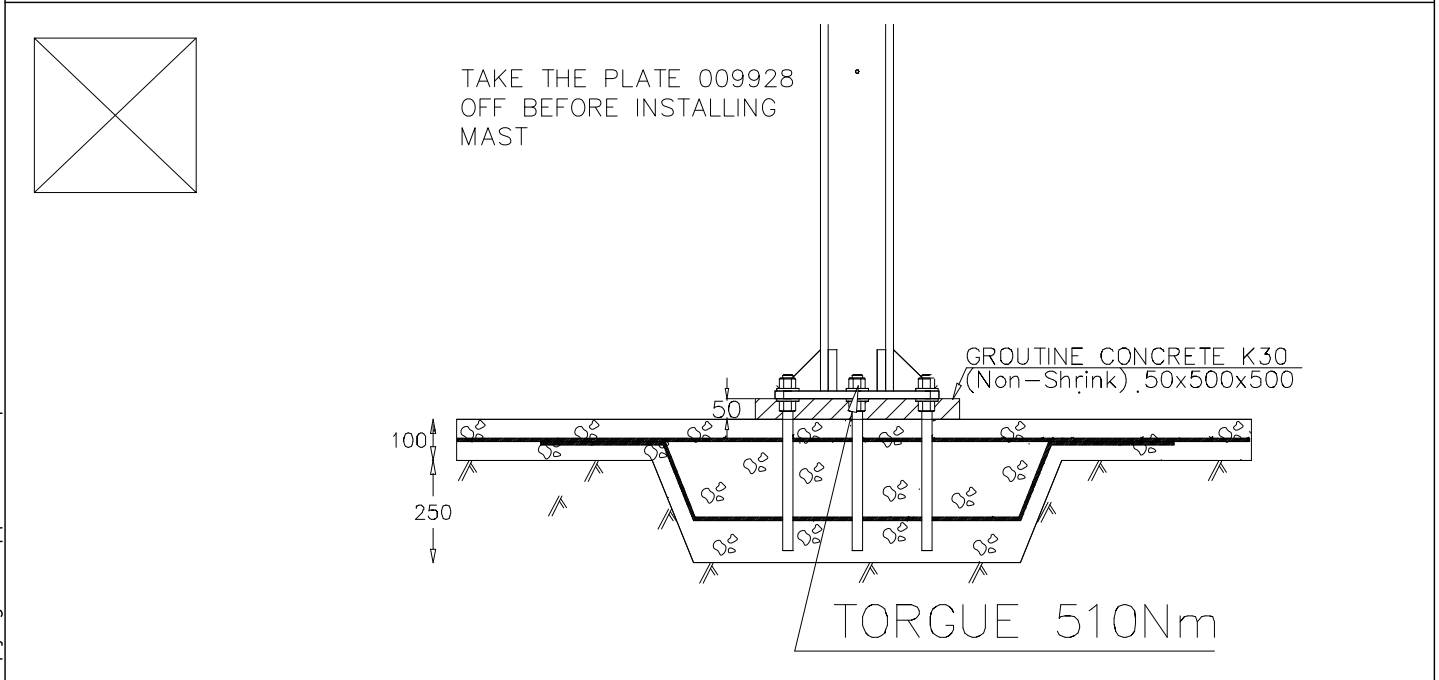
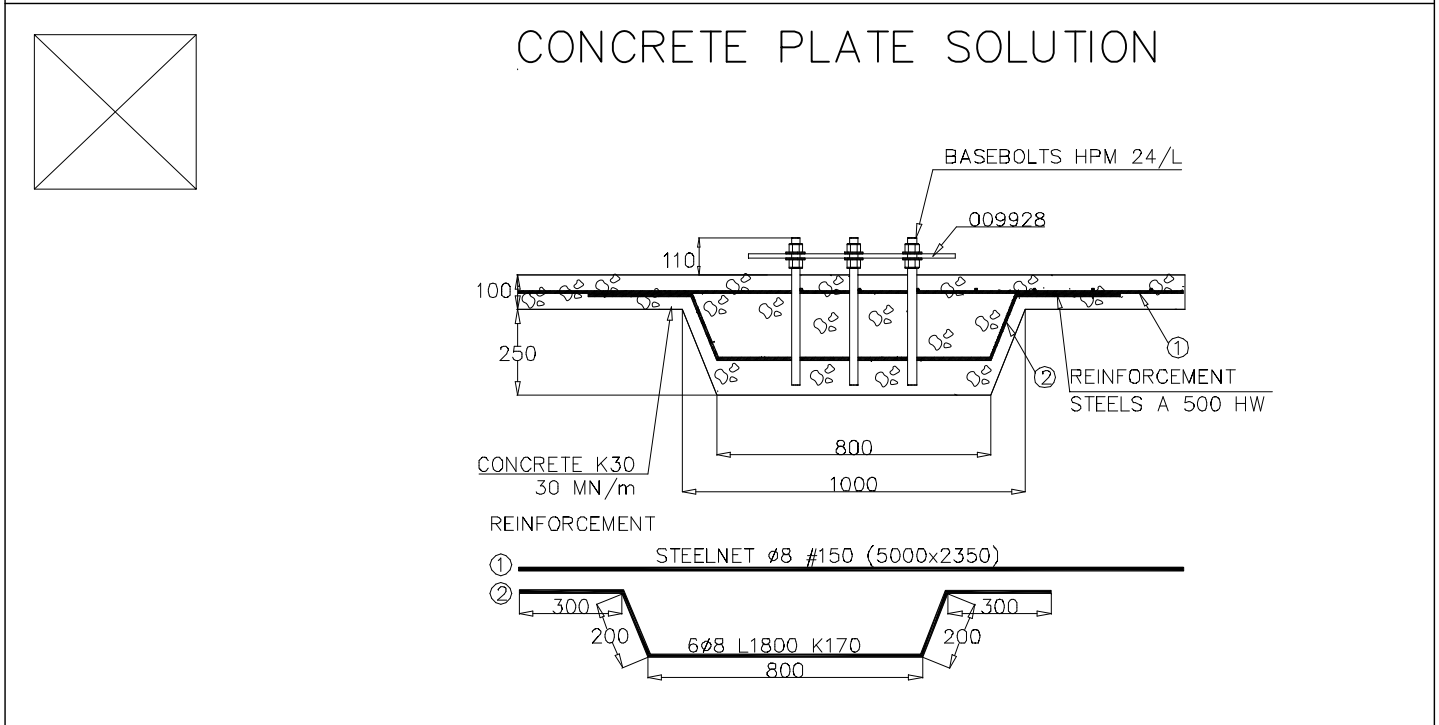
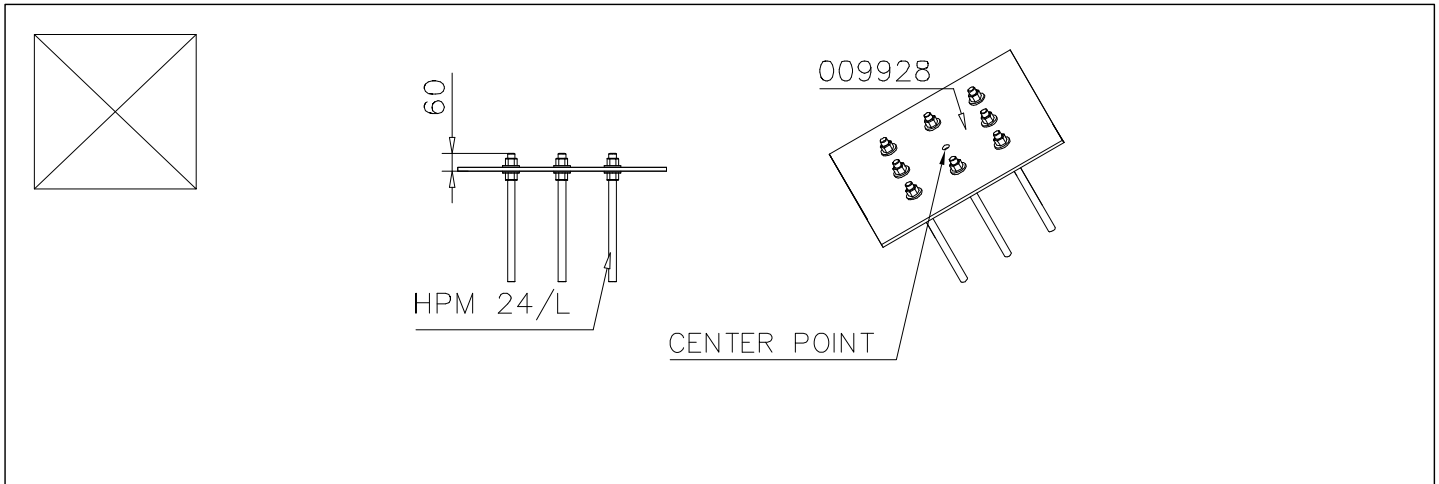

OPTION 2 CONCRETE BLOCK SOLUTION

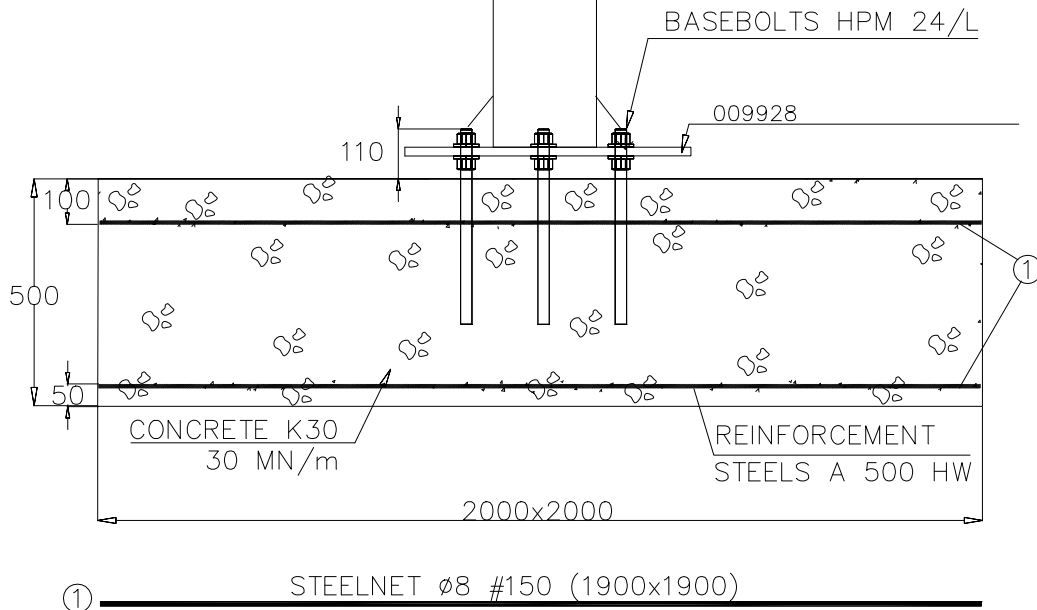
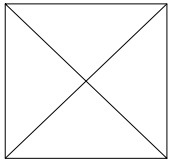

OPTION 2 CONCRETE BLOCK SOLUTION

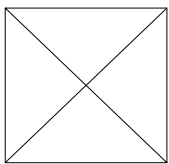

TAKE THE PLATE 009928
OFF BEFORE INSTALLING
MAST

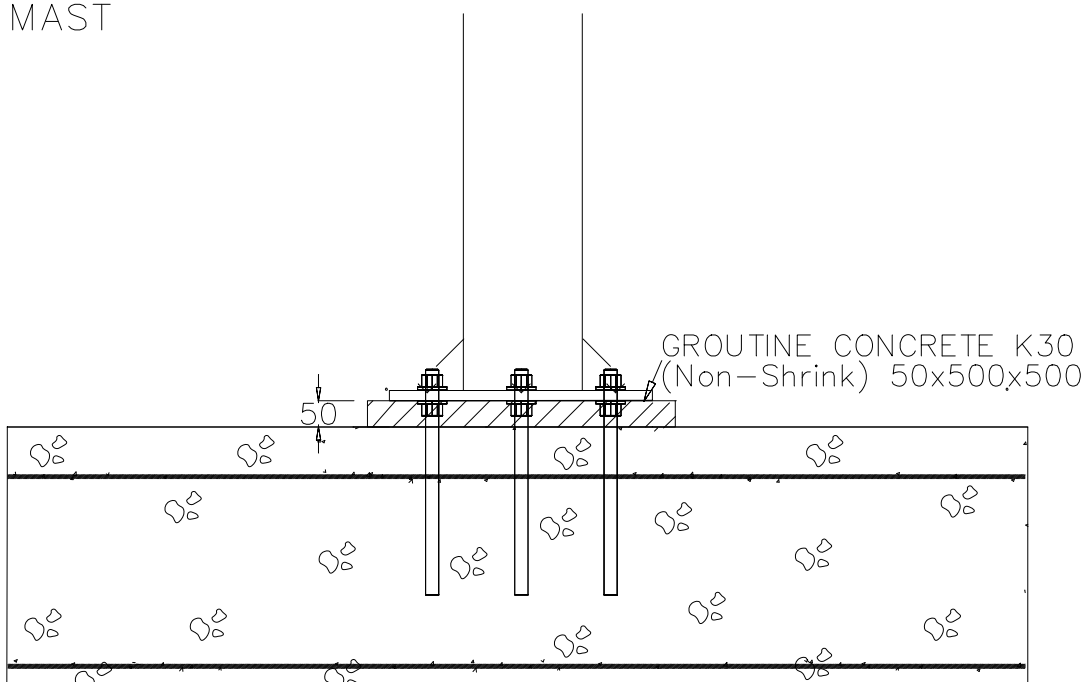

EN/AS Impact Area 205.4 m²

Falling Space 242 m²

Max Falling Height 2950 mm

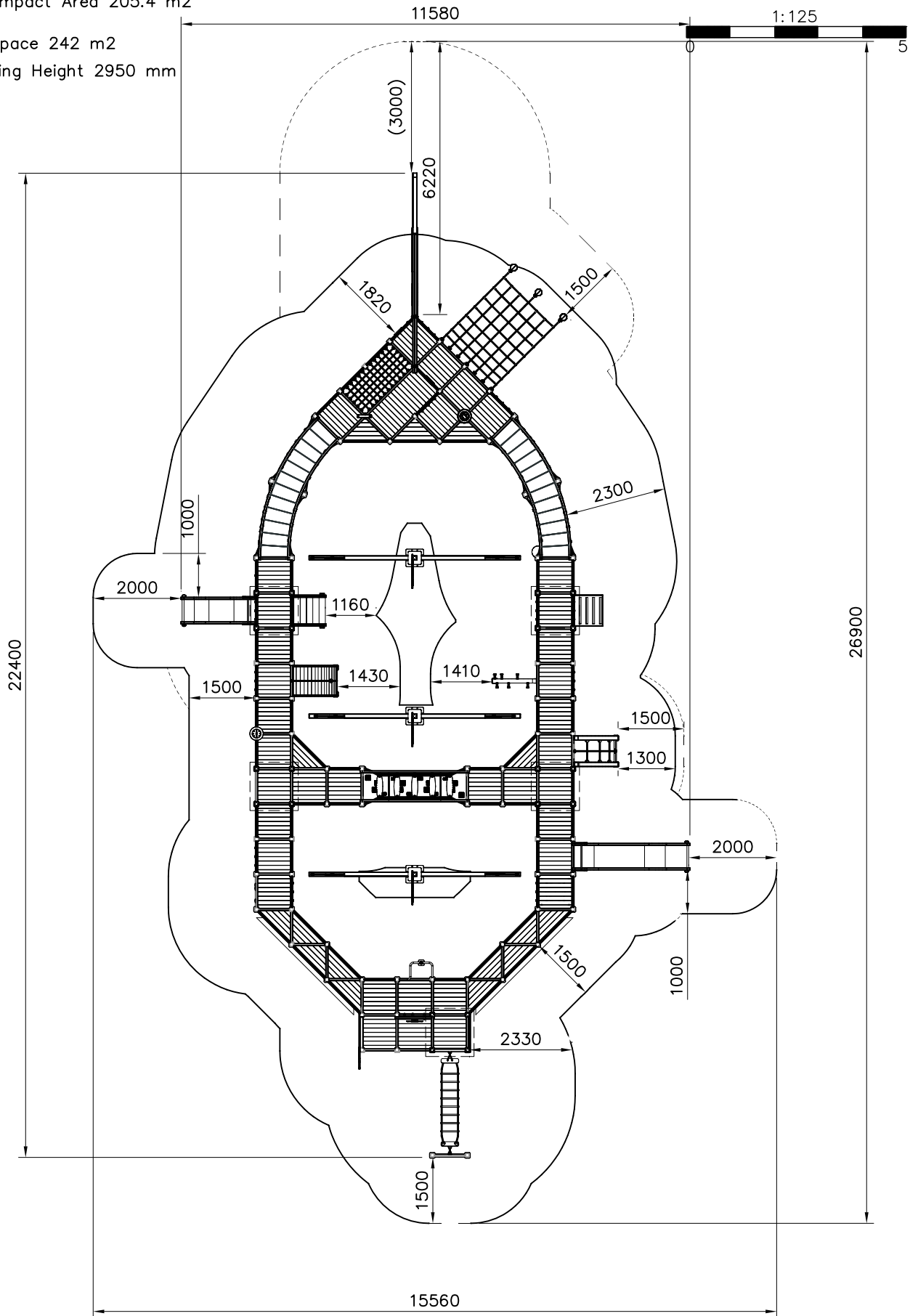

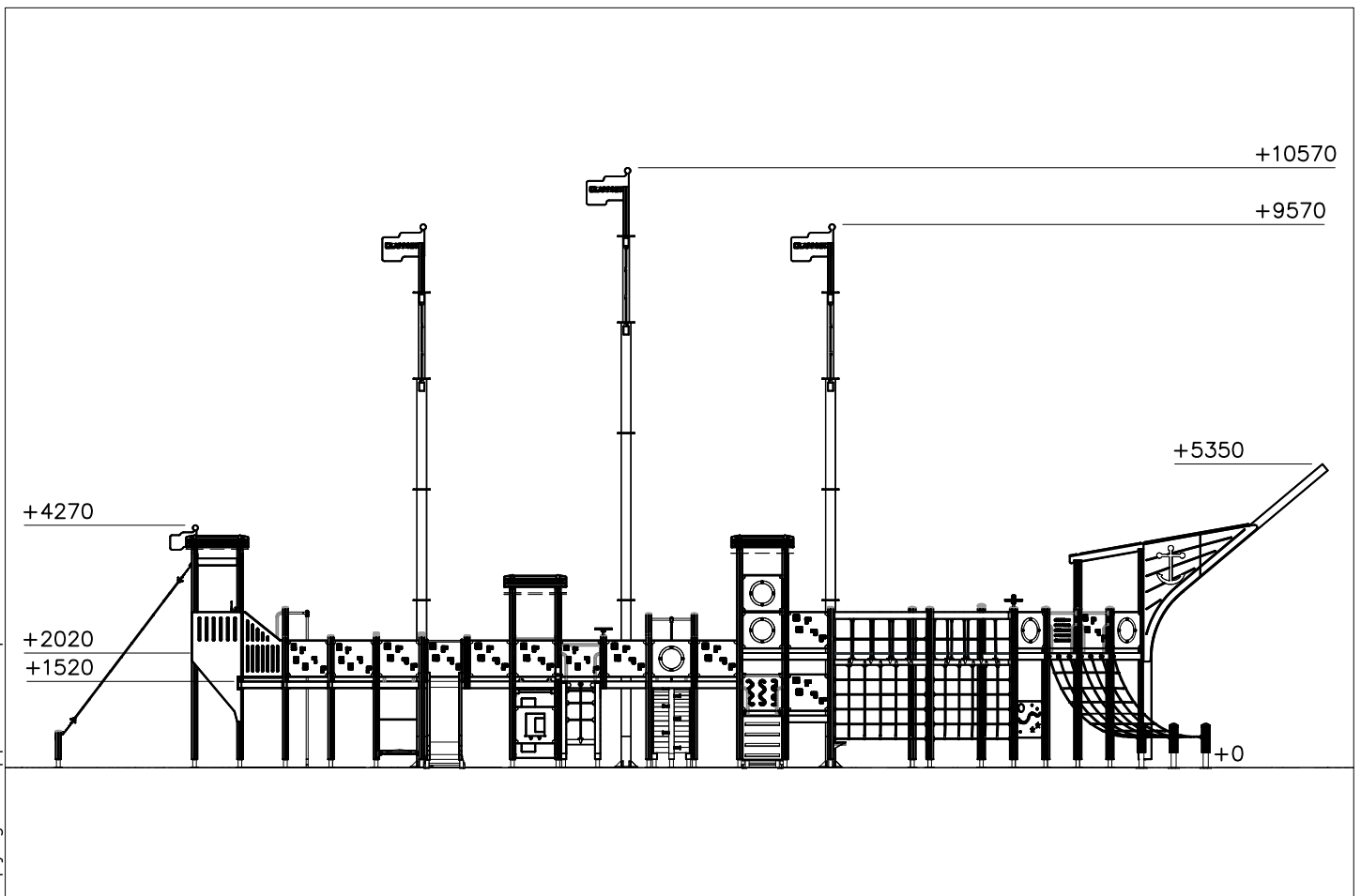
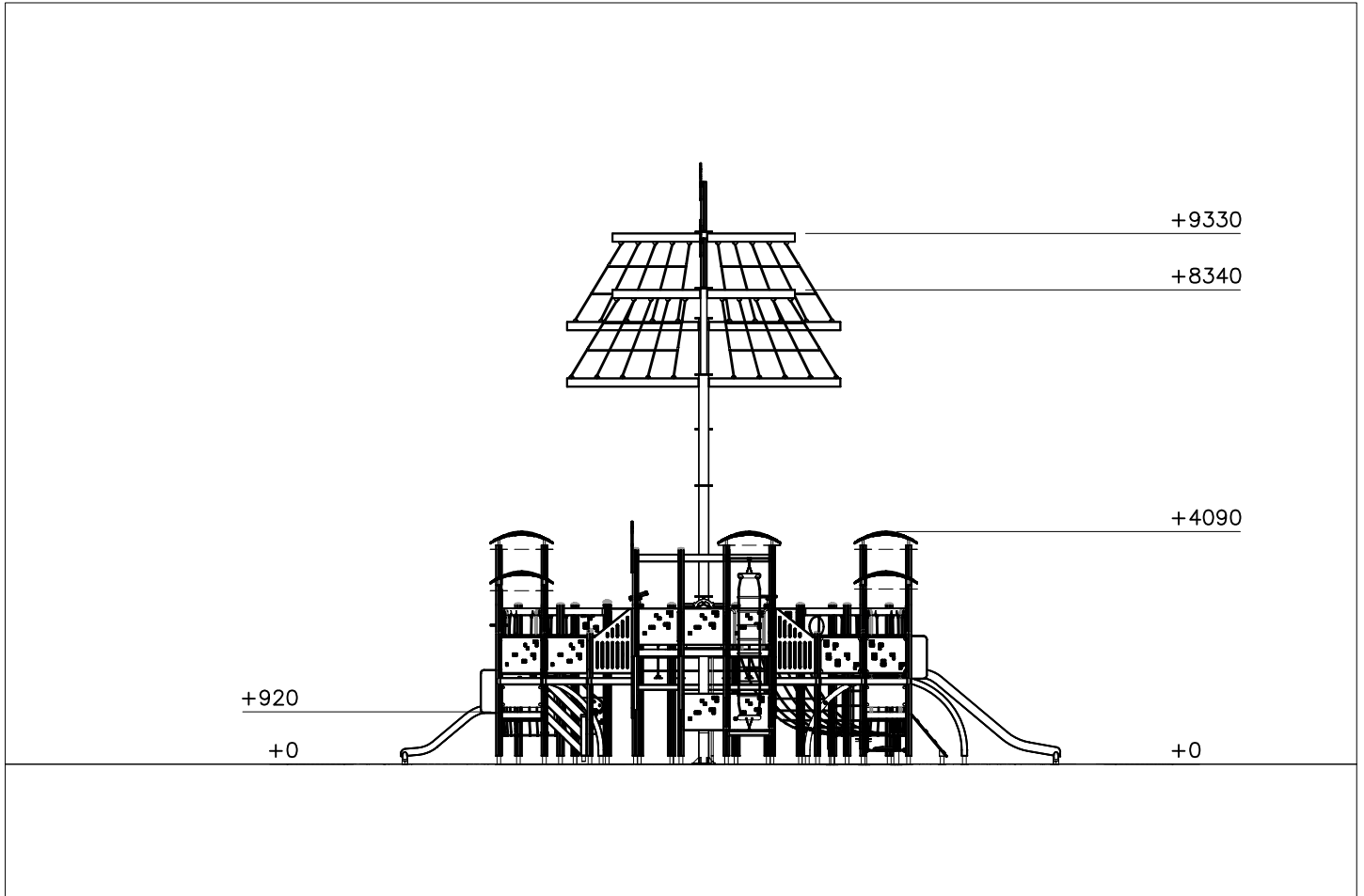

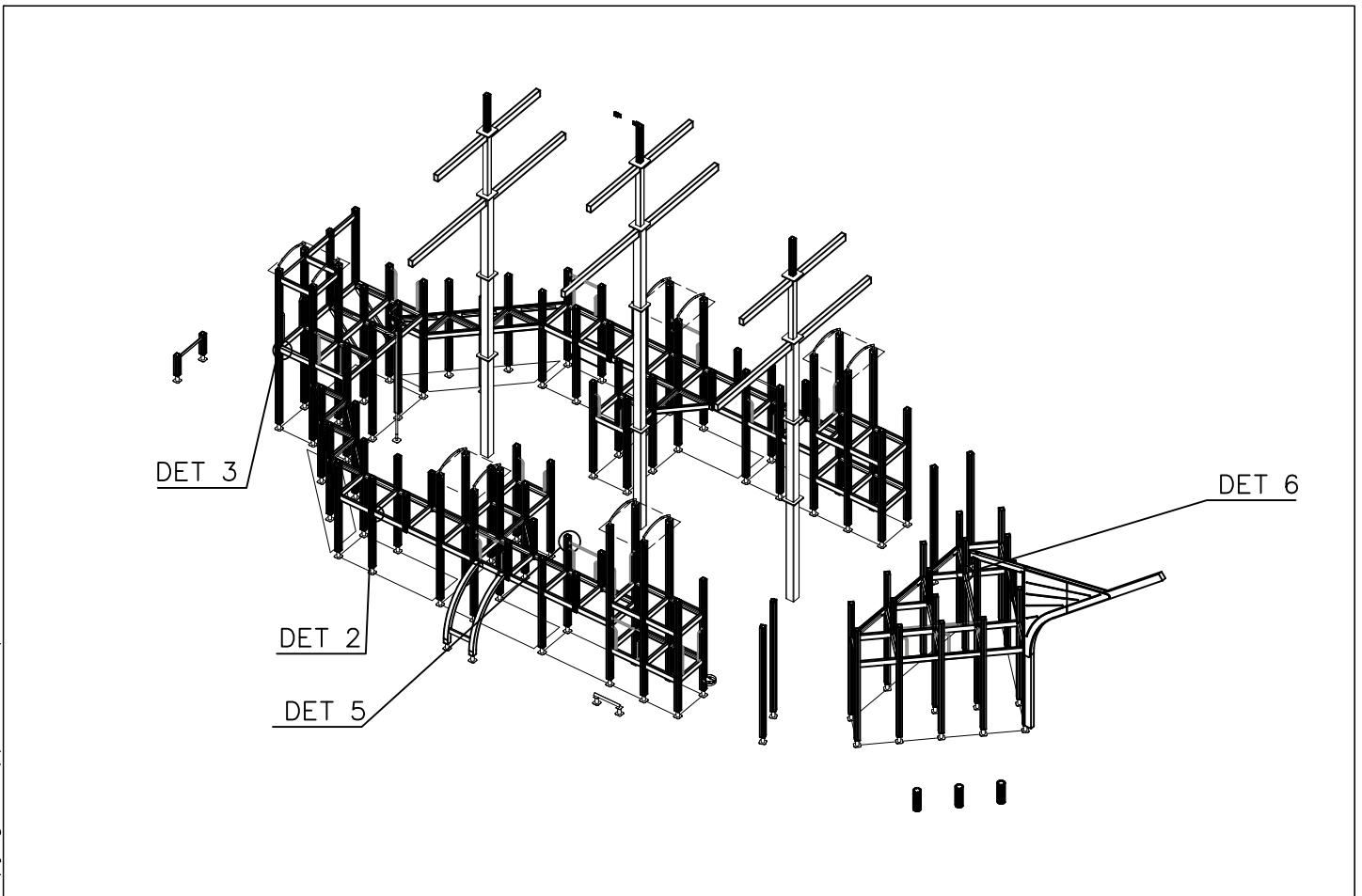
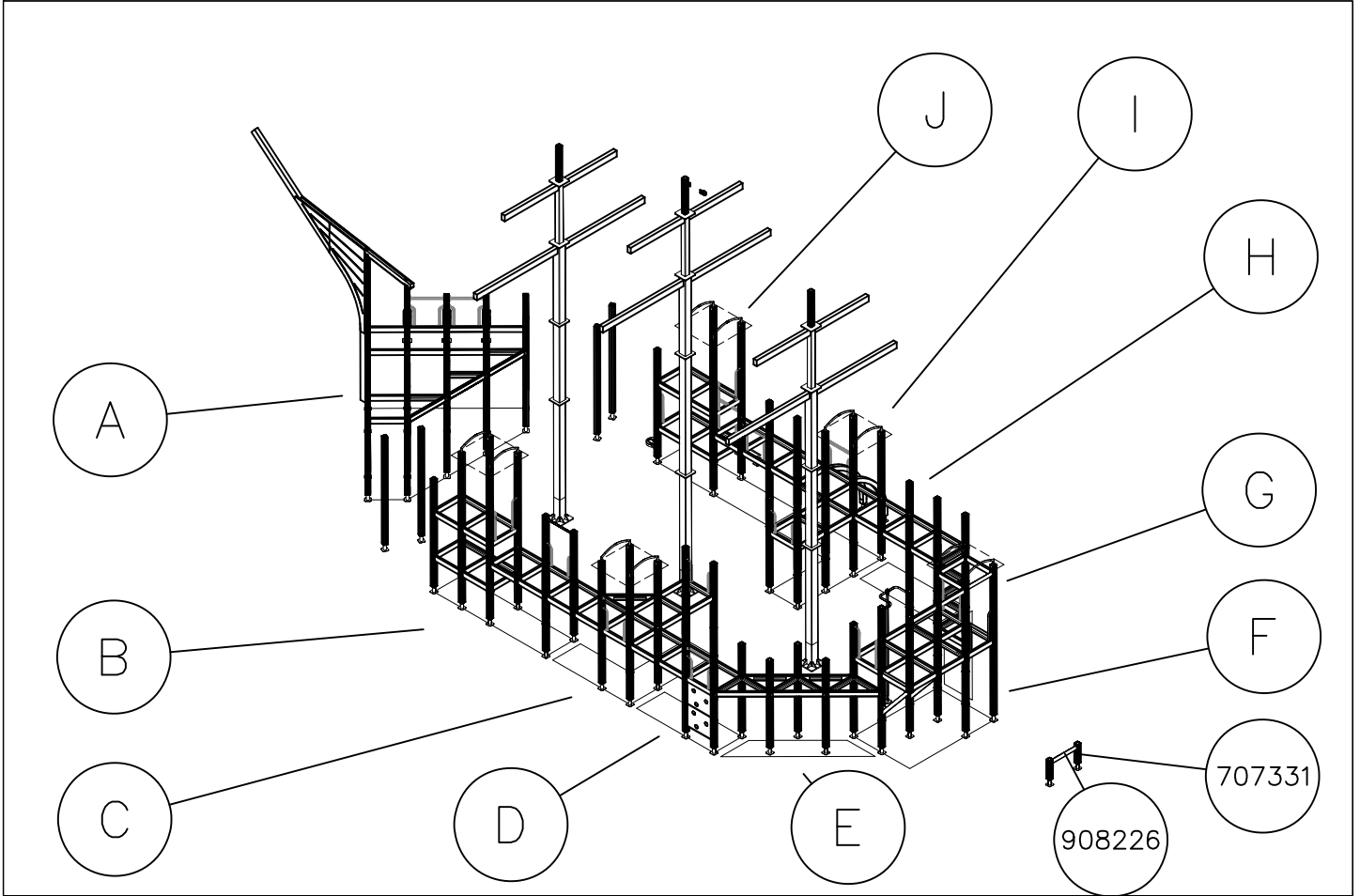

<p>DET 1</p> <p>905138 Ø6x60 (980131) 905196</p>	<p>DET 2</p> <p>Ø8x90 (903093)</p>	<p>DET 3</p> <p>Ø8x90 (903093)</p>	<p>DET 4</p> <p>Ø8x90 (903093) 707626</p>
<p>DET 5</p> <p>PRE-DRILL HOLE. Ø5 ↓ 40 907694 Ø8x70 (900240)</p>	<p>DET 6</p> <p>Ø7x40 (980128)</p>		

DATE: 17.1.2020

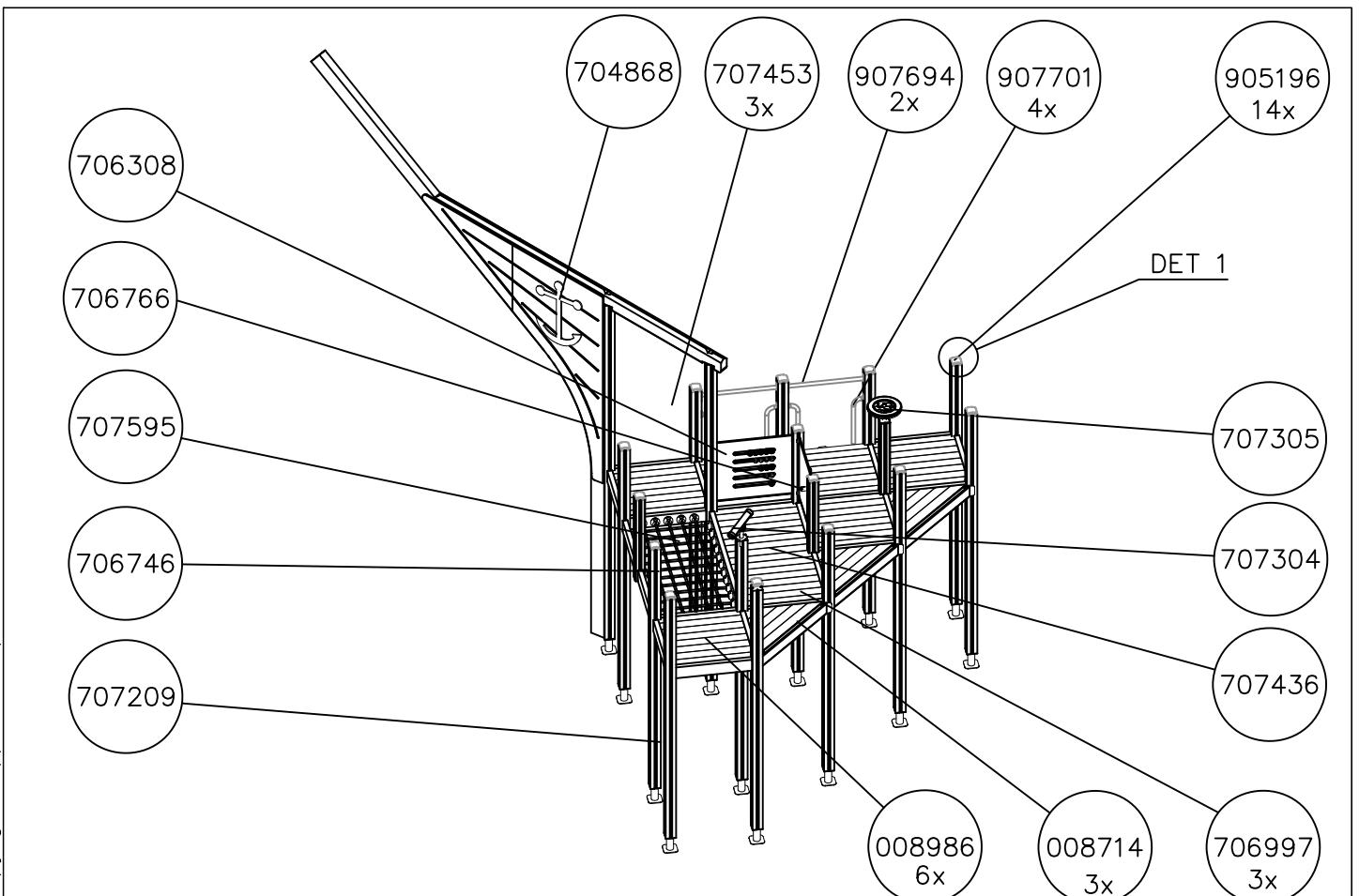
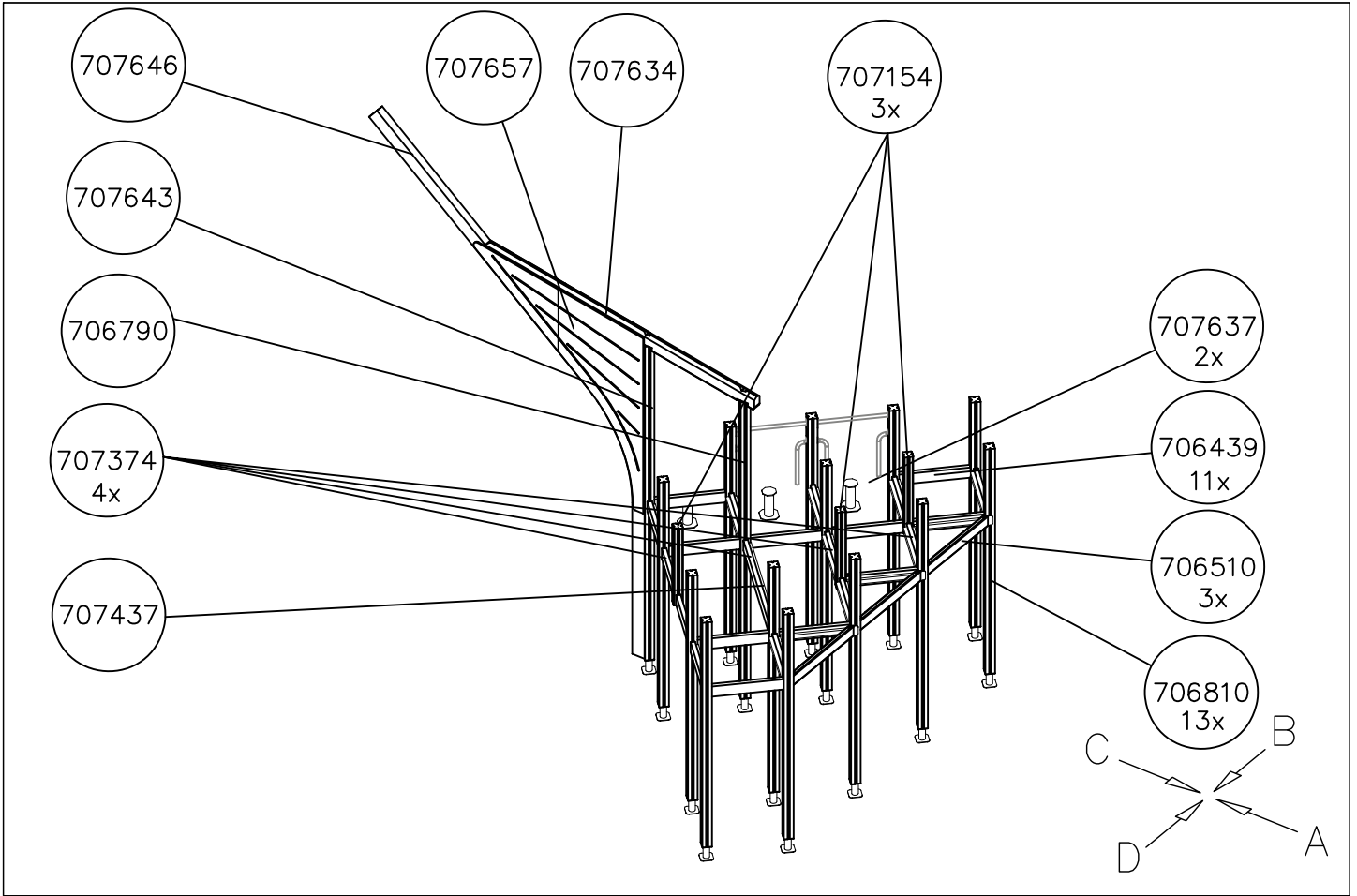

DATE: 17.1.2020

1:50

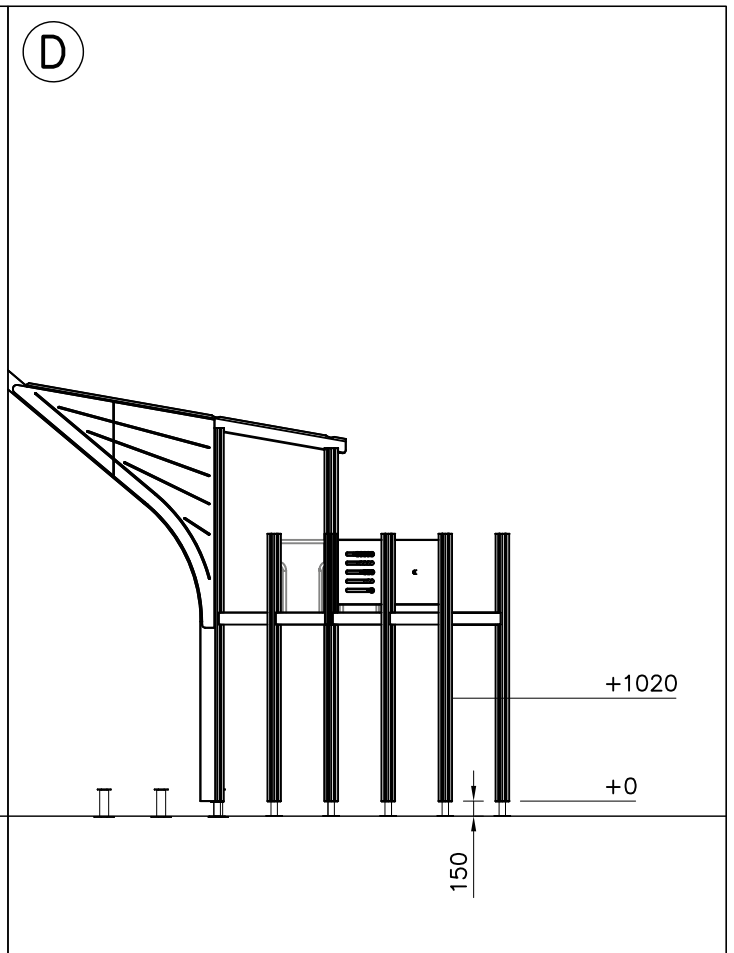
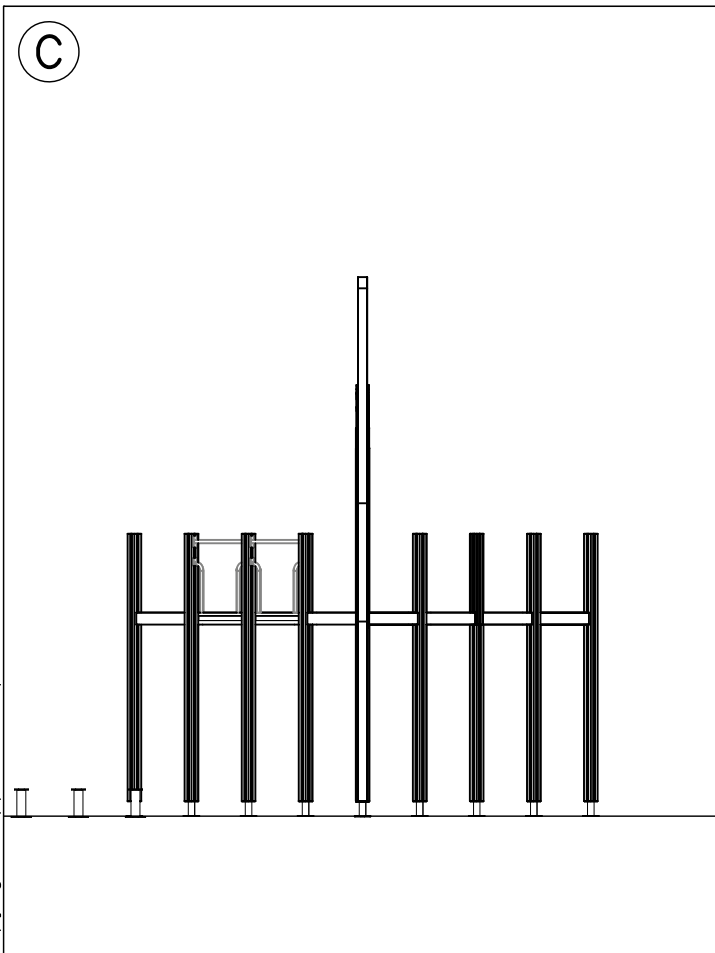
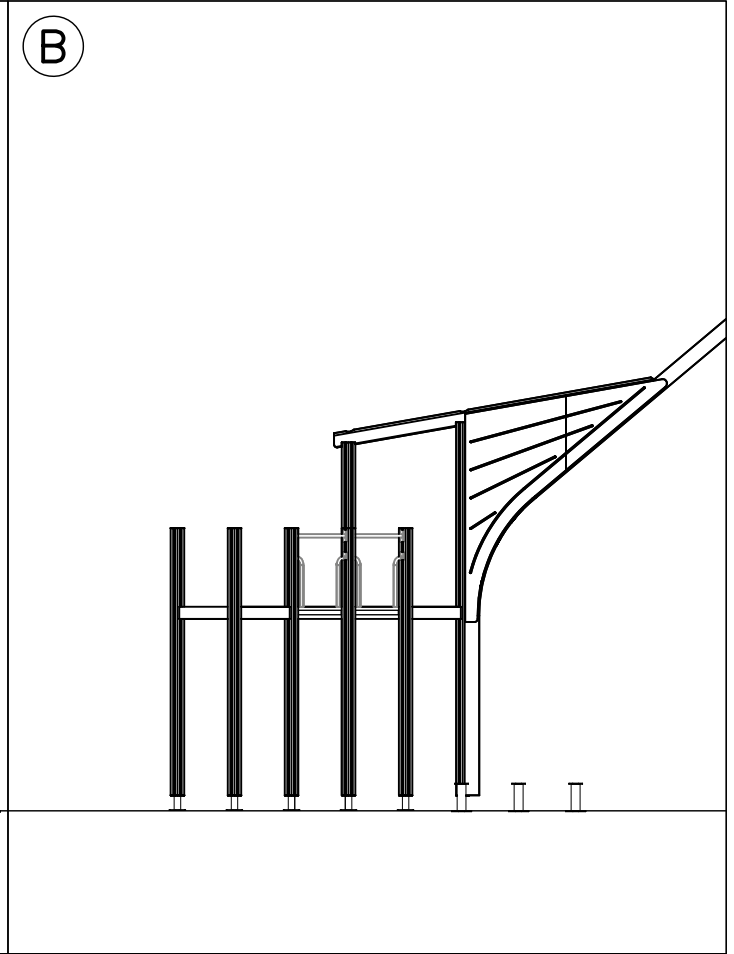
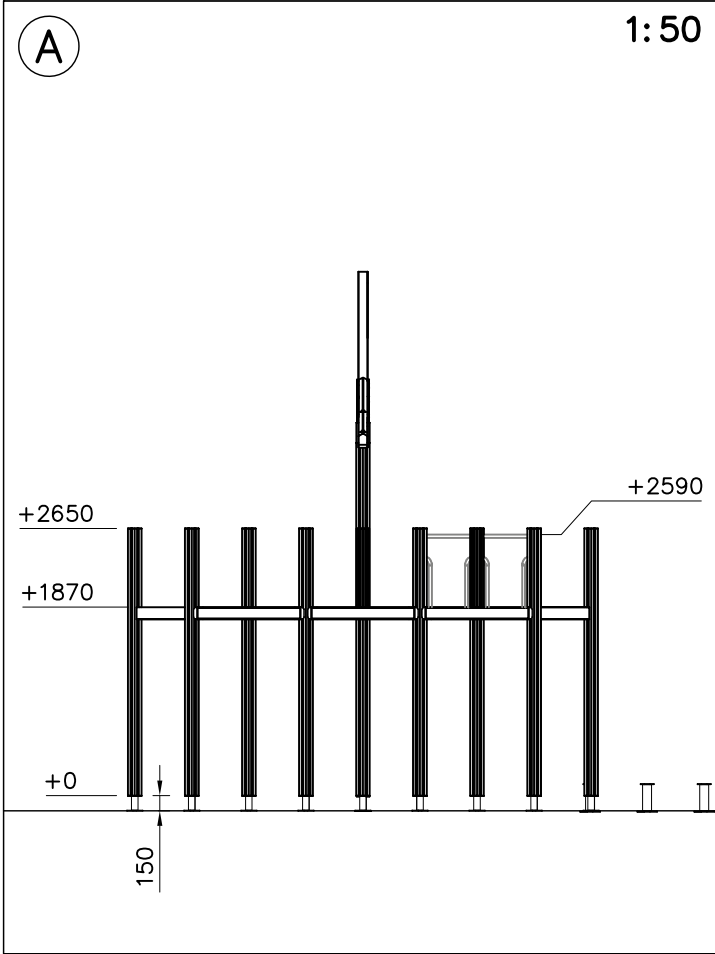

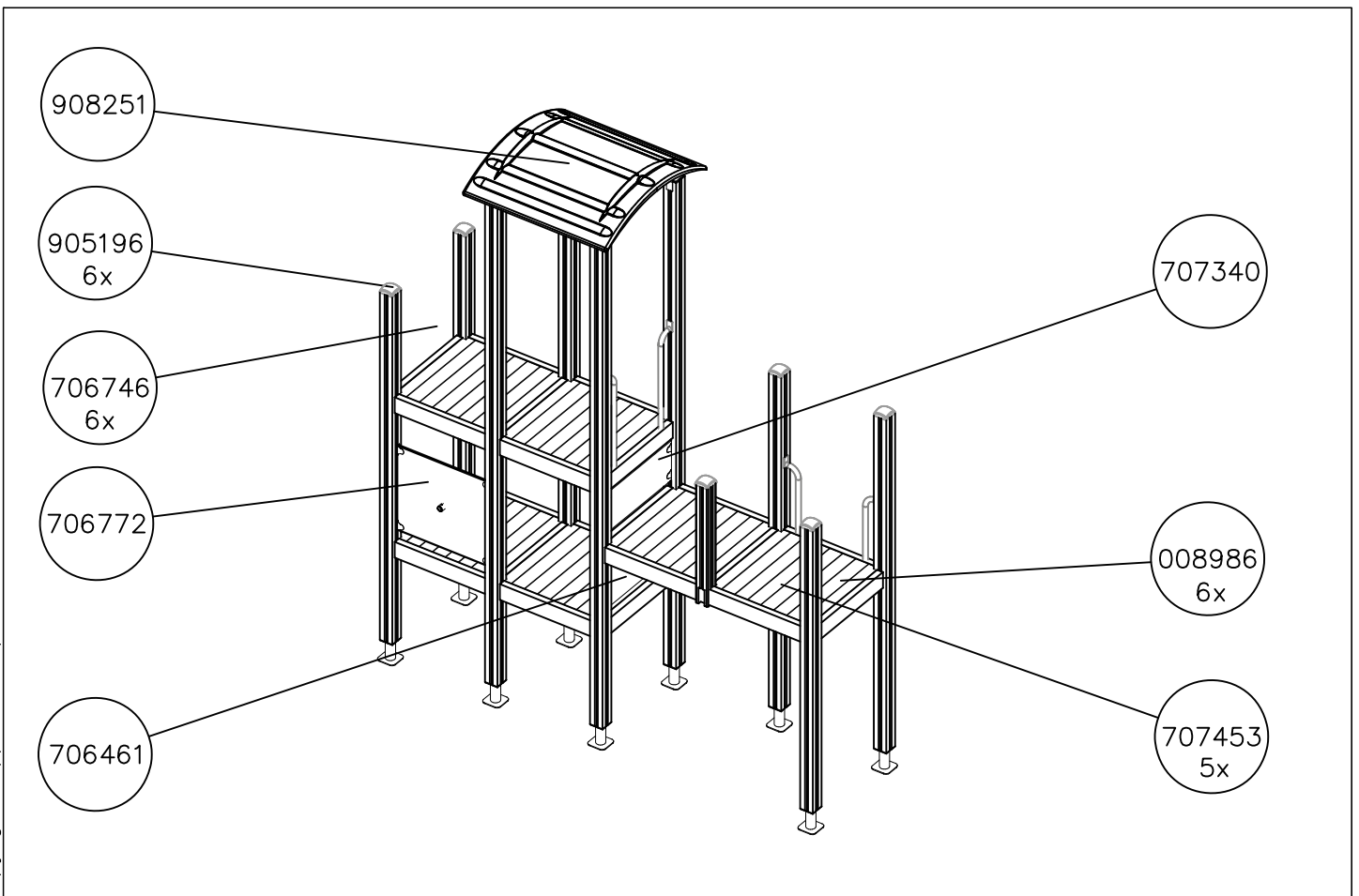
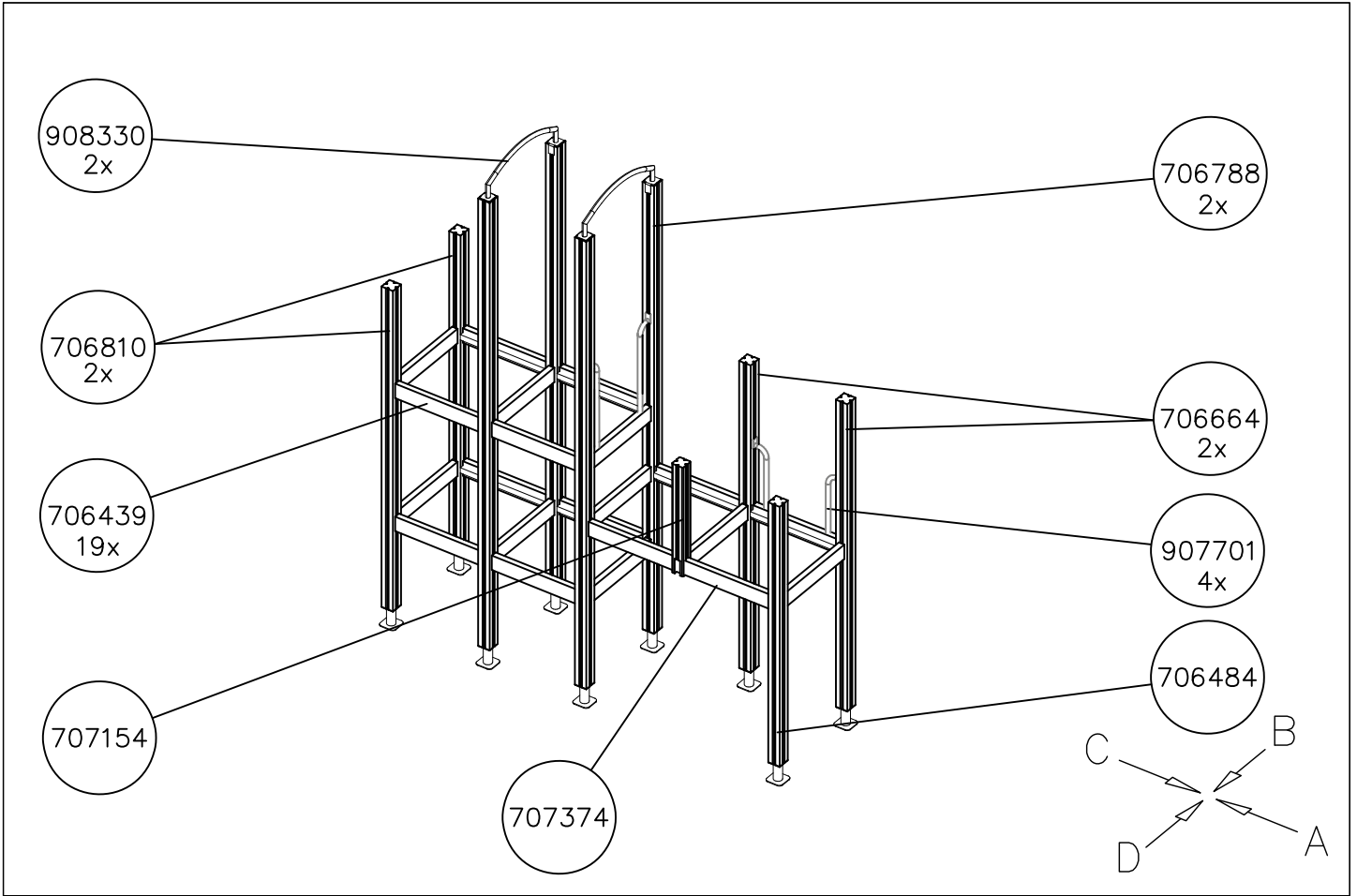

DATE: 17.1.2020

1:50

A

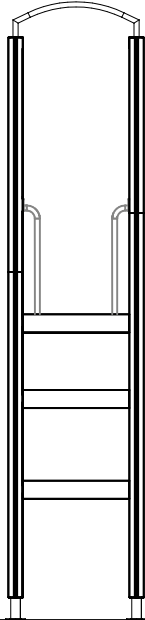

B

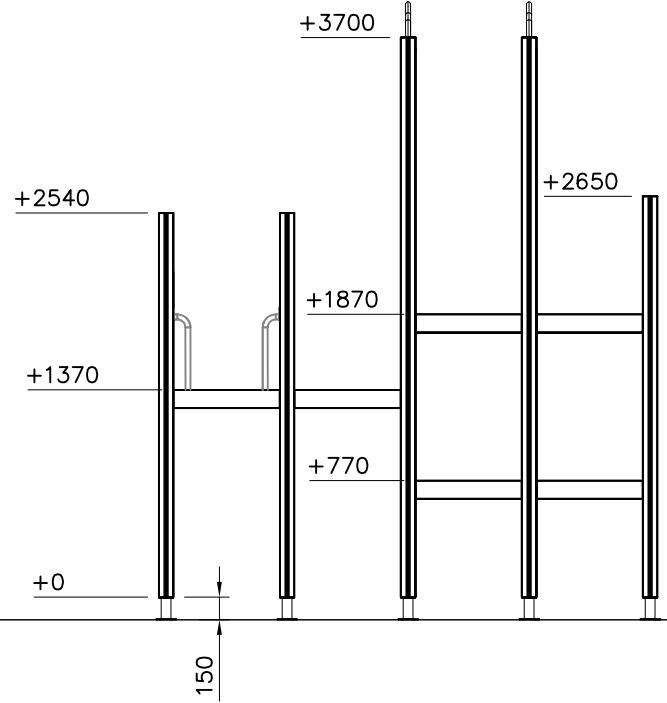

C

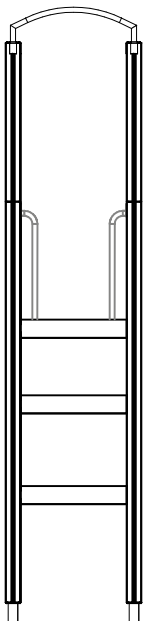

D

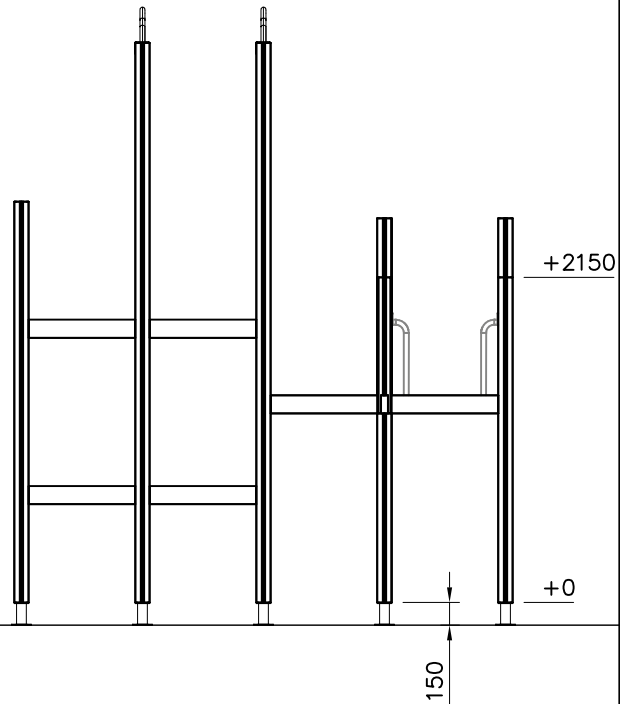

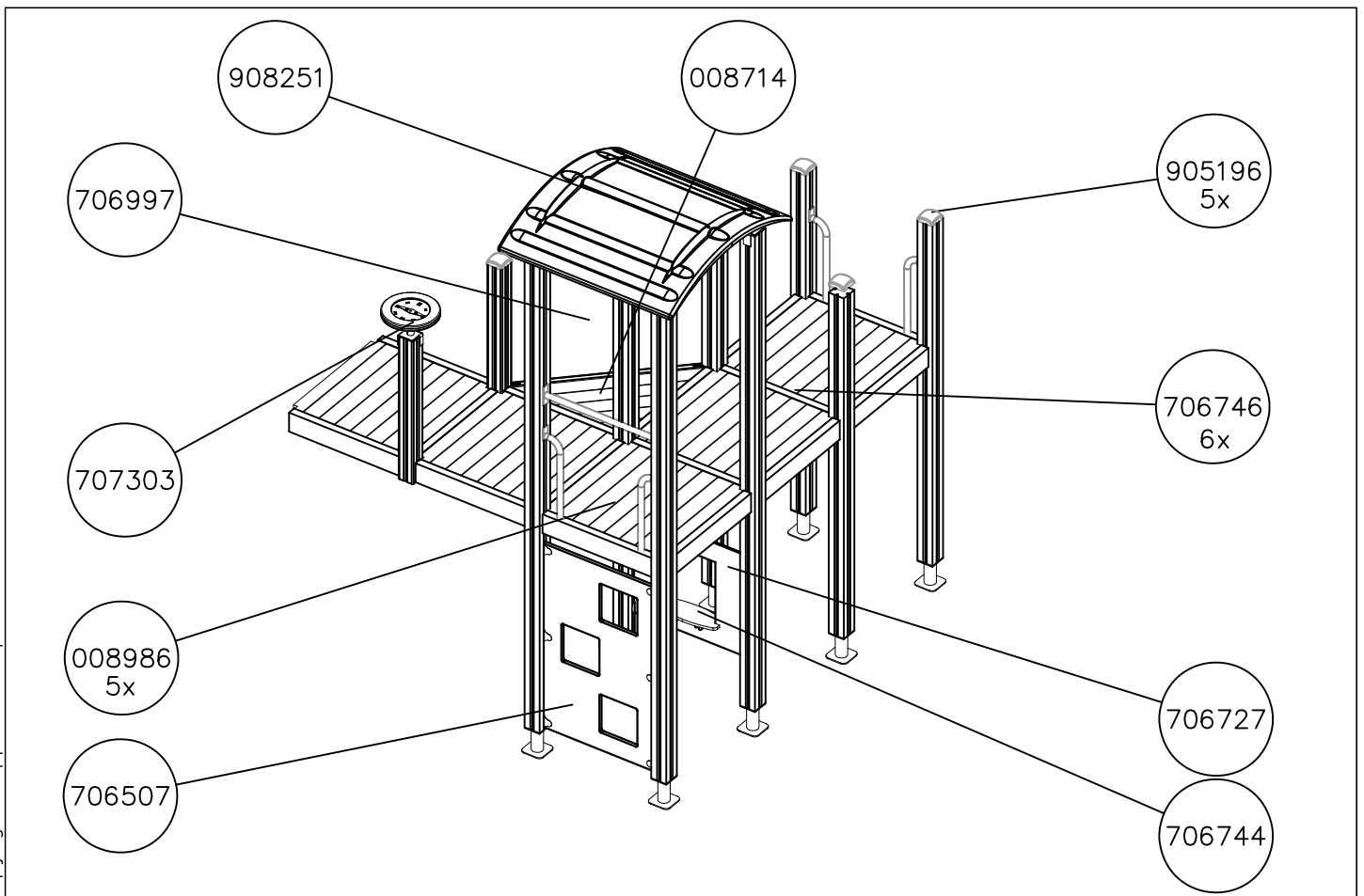
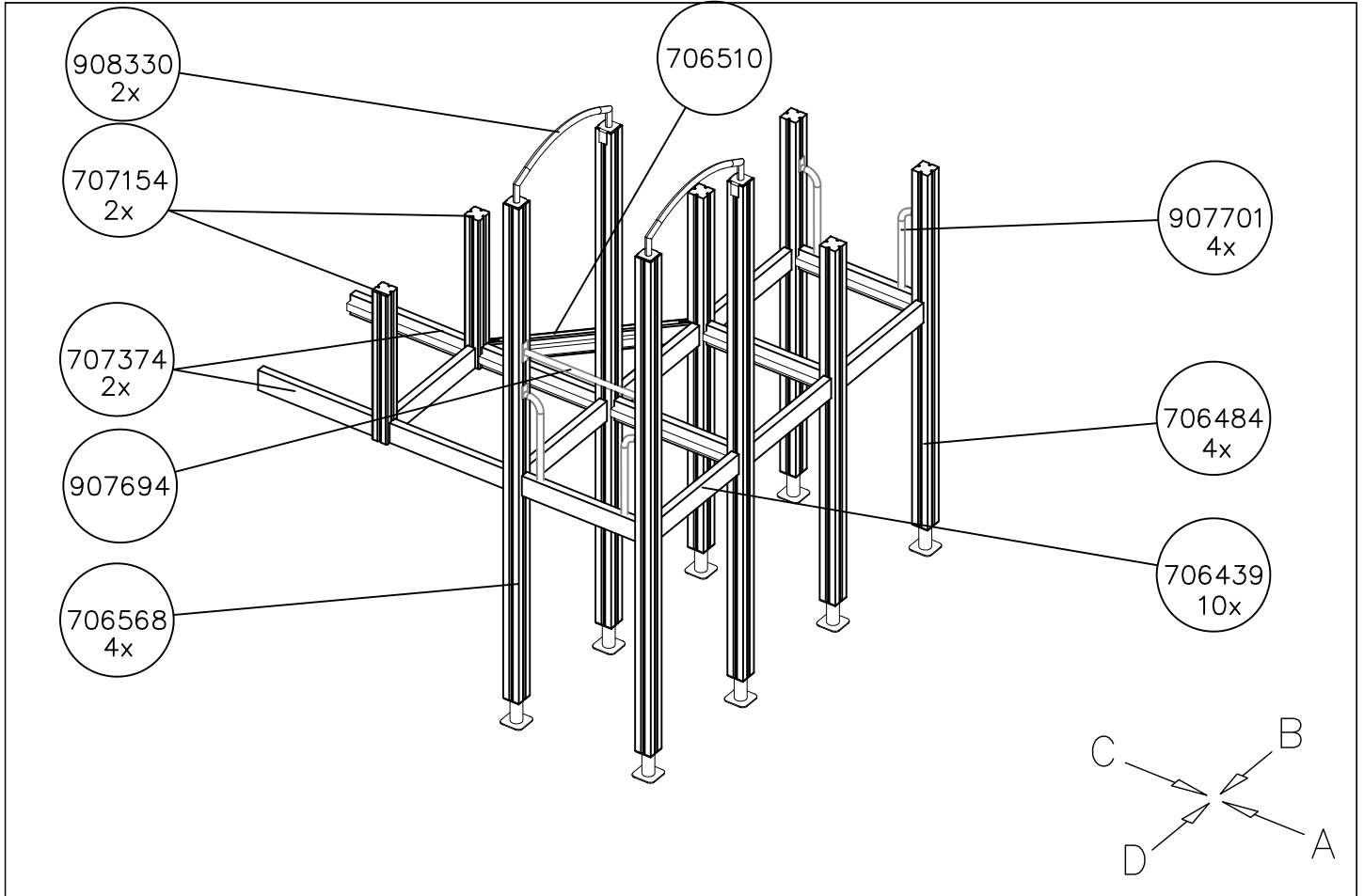

DATE: 17.1.2020

1:50

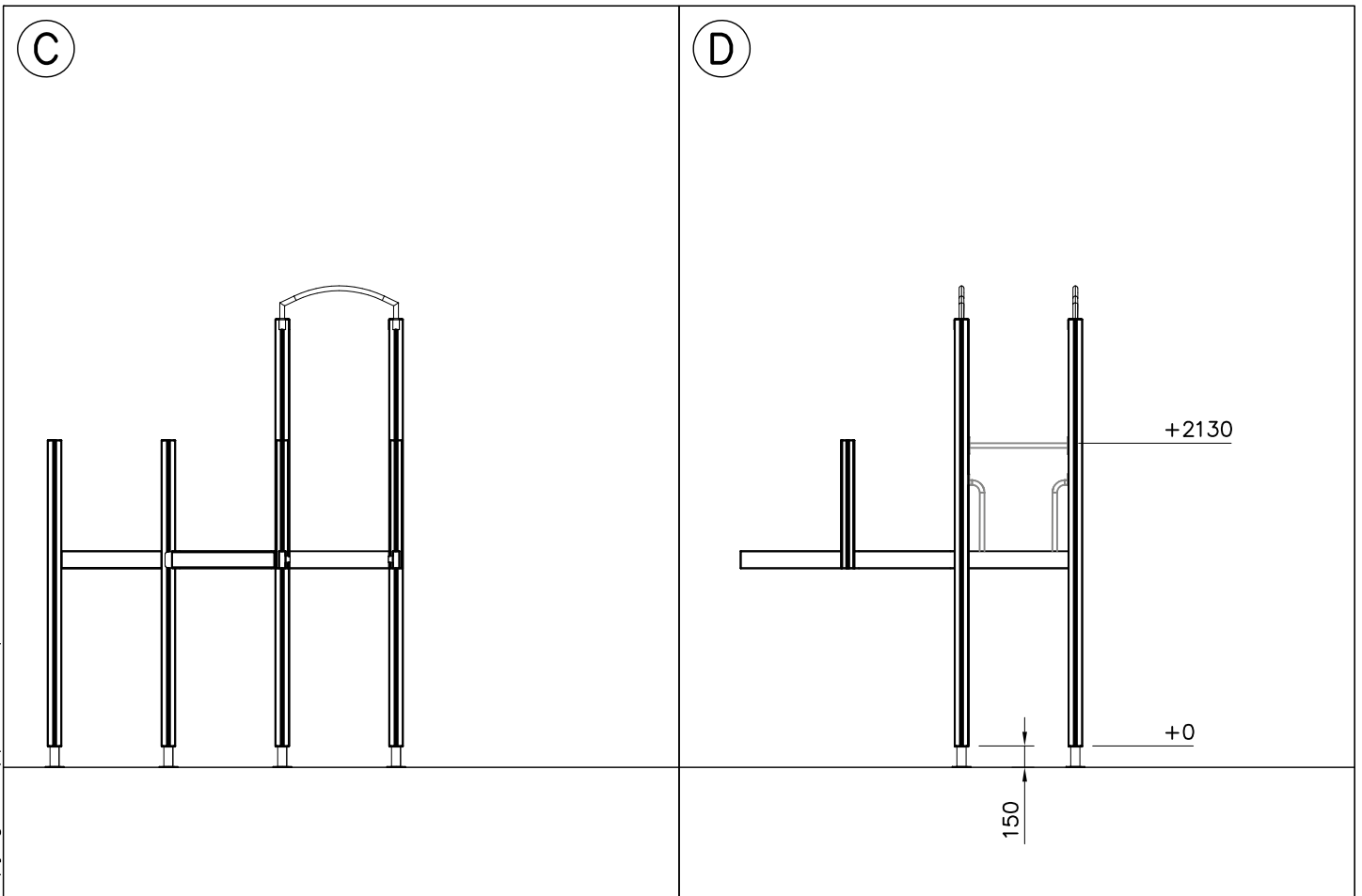
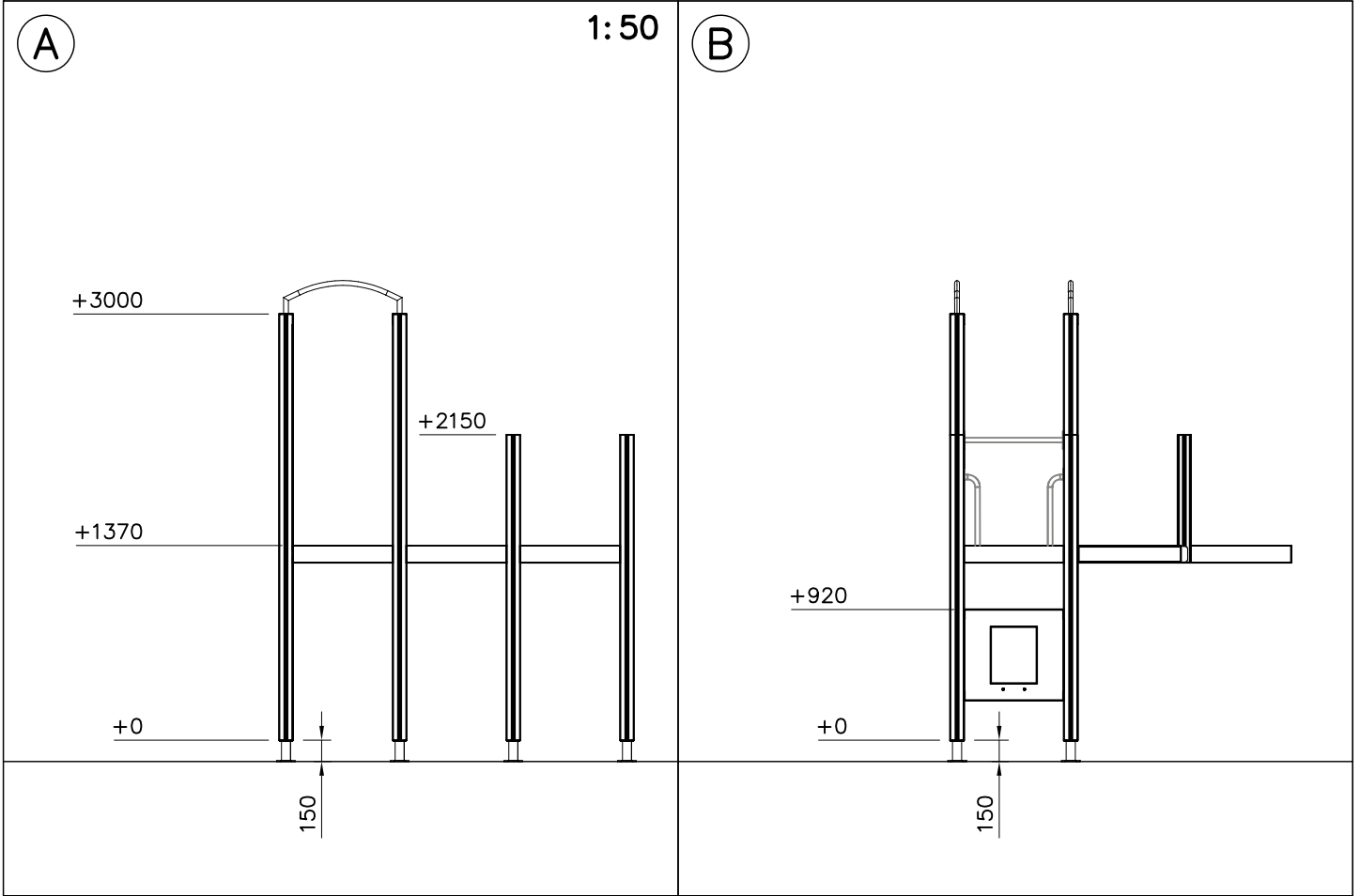

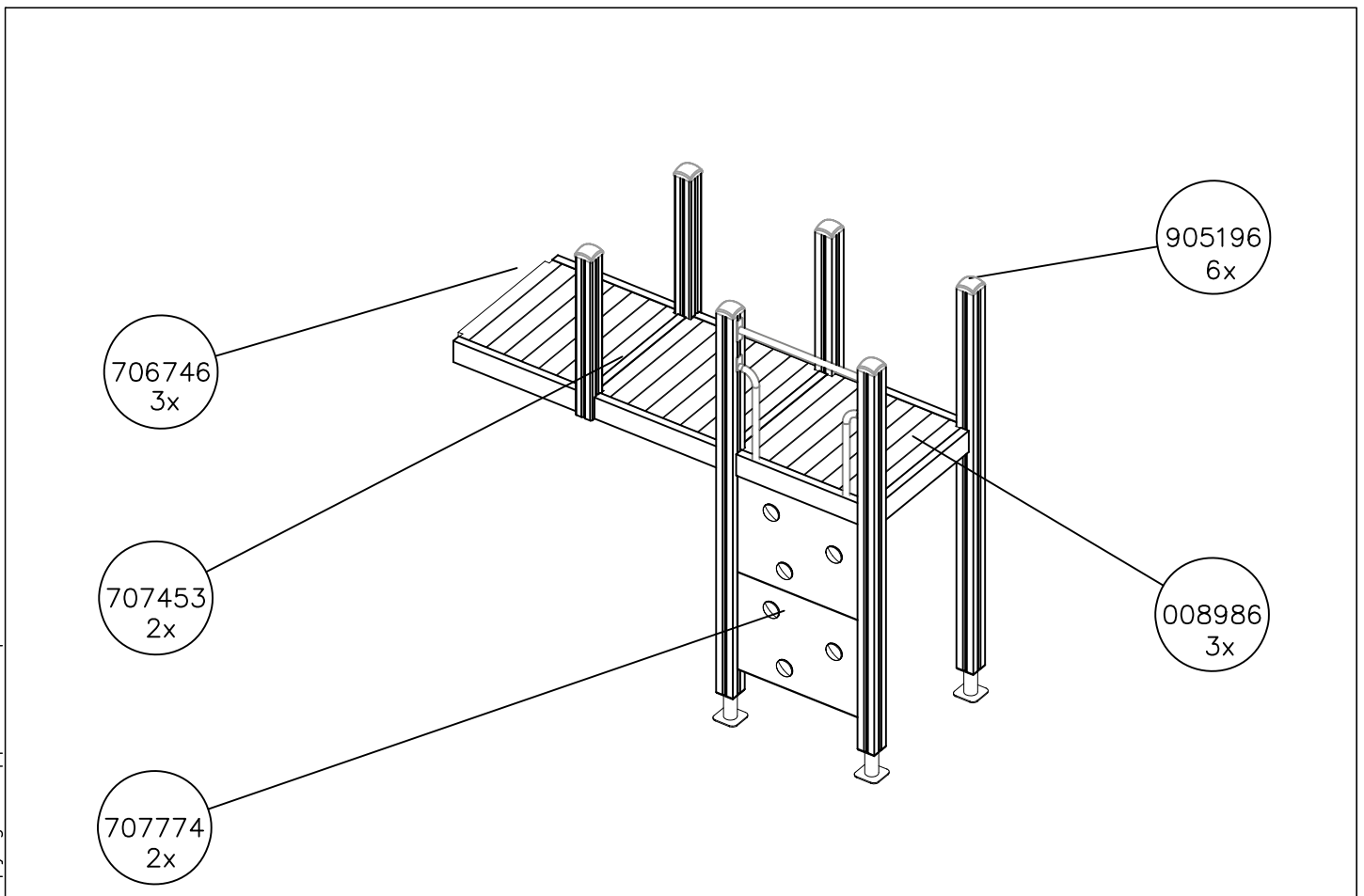
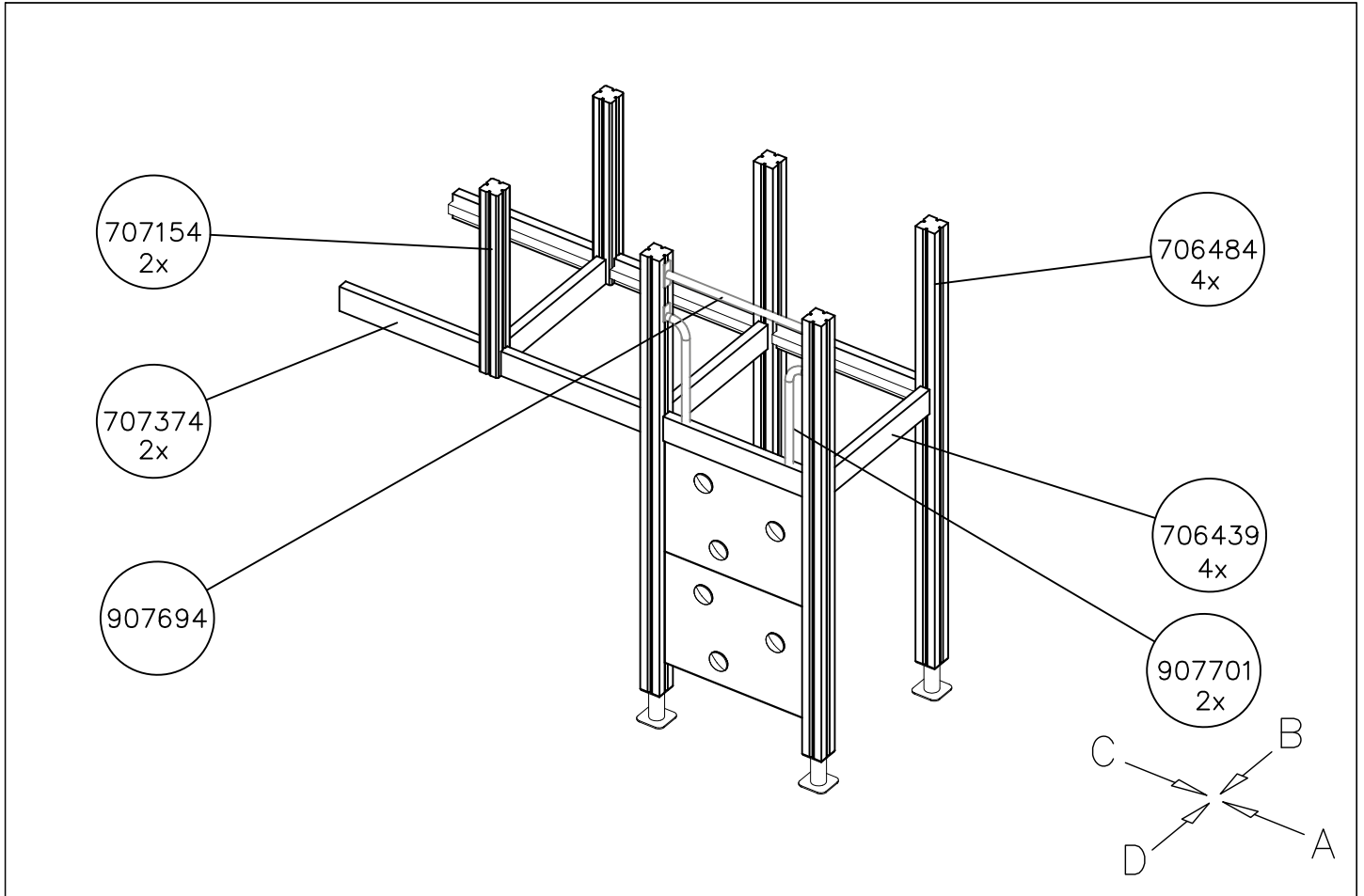

DATE: 17.1.2020

1:50

(A)

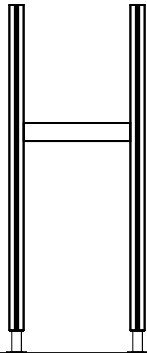

(B)

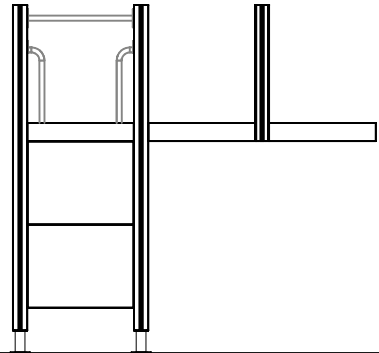

(C)

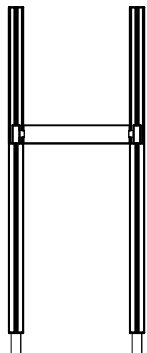

(D)

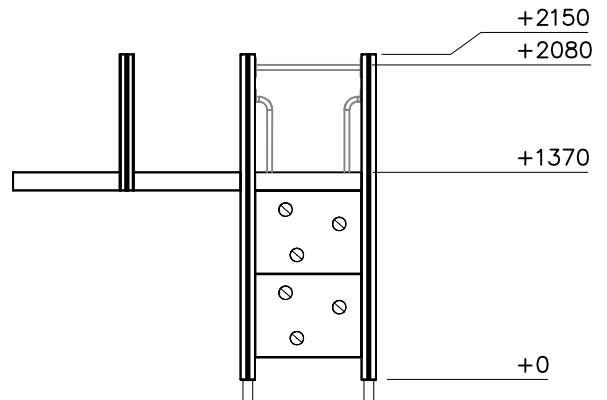

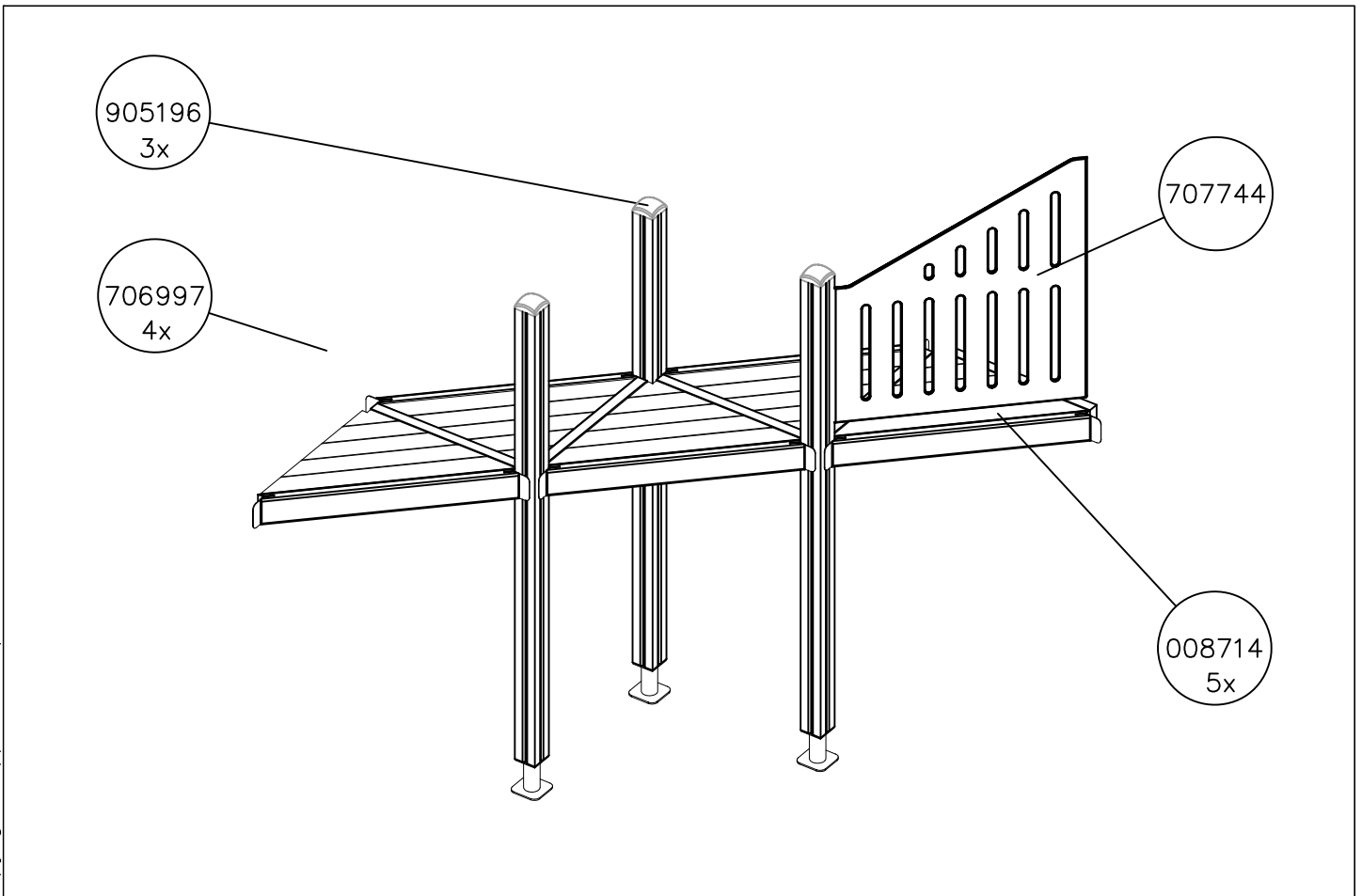
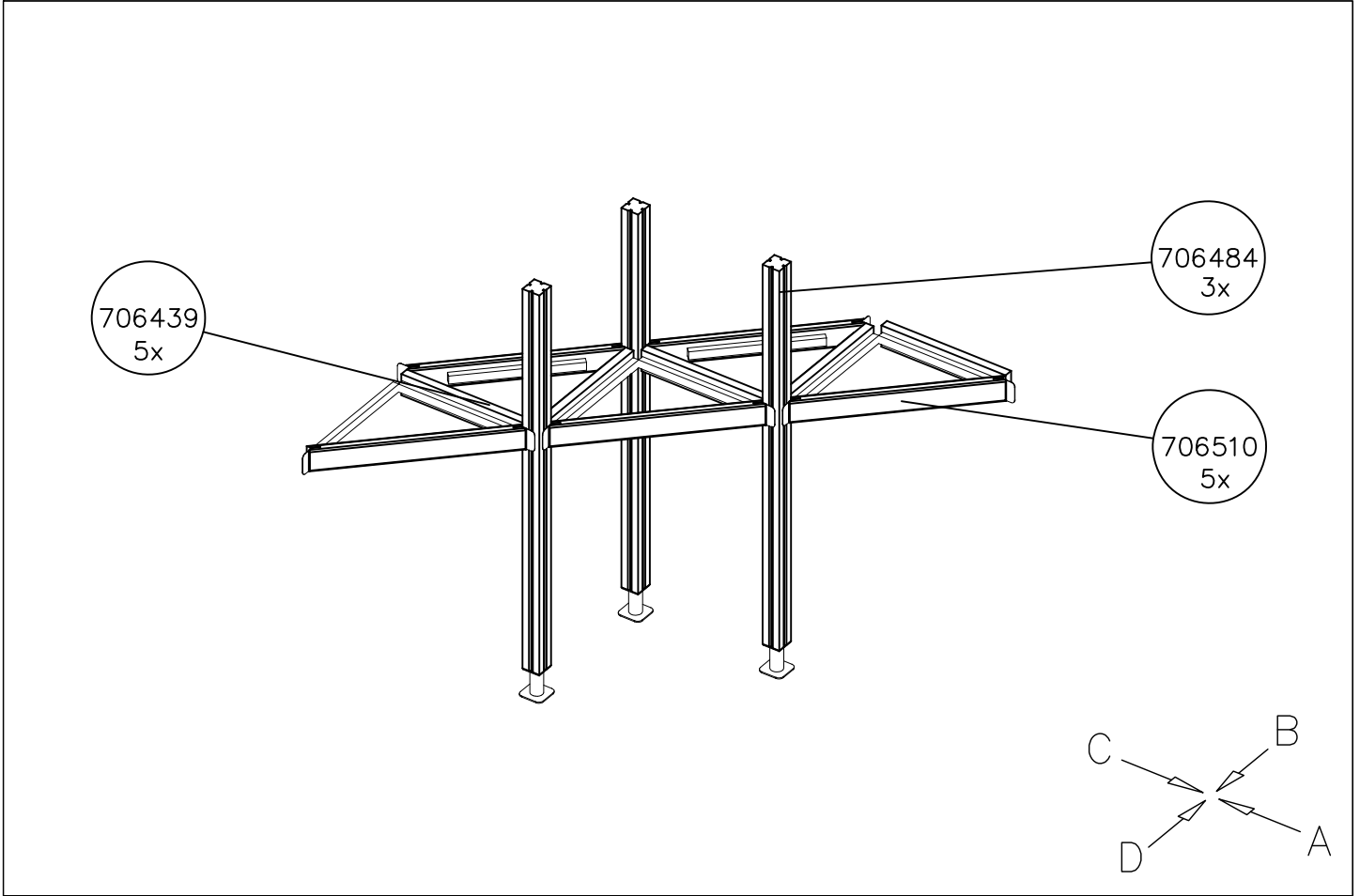

DATE: 17.1.2020

1:50

(A)

(B)

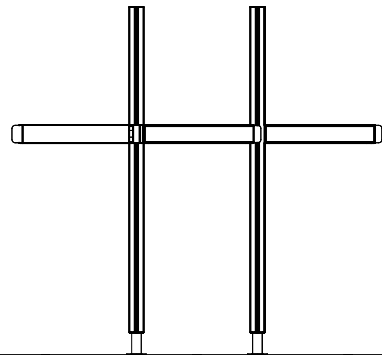
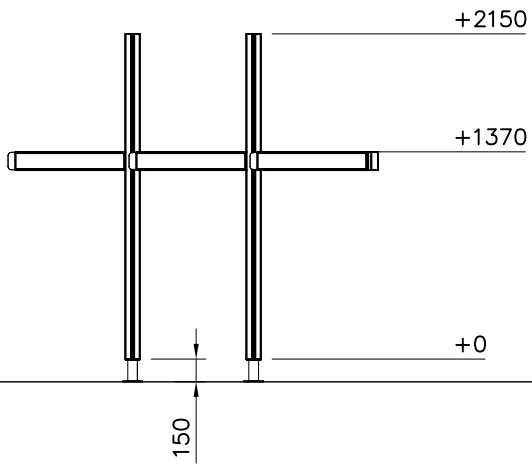

(C)

(D)

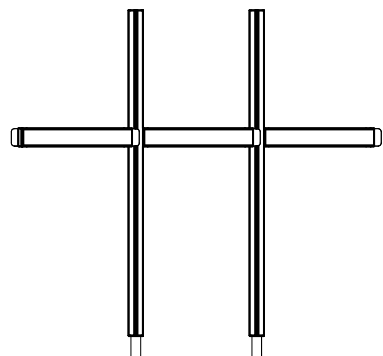
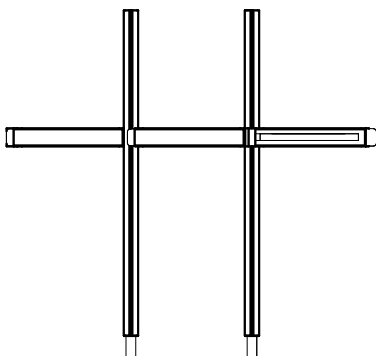

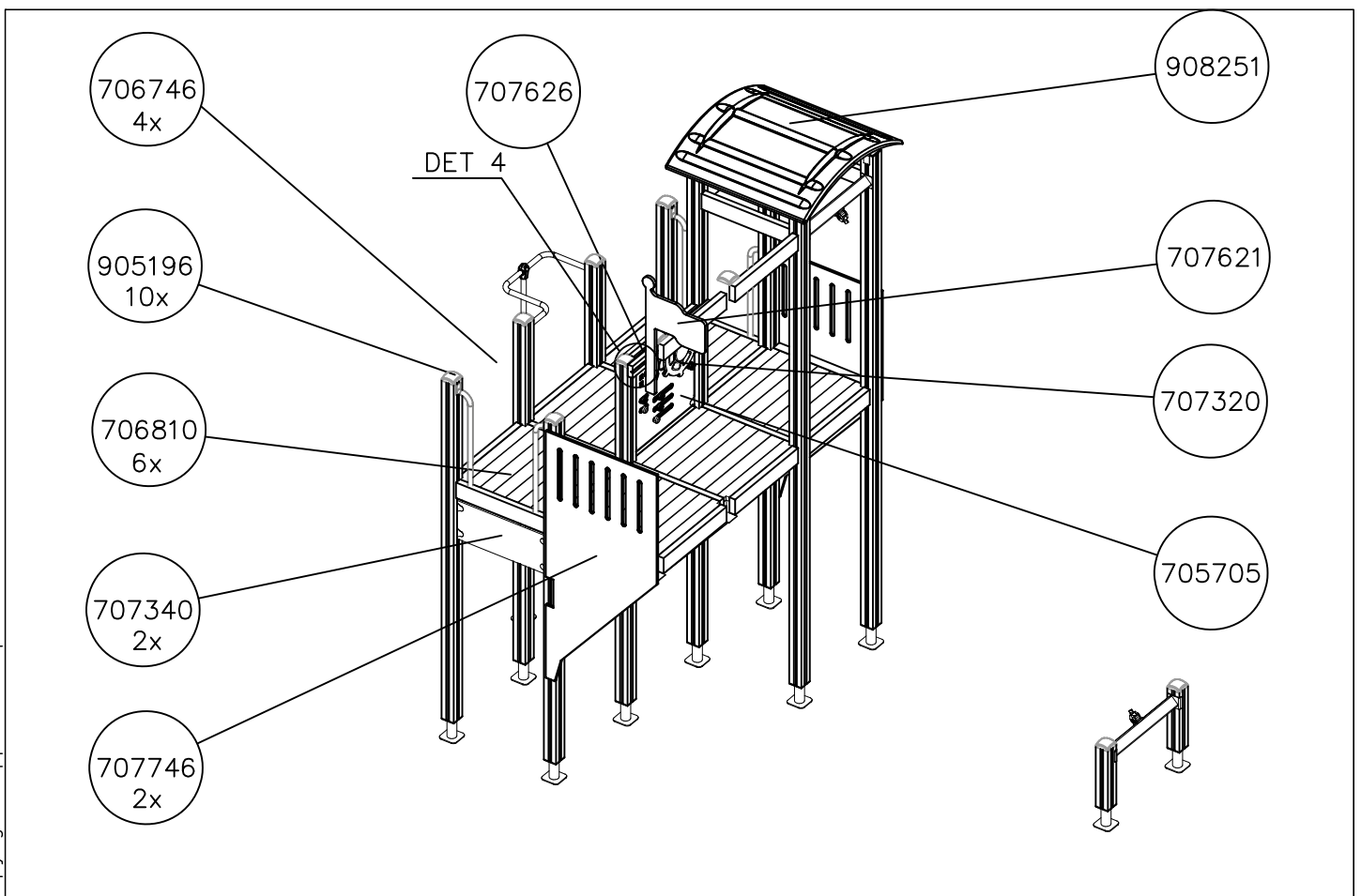
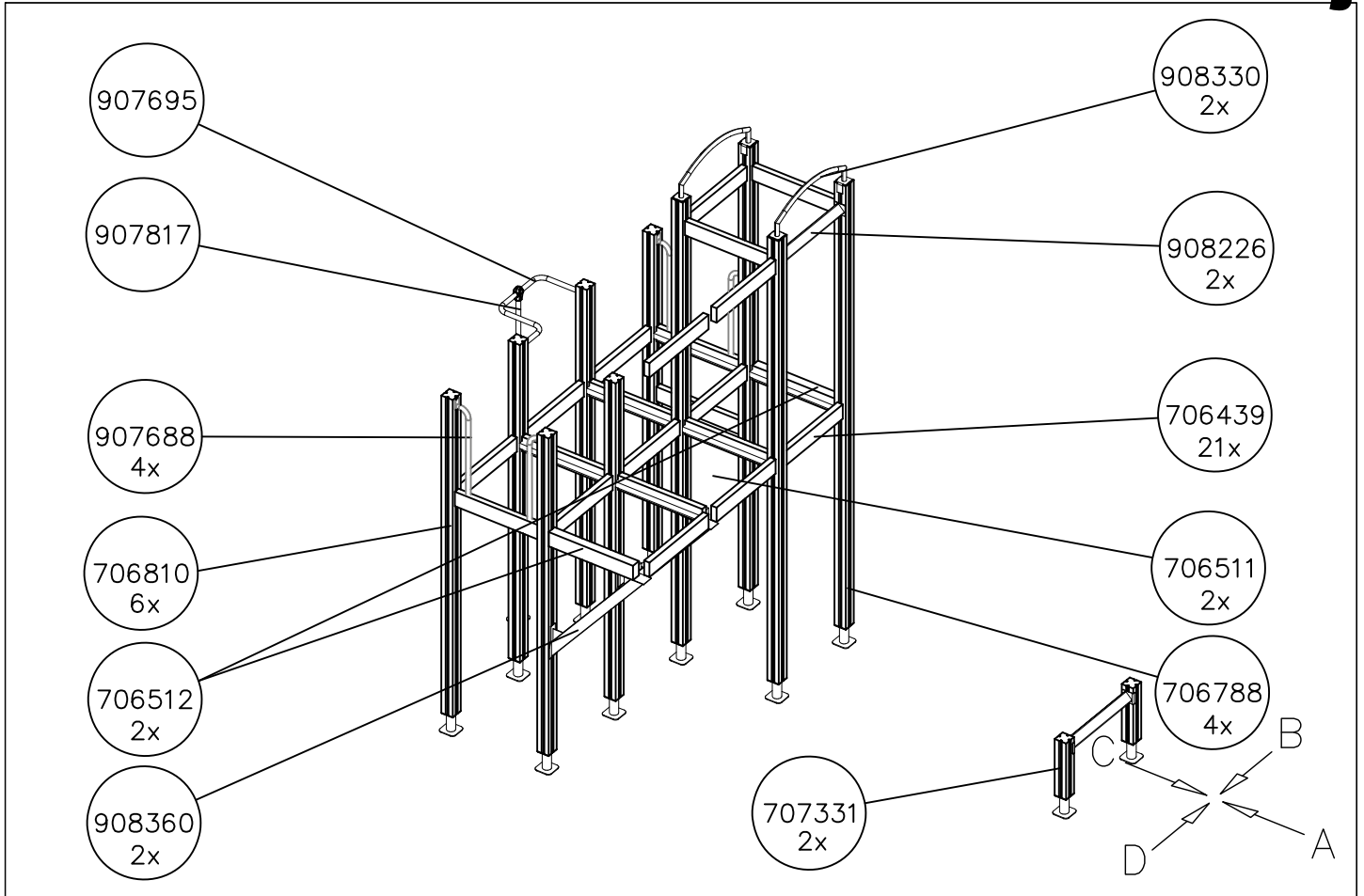

DATE: 17.1.2020

1:50

(A)

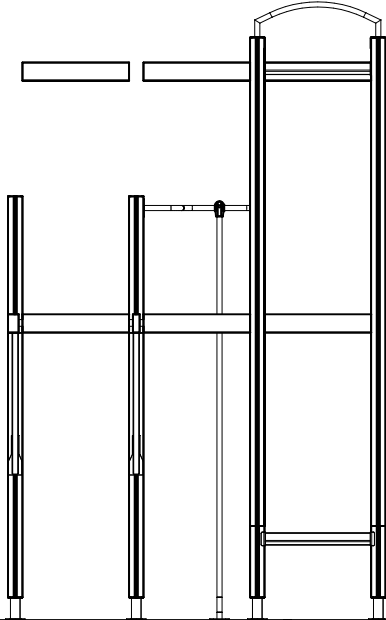

(B)

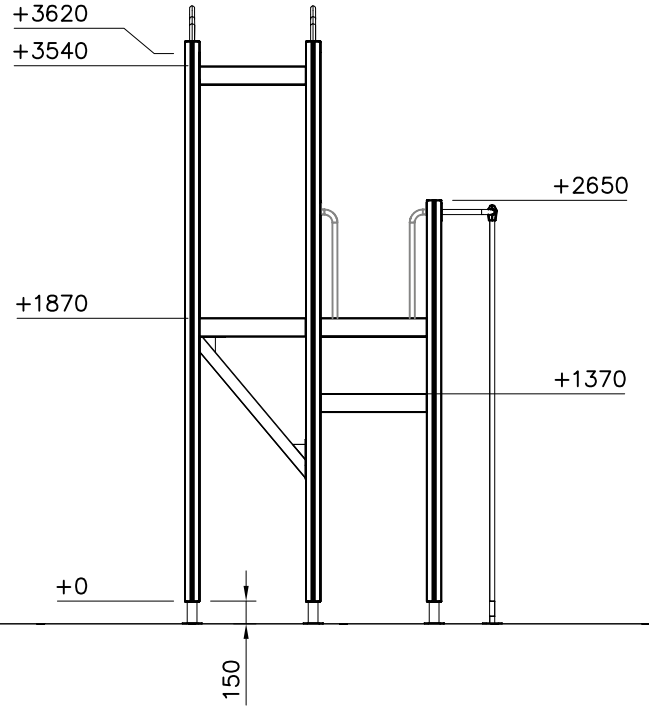

(C)

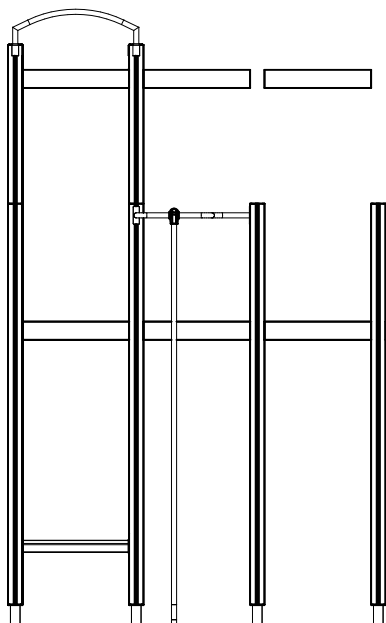

(D)

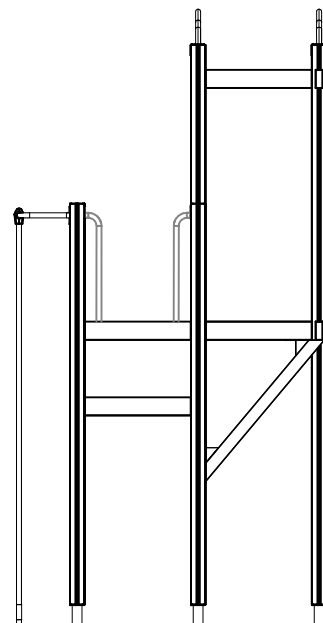

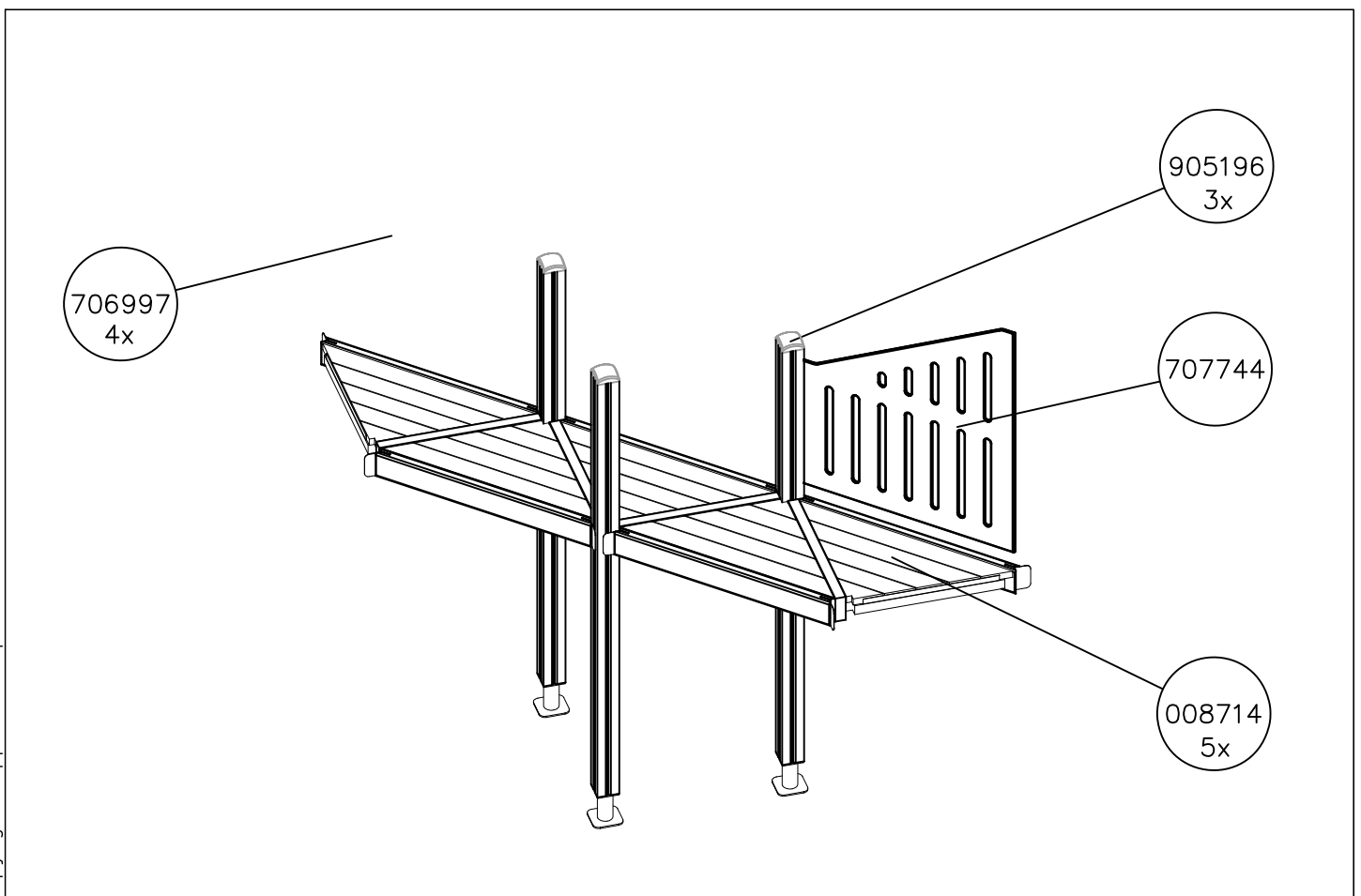
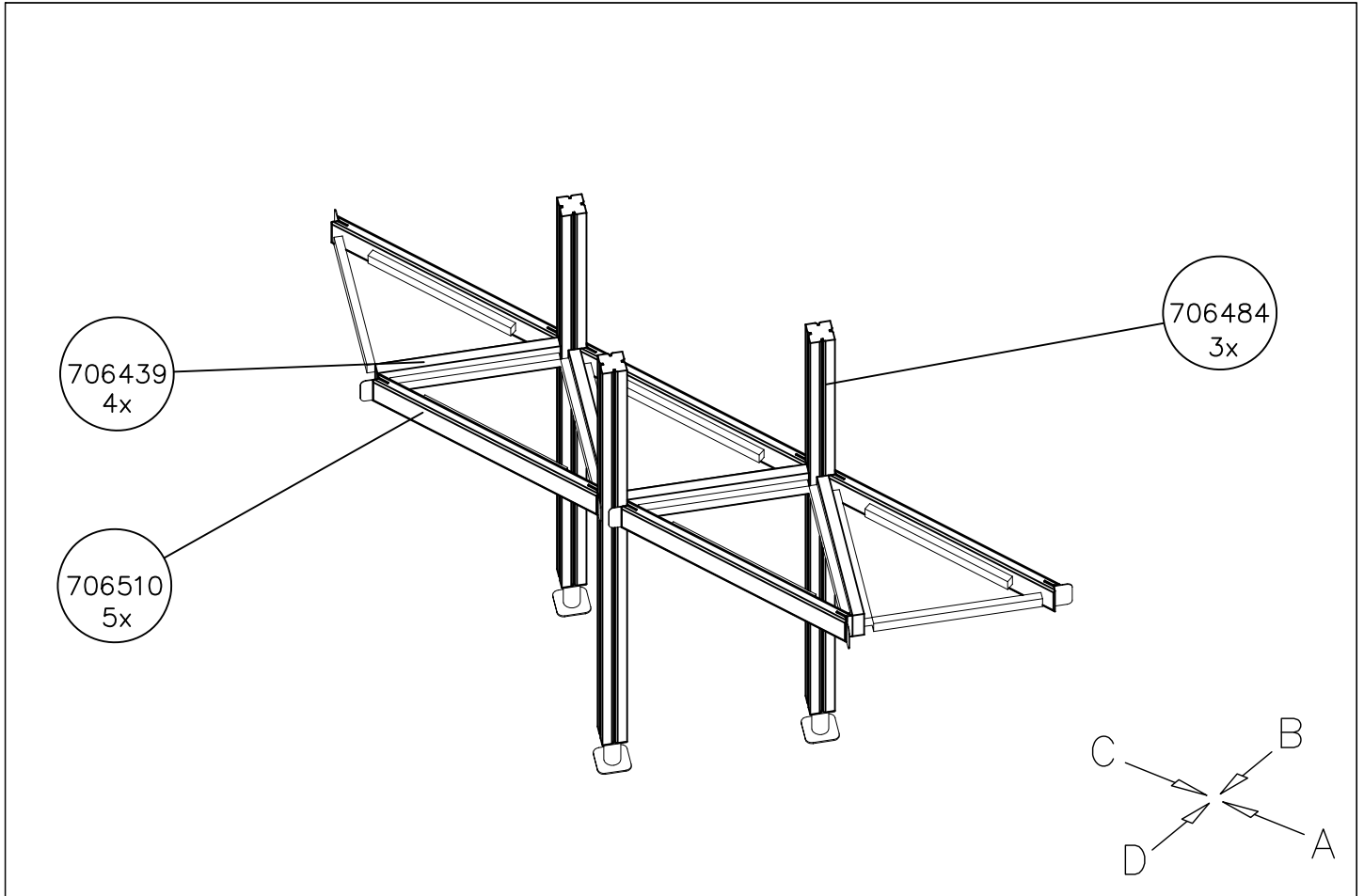

DATE: 17.1.2020

1:50

(A)

(B)

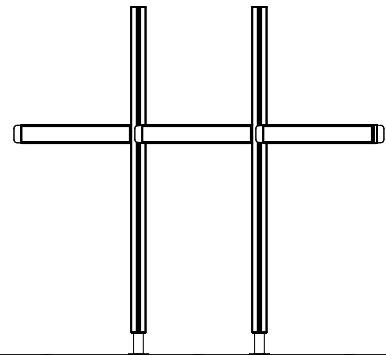
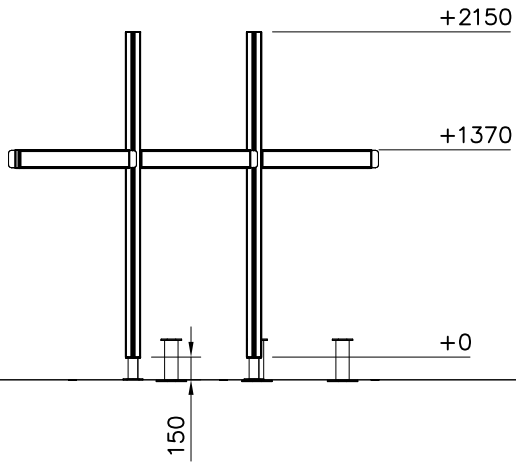

(C)

(D)

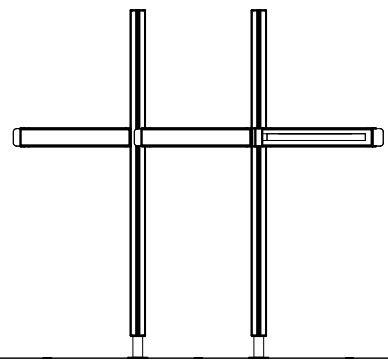
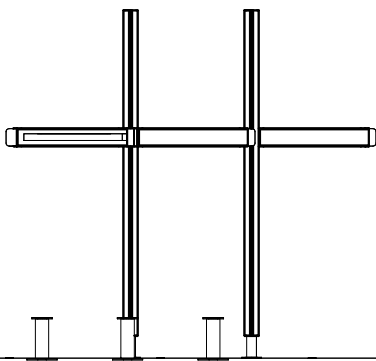

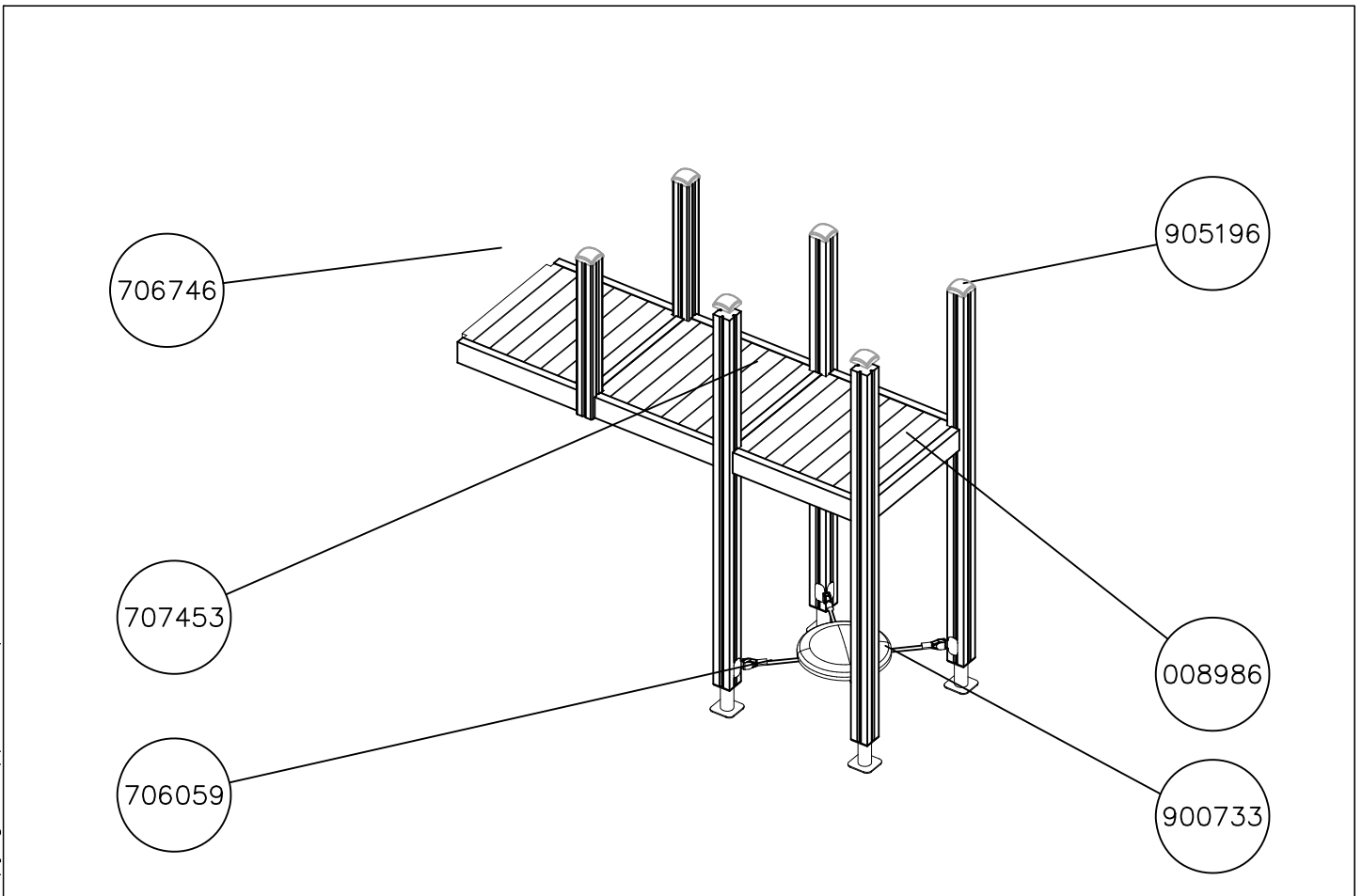
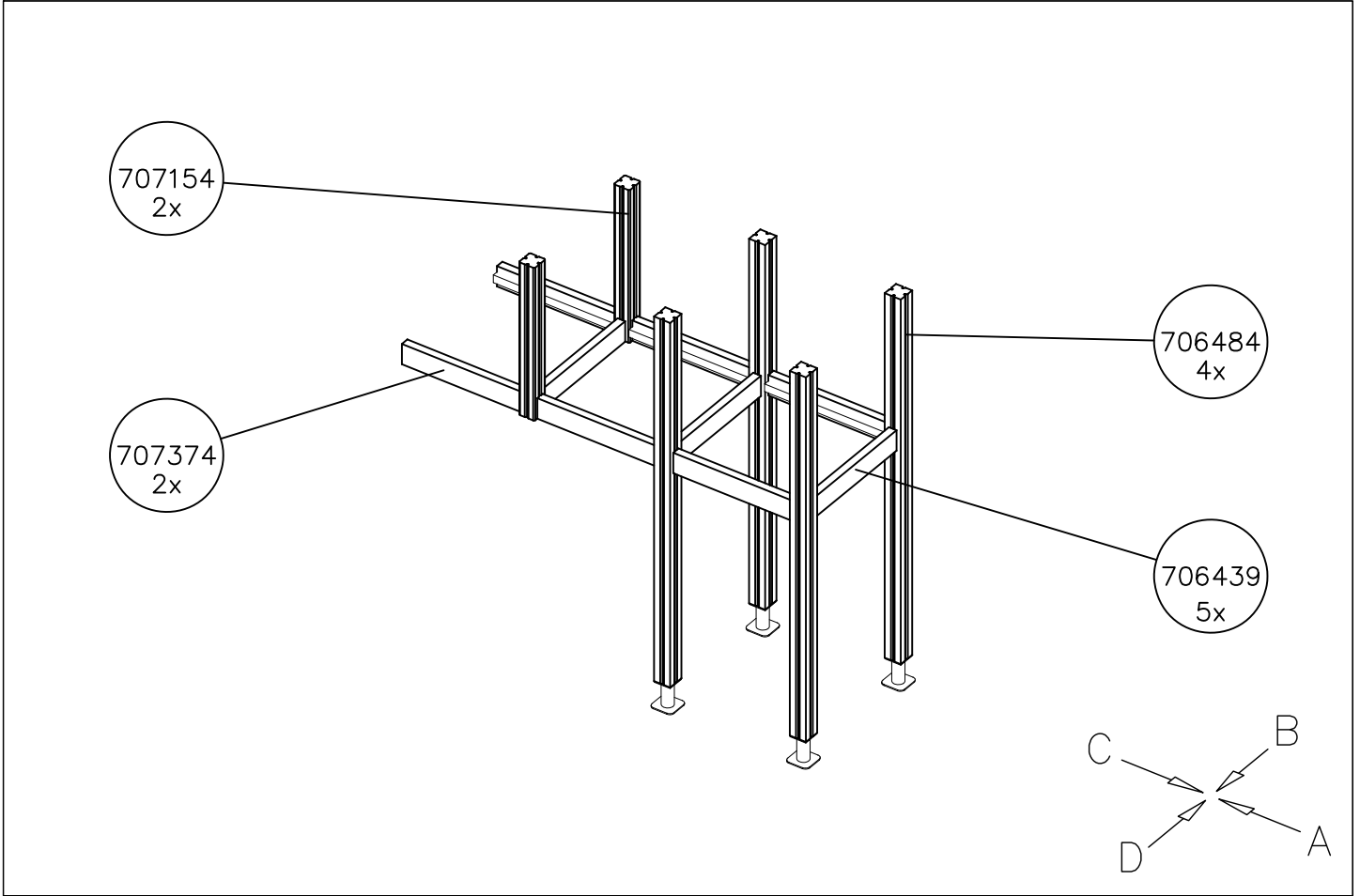

DATE: 17.1.2020

1:50

(A)

(B)

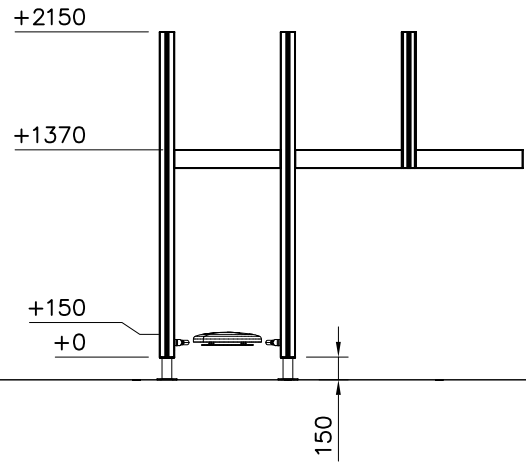
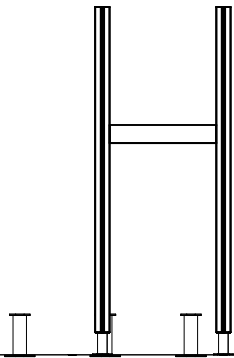

(C)

(D)

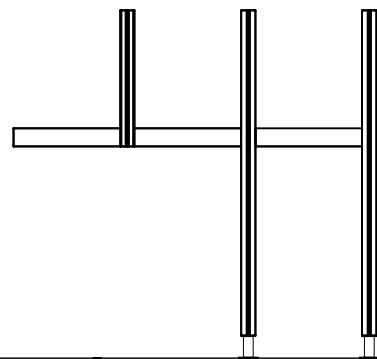
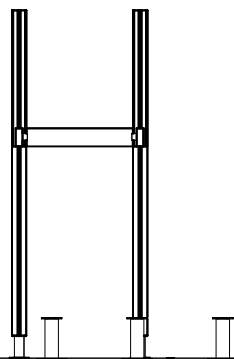

DATE: 17.1.2020

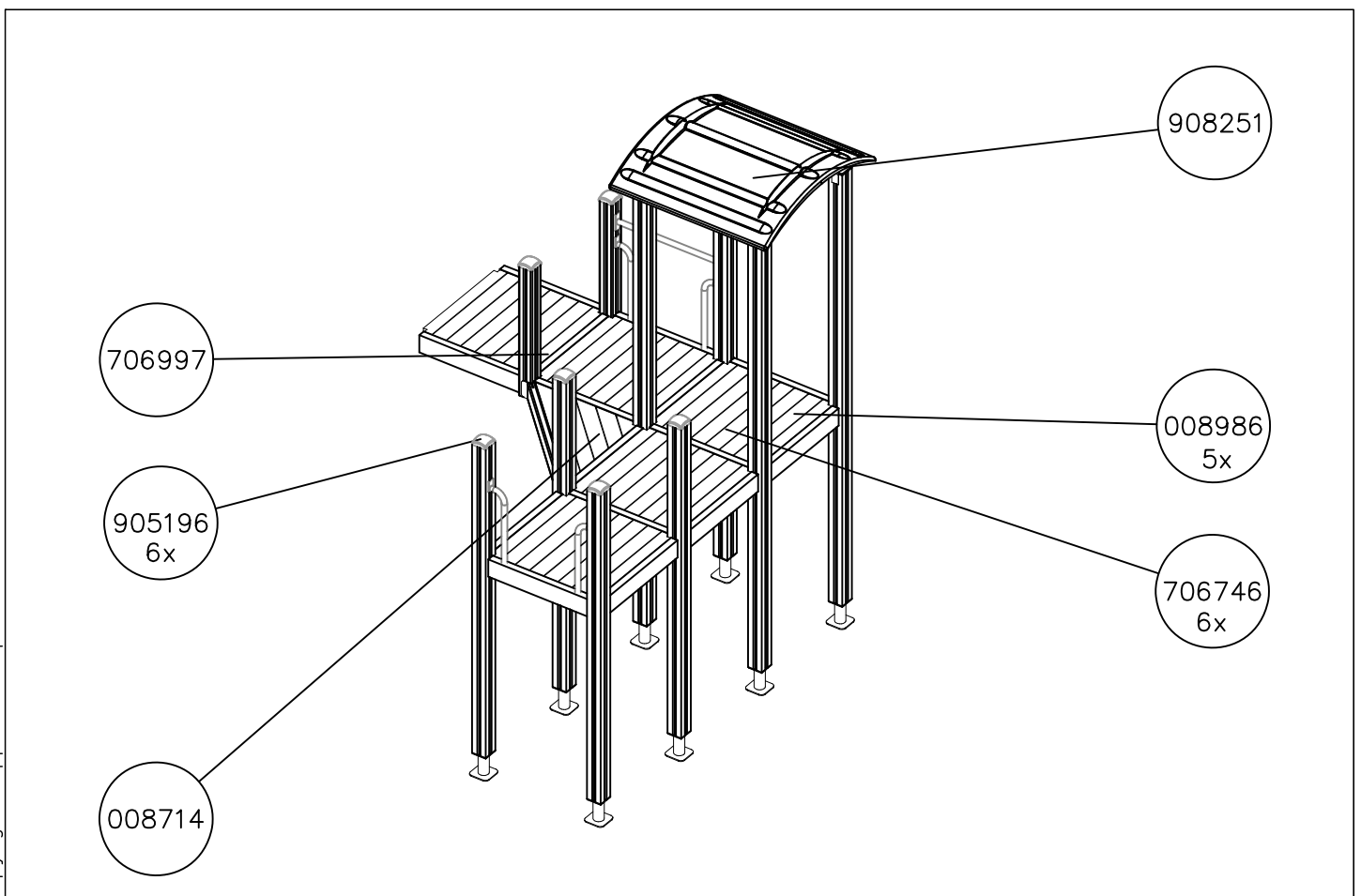
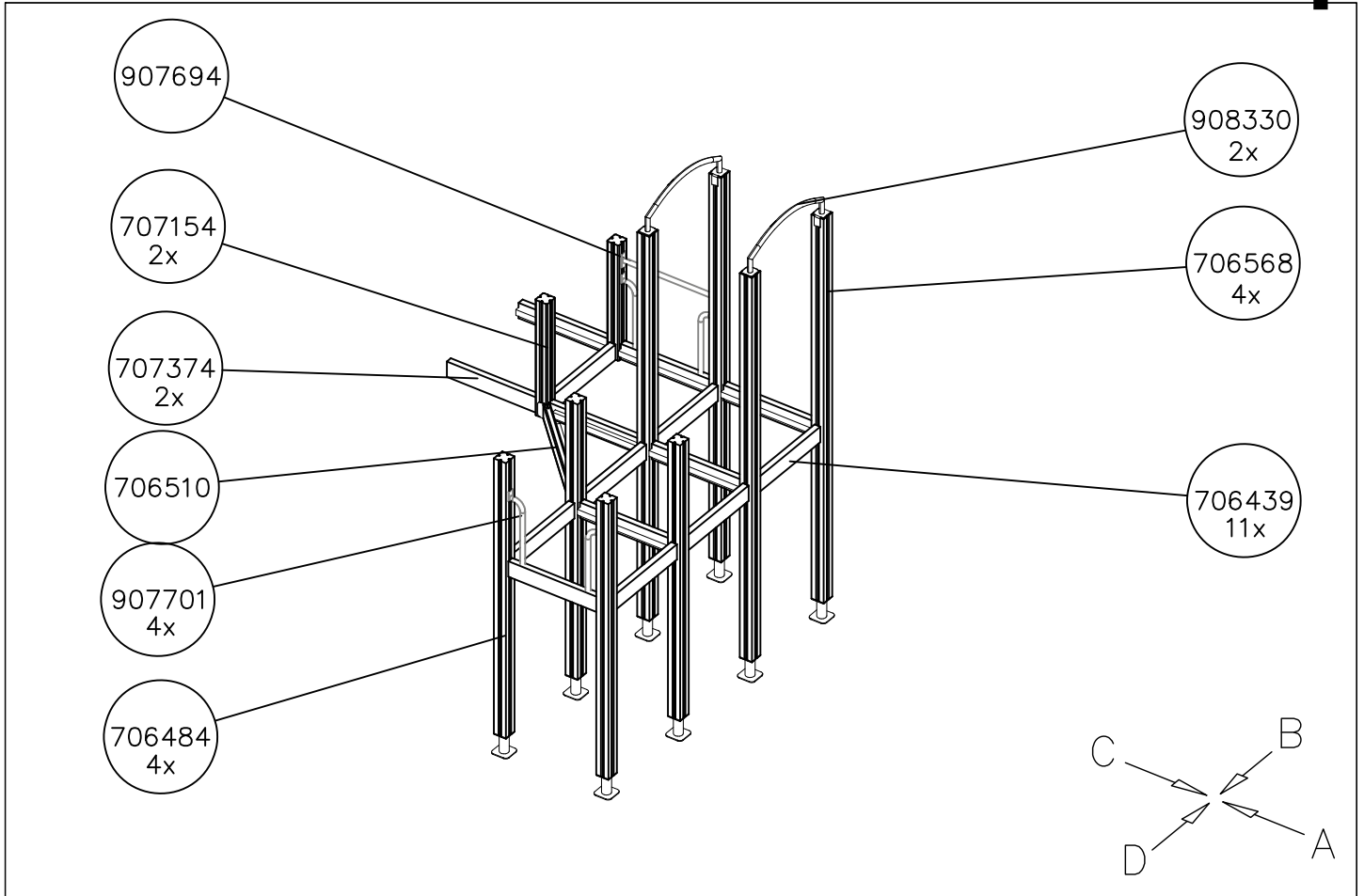

DATE: 17.1.2020

1:50

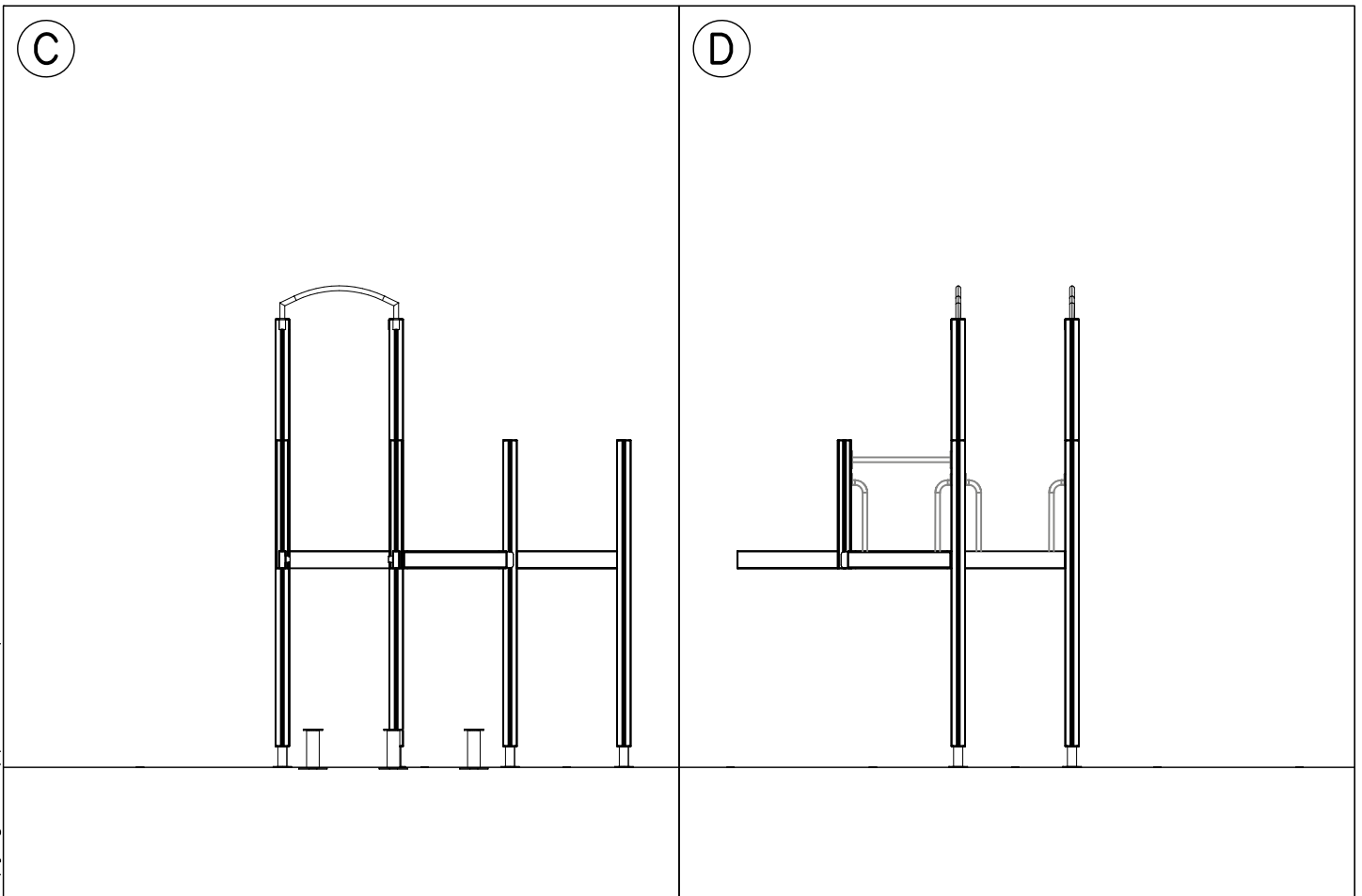
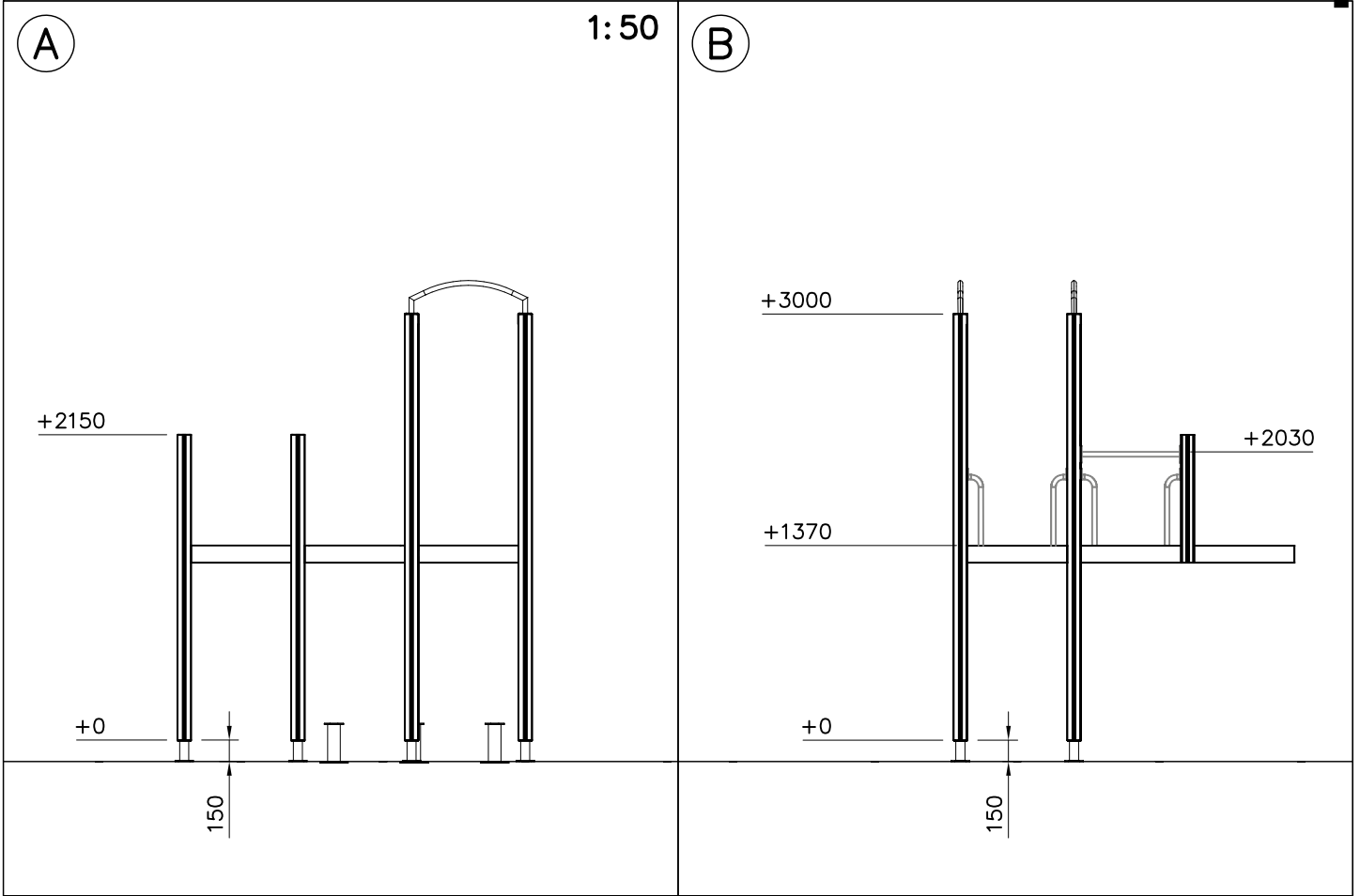

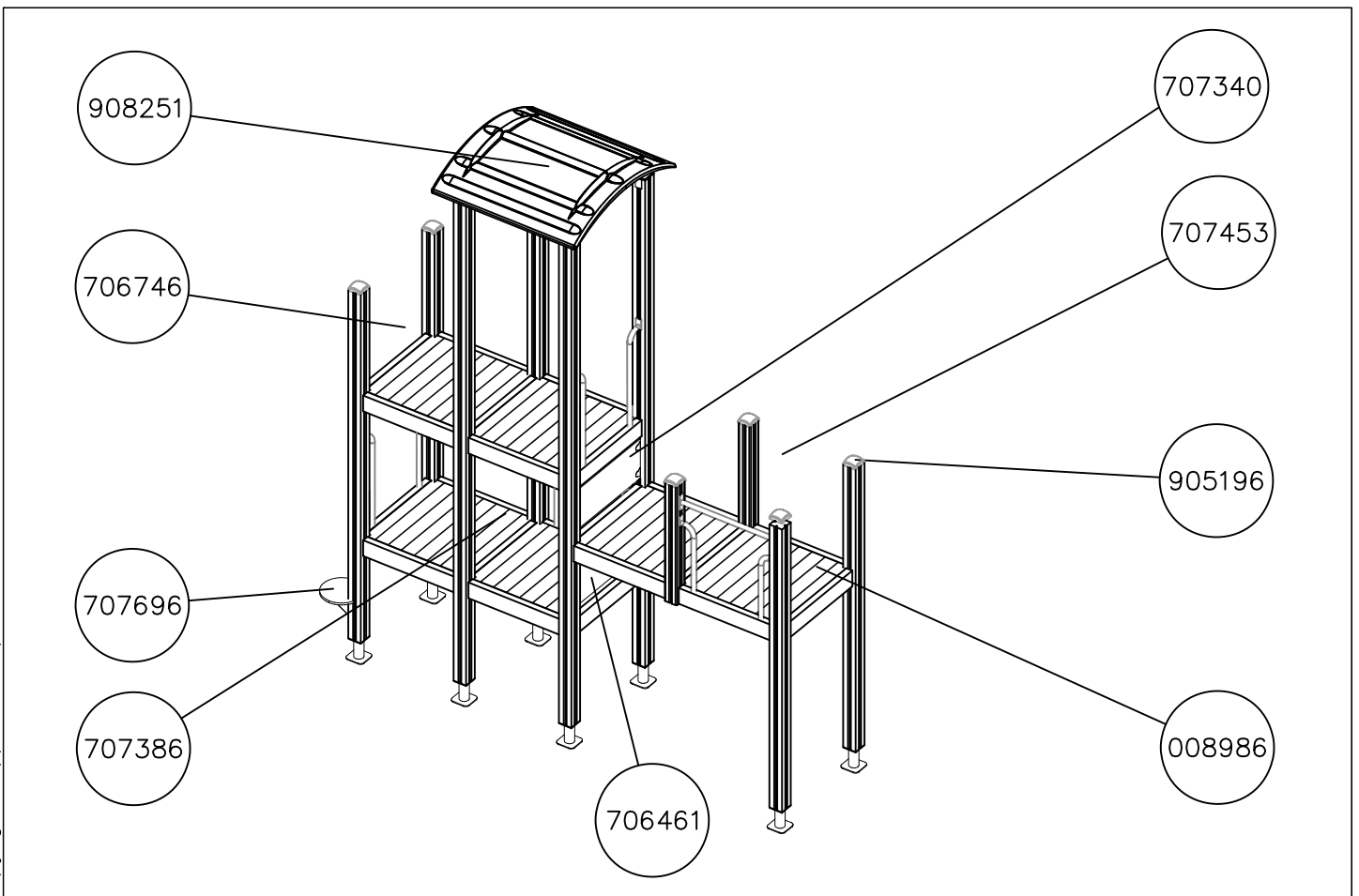
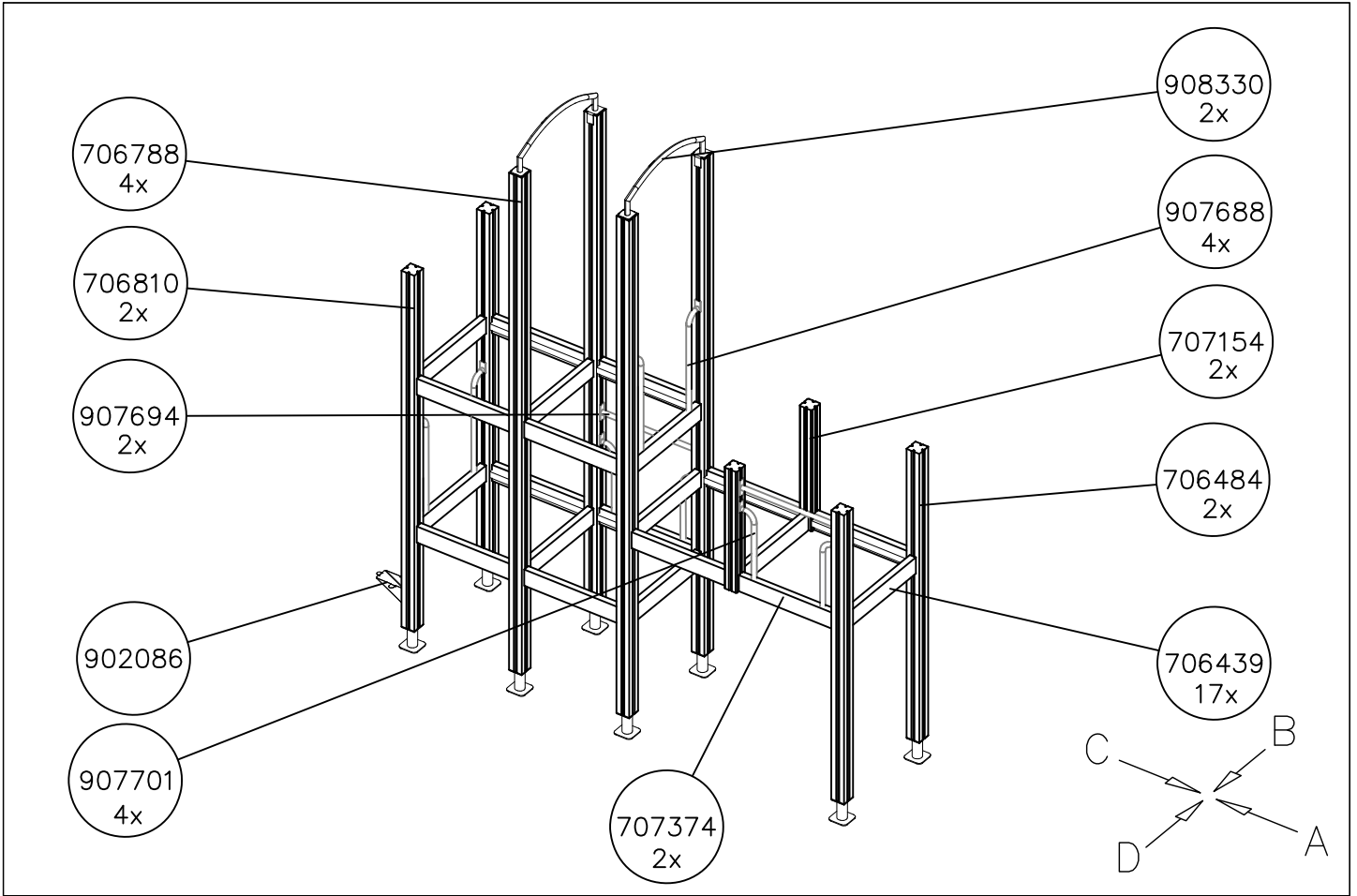

DATE: 17.1.2020

1:50

A

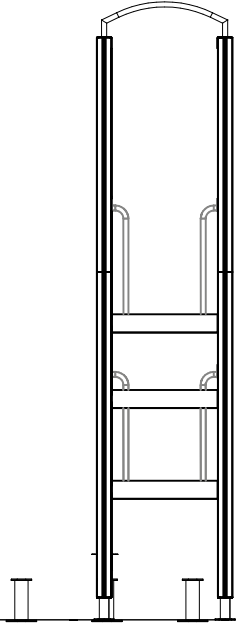

B

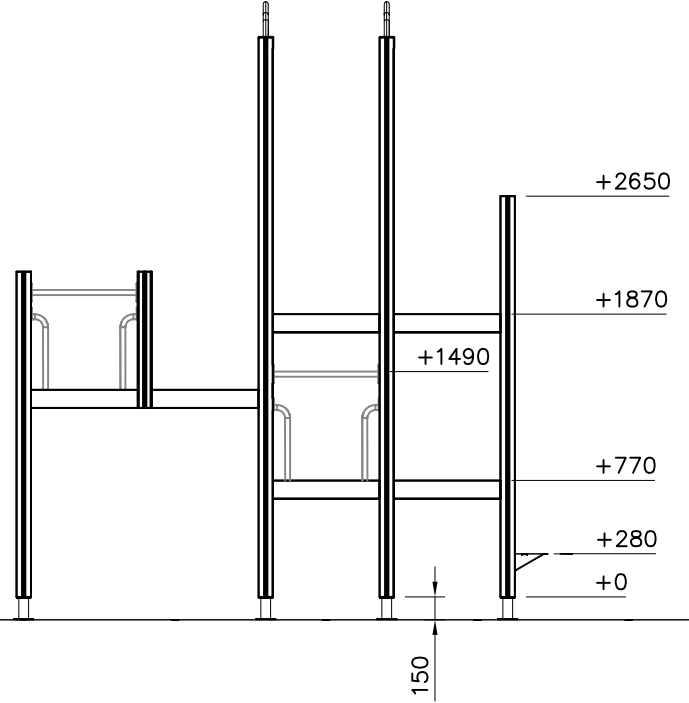

C

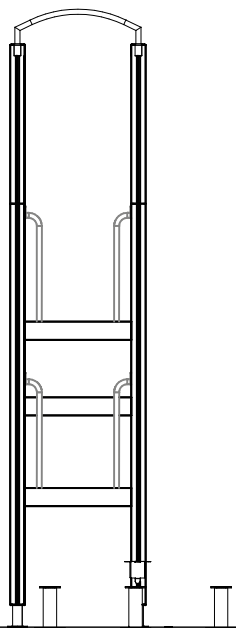

D

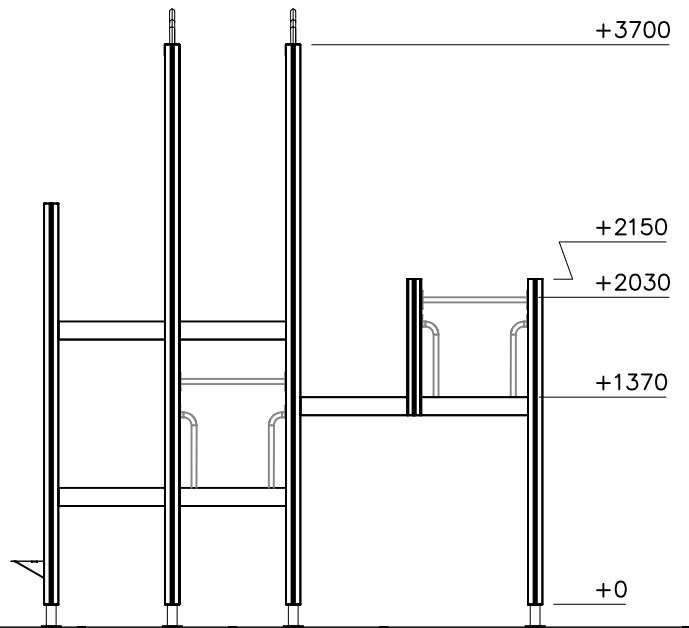

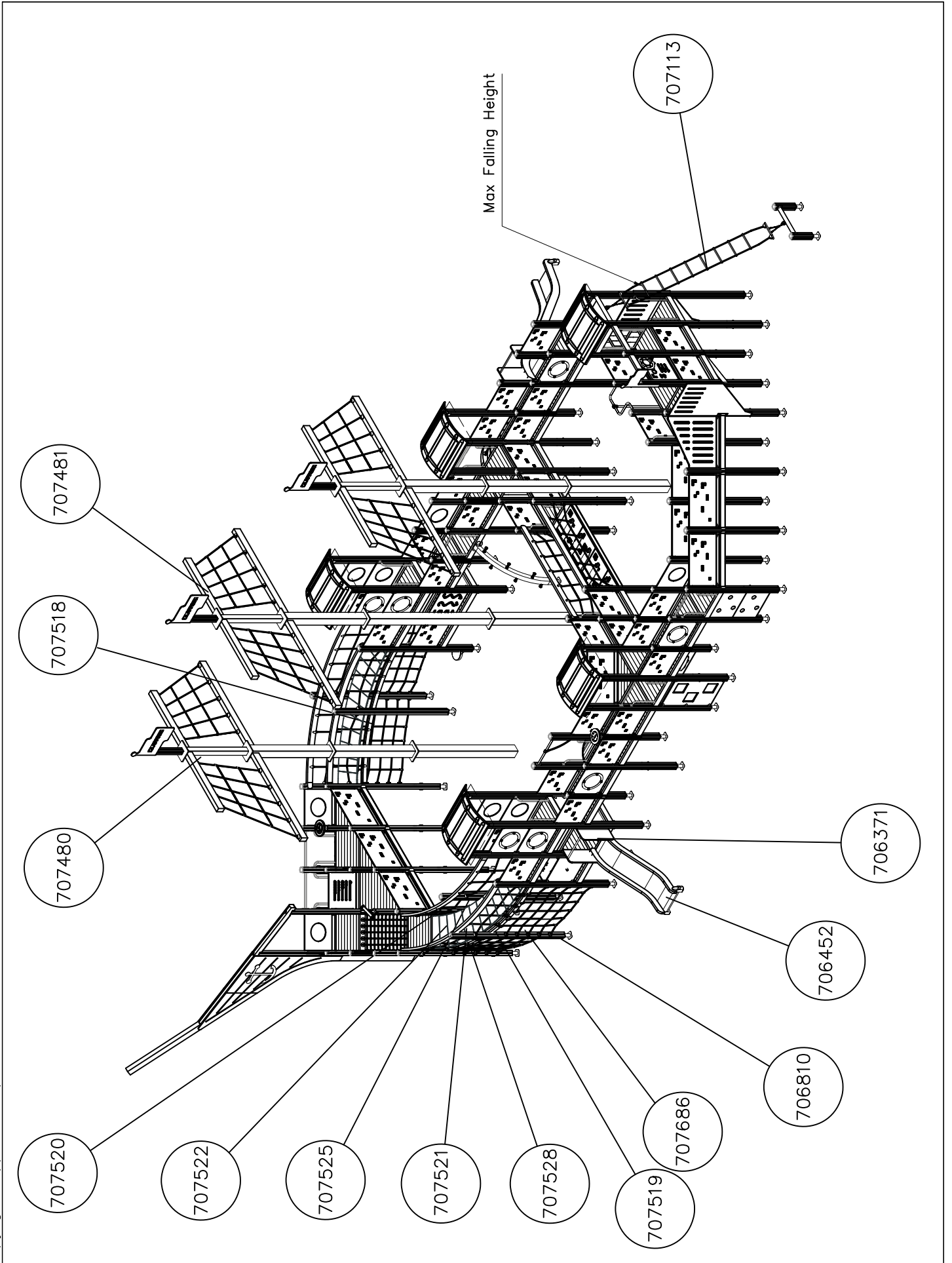

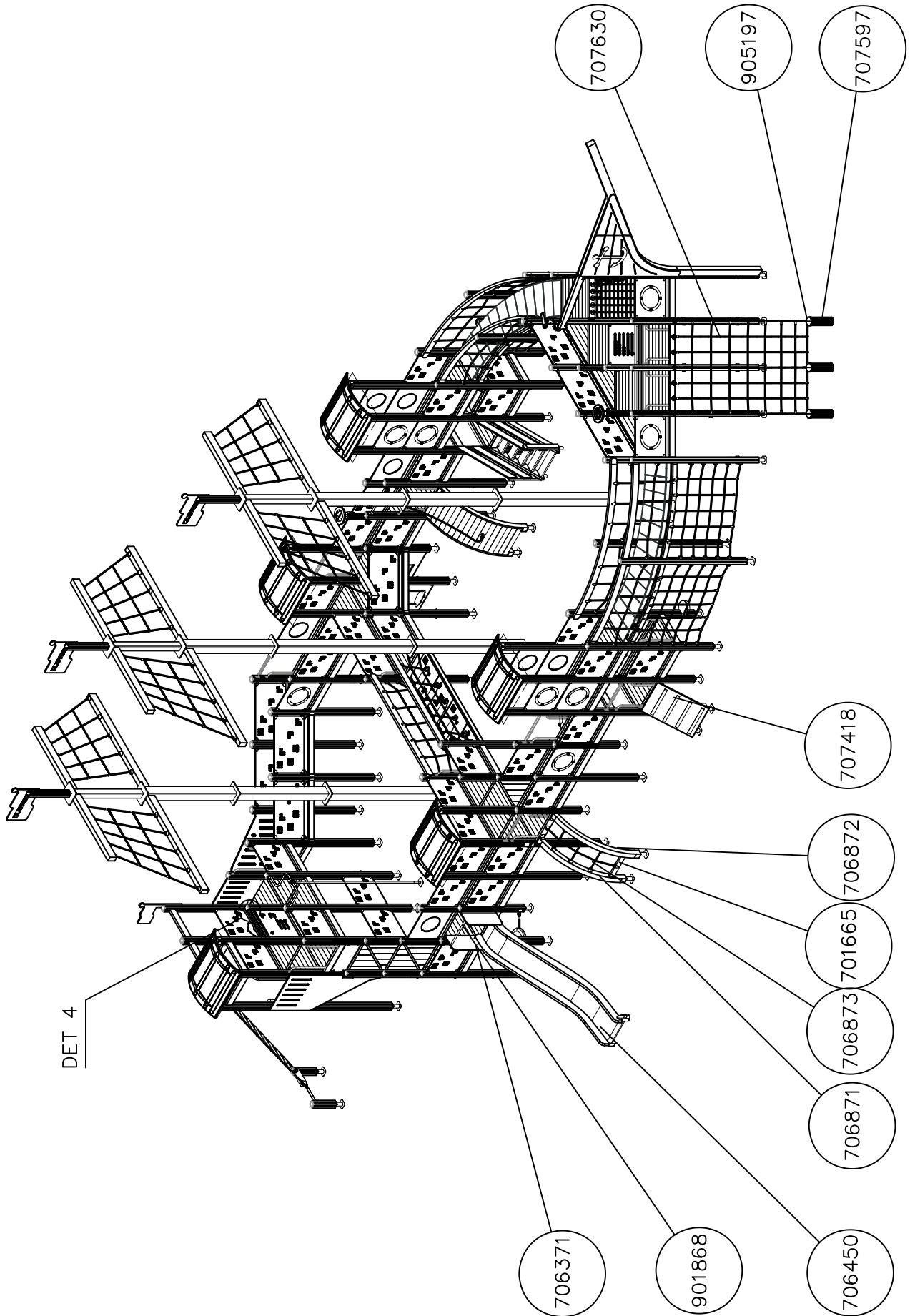

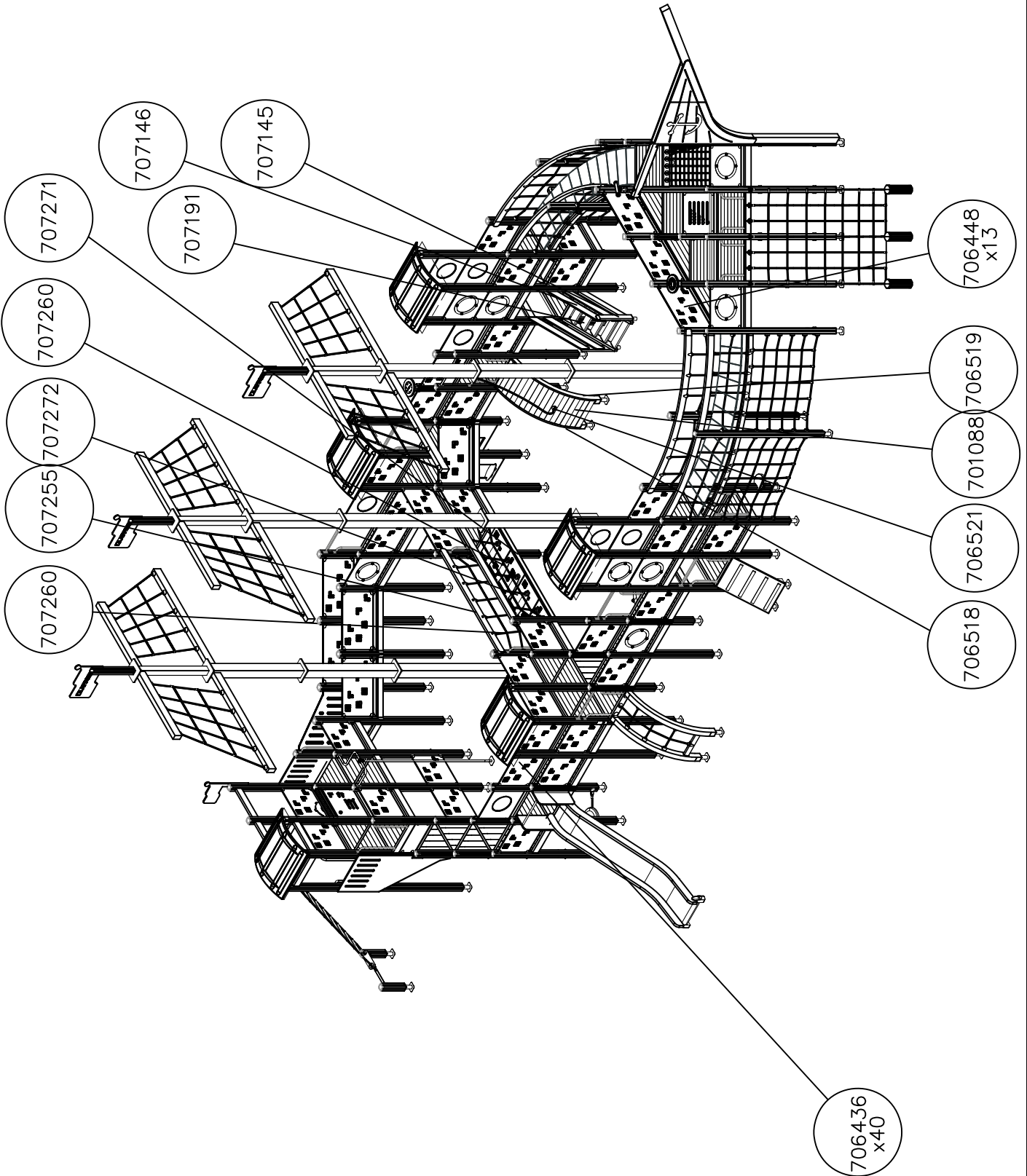

1. Tarkista tuoteosaluettelon ja osiin merkittyjen tuotenumeroiden avulla, että kaikki osat sisältyvät toimitukseen.
2. Valitse välineelle paikka ottaen huomioon valmistajan asennusohjeessa ilmoittamat turvaetäisyydet. Valitessasi välineen asennussuuntaa, huomioi mahdollinen altistuminen voimakkaalle auringonpaisteelle tai tuulelle. Tasoita alue ja tee ohjeen mukaiset perustustyöt. Varmista, että perustusosien alapuolinen maa on **tiivistetty riittävästi**. Tarvittaessa pohjamaa tulee vaihtaa murskeeseen tai vastaavaan kantavaan maainekseen. Iskua vaimentavan pintamateriaalin vahvuus määräytyy laskentakaavan perusteella, joka esitetään perustusohjeen lisäsivulla.
3. Välineen rungon pystystysohje esitetään sivulla 6. Yksityiskohtaiset kuvat asennuksesta on koottu erillisille ohjesivuille, joissa ne on ryhmitelty kiinnitystavan mukaan. Runkoon kiinnitettävistä komponenteista on erilliset moduuliohjeet. Noudata valmistajan asennusohjeessa ilmoittamia mitoituksia.
4. Tarkasta, että väline on suorassa ja perustukseltaan tukeva. Syväperusteisissa välineissä on suoritettava **riittävä maan tiivistäminen** kaivantojen täytön yhteydessä.
5. Tee käyttöönottotarkastus ennen välineen käyttöönottoa toimitukseen sisältyvän pöytäkirjan mukaisesti. Pöytäkirja tulee dokumentoida. Muista, että pääsy välineeseen tulee estää, kunnes se on valmis, turvallinen ja kaikki asennustarvikkeet on viety pois.

1. Kontrollera stycklistan och delarna i förpackningen med hjälp av produktnumren.
2. När du väljer platsen för utrustningen bör du beakta de säkerhetsavstånd som tillverkaren meddelat i monteringsanvisningarna. När du väljer monteringsriktning måste du beakta eventuell exponering för solsken eller vind. Jämna ut underlaget och utför grundarbetet i enlighet med instruktionerna. Säkra att marken under fundamentet är tillräckligt komprimerad. Vid behov kan man ersätta jorden med krossad sten eller motsvarande bärande jordmaterial. Styrkan på det slagdämpande ytmaterialet bestäms med hjälp av beräkningsformeln som presenteras på fundamentinstruktionernas tilläggsida.
3. Monteringsanvisningarna till utrustningens stomme finns på sidan 6. Detaljerade bilder av installationen har samlats på separata instruktionssidor, där de har grupperats enligt monteringsmetod. Det finns specifika modulanvisningar till de komponenter som ska sättas fast i stommen. Följ de dimensioner som tillverkaren gett i monteringsanvisningarna.
4. Kontrollera att utrustningen står rakt och stabilt. För utrustningar med djupt fundament måste man komprimera jorden ordentligt när man fyller igen groparna.
5. Innan utrustningen tas i bruk ska en slutbesiktning i enlighet med protokollet i leveransen utföras. Protokollet måste dokumenteras. Kom ihåg att tillträde till utrustningen måste förhindras tills den är färdig monterad, säker och alla monteringsstillbehör avlägsnats.

1. Use the parts list and the markings on the components to make sure that you have all of the necessary parts.
2. Choose a location for the product, taking into account the safety margins specified in the mounting instructions. When deciding on the orientation of the product, pay attention to potential sun and wind loads. Level the ground and prepare the foundations as instructed. Make sure that the ground underneath the foundations is solidly packed. If necessary, replace soil with wood chips or some other sturdy material. The thickness of the safety surfacing should be calculated using the formula supplied with the mounting instructions.
3. Assemble the frame of the product in accordance with the instructions on page 6. Detailed instructions for the different mounting alternatives are shown in the supplement. Separate instructions are provided for the modular components that will be attached to the frame. Please follow the stated measurements carefully.
4. Make sure that the product is mounted straight and firmly into the ground. Remember to pack the soil carefully when refilling the excavation around deep-mounted structures.
5. Inspect the installation thoroughly using the checklist provided. Document the completed checklist carefully. Remember to stop children from using the product until it has been fully built and safety-tested and all mounting equipment has been cleared away.

1. Überprüfen Sie die Lieferung auf Vollständigkeit, indem Sie das Teileverzeichnis mit der Lieferung abgleichen.
2. Wählen Sie einen Standort für das Gerät und berücksichtigen Sie die vom Hersteller in der Installationsanleitung genannten Sicherheitsabstände. Bei der Ausrichtung des Gerätes beachten Sie den möglichen Einfluss von starker Sonneneinstrahlung oder Wind. Ebenen Sie den Bereich und führen Sie die Fundamentarbeiten nach der Anleitung durch. Stellen Sie sicher, dass der Boden unter den Fundamentteilen ausreichend verdichtet ist. Wenn nötig, muss das Untergrundmaterial durch Split oder ein anderes tragfähiges Material ausgetauscht werden. Die Stärke des stoßdämpfenden Oberflächenmaterials wird auf Grundlage einer Formel berechnet, die im Anhang der Anleitung für die Fundamente dargestellt ist.
3. Die Aufbauanleitung für den Rahmen des Gerätes finden Sie auf Seite 6. Detaillierte Bilder der Installation sind auf gesonderten Anleitungsseiten zusammengestellt, auf denen sie nach ihrer Befestigungsweise geordnet sind. Für die am Geräterahmen befestigten Komponenten gibt es besondere Modulanleitungen. Halten Sie die in der Installationsanleitung vom Hersteller genannten Maße ein.
4. Überprüfen Sie, dass das Gerät in Waage steht und sicher am Boden verankert ist. Bei Geräten mit Tiefenfundamenten muss der Boden beim Auffüllen des Aushubs ausreichend verdichtet oder betoniert werden.
5. Führen Sie eine Inbetriebnahmeüberprüfung entsprechend des im Lieferumfang enthaltenen Protokolls durch, bevor das Gerät benutzt wird. Das Protokoll muss aktenkundig dokumentiert werden. Denken Sie daran, dass der Zugang zum Gerät verhindert werden muss, bis es fertig und sicher ist und alle Installationswerkzeuge entfernt sind.

1. Vérifier à l'aide de la liste des pièces et des numéros de produit marqués sur les pièces que la livraison comprend toutes les pièces nécessaires.
2. Choisir un bon emplacement pour l'équipement, compte tenu des distances de sécurité indiquées par le fabricant dans les instructions de montage. Tenir compte de l'exposition éventuelle aux forts rayons de soleil ou au vent lors du choix du sens de montage de l'équipement. Egaliser la surface de l'emplacement choisi et effectuer les travaux de fondation conformément aux instructions. S'assurer que le sol sous les pièces de fondation a été suffisamment compacté. Si besoin est, le sol de fondation doit être remplacé par des pierres concassées ou un matériau portant similaire. L'épaisseur du matériau de surface anti-choc est calculée selon la formule indiquée à la page supplémentaire des instructions de fondation.
3. Les instructions d'érection de l'ossature de l'équipement sont indiquées à la page 6. Les images détaillées du montage sont adjointes aux pages d'instruction séparées où elles sont groupées selon le mode de fixation. Des instructions modulaires séparées sont données pour les composants à fixer sur l'ossature. Respecter les mesures données par le fabricant dans les instructions de montage.
4. Vérifier que l'équipement est droit et que sa fondation est solide. Dans le cas des équipements dont la fondation se trouve sous le sol, le sol doit être suffisamment compacté lors du remplissage des trous.
5. Effectuer un contrôle de mise en service conforme au procès-verbal compris dans la livraison avant la mise en service de l'équipement. Ce procès-verbal doit être documenté. Ne pas oublier d'empêcher l'accès à l'équipement jusqu'à ce que celui-ci soit prêt et sûr et que tous les outils de montage aient été enlevés.

												
<p>$h < 600$</p> <p>Without movement and therefore without Impact Area</p>	<p>Totally hard surfaces.</p> <p>Note. Lappset does <u>not recommend</u> totally hard surfaces at all.</p>	<p>E.g. concrete or asphalt</p> 										
<p>$h < 600$</p> <p>With movement e.g. rocking</p>	<p>Materials with very limited impact attenuating properties.</p>	<p>E.g. wood</p> 										
<p>$h < 1000$</p>	<p>Materials with significant impact attenuating properties.</p>	<p>fine gravel 0–8 mm</p>  <p>grass</p>  <p>unsorted sand</p> 										
<p>$h < 3000$</p>	<p>Loose fill material</p> <p>E.g. sand/gravel 0,25...8 mm D60/D10<3,0 Woodchips 5...30 mm bark 20...80 mm</p>	 <table data-bbox="1021 1691 1332 1792"> <tr> <td>\underline{S}</td> <td>\underline{h}</td> </tr> <tr> <td>30 cm</td> <td>< 2,0 m</td> </tr> <tr> <td>40 cm</td> <td>< 3,0 m</td> </tr> </table>	\underline{S}	\underline{h}	30 cm	< 2,0 m	40 cm	< 3,0 m				
\underline{S}	\underline{h}											
30 cm	< 2,0 m											
40 cm	< 3,0 m											
	<p>Syntethic granulates</p> <table data-bbox="406 1892 758 2060"> <tr> <td>\underline{S}</td> <td>\underline{h}</td> </tr> <tr> <td>40 mm</td> <td>~> 1,2...1,3 m</td> </tr> <tr> <td>50 mm</td> <td>~> 1,5...1,7 m</td> </tr> <tr> <td>60 mm</td> <td>~> 1,8...2,0 m</td> </tr> <tr> <td>70 mm</td> <td>~> 2,1...2,5 m</td> </tr> </table> <p>Note. For accurate values, see manufacturer's instructions.</p>	\underline{S}	\underline{h}	40 mm	~> 1,2...1,3 m	50 mm	~> 1,5...1,7 m	60 mm	~> 1,8...2,0 m	70 mm	~> 2,1...2,5 m	
\underline{S}	\underline{h}											
40 mm	~> 1,2...1,3 m											
50 mm	~> 1,5...1,7 m											
60 mm	~> 1,8...2,0 m											
70 mm	~> 2,1...2,5 m											

REMOVE SAFETY SURFACE/SAND/GRAVEL
TO CHECK FOUNDATION



REMOVE SAFETY SURFACE/SAND/GRAVEL
TO CHECK FOUNDATION

