

LAPPSET®

SPORT







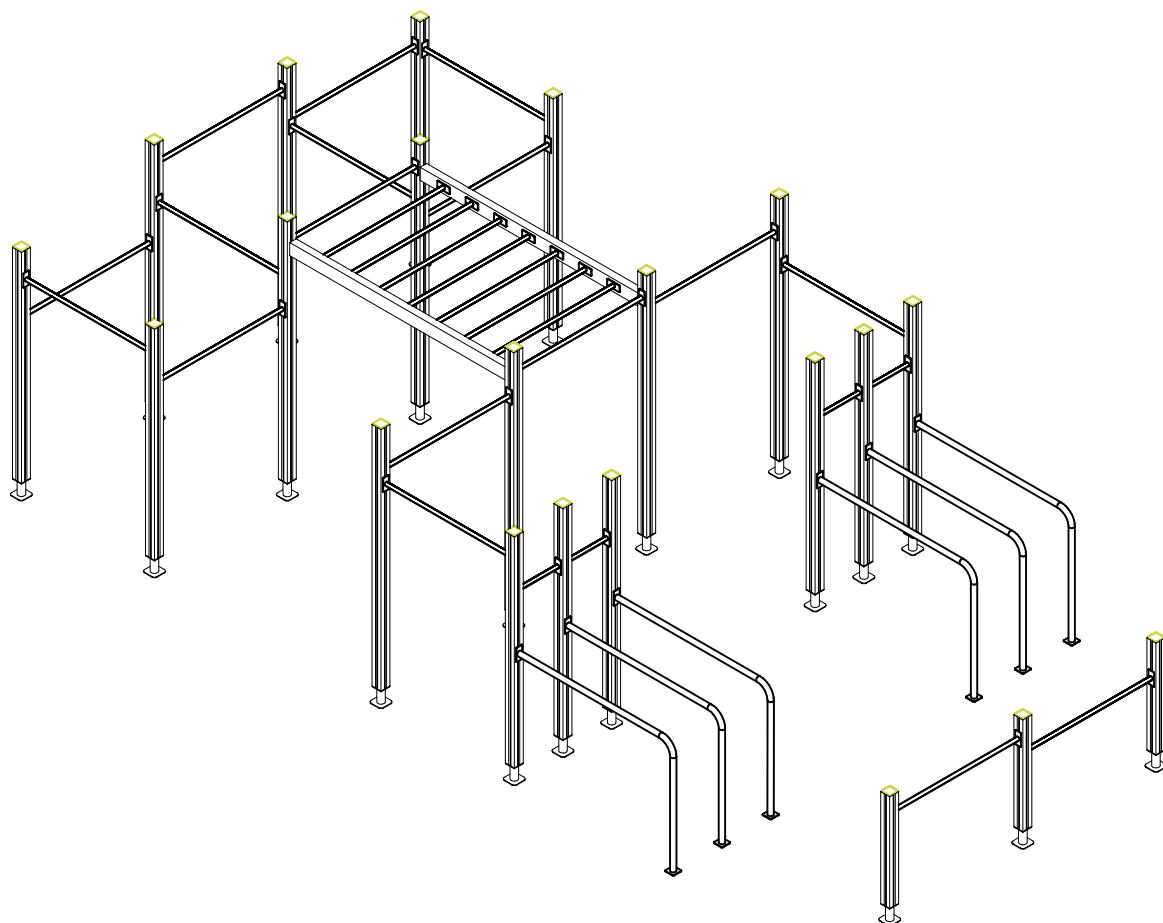

ASENNUSOHJE
MONTERINGSANSVISNING
INSTALLATION INSTRUCTION
AUFBAUANLEITUNG
NOTICE D'INSTALLATION

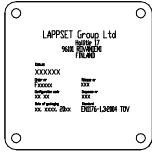
DATE: 13.1.2020

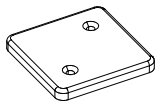
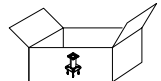
Q12167-6

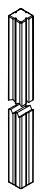
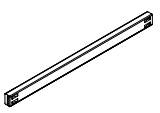
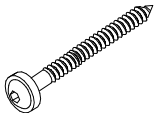
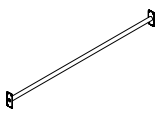
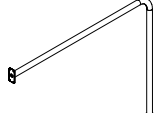
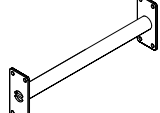
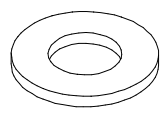
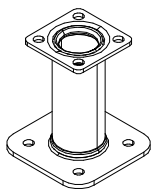

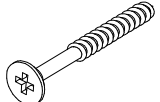
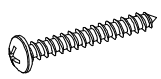
DATE: 13.1.2020

702286  65x65	PCS 1	706466-604  93x93x1025	PCS 3	706481-703  83x83x10	PCS 21	706551  93x93x2120	PCS 21	706598-604  93x93x2120	PCS 10	706669-604  93x93x2400	PCS 8
707294-604  70x120x2304	PCS 2	903093  Ø8x90	PCS 32	908017-217  L 1315	PCS 24	908019-217  1500x1200	PCS 6	908062-217  L 420	PCS 4	909256  Ø16/8.4	PCS 248
909531  130x130x150	PCS 21	909628  M10x100	PCS 24	980107  Ø6x60	PCS 42	980114  Ø4x20	PCS 4	980123  Ø7x60	PCS 224		PCS
	PCS		PCS		PCS		PCS		PCS		PCS
	PCS		PCS		PCS		PCS		PCS		PCS
	PCS		PCS		PCS		PCS		PCS		PCS
	PCS		PCS		PCS		PCS		PCS		PCS

— EN/AS Impact Area 84.9 m²

- - - Falling Space 84.9 m²

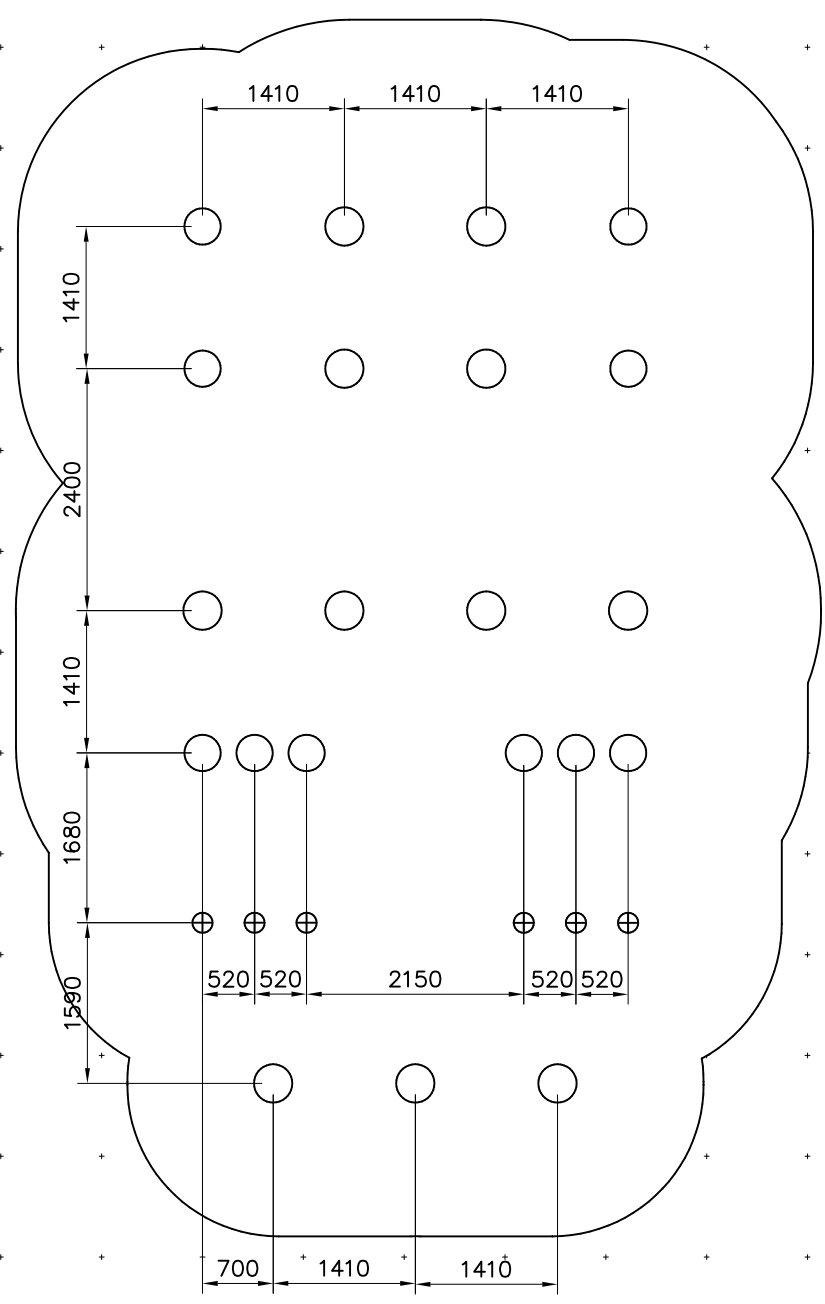
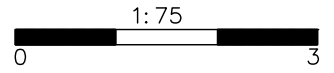

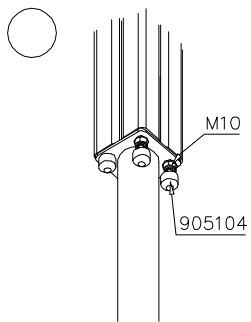

- EN/AS Impact Area 84.9 m²
- - - Falling Space 84.9 m²
Max Falling Height 1350 mm

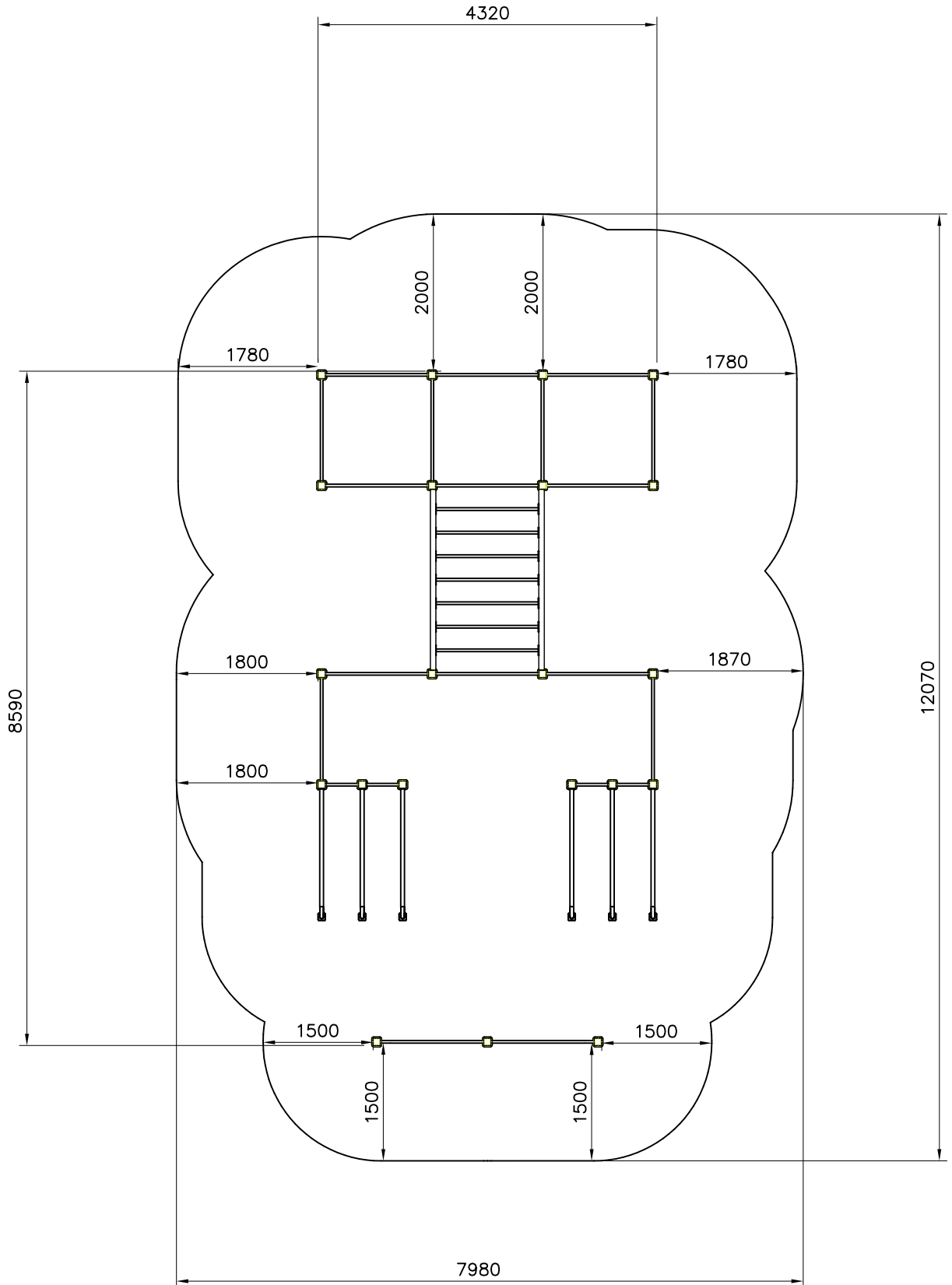
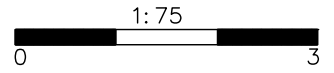

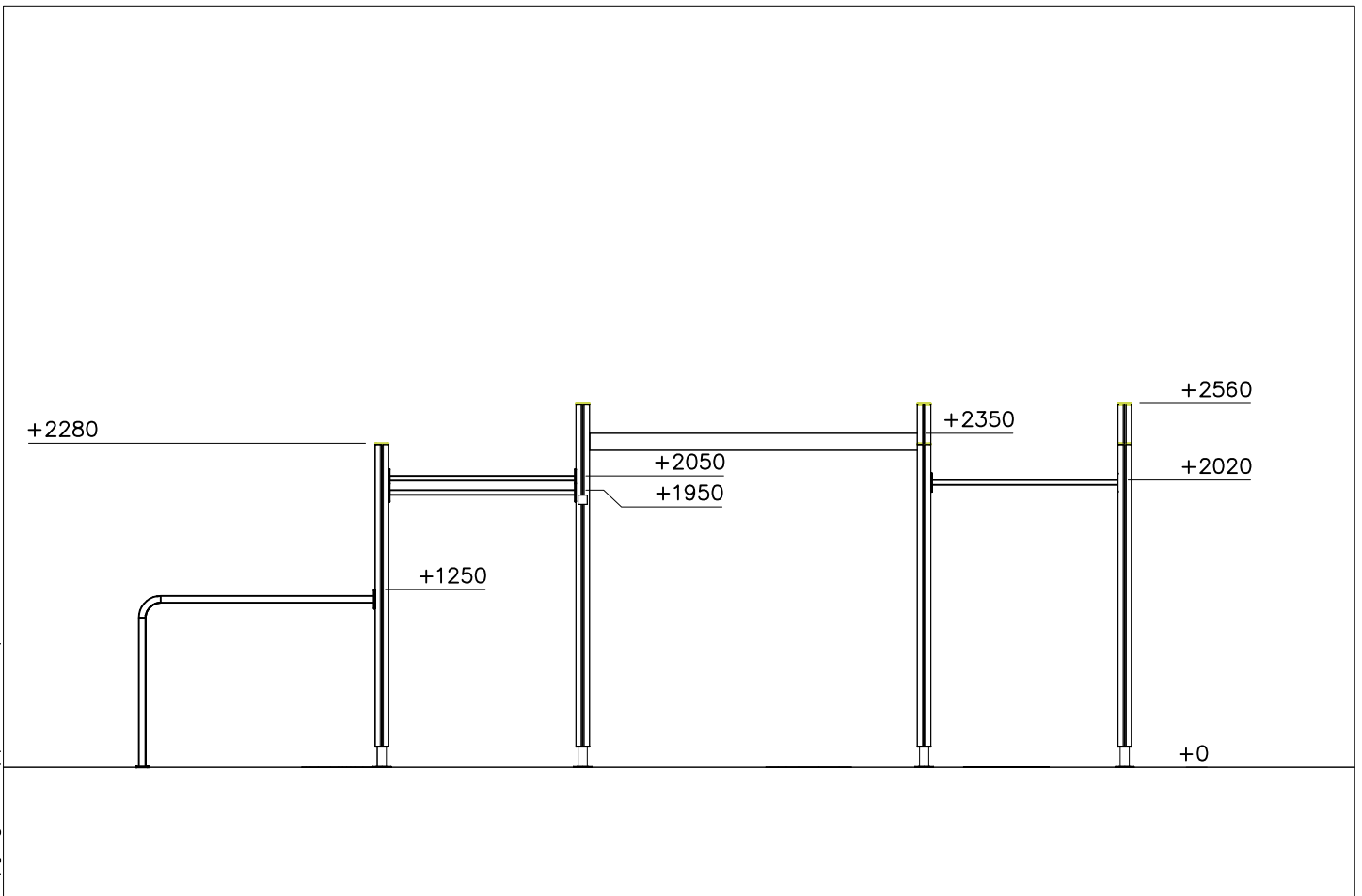
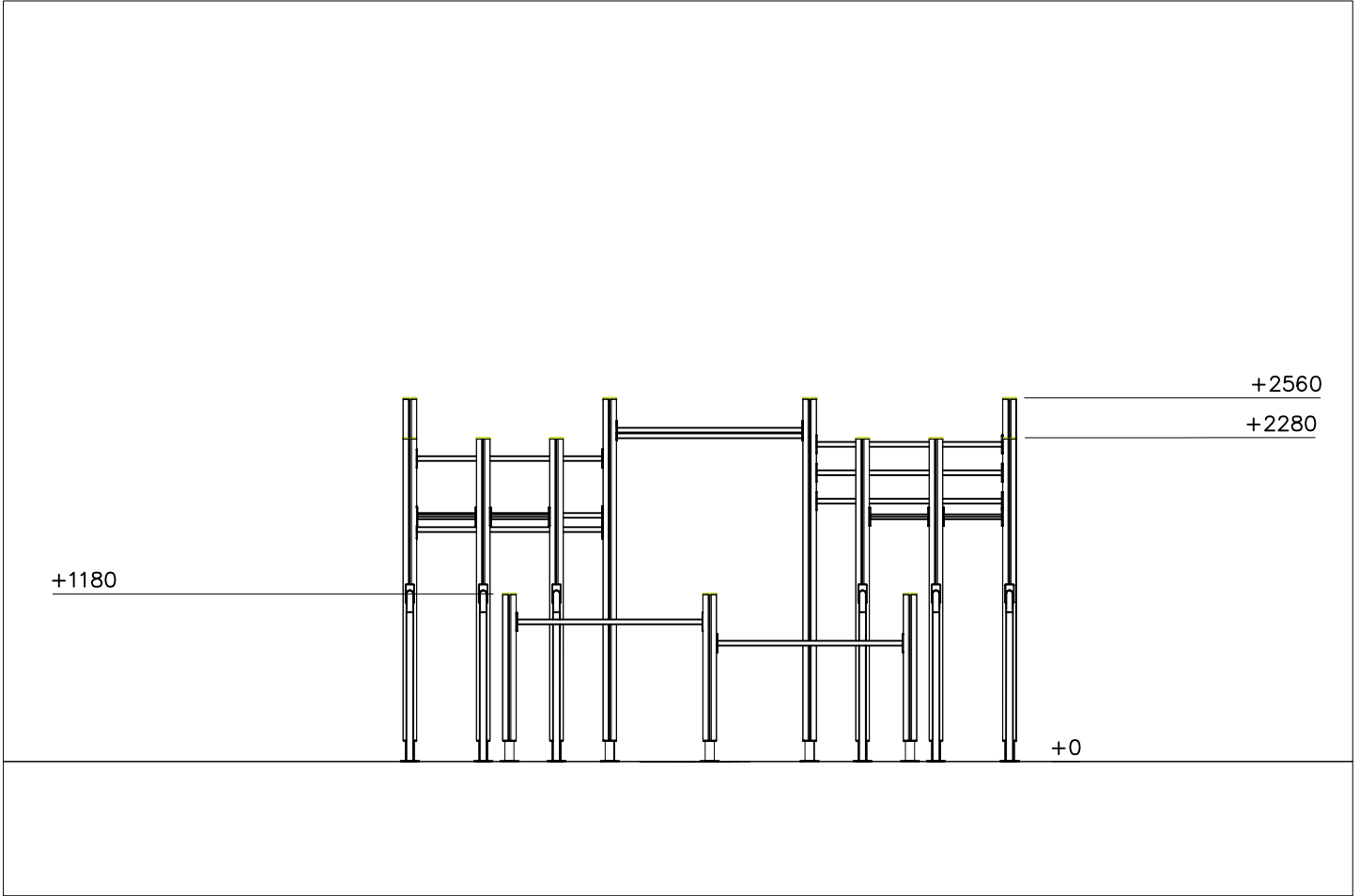

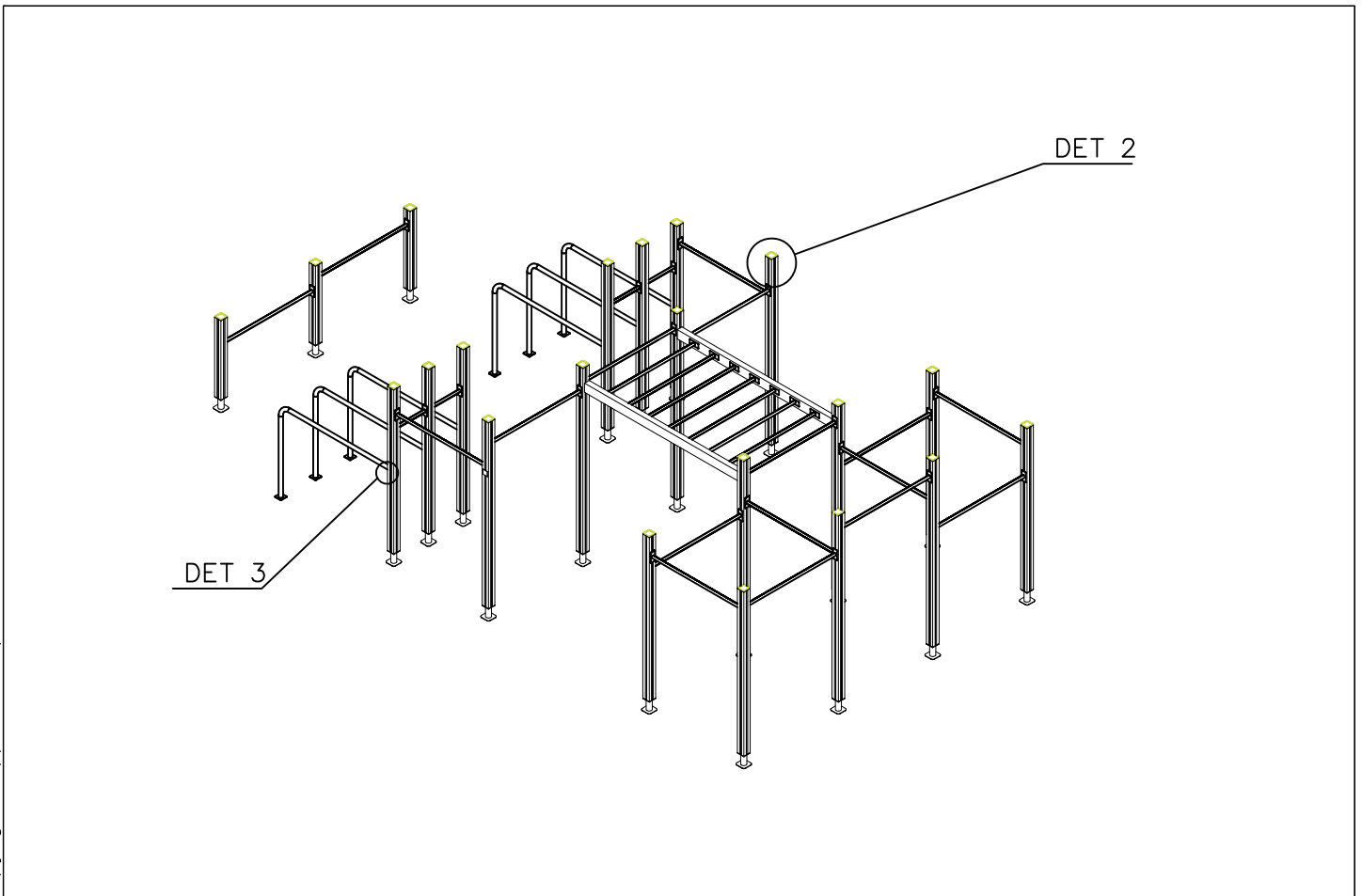
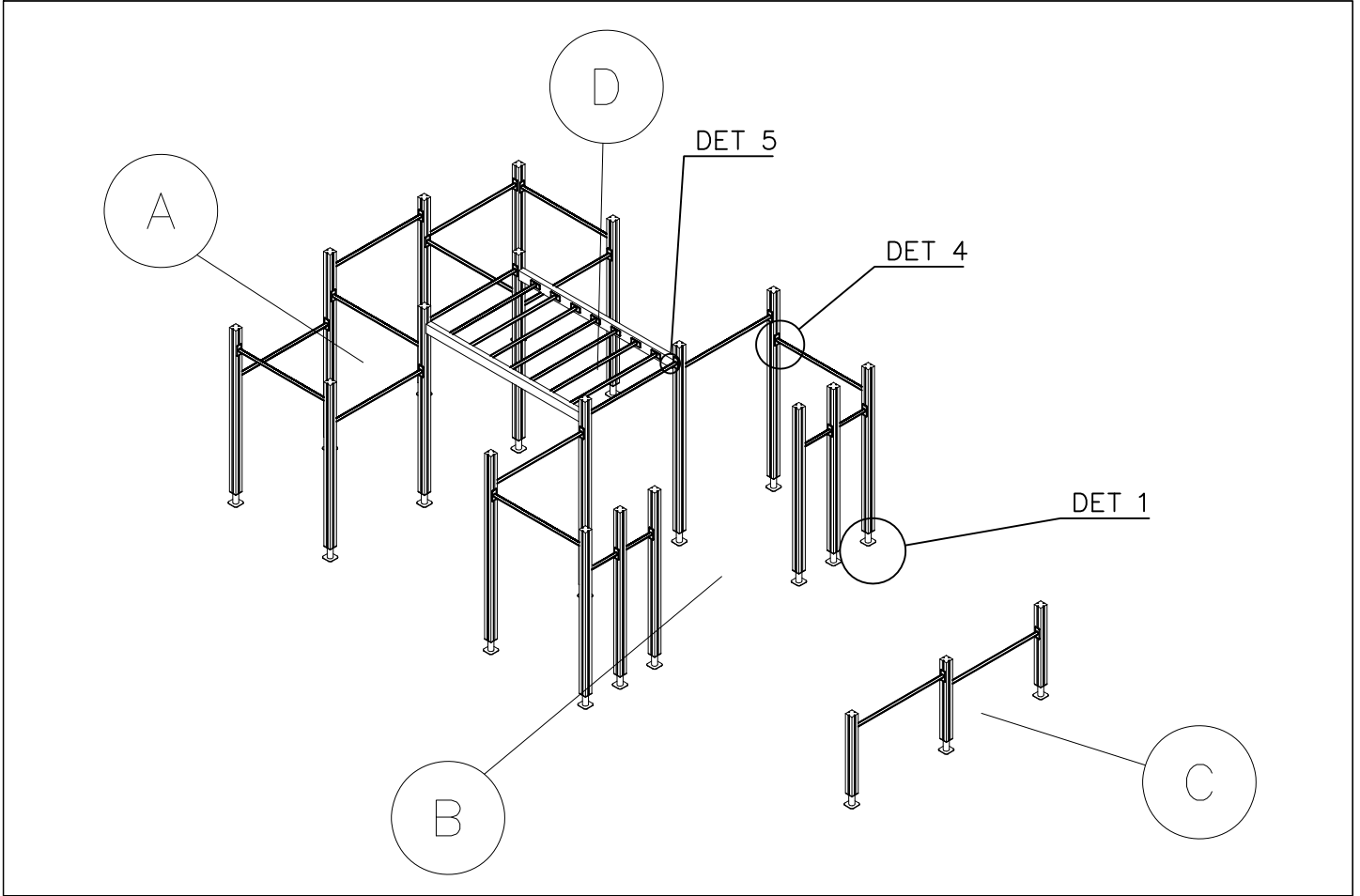

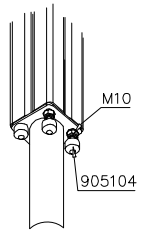
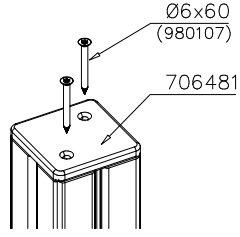
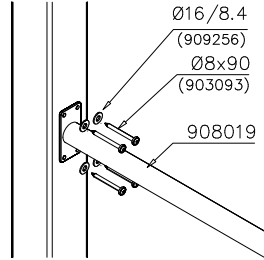
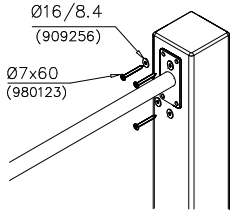
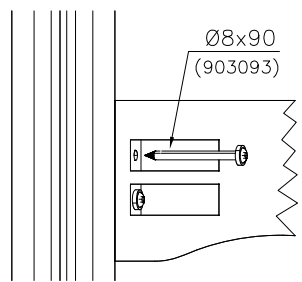
<p>DET 1</p> 	<p>DET 2</p> 	<p>DET 3</p> 	<p>DET 4</p> 
<p>DET 5</p> 			

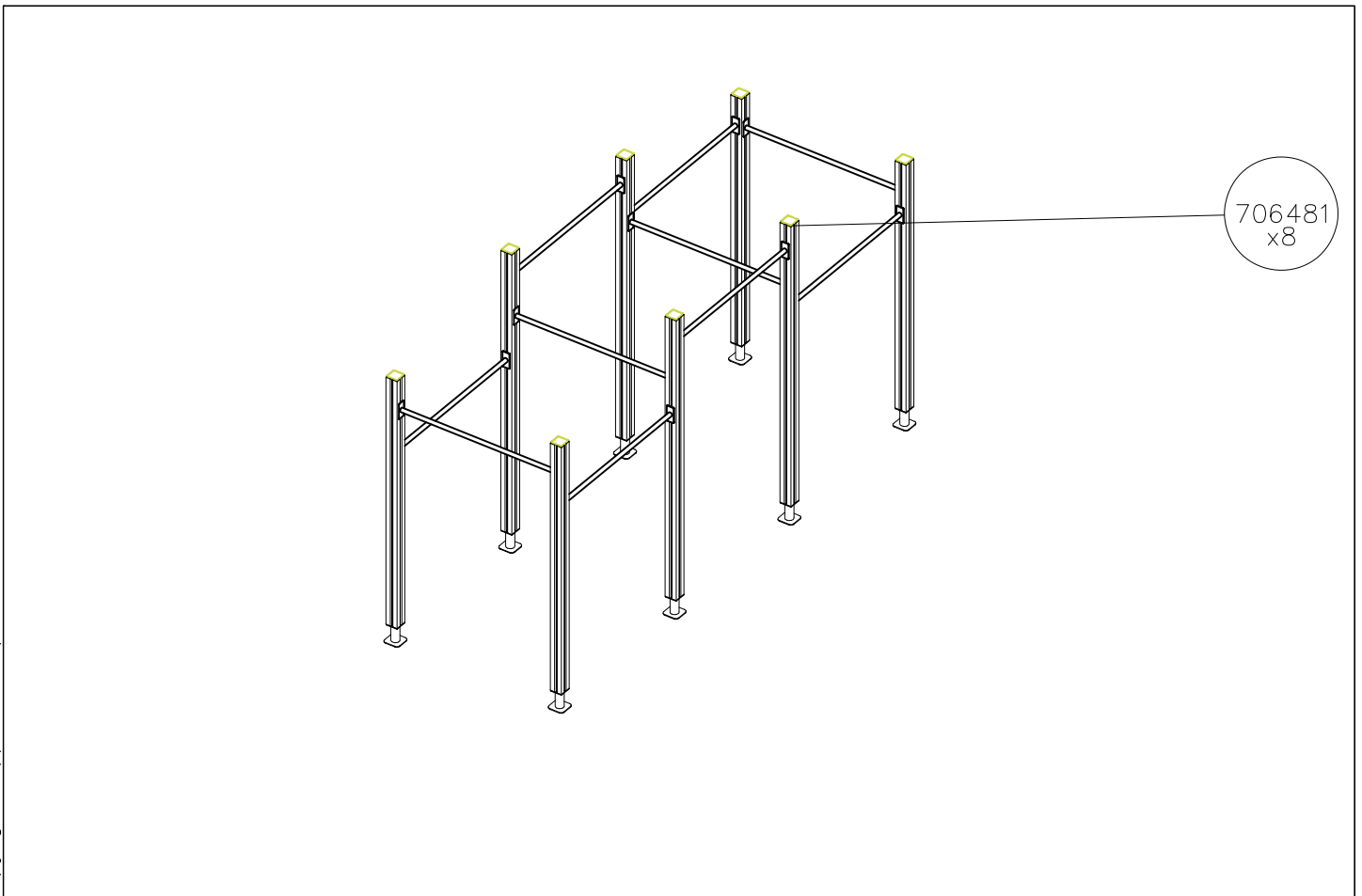
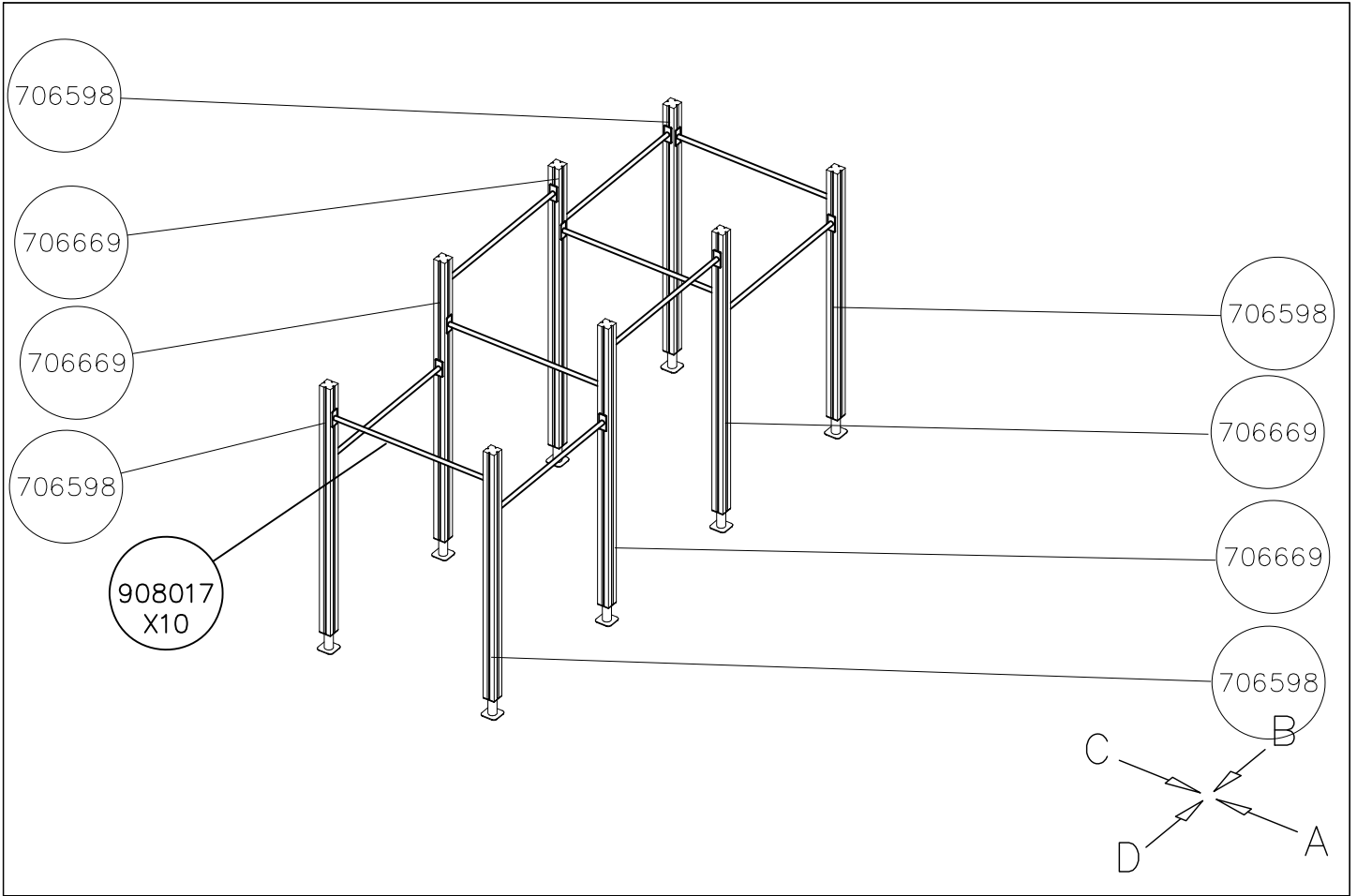

DATE: 13.1.2020

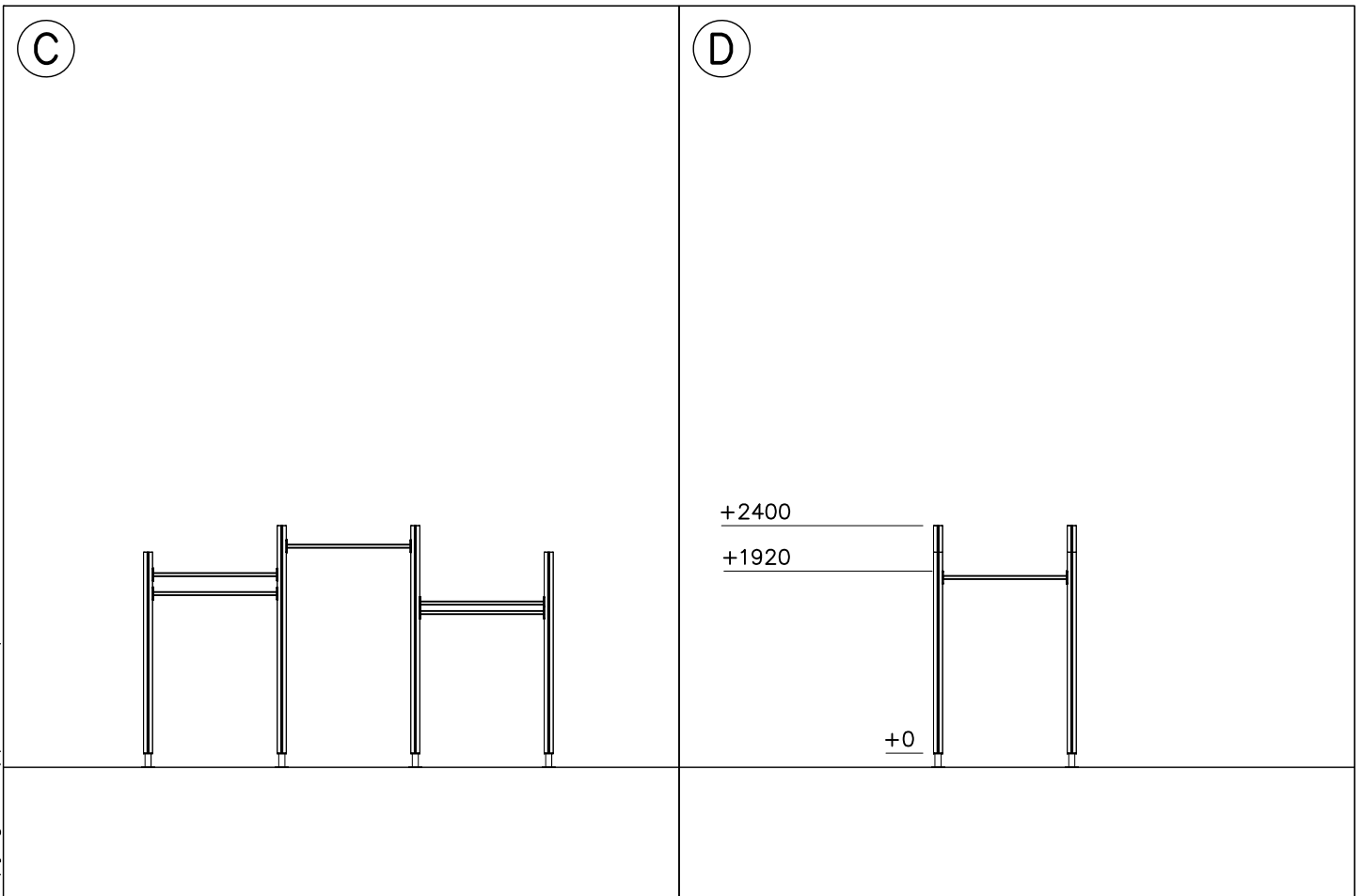
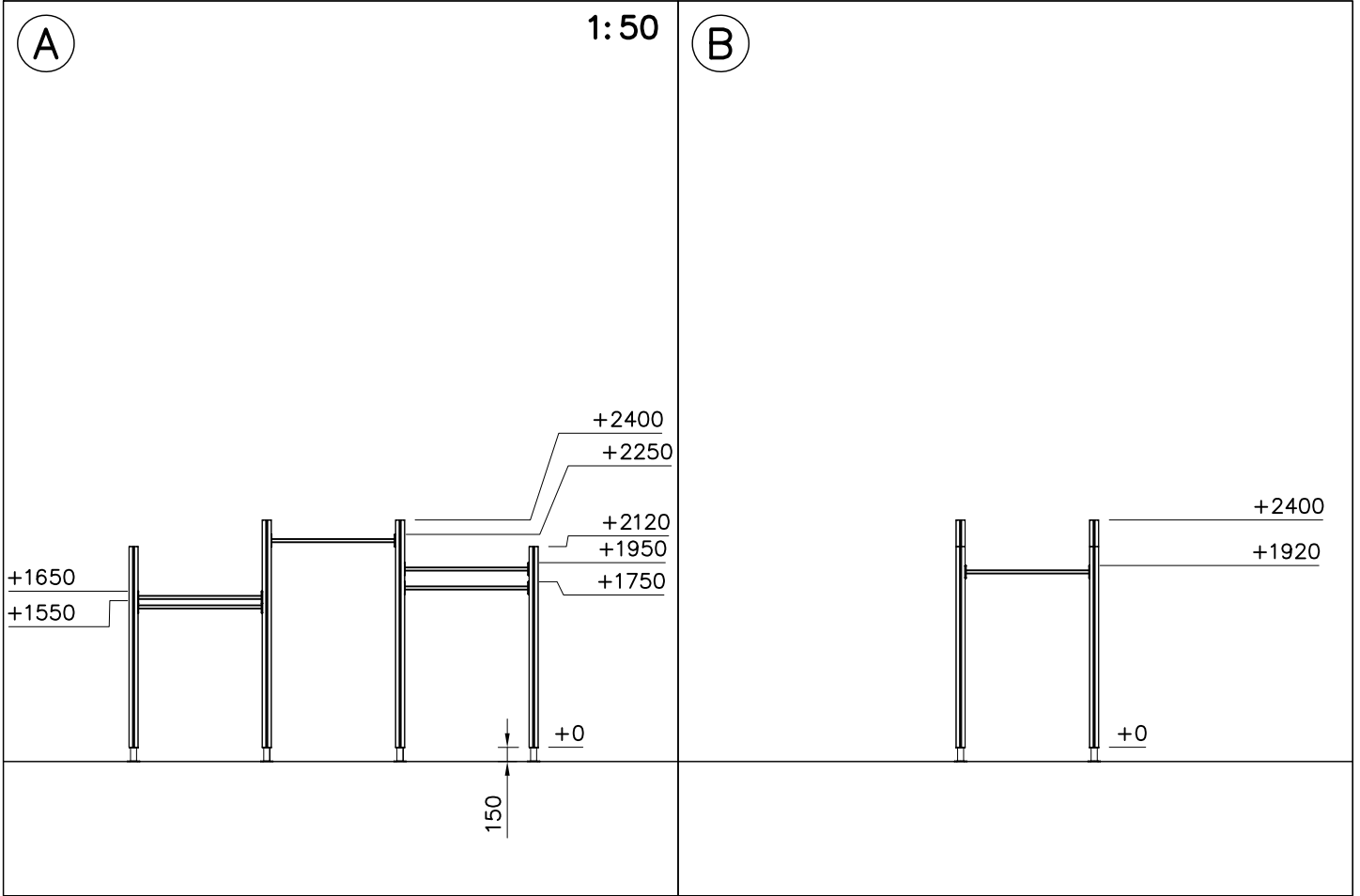

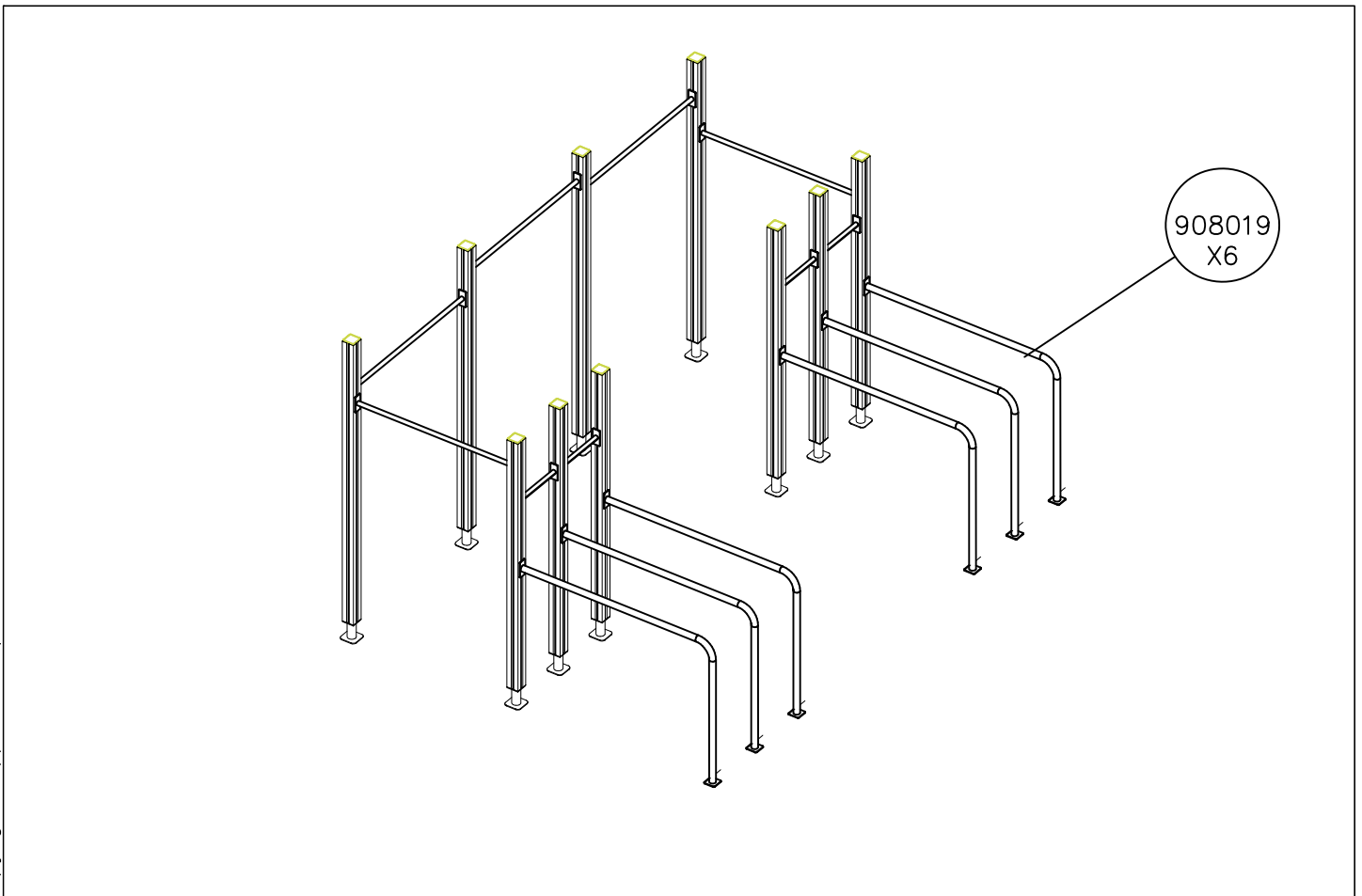
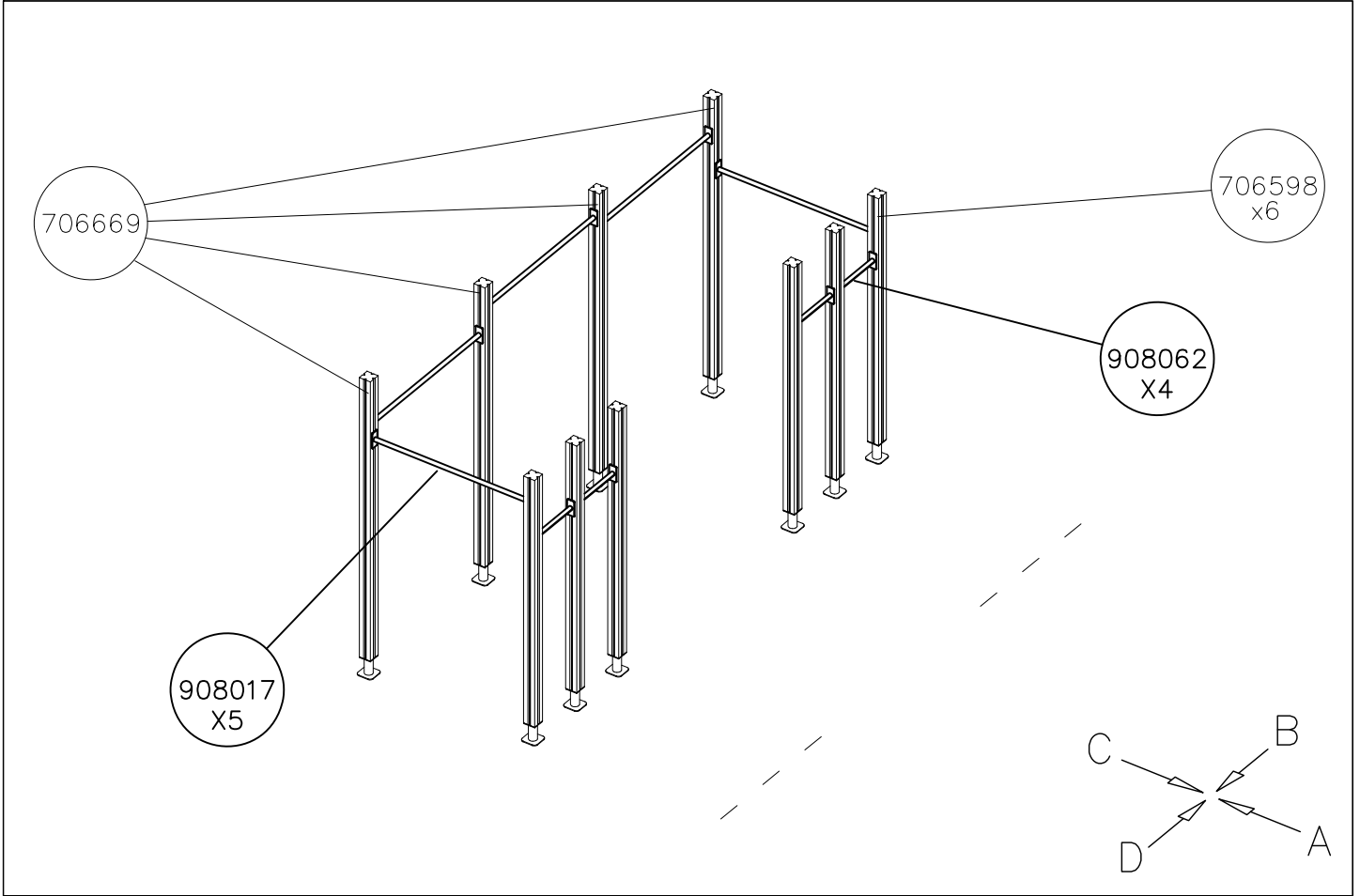

DATE: 13.1.2020

1:50

(A)

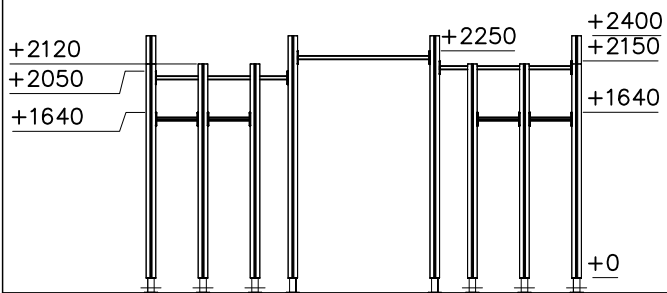

(B)

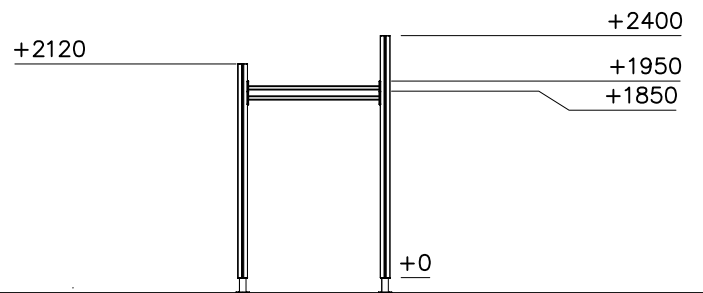

(C)

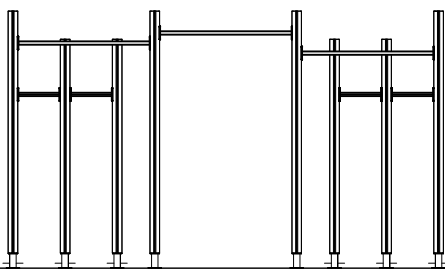

(D)

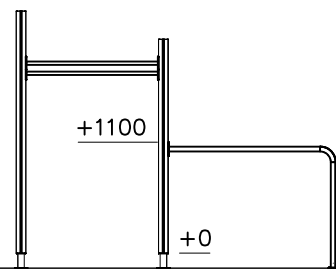

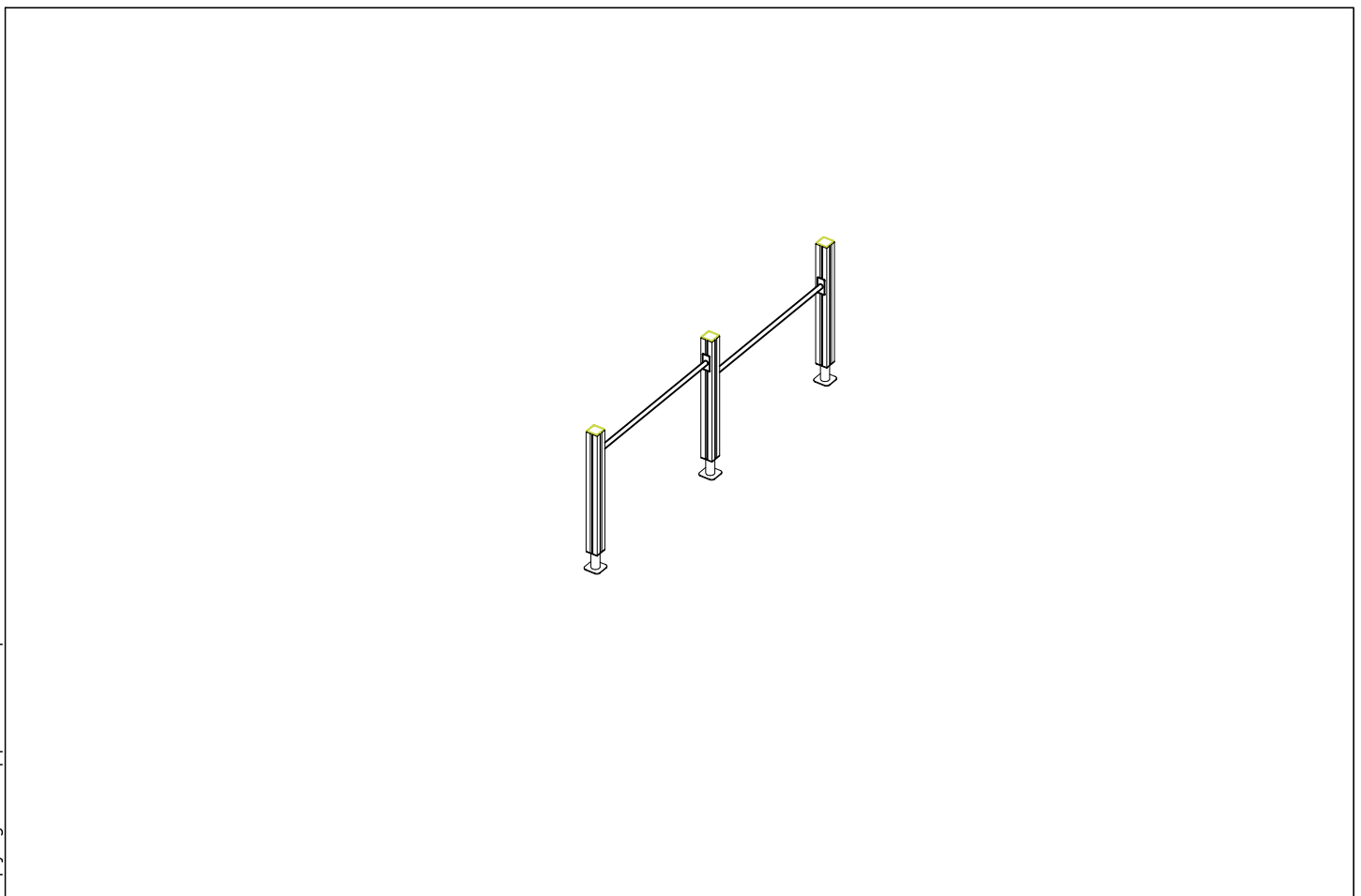
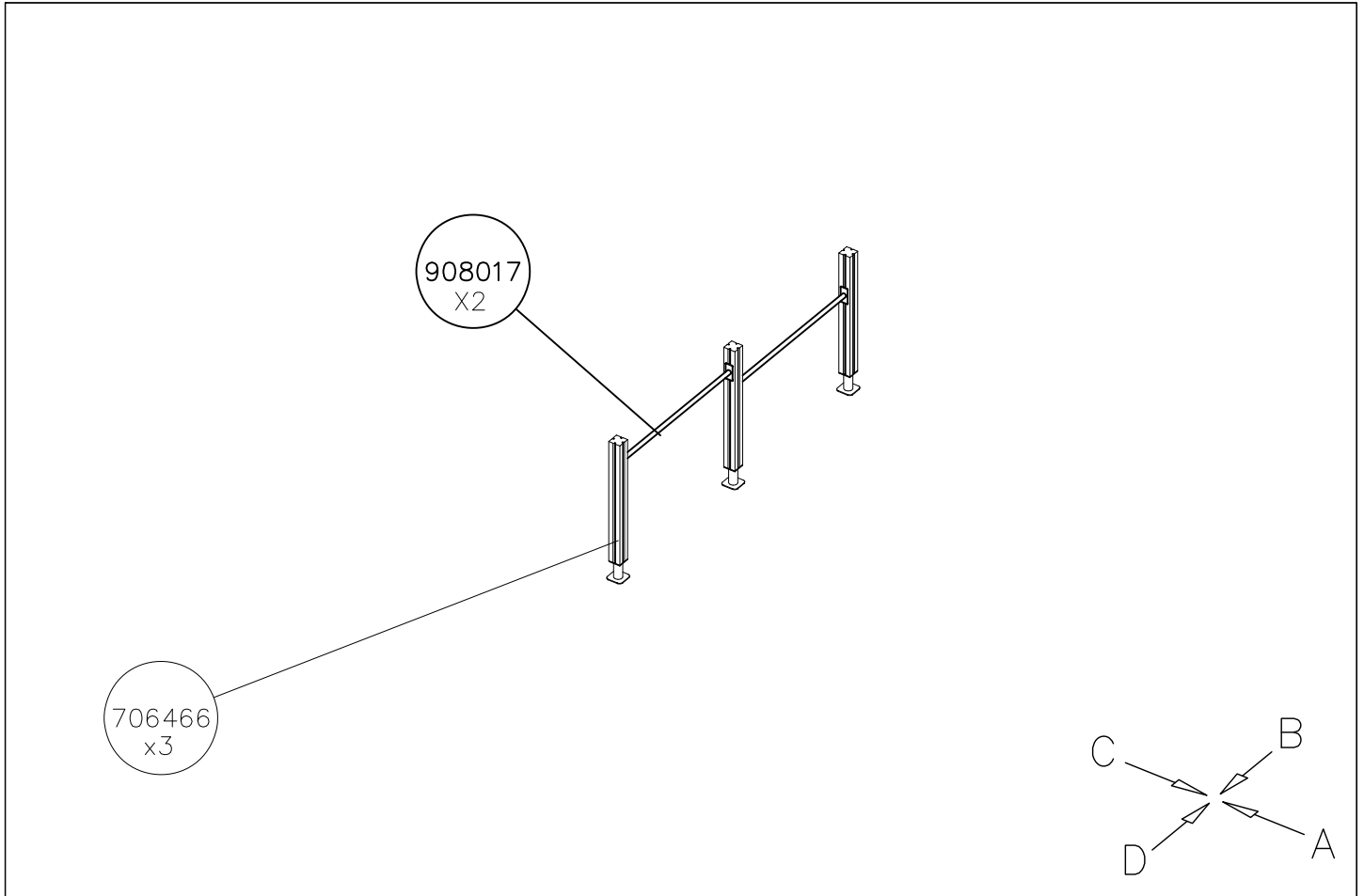

DATE: 13.1.2020

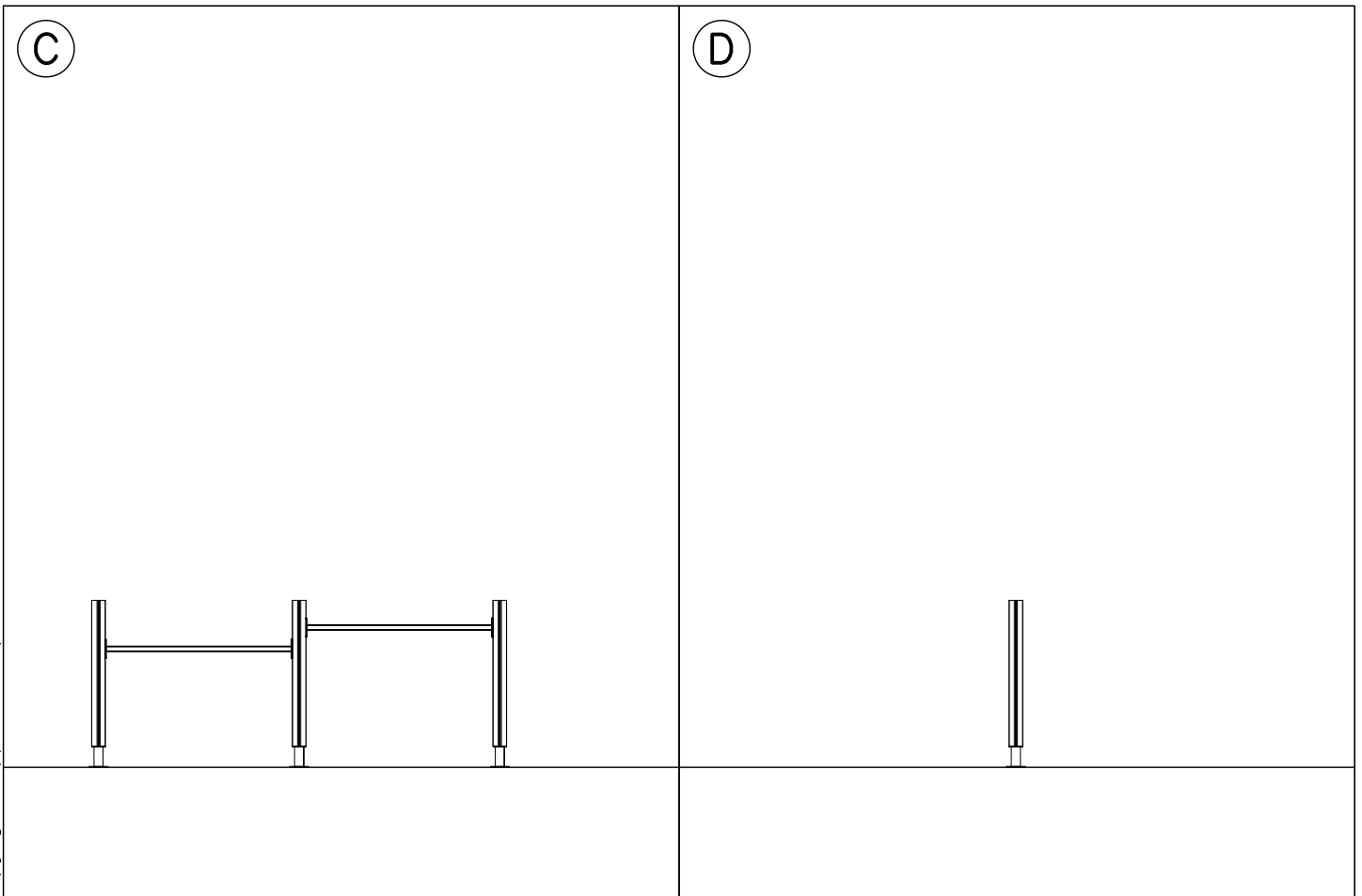
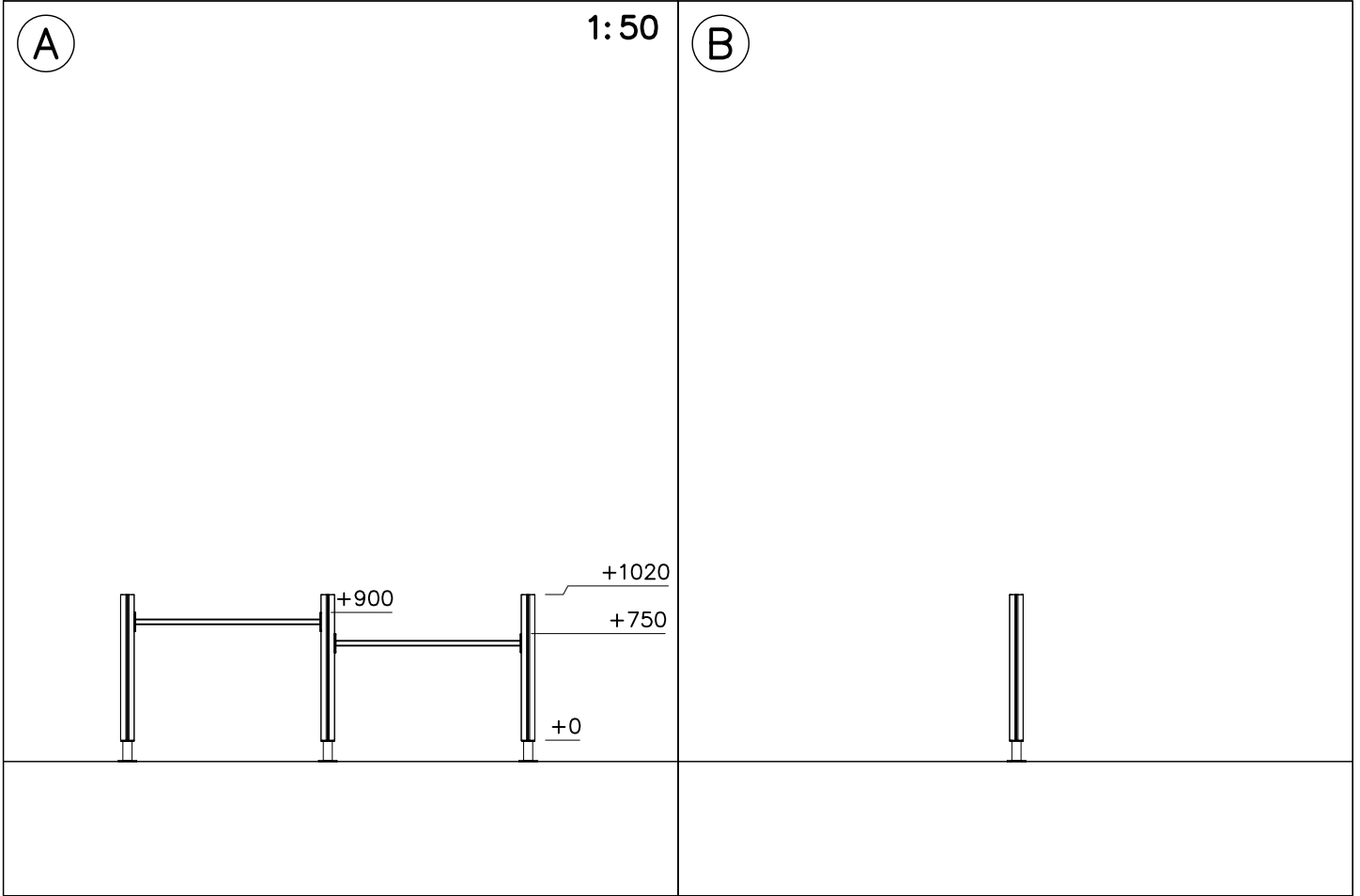

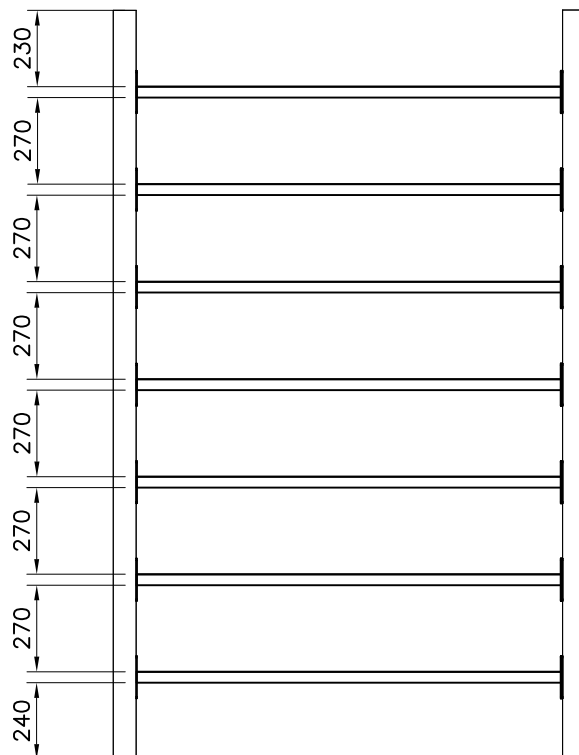
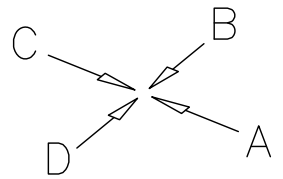
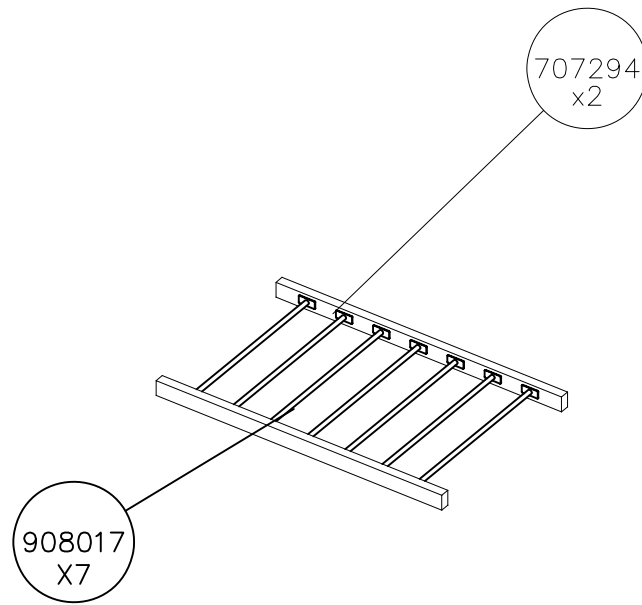

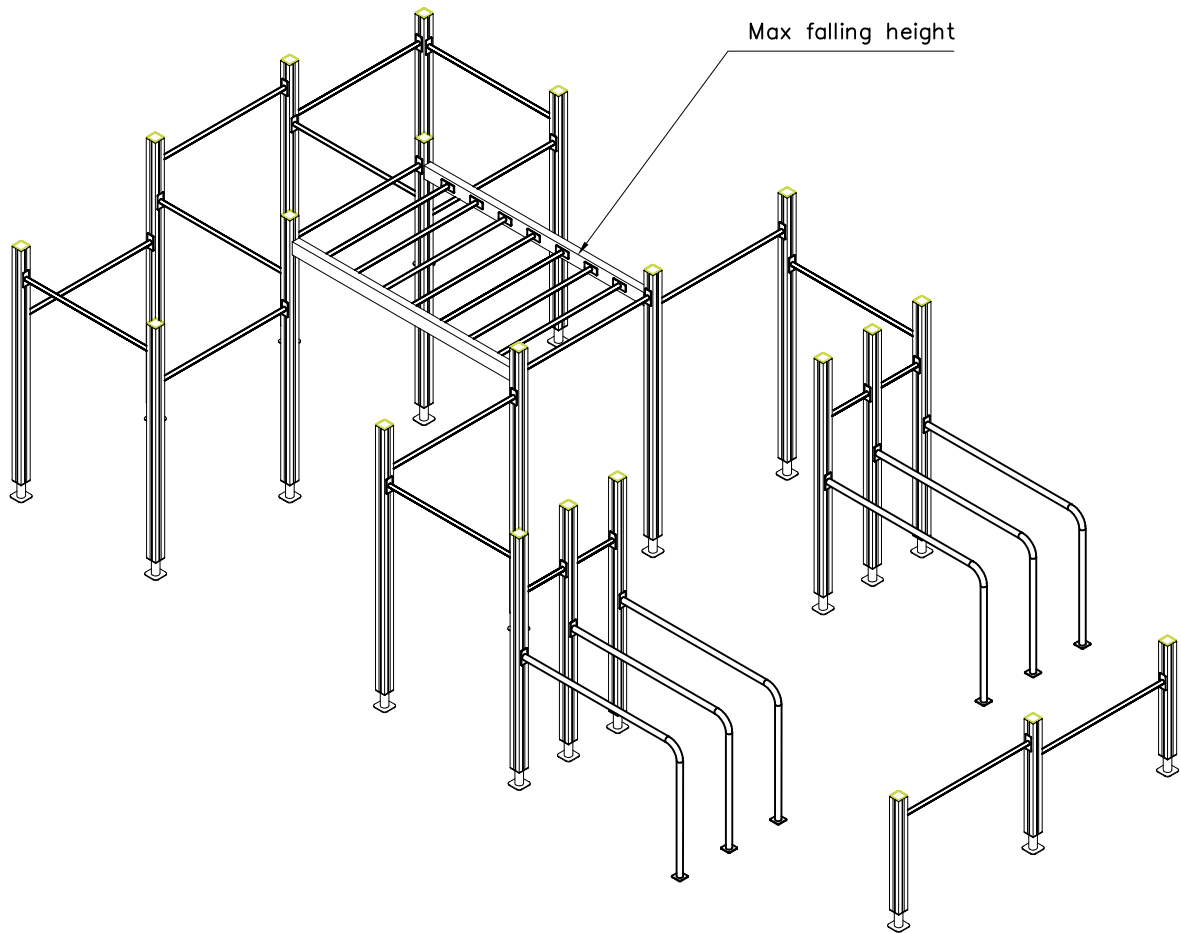

**Tuotekyltti tulee tuotteen mukana yhdellä seuraavista tavoista:****1) Metallinen tuotekyltti ja kiinnitysruuvit**

- Kiinnitä tuotekyltti ruuveilla tolppaan noin 2 metrin korkeuteen kuvan 1 mukaisesti.

2) Tuotekylttitarra

- Puhdista maalattu metalli- tai vaneripinta pölystä ja kosteudesta. Liimaa tarra kuvan 2 mukaisesti.
- Huom. Älä kiinnitä tarraa karheapintaiseen laminaattiin tai maalattuun puuhun.

Vår produktmärkning levereras på ett av följande sätt:**1) Produktskylt i metall**

- Fäst skylten med de medföljande skruvarna

2) Självhäftande produktetikett

- Rengör den pulverlackerade metallytan eller laminatyten så att den blir fri från smuts och fukt. Fäst etiketten enligt fig. 2.
- Obs! Fäst ej etiketten på detaljer med skrovlig yta eller på målat trä.

Product label is delivered by one of following ways:**1) Metal product label and screws**

- Fasten the label with screws.

2) Label sticker

- Clean the painted metal or plywood surface from dirt and moisture. Fasten the sticker as shown in the figure 2.
- Note. Do not attach the sticker to rough surfaced laminate or painted wood.

La plaque d'informations produit est livrée sous l'une de ces 3 formes :**1) Plaque métallique et vis**

- Fixez la plaque à l'aide des vis.

2) Etiquette autocollante

- Avant de coller l'étiquette, nettoyez le composant métallique peint ou la plaque de contreplaqué, de toute saleté. La surface doit être sèche (voir image 2).
- Attention, ne pas coller l'étiquette sur une surface lamellé-collée irrégulière ou sur du bois peint.

Die Auslieferung des Produktaufklebers erfolgt auf eine dieser Arten:**1) Produkt-Schild aus Metall incl. Schrauben**

- Die Befestigung des Schildes erfolgt mittels der Schrauben.

2) Aufkleber

- Entfernen Sie zunächst Schmutz und Feuchtigkeit vom lackierten Metall bzw. von der Holzoberfläche und bringen Sie den Aufkleber wie im Bild oben rechts beschrieben auf den gesäuberten Untergrund auf.
- Beachten Sie: Bringen Sie den Aufkleber nicht auf raues laminiertes oder lackiertes Holz an.

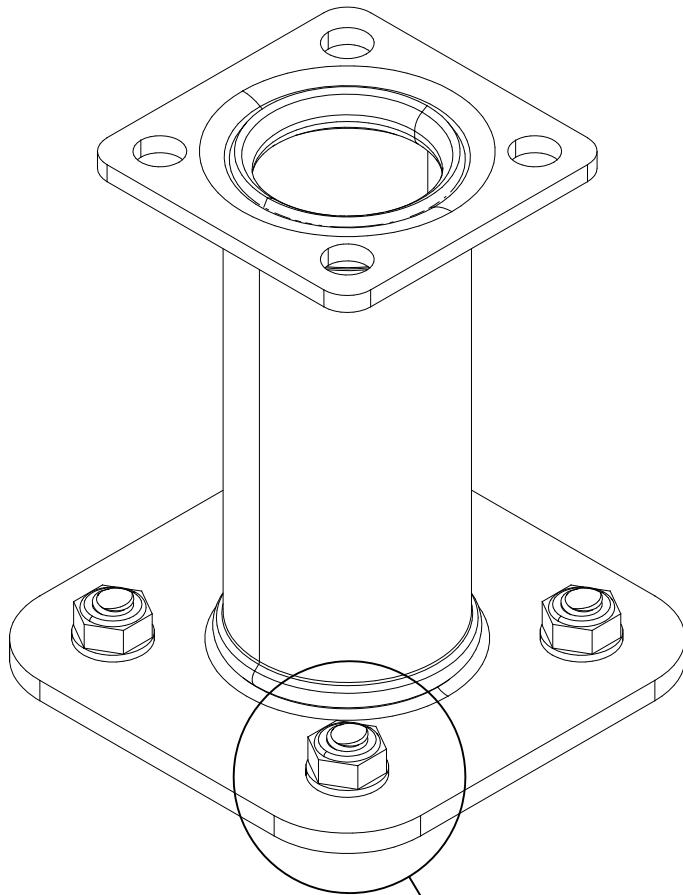

DET 1, 2, 3

① 909531	PCS	① 909513	PCS
	1		1
		60°	
① 909514	PCS	① 902056	PCS
	1		1
		75°	57°
① 902062	PCS		PCS
	1		
		70°	
	PCS		PCS
	PCS		PCS
② 909628	PCS		PCS
	4		
M10x100			

DET 1

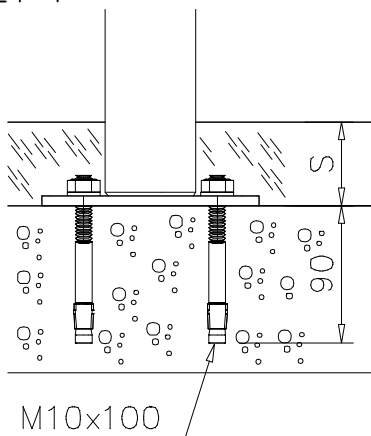

M10x100

DET 2

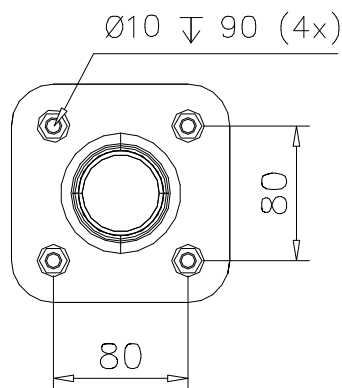

DET 3

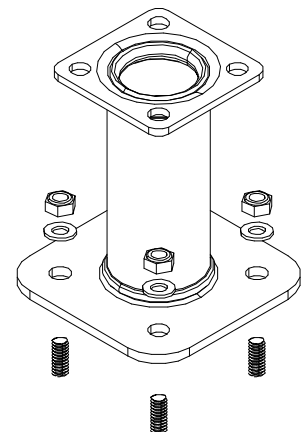

LAPPSET® BETON FOUNDATION

FOOT

DATE: 27.10.2015

1(1)

② 905104	PCS		PCS
	4		
 M10	PCS		PCS



905104