

# **LAPPSET®**

## **SPORT**



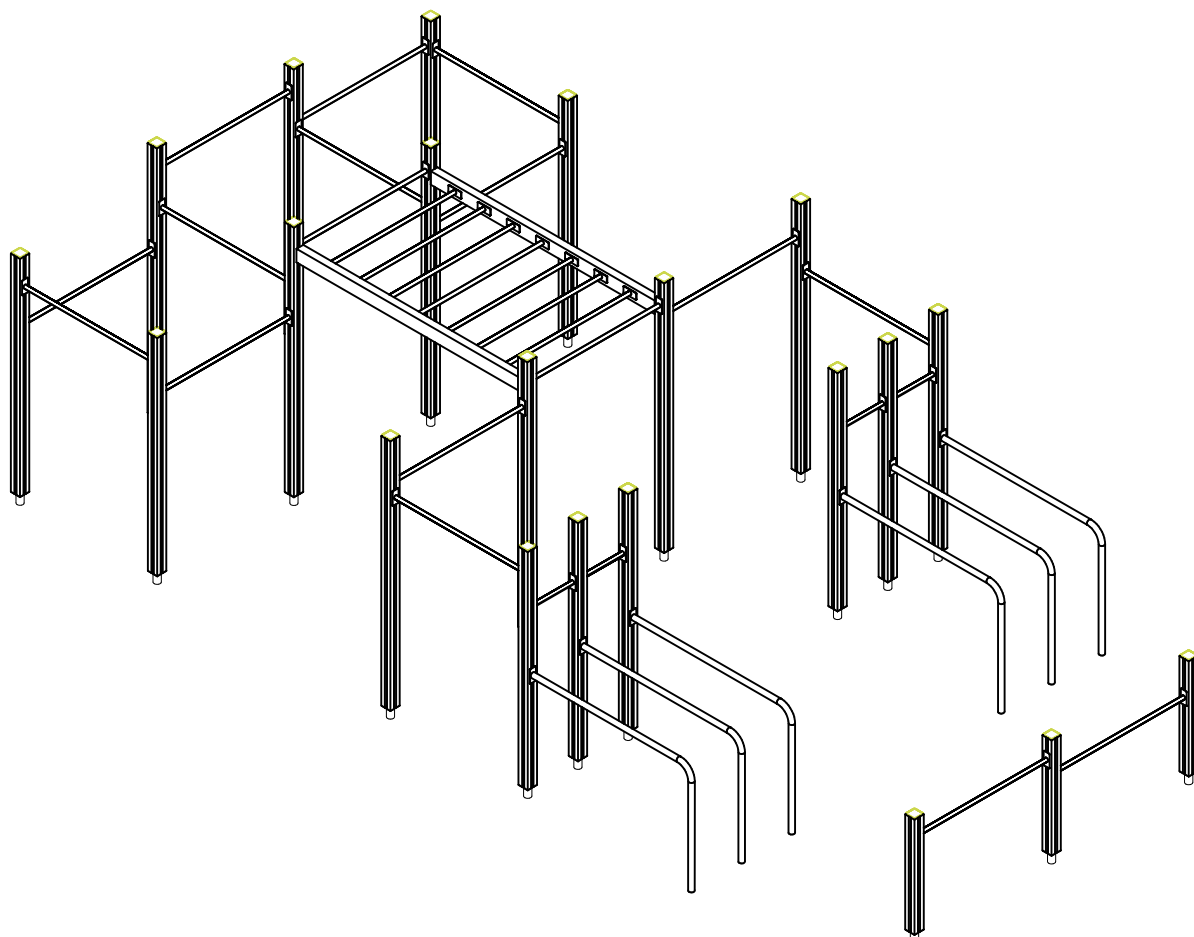

ASENNUSOHJE  
MONTERINGSANSVISNING  
INSTALLATION INSTRUCTION  
AUFBAUANLEITUNG  
NOTICE D'INSTALLATION

DATE: 9.1.2020

### **Q12167-4**

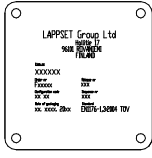

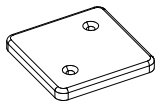
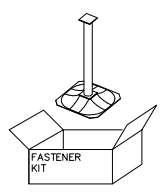
DATE: 9.1.2020

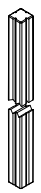
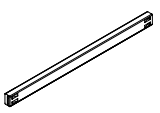
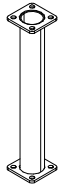
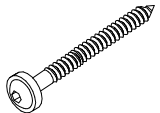
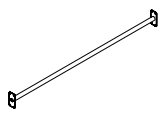
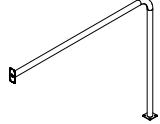
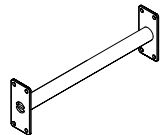
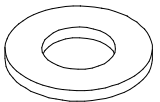
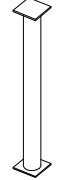
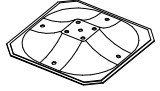
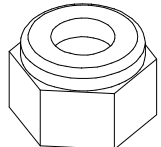
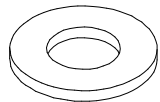
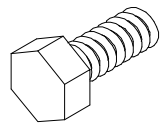
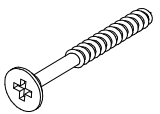
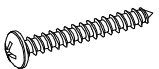
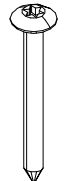
702286  65x65	PCS 1	706466-602  93x93x1025	PCS 3	706481-703  83x83x10	PCS 21	706531  FASTENER KIT	PCS 21	706598-602  93x93x2120	PCS 10	706669-602  93x93x2400	PCS 8
707294-602  70x120x2304	PCS 2	902272  90x90x450	PCS 6	903093  Ø8x90	PCS 32	908017-217  L 1315	PCS 24	908019-217  1500x1200	PCS 6	908062-217  L 420	PCS 4
909256  Ø16/8.4	PCS 248	909511  90x90x650	PCS 21	909519  50x380x380	PCS 21	909637  M10	PCS 24	909638  Ø20/10.5	PCS 48	909639  M10x25	PCS 24
980107  Ø6x60	PCS 42	980114  Ø4x20	PCS 4	980123  Ø7x60	PCS 224		PCS		PCS		PCS
	PCS		PCS		PCS		PCS		PCS		PCS
	PCS		PCS		PCS		PCS		PCS		PCS

- EN/AS Impact Area 84.9 m<sup>2</sup>
- Falling Space 84.9 m<sup>2</sup>
- + Max+Falling Height 1300 mm +

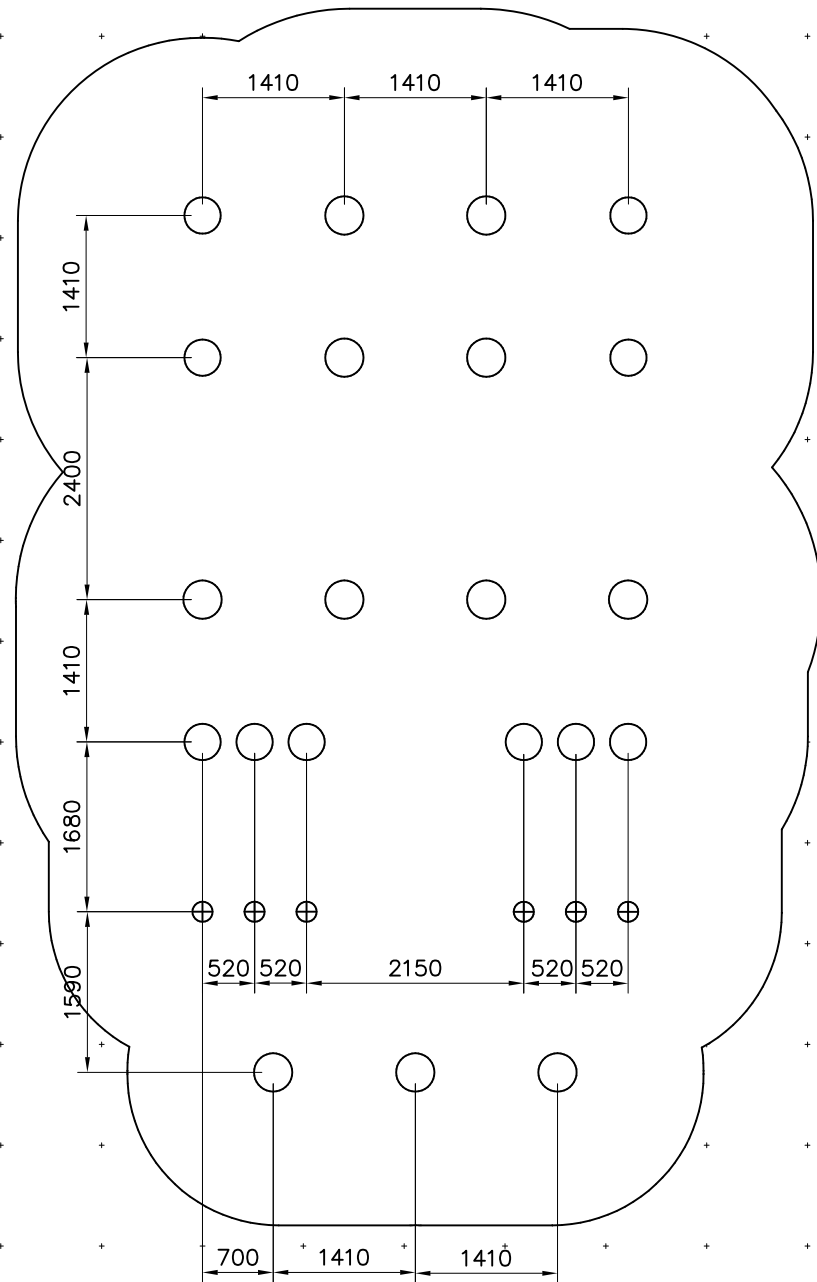
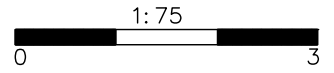

- EN/AS Impact Area 84.9 m<sup>2</sup>
- - - Falling Space 84.9 m<sup>2</sup>  
Max Falling Height 1300 mm

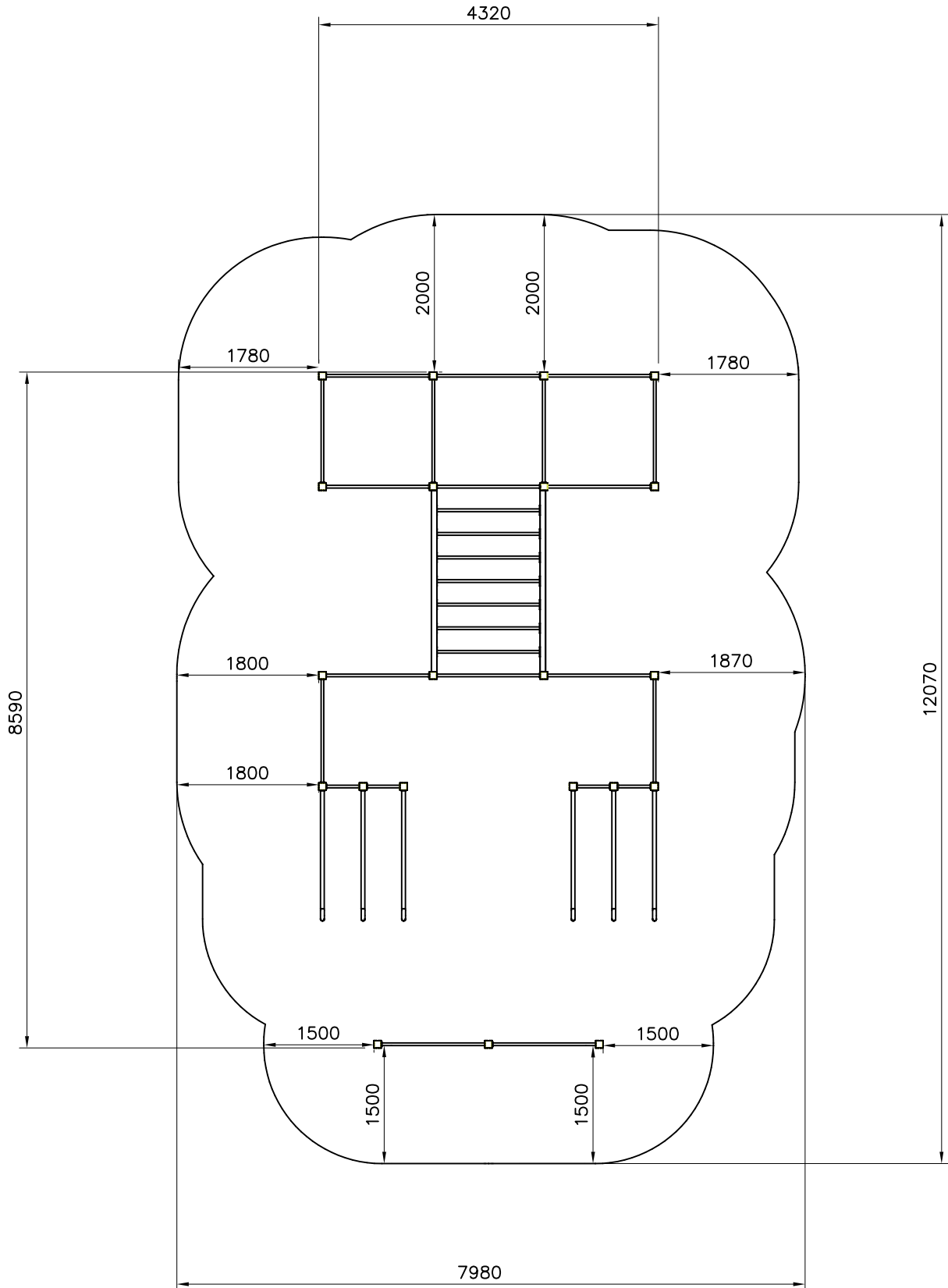
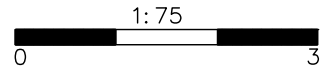

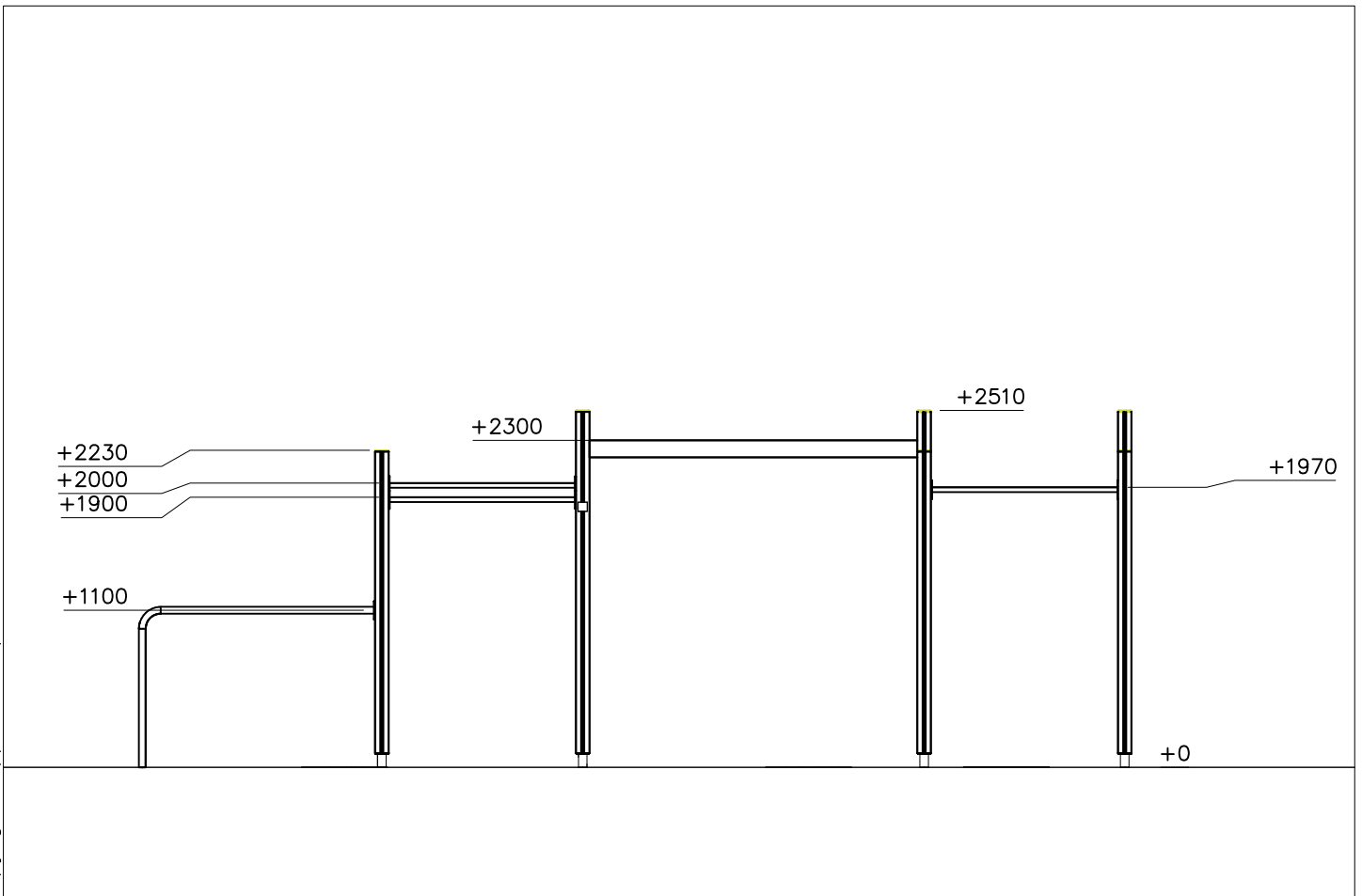
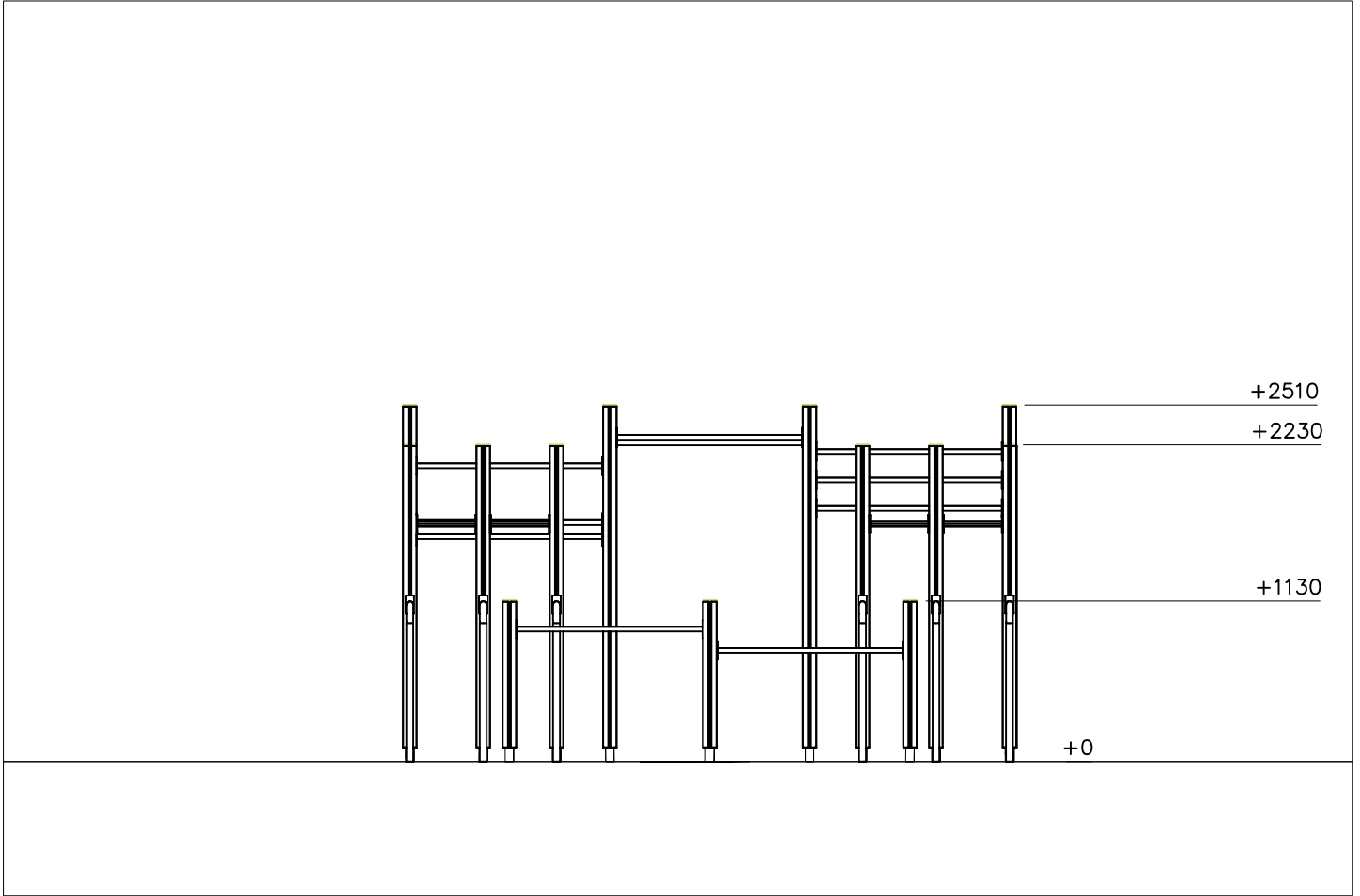

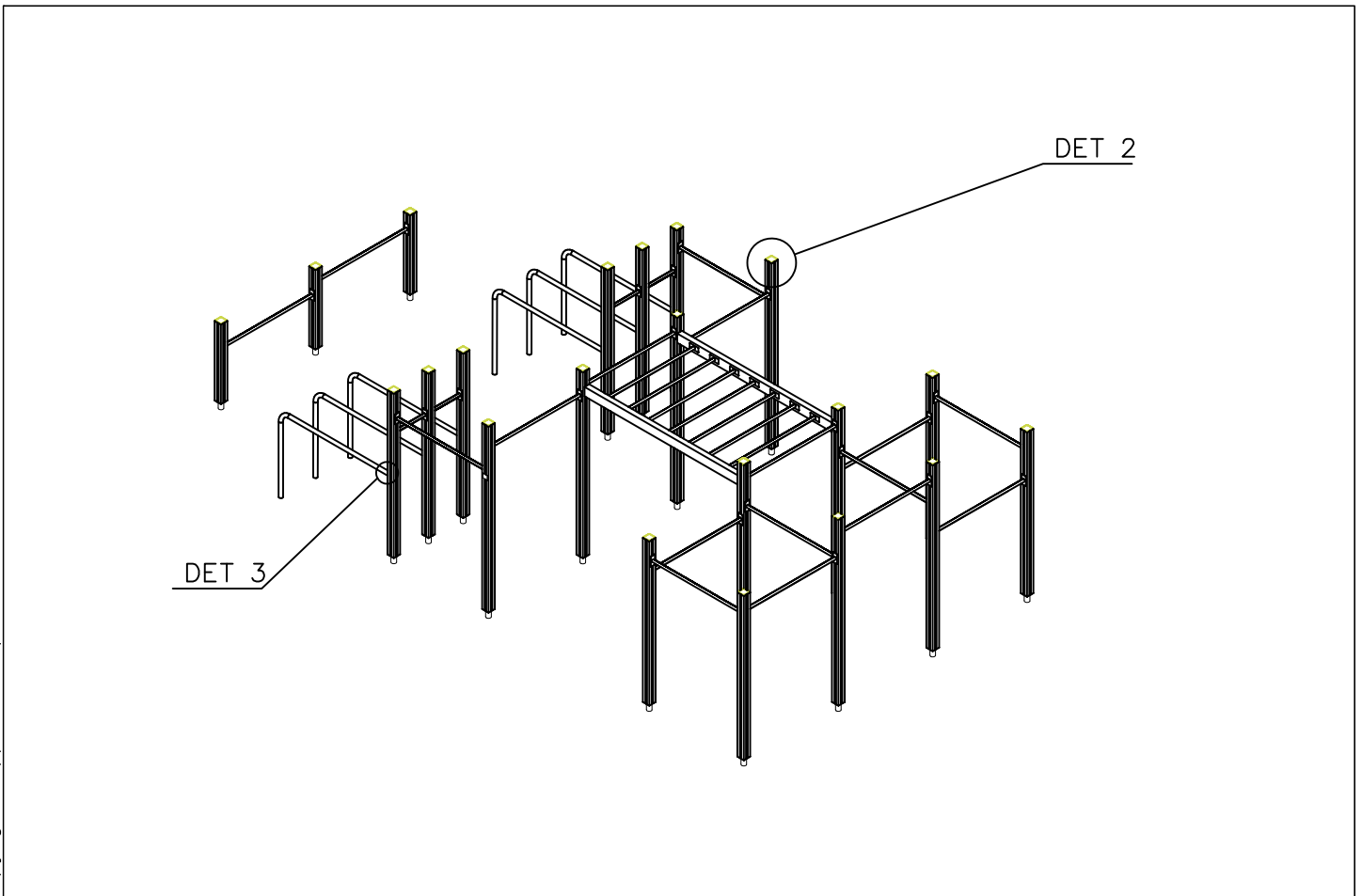
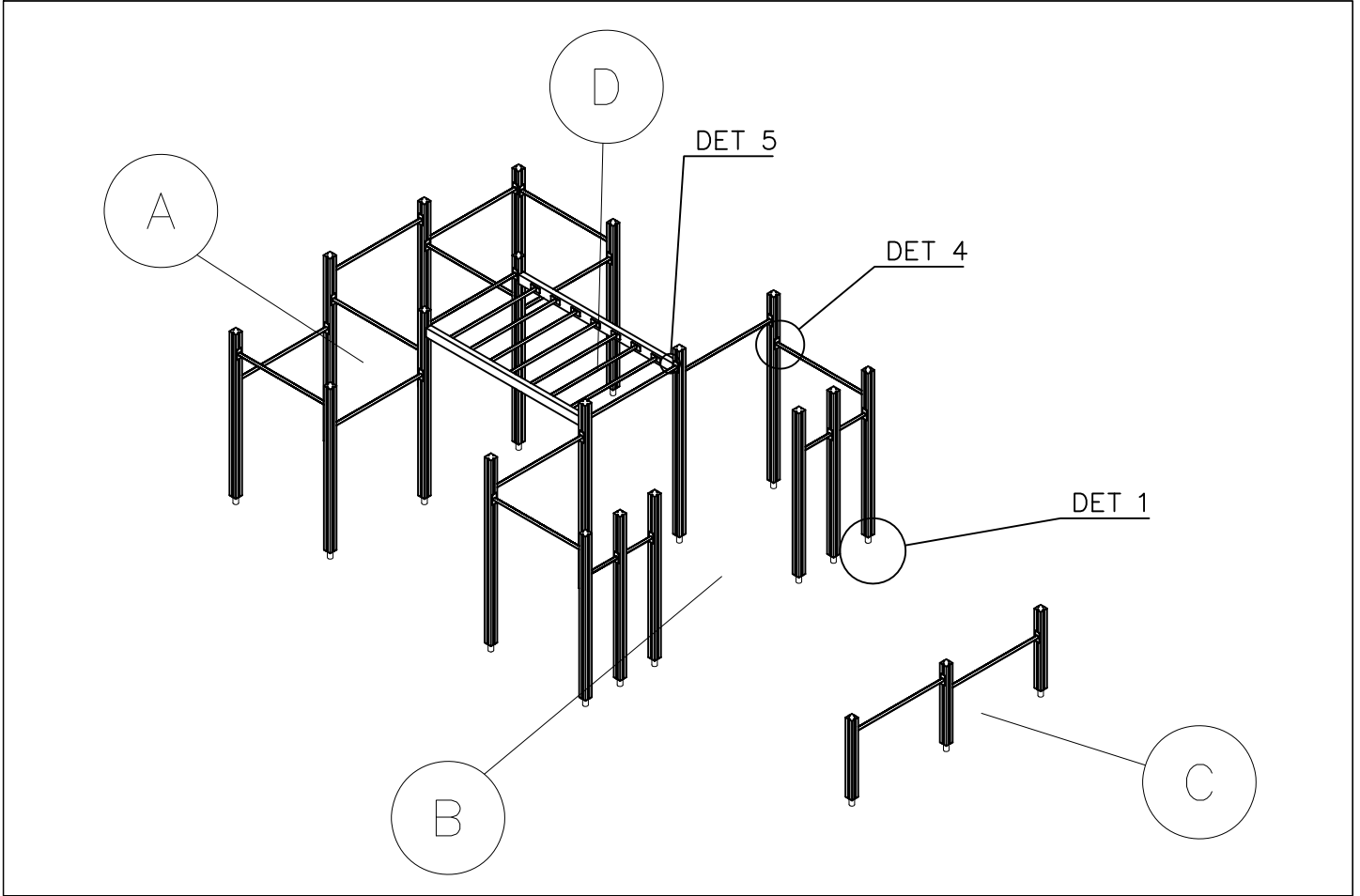

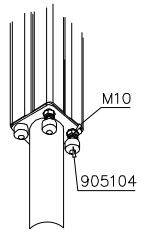
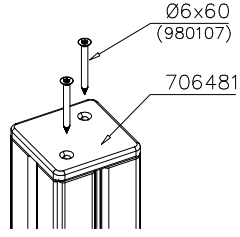
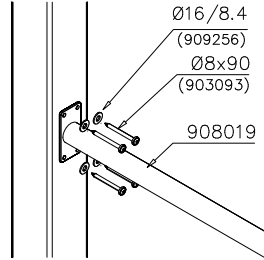
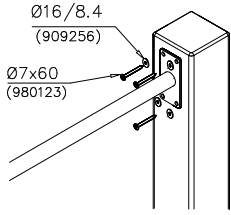
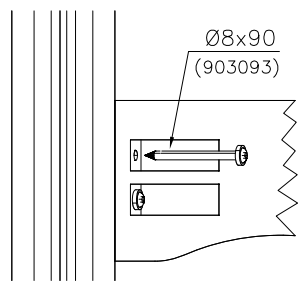
<p>DET 1</p> 	<p>DET 2</p> 	<p>DET 3</p> 	<p>DET 4</p> 
<p>DET 5</p> 			

DATE: 9.1.2020

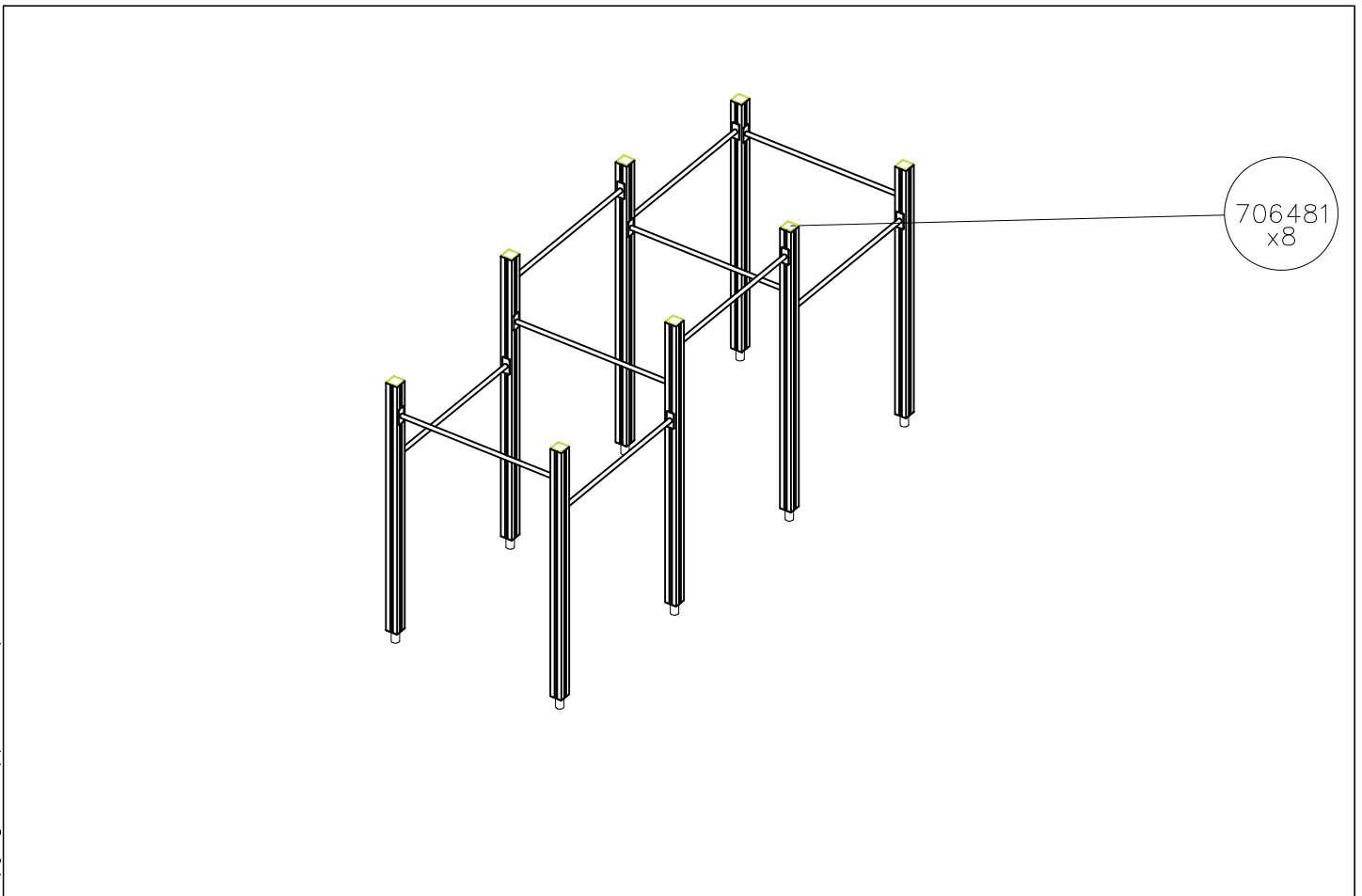
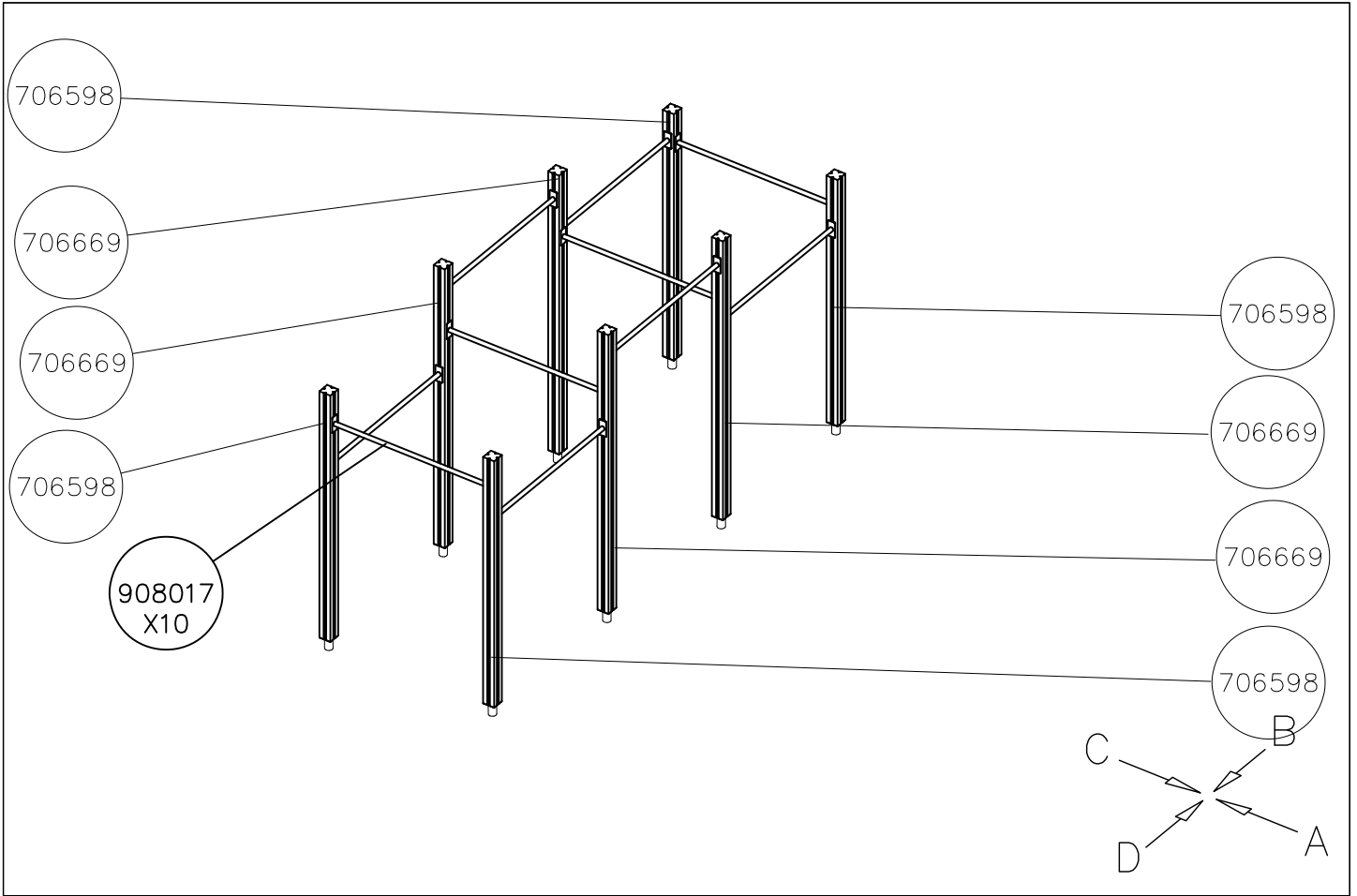



DATE: 9.1.2020

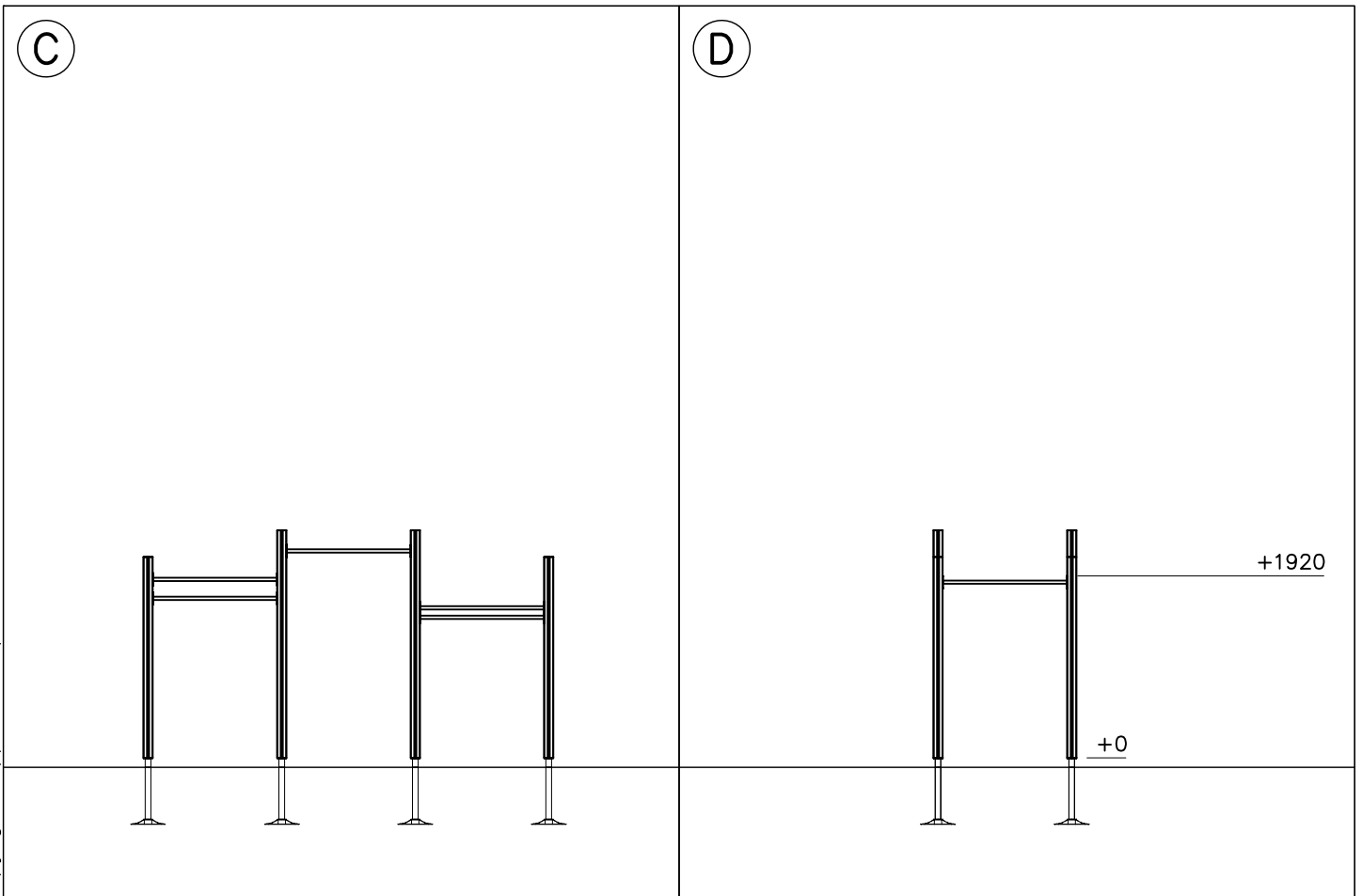
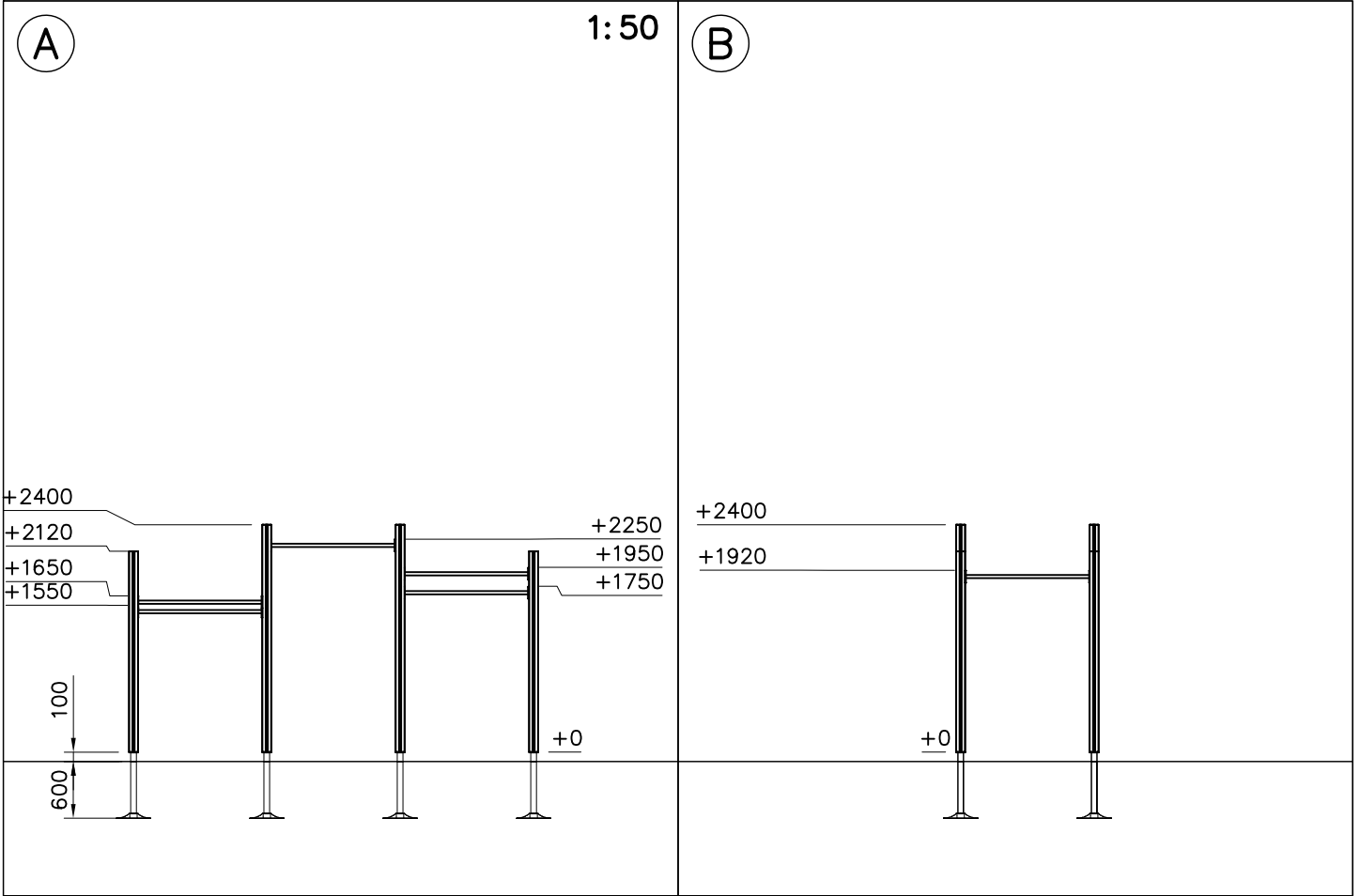

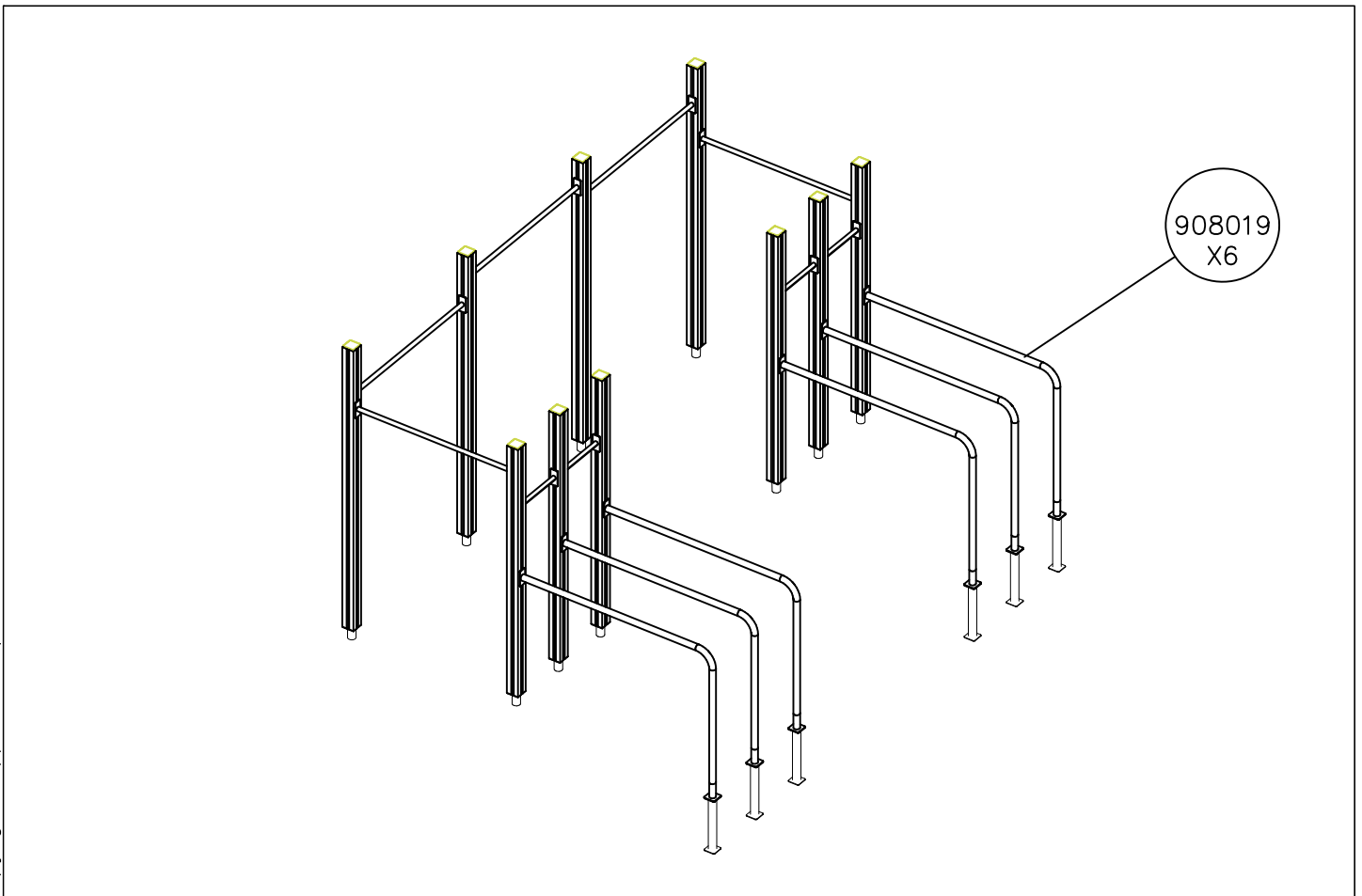
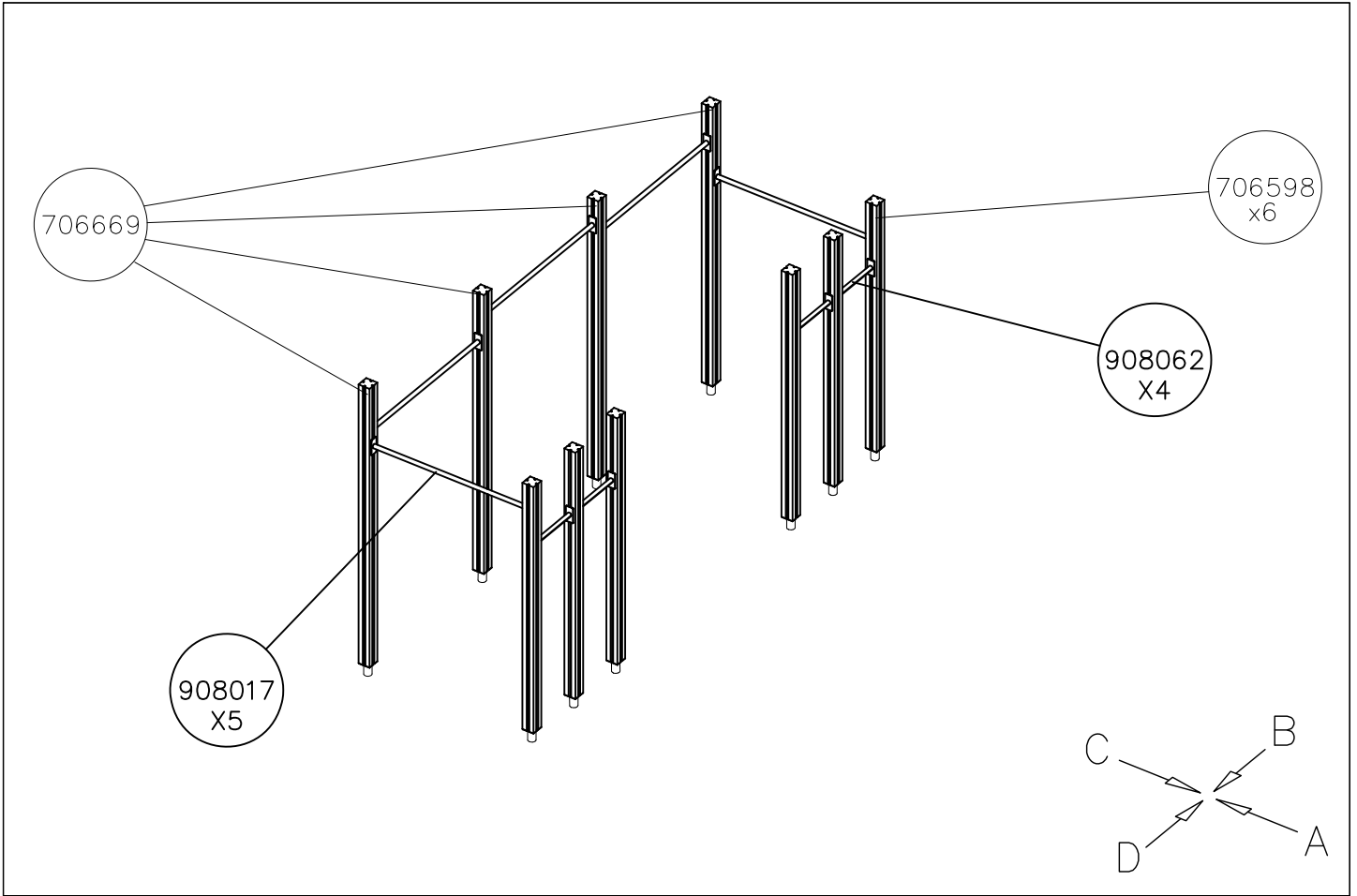

DATE: 9.1.2020

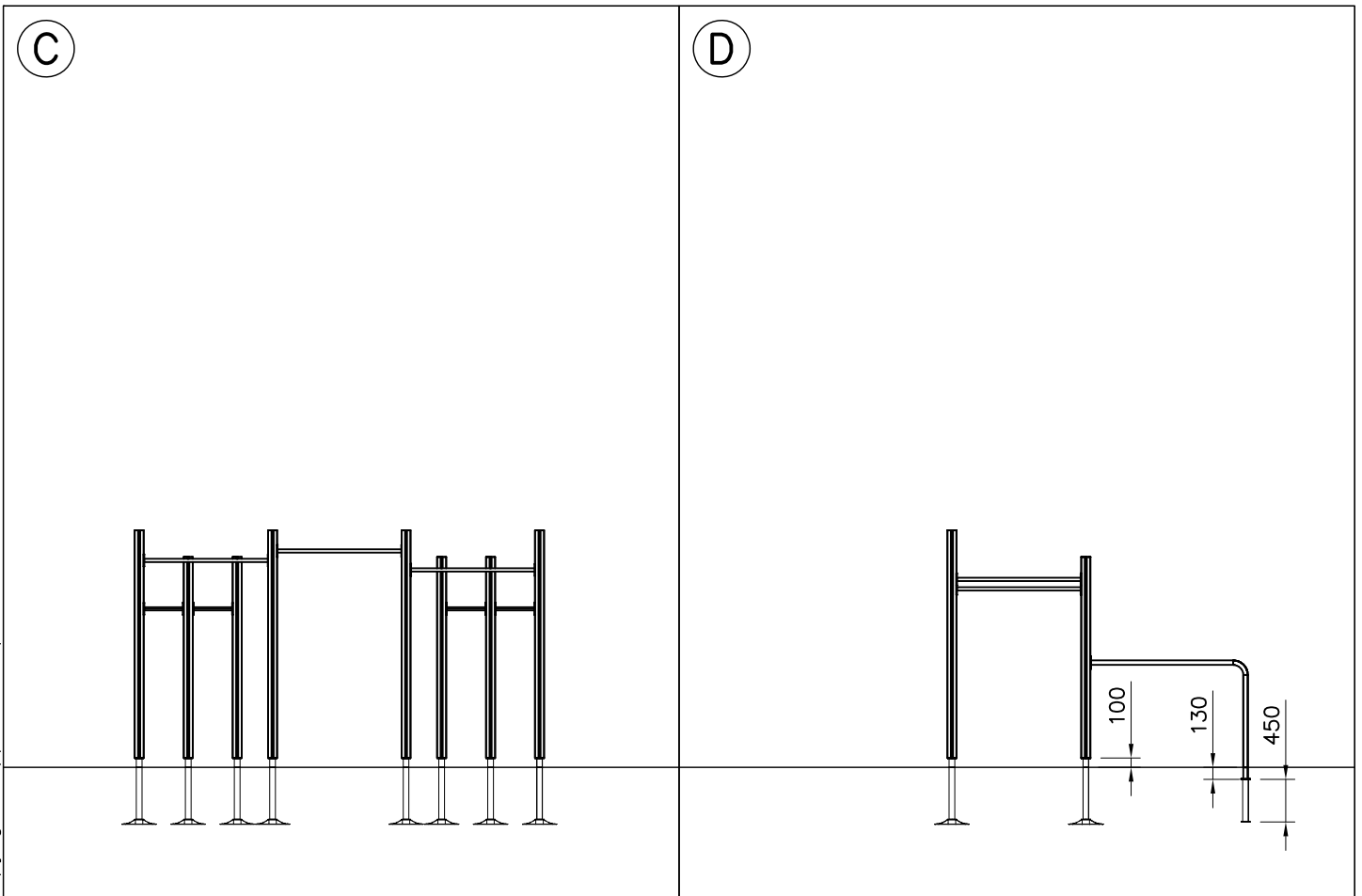
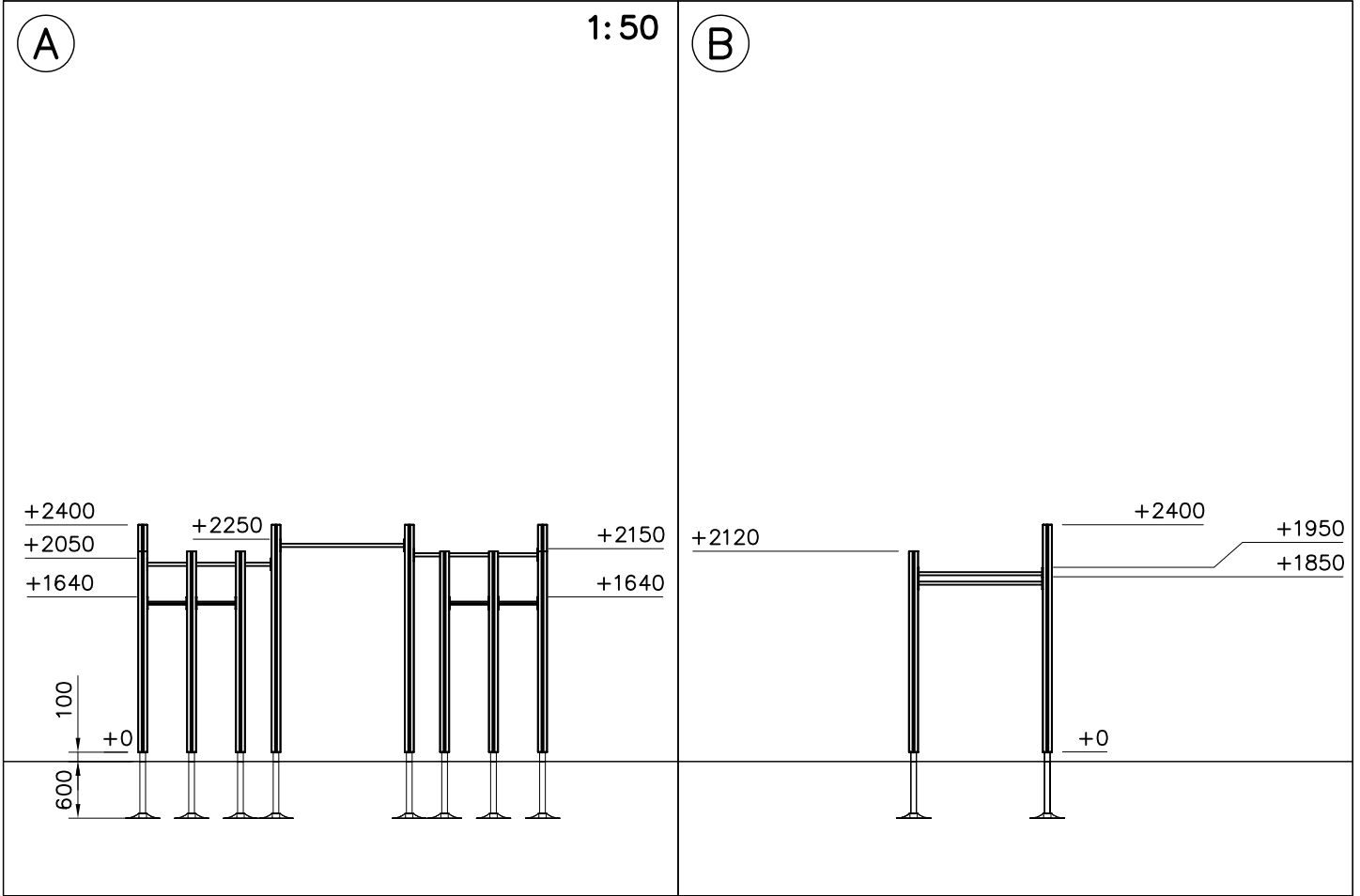

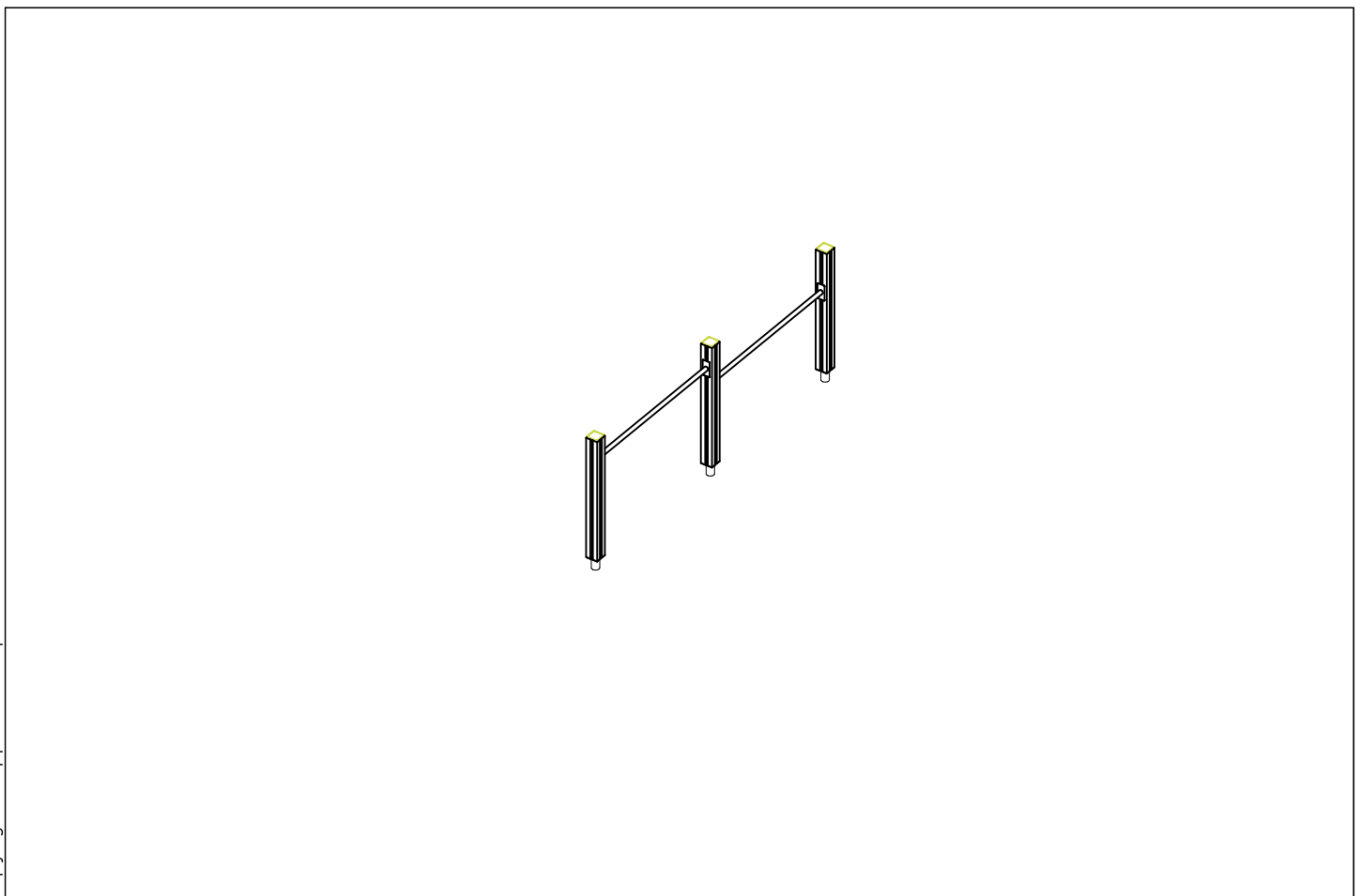
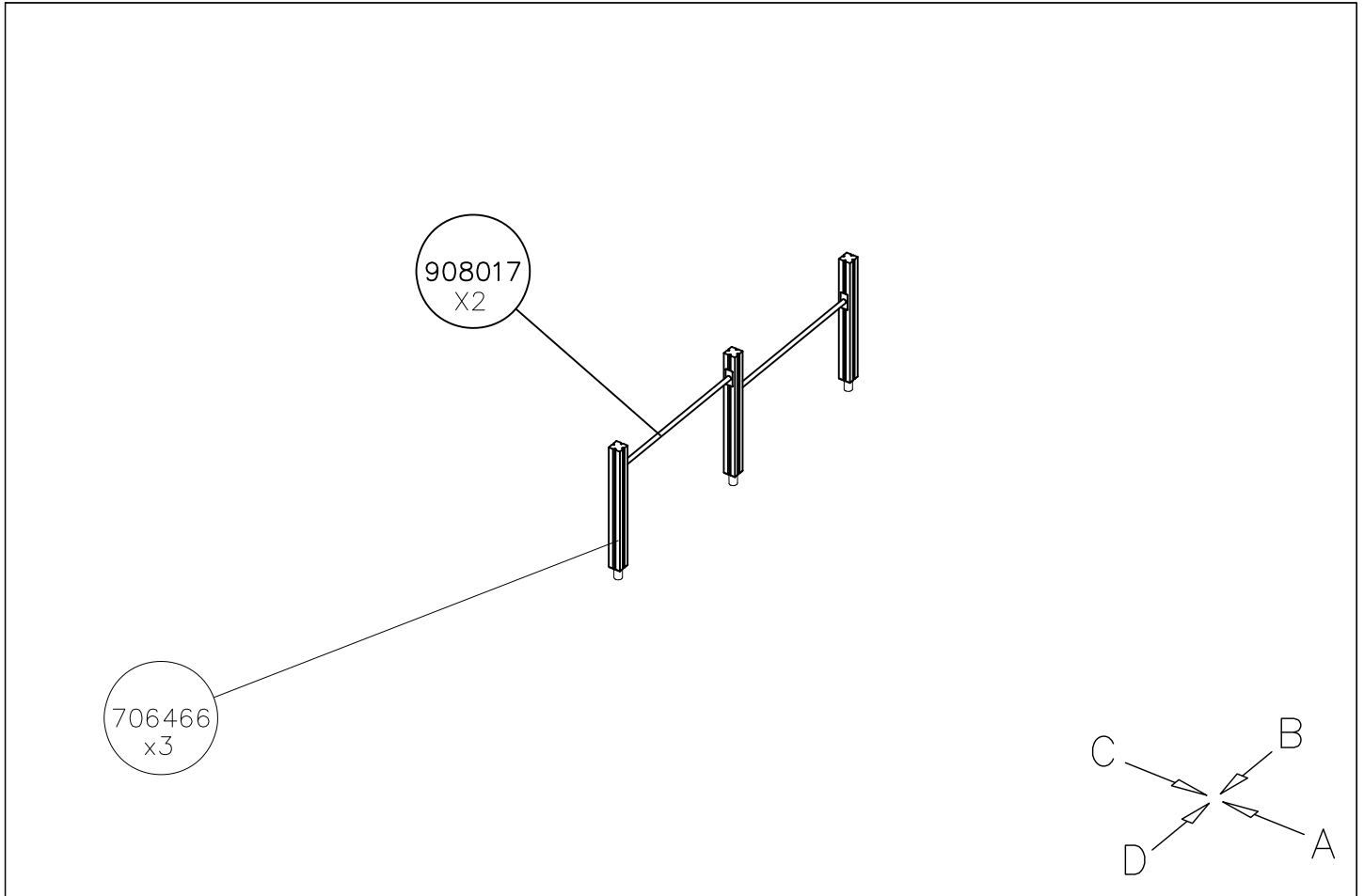

DATE: 9.1.2020

1:50

(A)

(B)

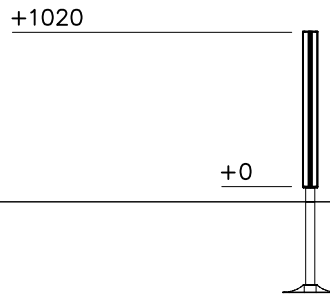
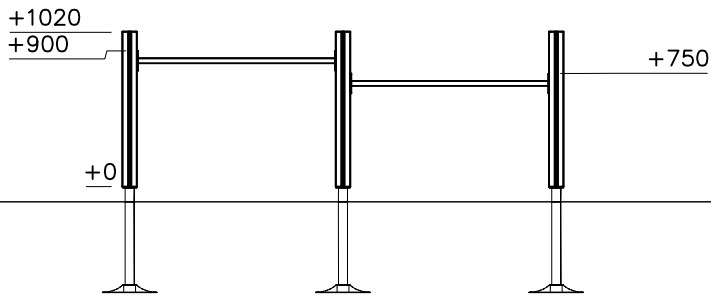

(C)

(D)

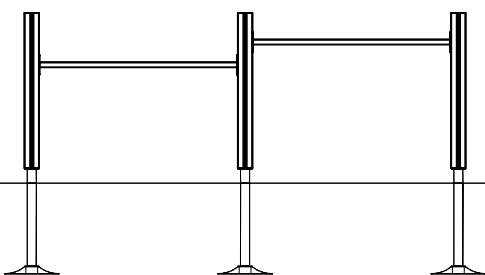

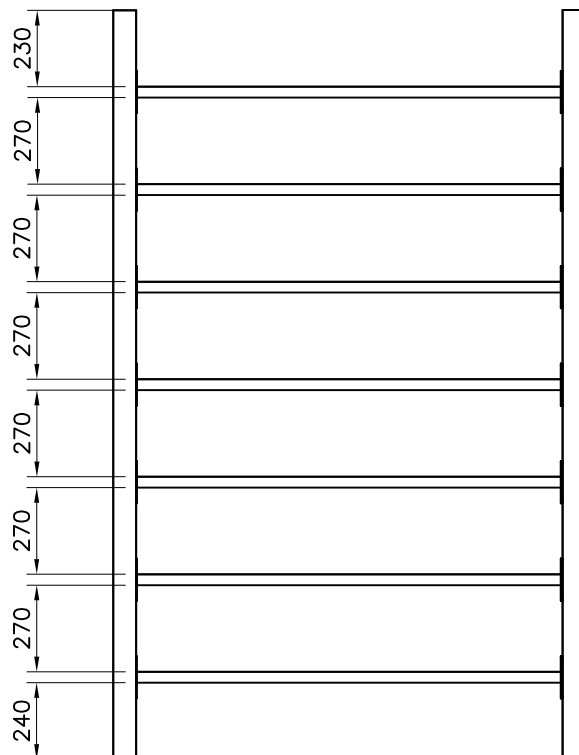
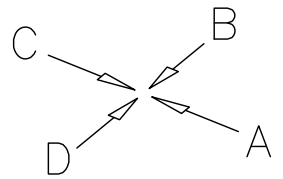
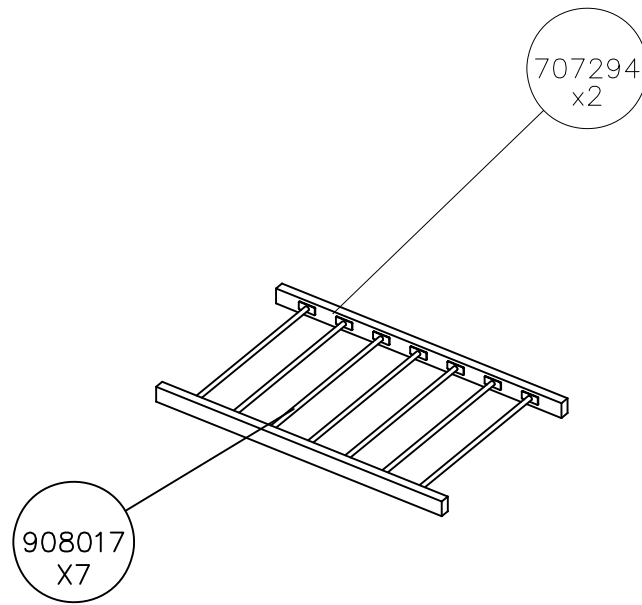

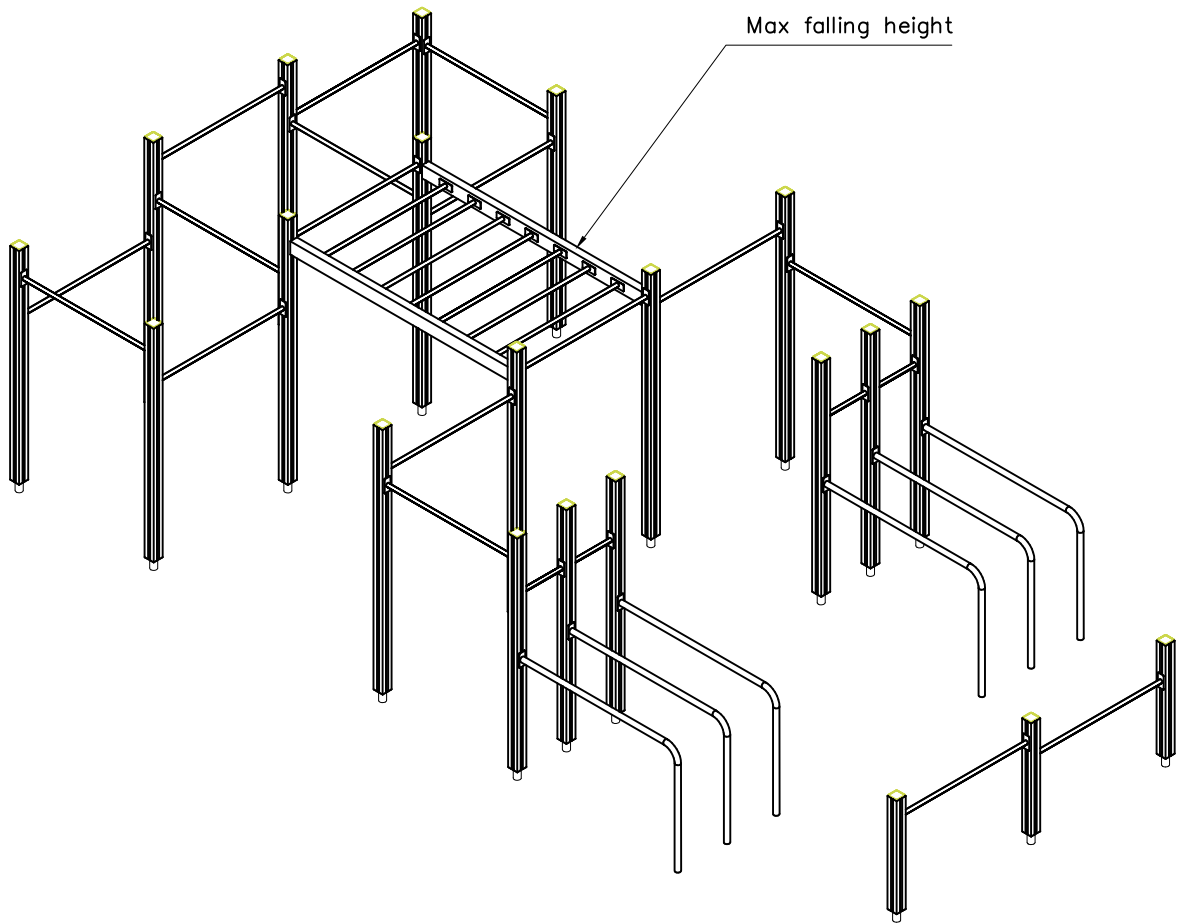

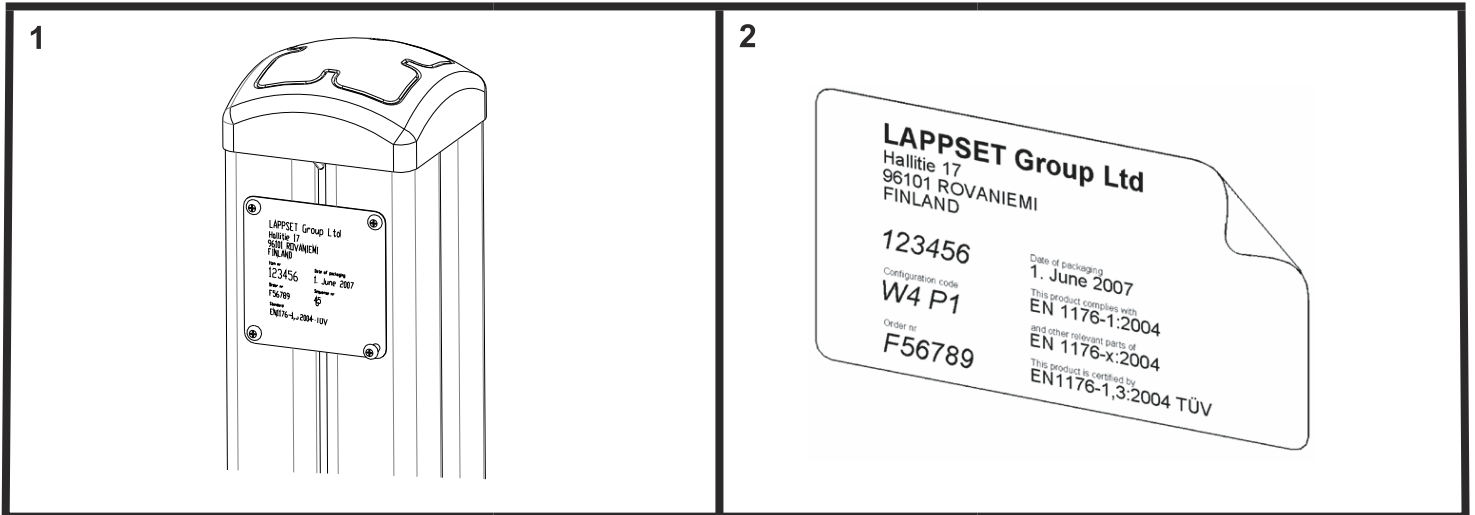

**Tuotekyltti tulee tuotteen mukana yhdellä seuraavista tavoista:**

**1) Metallinen tuotekyltti ja kiinnitysruuvit**

- Kiinnitä tuotekyltti ruuveilla tolppaan noin 2 metrin korkeuteen kuvan 1 mukaisesti.

**2) Tuotekylttitarra**

- Puhdista maalattu metalli- tai vaneripinta pölystä ja kosteudesta. Liimaa tarra kuvan 2 mukaisesti.
- Huom. Älä kiinnitä tarraa karheapintaiseen laminaattiin tai maalattuun puuhun.

**Vår produktmärkning levereras på ett av följande sätt:**

**1) Produktskylt i metall**

- Fäst skylten med de medföljande skruvarna

**2) Självhäftande produktetikett**

- Rengör den pulverlackerade metallytan eller laminatyten så att den blir fri från smuts och fukt. Fäst etiketten enligt fig. 2.
- Obs! Fäst ej etiketten på detaljer med skrovlig yta eller på målat trä.

**Product label is delivered by one of following ways:**

**1) Metal product label and screws**

- Fasten the label with screws.

**2) Label sticker**

- Clean the painted metal or plywood surface from dirt and moisture. Fasten the sticker as shown in the figure 2.
- Note. Do not attach the sticker to rough surfaced laminate or painted wood.

**La plaque d'informations produit est livrée sous l'une de ces 3 formes :**

**1) Plaque métallique et vis**

- Fixez la plaque à l'aide des vis.

**2) Etiquette autocollante**

- Avant de coller l'étiquette, nettoyez le composant métallique peint ou la plaque de contreplaqué, de toute saleté. La surface doit être sèche (voir image 2).
- Attention, ne pas coller l'étiquette sur une surface lamellé-collée irrégulière ou sur du bois peint.

**Die Auslieferung des Produktaufklebers erfolgt auf eine dieser Arten:**

**1) Produkt-Schild aus Metall incl. Schrauben**

- Die Befestigung des Schildes erfolgt mittels der Schrauben.

**2) Aufkleber**

- Entfernen Sie zunächst Schmutz und Feuchtigkeit vom lackierten Metall bzw. von der Holzoberfläche und bringen Sie den Aufkleber wie im Bild oben rechts beschrieben auf den gesäuberten Untergrund auf.
- Beachten Sie: Bringen Sie den Aufkleber nicht auf raues laminiertes oder lackiertes Holz an.



**LAPPSET®**  
**DEEP FOUNDATION**

**FOOT**

DATE: 13.3.2014

**4A**

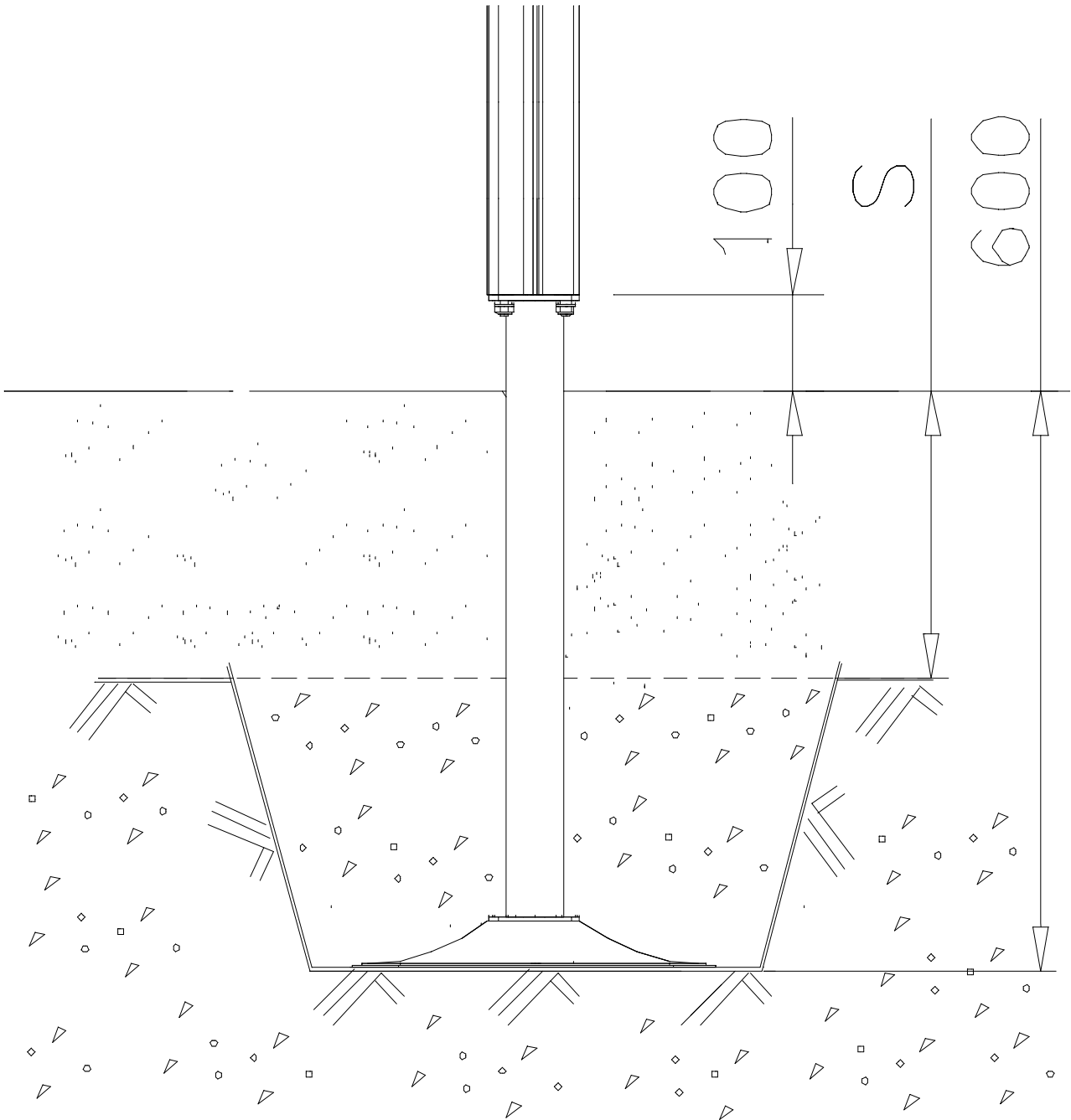
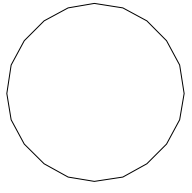

**LAPPSET®**  
**BETON FOUNDATION**

**FOOT**

DATE: 27.10.2015

**1(1)**

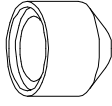
② 905104	PCS		PCS
	4		
 M10	PCS		PCS

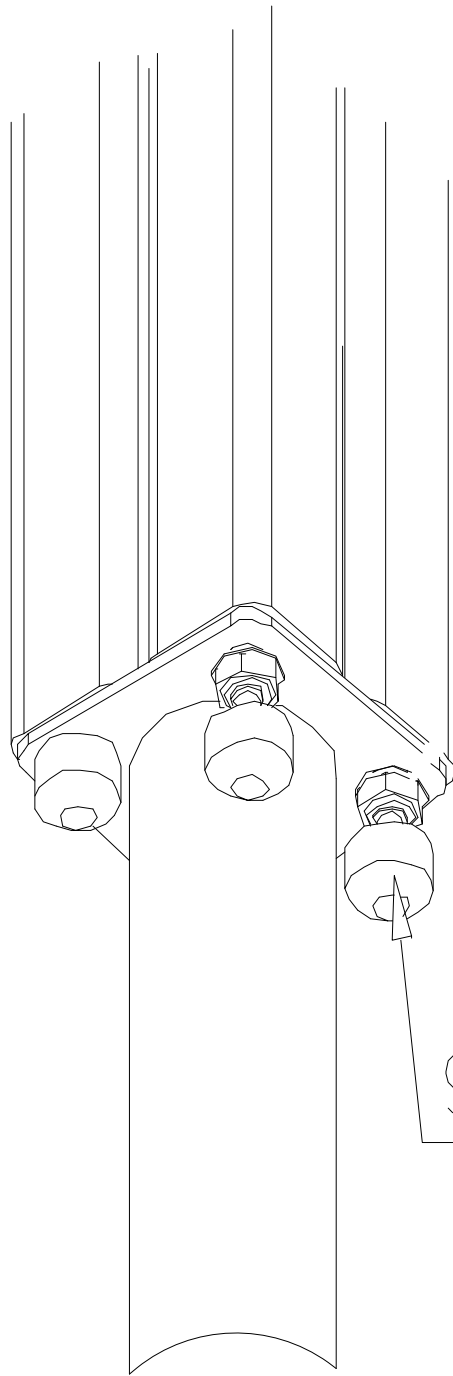

905104

# LAPPSET® DEEP FOUNDATION

# FOOT

DATE: 15.5.2018

1(1)

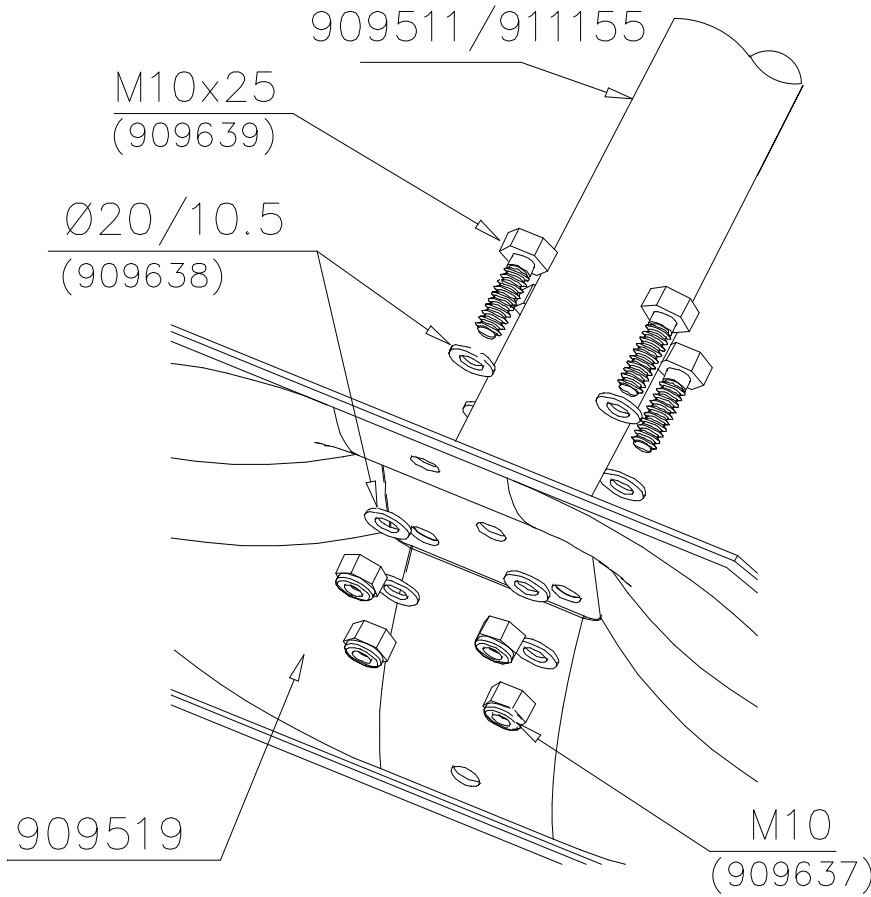

①	909511	PCS	②	909519	PCS
		1			1
	90x90x650			50x380x380	

③	909637	PCS	④	909638	PCS
		4			8
	M10			Ø20/10.5	

⑤	909639	PCS	⑥	905104	PCS
		4			4
	M10x25			M10	

OPTION FOOT

①	911155	PCS			PCS
		1			
	90x90x650				