

LAPPSET®

FINNO







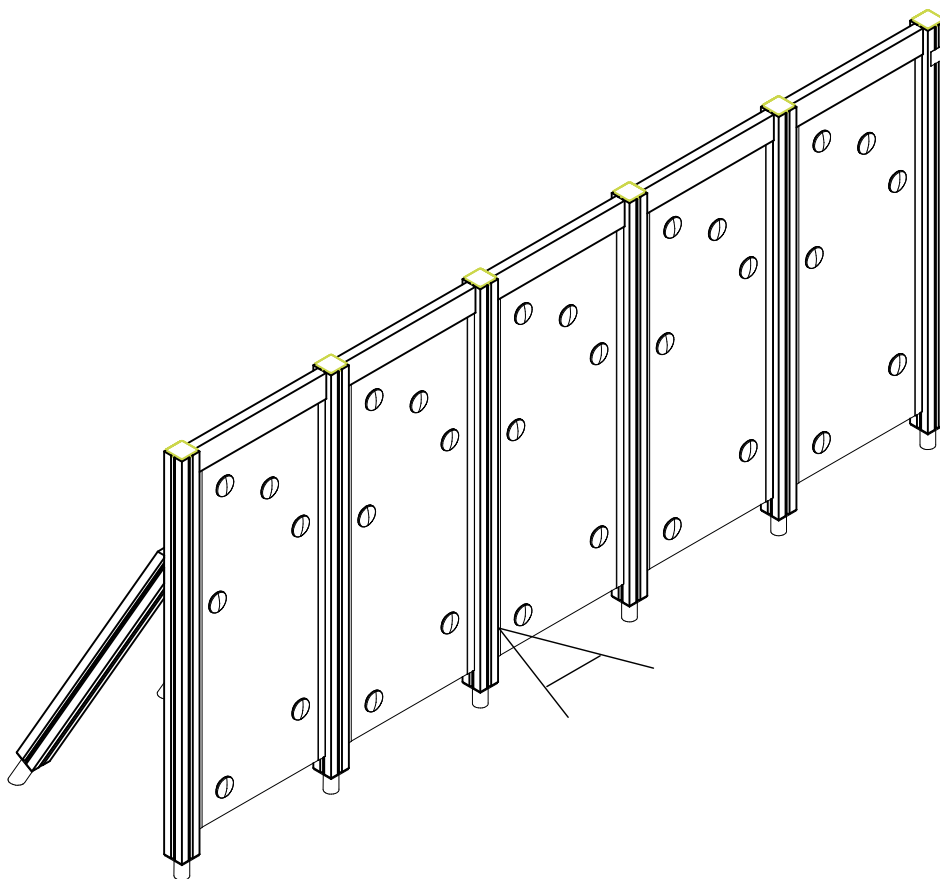

ASENNUSOHJE
MONTERINGSANSVISNING
INSTALLATION INSTRUCTION
AUFBAUANLEITUNG
NOTICE D'INSTALLATION

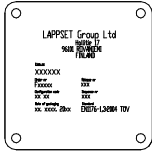
DATE: 27.11.2019

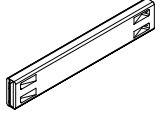
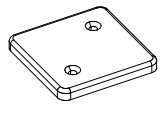
Q14323

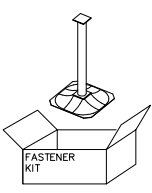
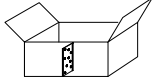
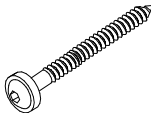
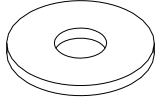
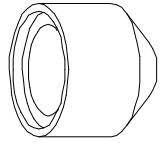

DATE: 27.11.2019

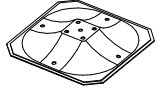
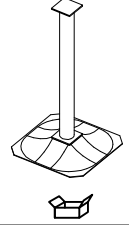
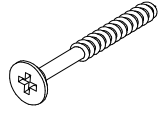
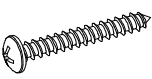
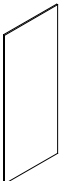
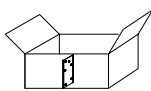
702286  65x65	PCS 1	703325-602  L 1530	PCS 6	706439-602  L 704	PCS 5	706481-703  83x83x10	PCS 6	706511-602  93x93x1870	PCS 6	706531  FASTENER KIT	PCS 6
706609 	PCS 5	903093  Ø8x90	PCS 20	905051  Ø24/8.5	PCS 12	905104  M10	PCS 24	907770 	PCS 10	909231  8x130	PCS 6
909233  8x100	PCS 6	909511  90x90x650	PCS 6	909519  50x380x380	PCS 6	909521  909521	PCS 6	980107  Ø6x60	PCS 12	980114  Ø4x20	PCS 4
P10177 	PCS 5	P14221 	PCS 5		PCS		PCS		PCS		PCS
	PCS		PCS		PCS		PCS		PCS		PCS
	PCS		PCS		PCS		PCS		PCS		PCS
	PCS		PCS		PCS		PCS		PCS		PCS

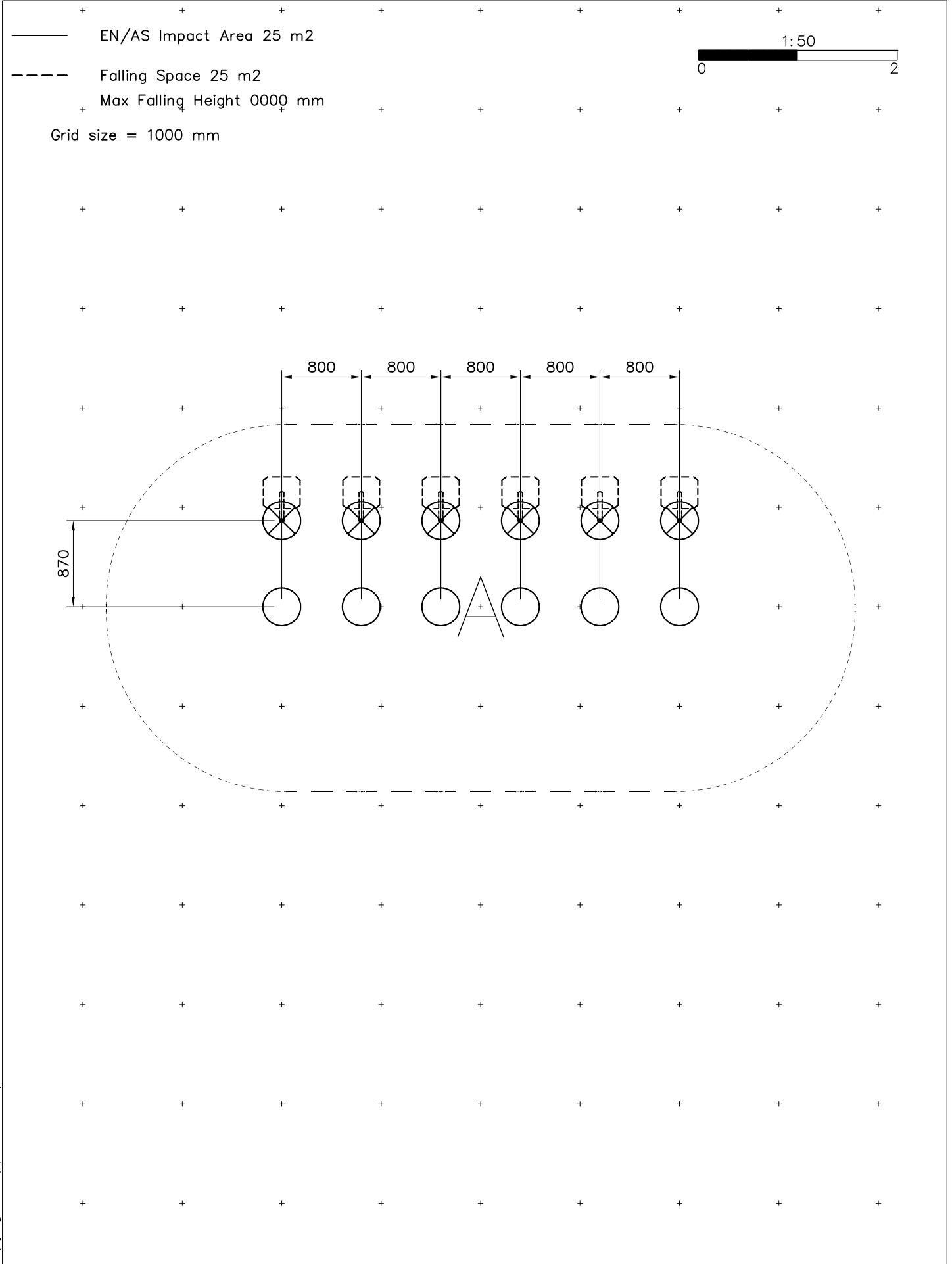

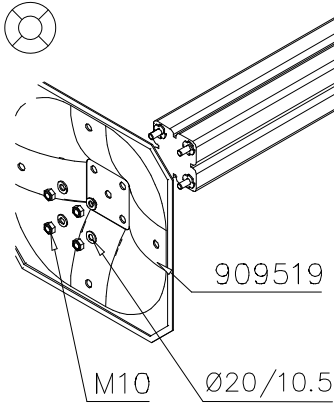
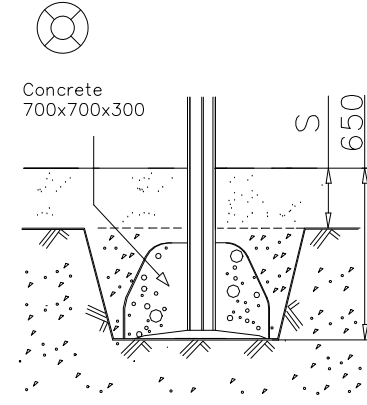

- EN/AS Impact Area 25 m²
- - - Falling Space 25 m²
Max Falling Height 1970 mm

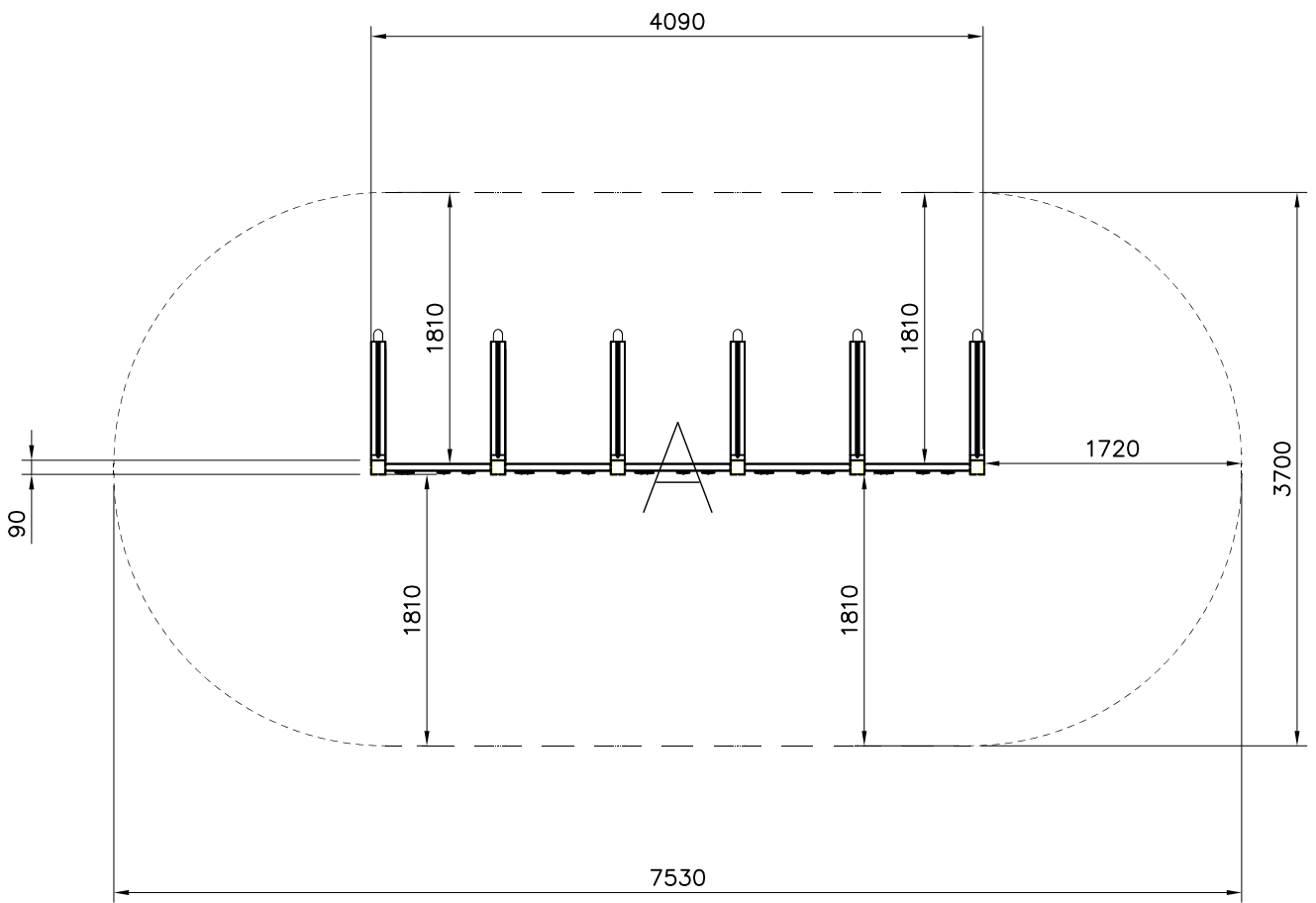
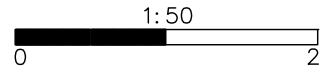

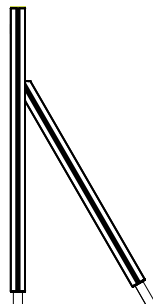
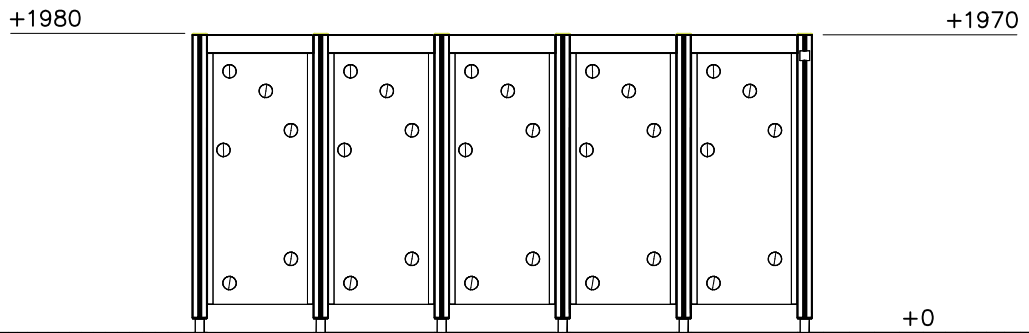

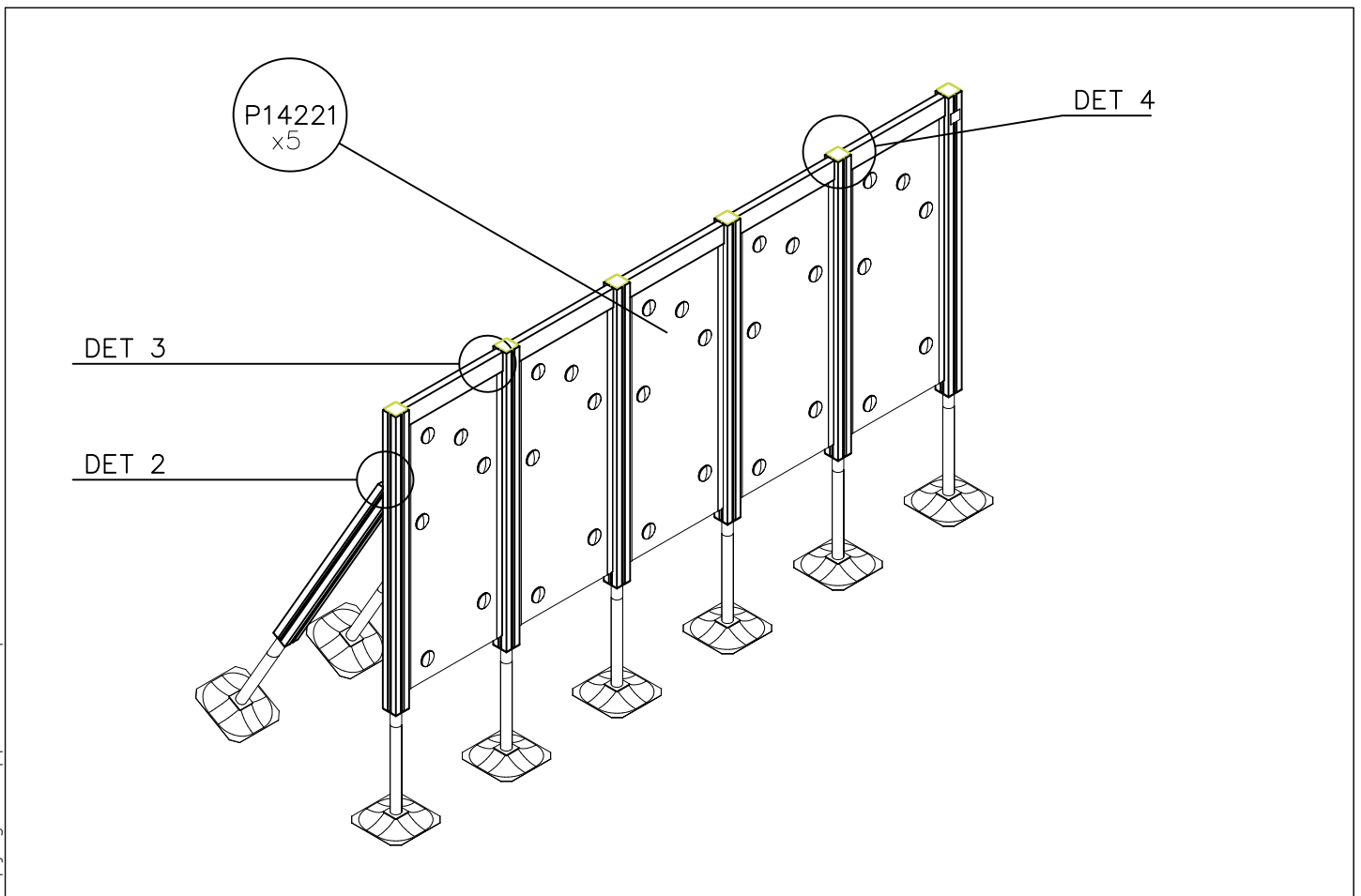
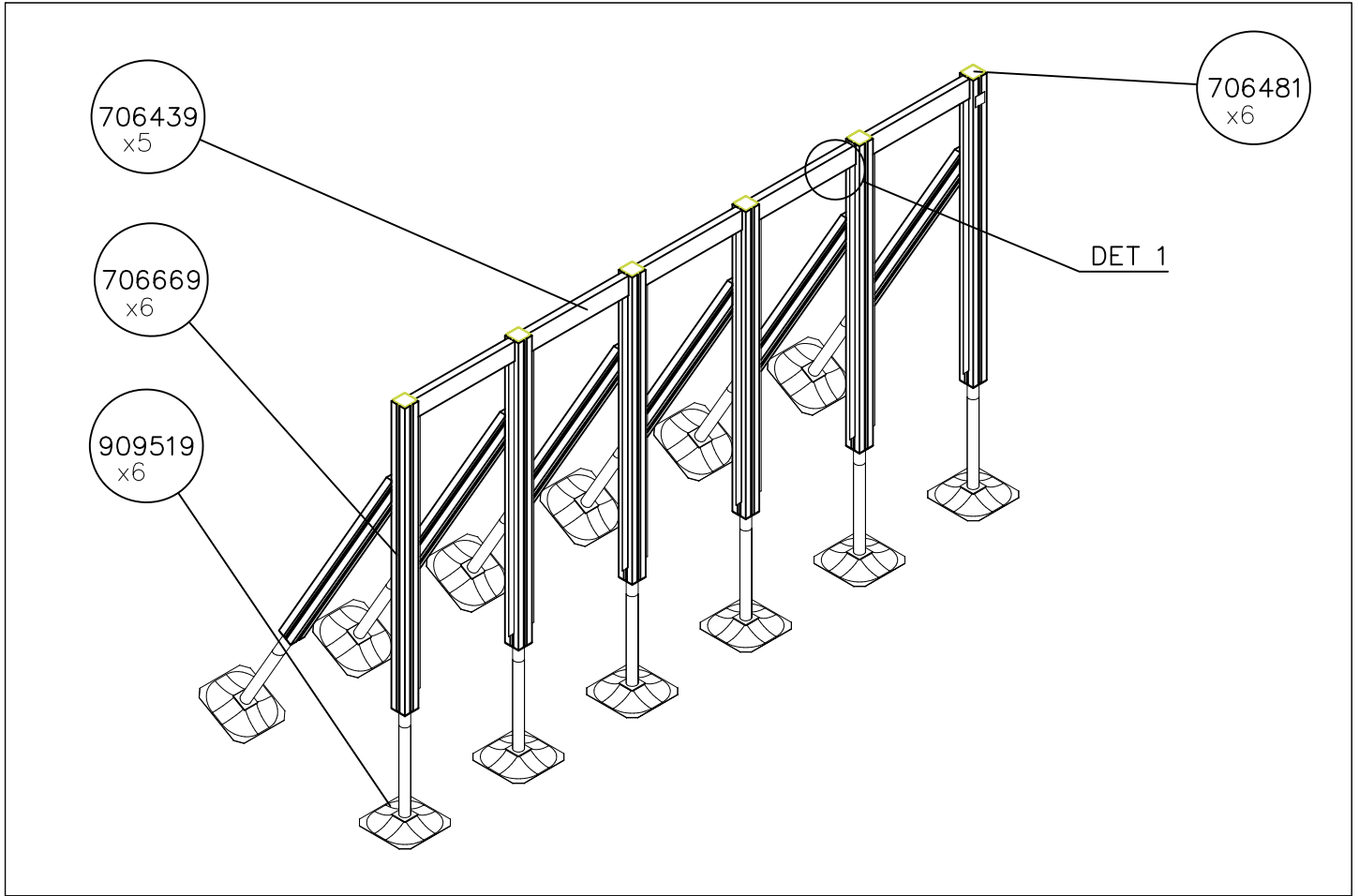

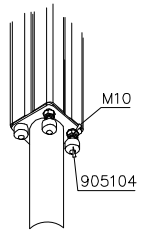
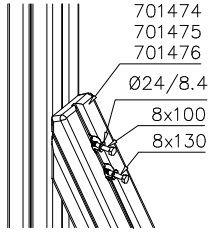
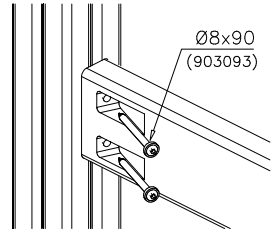
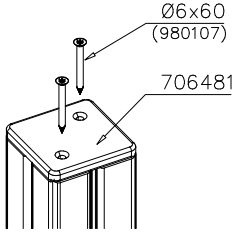

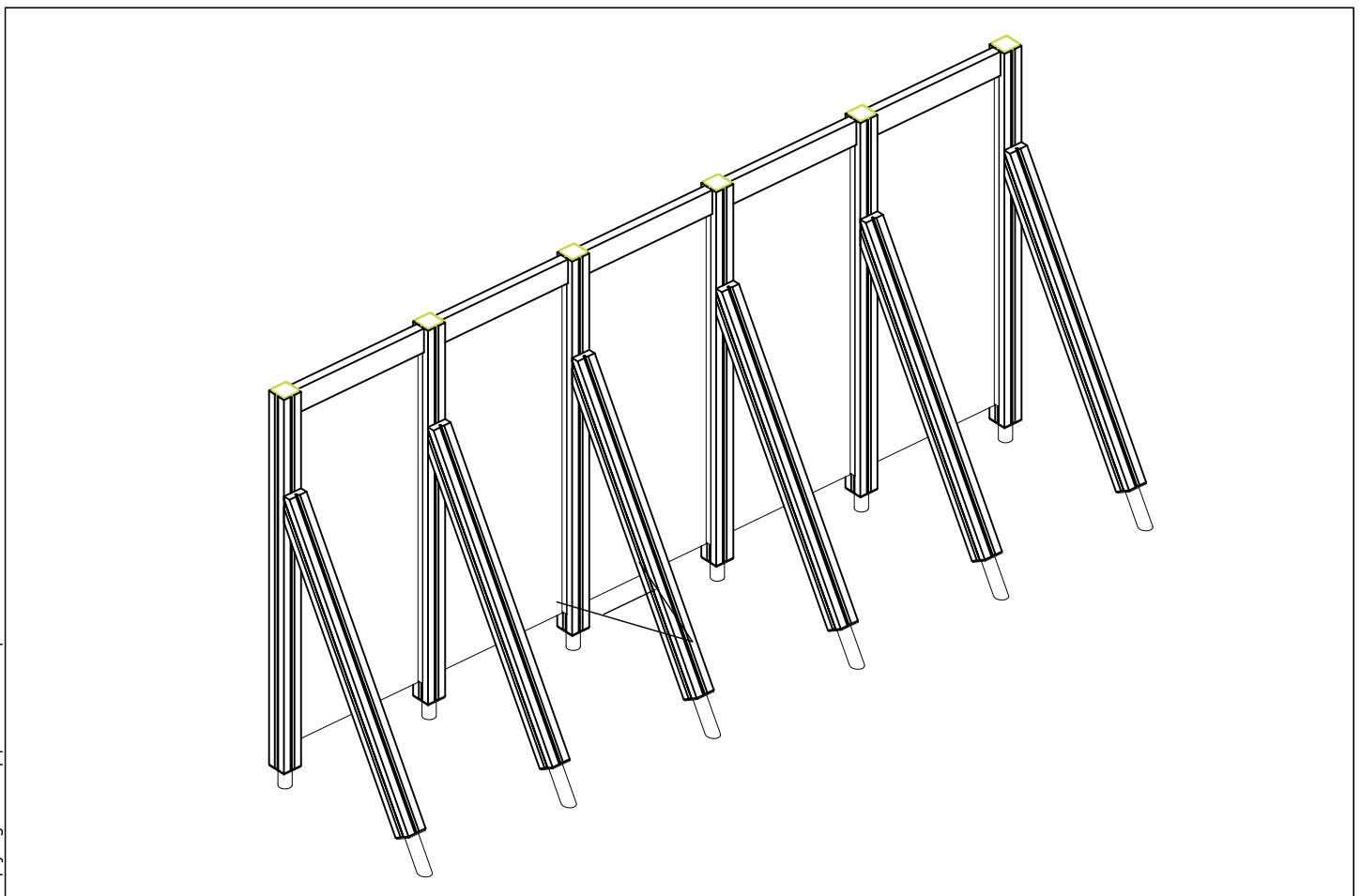
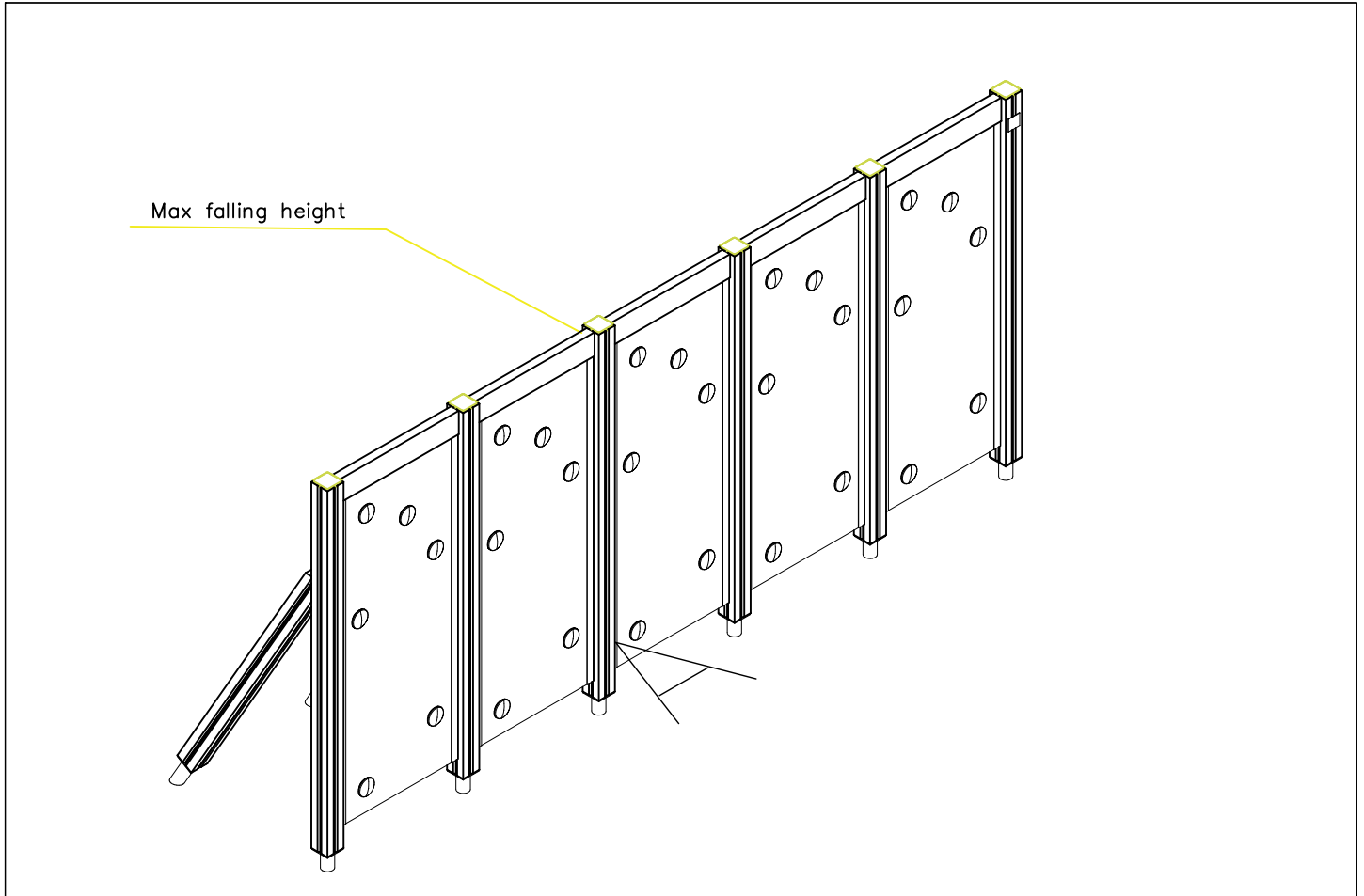

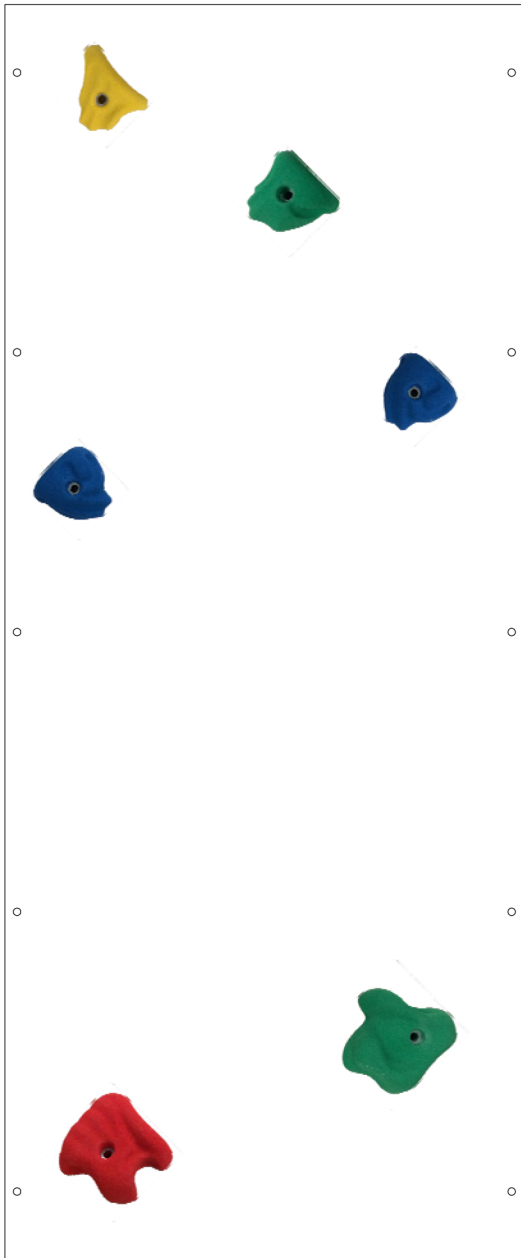







<p>DET 1</p> 	<p>DET 2</p> 	<p>DET 3</p> 	<p>DET 4</p> 





* 904301	PCS	* 904366	PCS
	1		1
XXL RED		XXL GREEN	
* 904298	PCS	* 904299	PCS
	2		1
L BLUE		L YELLOW	
* 904297	PCS	① 904336	PCS
	1		6
L GREEN		Ø6x20	
② 902232	PCS	③ 905090	PCS
	6		6
M10x55		Ø45	
④ 901302	PCS	⑤ 909637	PCS
	6		6
Ø20/10.5		M10	
⑥ 905115	PCS		PCS
	6		
Ø30			
	PCS		PCS
	PCS	○ P10177	PCS
			1
		12x686x1660	

HUOM!

Otepalan asennus, säätö tai paikan vaihto.

Säätömahdollisuus (90°,180°,270°).

Jos asennetun otepalan suunta- tai paikkaa halutaan muuttaa.

Irrota otepalan kiinnityspultti ja otepala, käännä tai vaihda.

Siirrä tarvittaessa tappi oikeaan upotusreikään. Asenna avatut osat paikoilleen ja lopuksi kiinnitä muovitulppa Ø30 paikoilleen kaikkiin otekokoonpanoihin.

NOTE:

Grip positions and angles are adjustable (90°,180°270°).

Grip can be repositioned by removing the fastening bolt and pulling the grip off.

Securing pin can be repositioned when angle is changed.

After the parts are reassembled. Finish the assembly by fastening the cover plugs (Ø30).

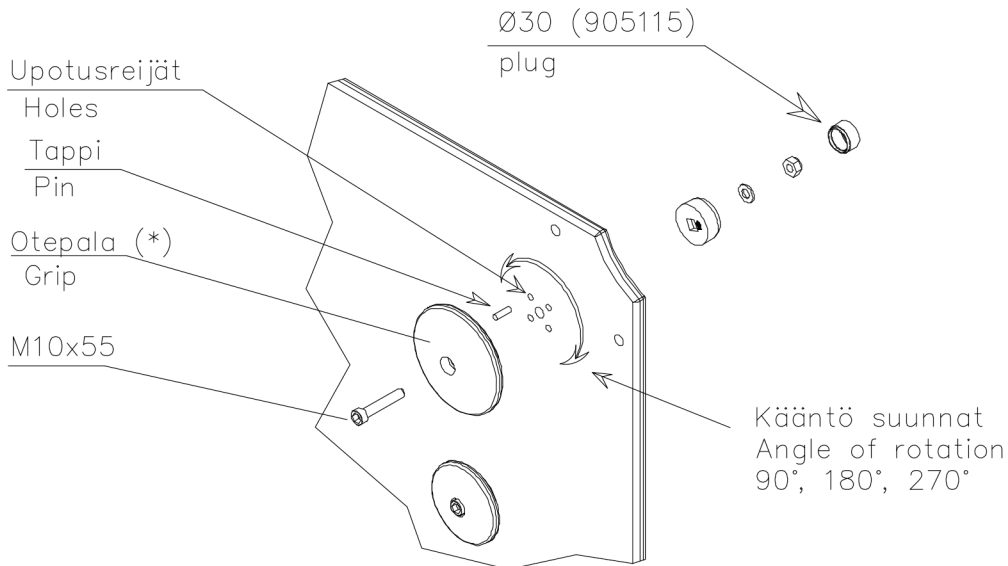

LAPPSET®
BETON FOUNDATION

FOOT

DATE: 27.10.2015





1(1)

② 905104	PCS		PCS
	4		
 M10	PCS		PCS

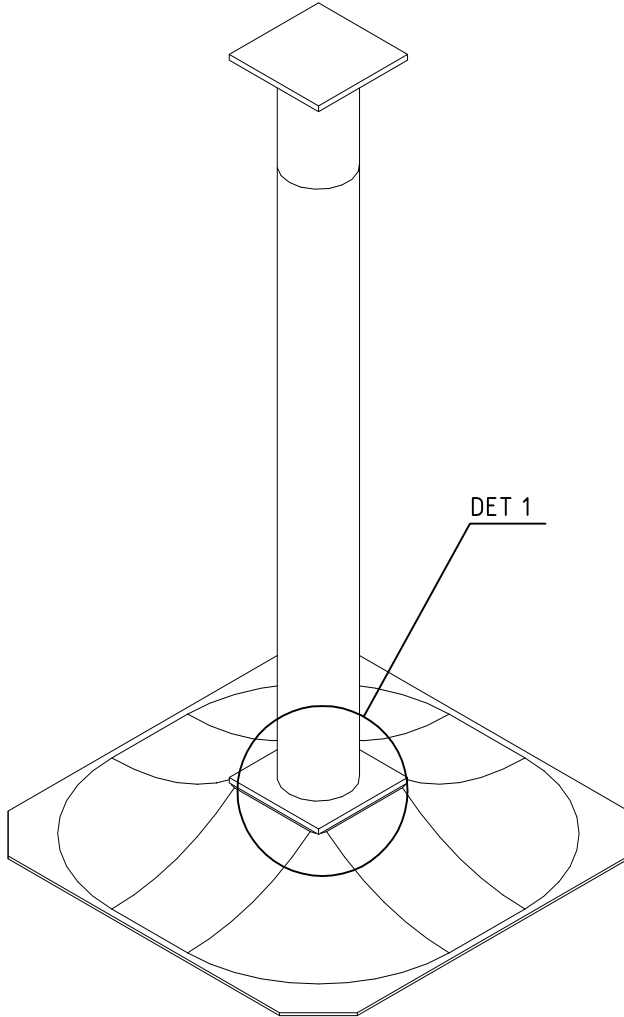

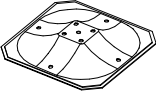
905104



①	909511	PCS	②	909519	PCS
		1			1
③	909637	PCS	④	909638	PCS
		4			8
	M10			Ø20/10.5	
⑤	909639	PCS			PCS
		4			
	M10x25				
		PCS			PCS
		PCS			PCS
		PCS			PCS
		PCS			PCS
		PCS			PCS



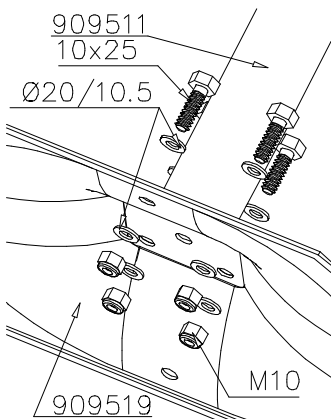





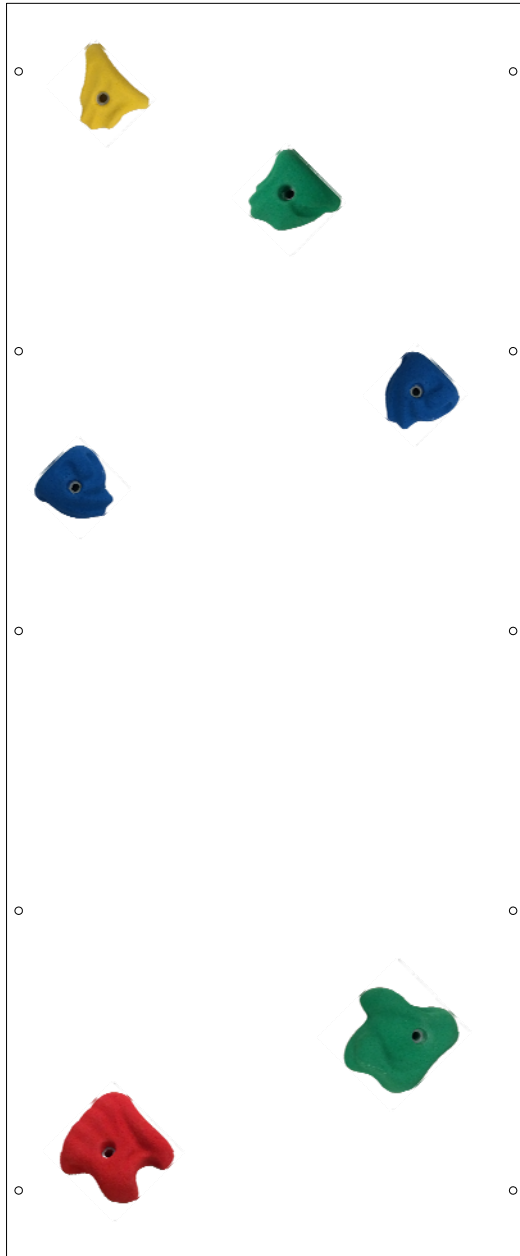



DET 1









* 904301	PCS	* 904366	PCS
	1		1
XXL RED		XXL GREEN	
* 904298	PCS	* 904299	PCS
	2		1
L BLUE		L YELLOW	
* 904297	PCS	① 904336	PCS
	1		6
L GREEN		Ø6x20	
② 902232	PCS	③ 905090	PCS
	6		6
M10x55		Ø45	
④ 901302	PCS	⑤ 909637	PCS
	6		6
Ø20/10.5		M10	
⑥ 905115	PCS		PCS
	6		
Ø30			
	PCS		PCS
	PCS	○ P10177	PCS
			1
		12x686x1660	

HUOM!

Otepalan asennus, säätö tai paikan vaihto.
Säätömahdollisuus (90°,180°,270°).

Jos asennetun otepalan suuntaa- tai paikkaa halutaan muuttaa. Irrota otepalan kiinnityspultti ja otepala, käännä tai vaihda. Siirrä tarvittaessa tappi oikeaan upotusreikään. Asenna avatut osat paikoilleen ja lopuksi kiinnitä muovitulppa Ø30 paikoilleen kaikkiin otekokoonpanoihin.

NOTE:

Grip positions and angles are adjustable (90°,180°270°).

Grip can be repositioned by removing the fastening bolt and pulling the grip off.
Securing pin can be repositioned when angle is changed.
After the parts are reassembled. Finish the assembly by fastening the cover plugs (Ø30).

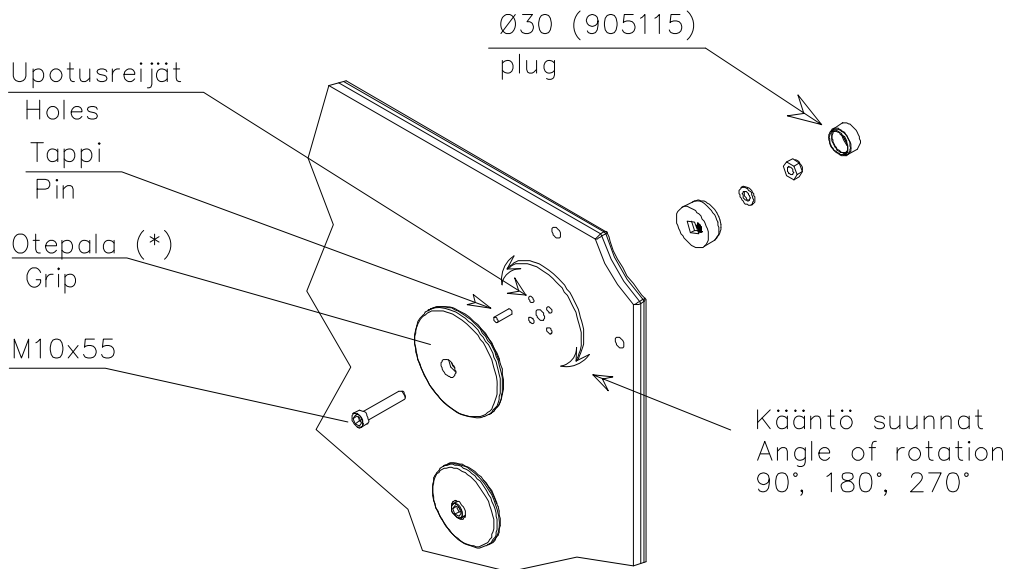



Tuotekyltti tulee tuotteen mukana yhdellä seuraavista tavoista:

1) Metallinen tuotekyltti ja kiinnitysruuvit

- Kiinnitä tuotekyltti ruuveilla tolppaan noin 2 metrin korkeuteen kuvan 1 mukaisesti.

2) Tuotekylttitarra

- Puhdista maalattu metalli- tai vaneripinta pölystä ja kosteudesta. Liimaa tarra kuvan 2 mukaisesti.
- Huom. Älä kiinnitä tarraa karheapintaiseen laminaattiin tai maalattuun puuhun.

Vår produktmärkning levereras på ett av följande sätt:

1) Produktskylt i metall

- Fäst skylten med de medföljande skruvarna

2) Självhäftande produktetikett

- Rengör den pulverlackerade metallytan eller laminatyten så att den blir fri från smuts och fukt. Fäst etiketten enligt fig. 2.
- Obs! Fäst ej etiketten på detaljer med skrovlig yta eller på målat trä.

Product label is delivered by one of following ways:

1) Metal product label and screws

- Fasten the label with screws.

2) Label sticker

- Clean the painted metal or plywood surface from dirt and moisture. Fasten the sticker as shown in the figure 2.
- Note. Do not attach the sticker to rough surfaced laminate or painted wood.

La plaque d'informations produit est livrée sous l'une de ces 3 formes :

1) Plaque métallique et vis

- Fixez la plaque à l'aide des vis.

2) Etiquette autocollante

- Avant de coller l'étiquette, nettoyez le composant métallique peint ou la plaque de contreplaqué, de toute saleté. La surface doit être sèche (voir image 2).
- Attention, ne pas coller l'étiquette sur une surface lamellé-collée irrégulière ou sur du bois peint.

Die Auslieferung des Produktaufklebers erfolgt auf eine dieser Arten:

1) Produkt-Schild aus Metall incl. Schrauben

- Die Befestigung des Schildes erfolgt mittels der Schrauben.

2) Aufkleber

- Entfernen Sie zunächst Schmutz und Feuchtigkeit vom lackierten Metall bzw. von der Holzoberfläche und bringen Sie den Aufkleber wie im Bild oben rechts beschrieben auf den gesäuberten Untergrund auf.
- Beachten Sie: Bringen Sie den Aufkleber nicht auf raues laminiertes oder lackiertes Holz an.

LAPPSET® DEEP FOUNDATION

FOOT



DATE: 15.5.2018

1(1)

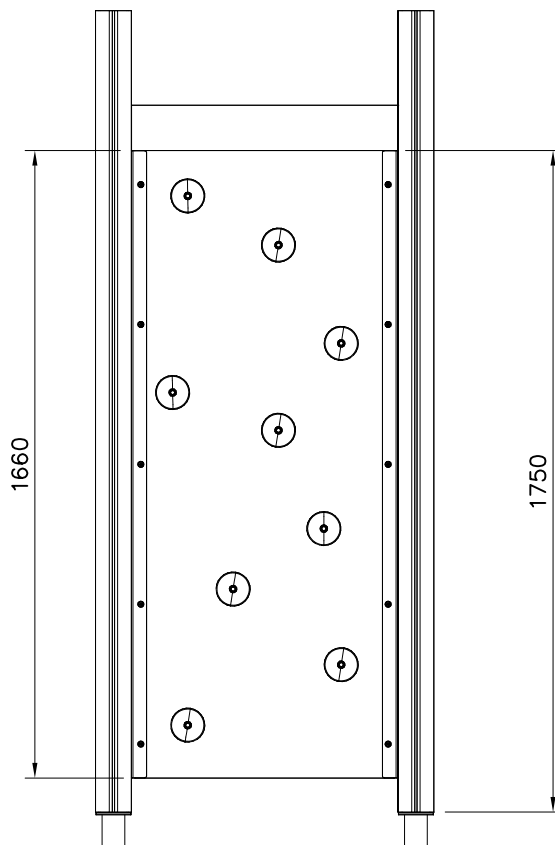
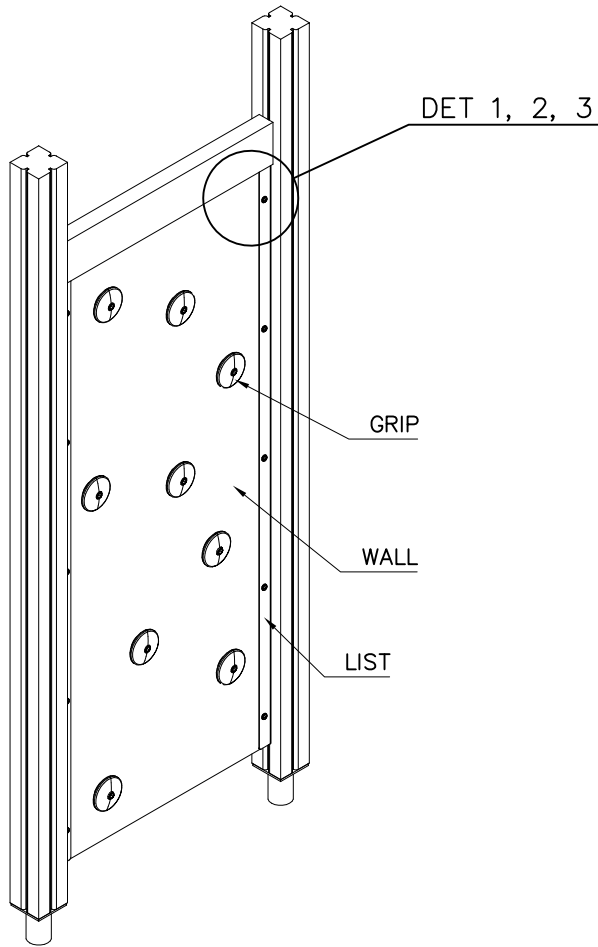

①	909511	PCS	②	909519	PCS
		1		1	
	90x90x650		50x380x380		
③	909637	PCS	④	909638	PCS
		4		8	
	M10		Ø20/10.5		
⑤	909639	PCS	⑥	905104	PCS
		4		4	
	M10x25		M10		
OPTION FOOT					
①	911155	PCS			PCS
		1			
	90x90x650				

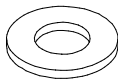
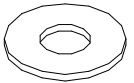
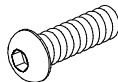
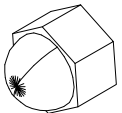
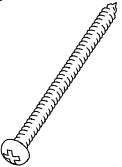

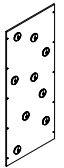
① 909256	PCS	② 980152	PCS
	10		10
Ø16/8.4x1.6		Ø24/8.4x2	
③ 909850	PCS	④ 909633	PCS
	10		10
M8x25		M8	
	PCS	⑤ 980131	PCS
			10
		Ø6x60	
	PCS		PCS
	PCS		PCS
	PCS		PCS
○ 907770	PCS	○ 706646 + grips	PCS
	2		1
2x35/40x1659			
	PCS		PCS

DET 1

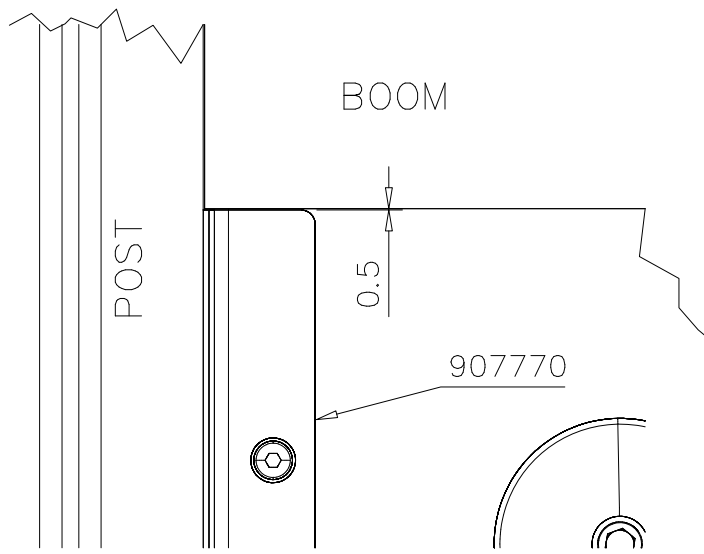

DET 2

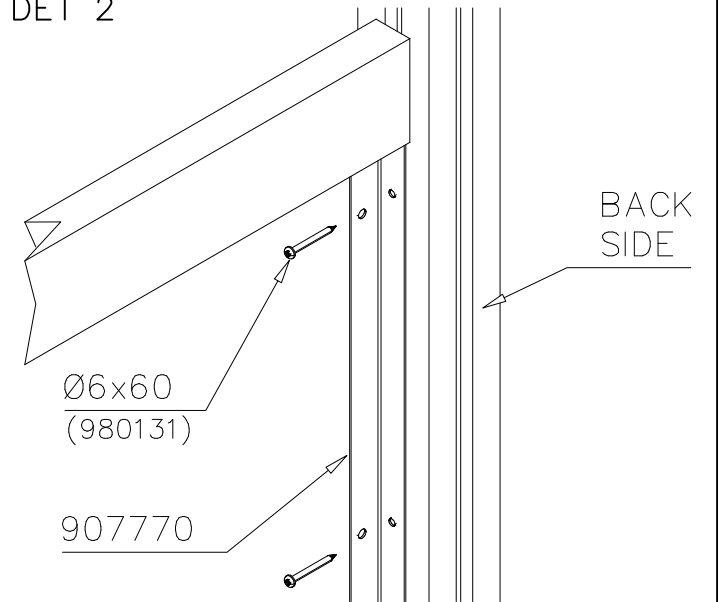

DET 3

