

LAPPSET®

FINNO



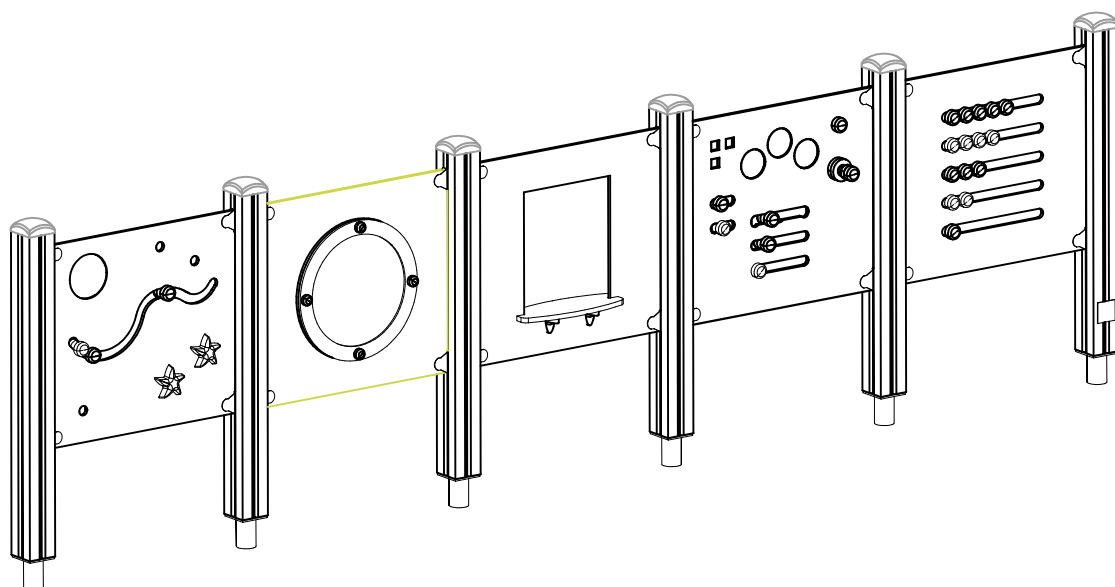

ASENNUSOHJE
MONTERINGSANSVISNING
INSTALLATION INSTRUCTION
AUFBAUANLEITUNG
NOTICE D'INSTALLATION

DATE: 26.11.2019

Q14311

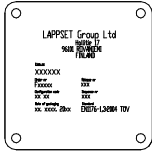
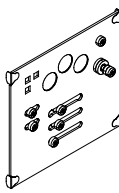
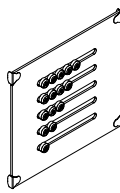

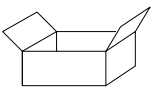
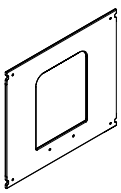
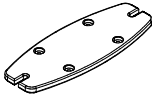
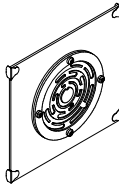
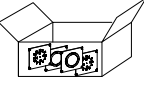
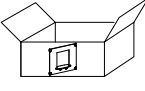
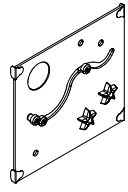
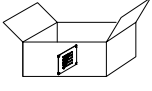
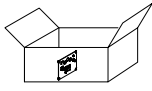
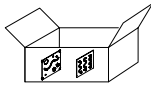
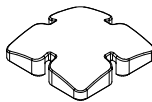
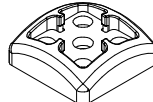
DATE: 26.11.2019

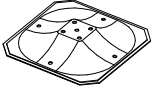
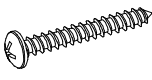
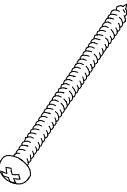
702286  65x65	PCS 1	705705-707  10x640x702	PCS 1	706308-703  10x640x702	PCS 1	706466-602  93x93x1025	PCS 6	706531 	PCS 6	706727-702  10x702x640	PCS 1
706744  15x145x380	PCS 1	706766-703  10x640x702	PCS 1	706778 	PCS 1	706885 	PCS 1	707209-701  10x640x702	PCS 1	707446 	PCS 1
707449 	PCS 1	707450 	PCS 1	905138  GRAY	PCS 6	905196  GRAY	PCS 6	909511  90x90x650	PCS 6	909519  50x380x380	PCS 6
980114  Ø4x20	PCS 4	980131  Ø6x60	PCS 24		PCS		PCS		PCS		PCS
	PCS		PCS		PCS		PCS		PCS		PCS
	PCS		PCS		PCS		PCS		PCS		PCS
	PCS		PCS		PCS		PCS		PCS		PCS

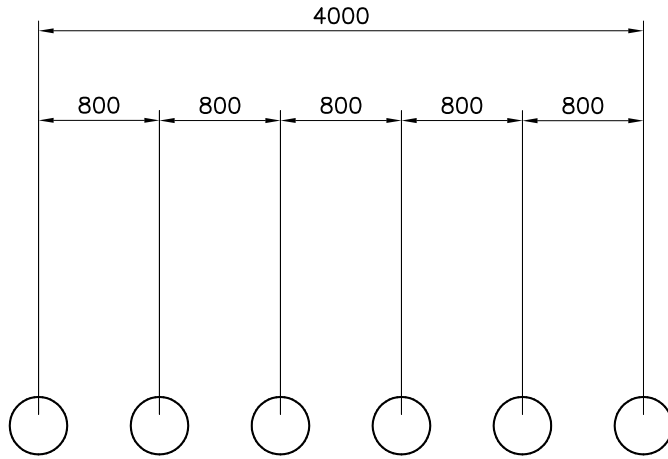
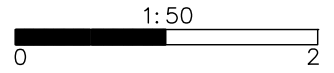

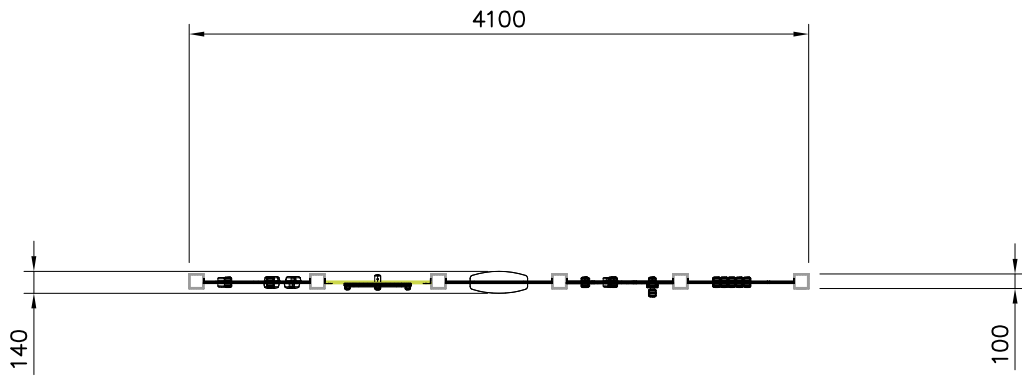
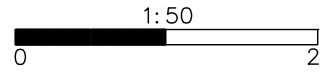

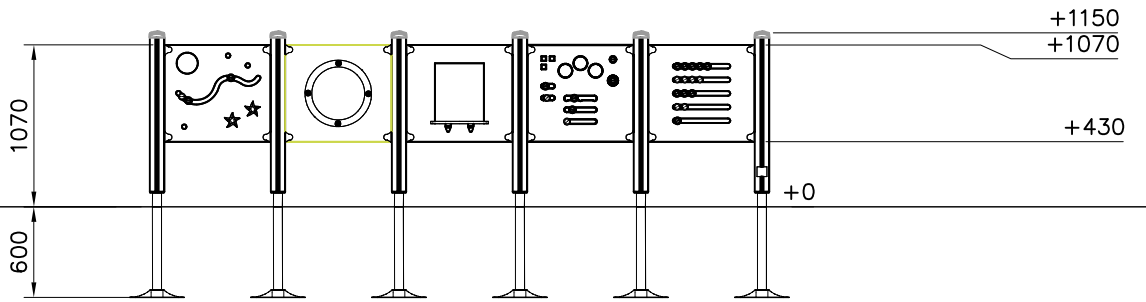

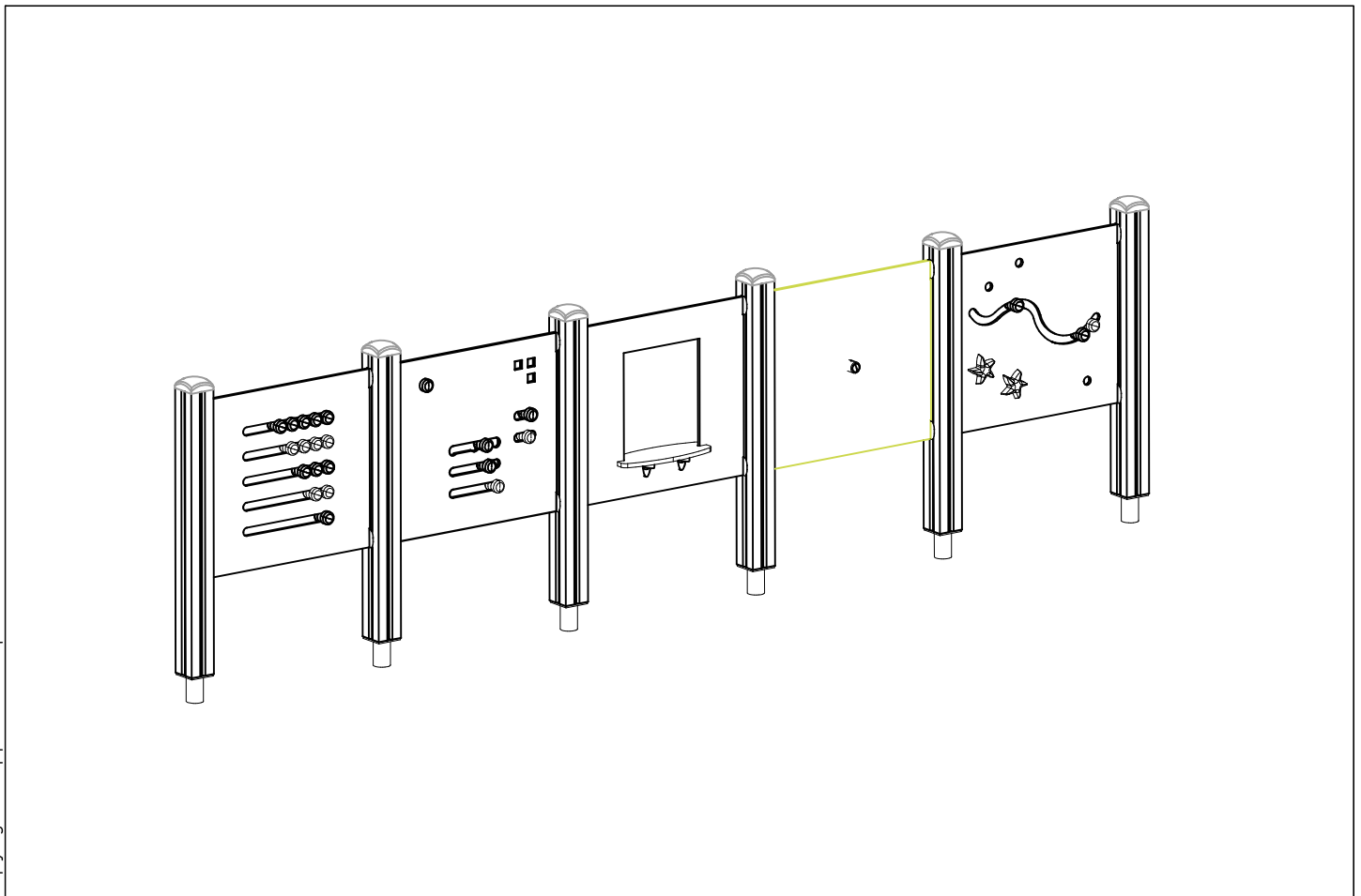
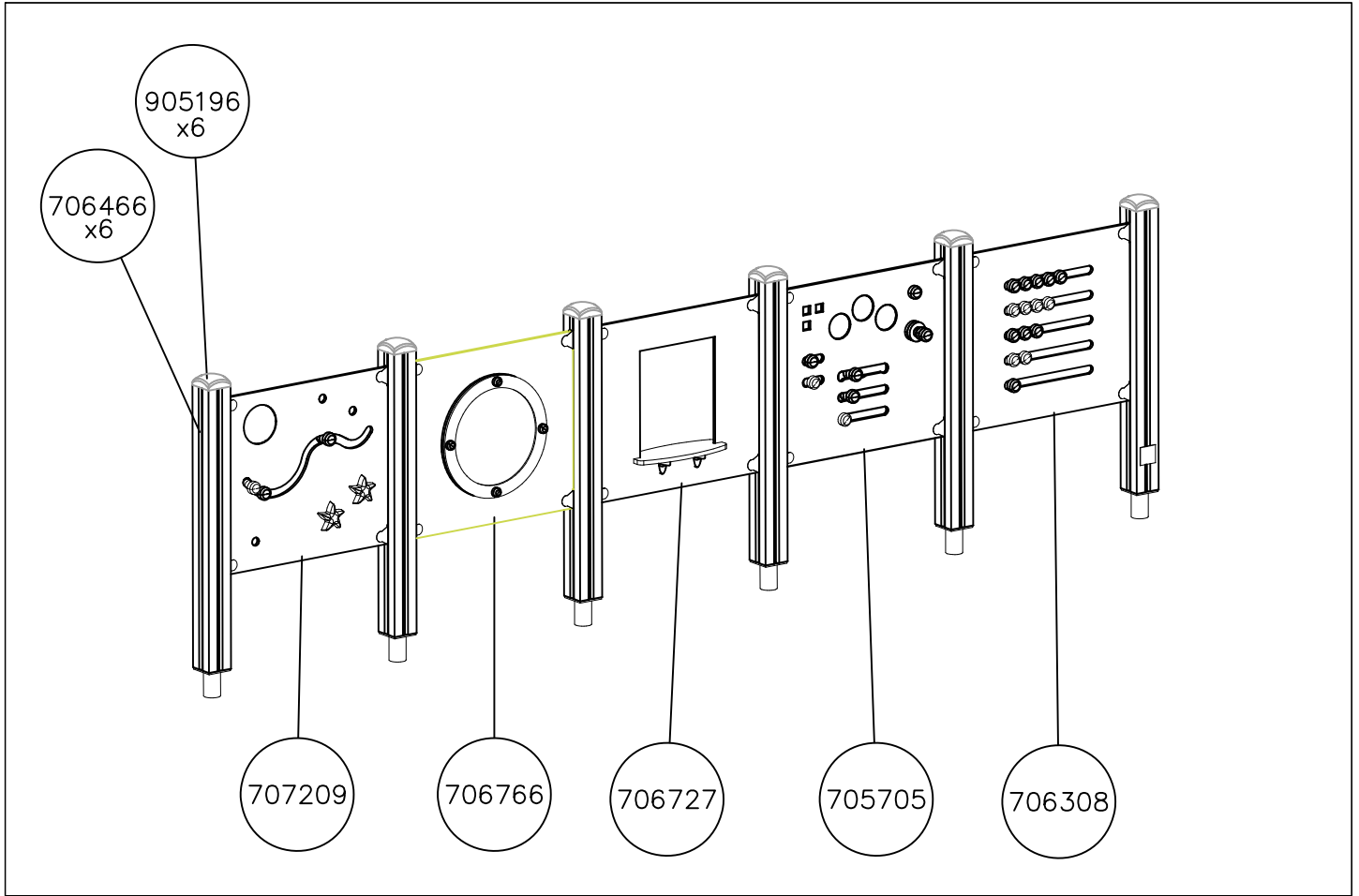

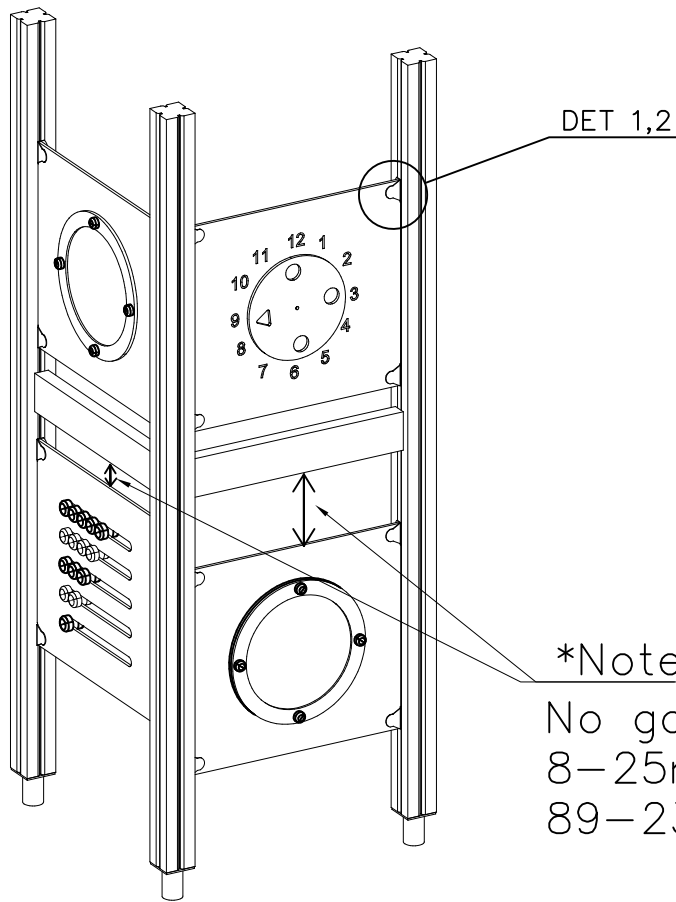

① 903176	PCS	② 909850	PCS
	4		4
		M8x25	
③ 909256	PCS	④ 909633	PCS
	8		4
Ø16/8.4x1.6		M8	
⑤ 980123	PCS		PCS
	4		
Ø7x60			

*Note:

No gaps between:
8–25mm
89–230mm

COLOR OPTIONS

-701	BLUE
-702	YELLOW
-703	LIME
-704	DARK GRAY
-705	LIGHT GRAY
-706	RED
-707	GREEN
-708	FUXIA

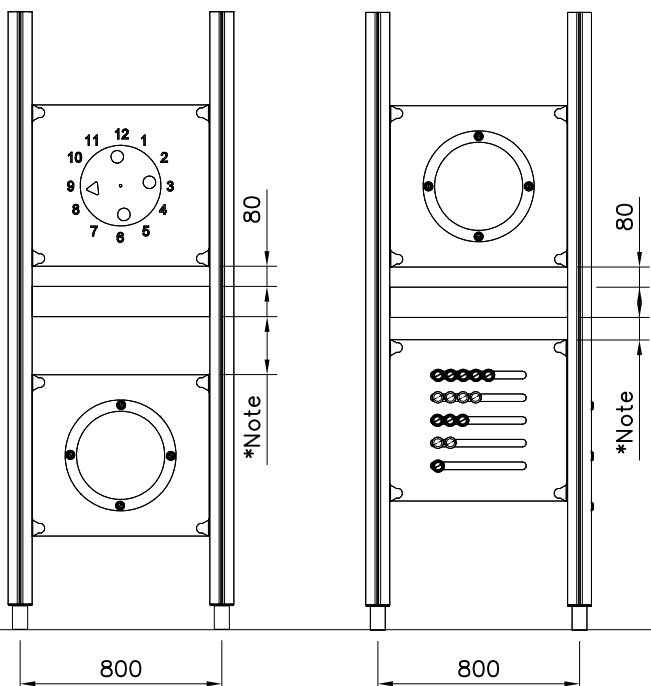

GAME WALL OPTIONS

706766	706772	706308	707453
			
640x702	640x702	640x702	640x702
707209	705705	707433	707386
			
640x702	640x702	640x702	640x702
709403	709358	709405	
			
640x702	640x702	420x702	

DET 1



DET 2





① 706727	PCS	② 706744	PCS
	1		1
10x702x640		15x145x380	
③ 901570	PCS	④ 903176	PCS
	4		4
36x55x55			
⑤ 909855	PCS	⑥ 909850	PCS
	2		8
M8x35		M8x25	
⑦ 909256	PCS	⑧ 980150	PCS
	8		6
Ø16/8.4x1.6		M8	
⑨ 909633	PCS	⑩ 980123	PCS
	4		4
M8		Ø7x60	
		⑪ 905112	PCS
			4
		Ø22	



WALL OPTIONS

706727	706727-701	BLUE
	706727-702	YELLOW
	706727-703	LIME
	706727-704	DARK GRAY
	706727-705	LIGHT GRAY
	706727-706	RED
	706727-707	GREEN
	706727-708	FUXIA

WALL OPTIONS

706744	706744	DARK GRAY
15x145x380		

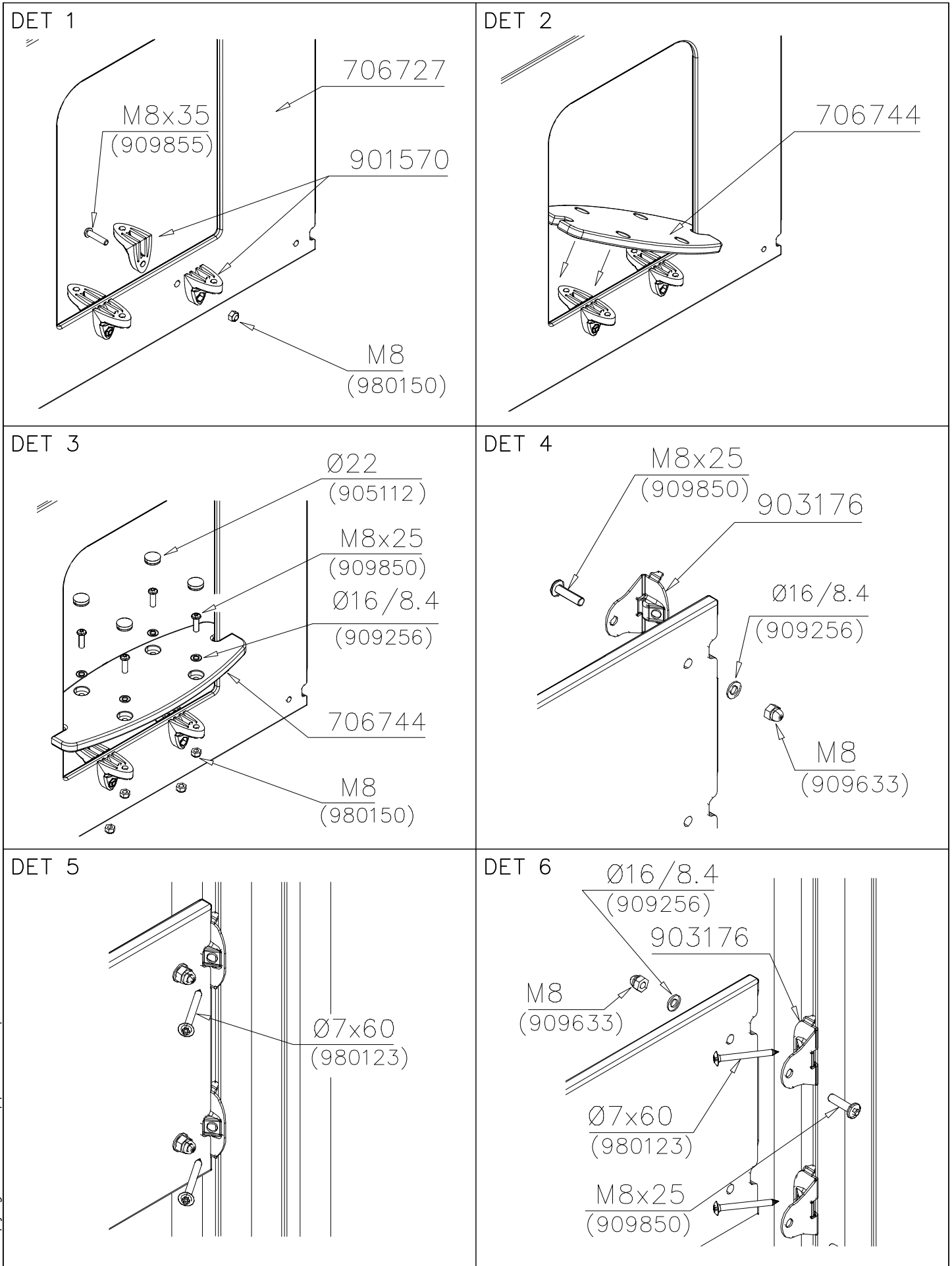

**Tuotekyltti tulee tuotteen mukana yhdellä seuraavista tavoista:****1) Metallinen tuotekyltti ja kiinnitysruuvit**

- Kiinnitä tuotekyltti ruuveilla tolppaan noin 2 metrin korkeuteen kuvan 1 mukaisesti.

2) Tuotekylttitarra

- Puhdista maalattu metalli- tai vaneripinta pölystä ja kosteudesta. Liimaa tarra kuvan 2 mukaisesti.
- Huom. Älä kiinnitä tarraa karheapintaiseen laminaattiin tai maalattuun puuhun.

Vår produktmärkning levereras på ett av följande sätt:**1) Produktskylt i metall**

- Fäst skylten med de medföljande skruvarna

2) Självhäftande produktetikett

- Rengör den pulverlackerade metallytan eller laminatyten så att den blir fri från smuts och fukt. Fäst etiketten enligt fig. 2.
- Obs! Fäst ej etiketten på detaljer med skrovlig yta eller på målat trä.

Product label is delivered by one of following ways:**1) Metal product label and screws**

- Fasten the label with screws.

2) Label sticker

- Clean the painted metal or plywood surface from dirt and moisture. Fasten the sticker as shown in the figure 2.
- Note. Do not attach the sticker to rough surfaced laminate or painted wood.

La plaque d'informations produit est livrée sous l'une de ces 3 formes :**1) Plaque métallique et vis**

- Fixez la plaque à l'aide des vis.

2) Etiquette autocollante

- Avant de coller l'étiquette, nettoyez le composant métallique peint ou la plaque de contreplaqué, de toute saleté. La surface doit être sèche (voir image 2).
- Attention, ne pas coller l'étiquette sur une surface lamellé-collée irrégulière ou sur du bois peint.

Die Auslieferung des Produktaufklebers erfolgt auf eine dieser Arten:**1) Produkt-Schild aus Metall incl. Schrauben**

- Die Befestigung des Schildes erfolgt mittels der Schrauben.

2) Aufkleber

- Entfernen Sie zunächst Schmutz und Feuchtigkeit vom lackierten Metall bzw. von der Holzoberfläche und bringen Sie den Aufkleber wie im Bild oben rechts beschrieben auf den gesäuberten Untergrund auf.
- Beachten Sie: Bringen Sie den Aufkleber nicht auf raues laminiertes oder lackiertes Holz an.

LAPPSET®
DEEP FOUNDATION

FOOT

DATE: 13.3.2014

4A



LAPPSET®
BETON FOUNDATION

FOOT

DATE: 27.10.2015

1(1)

② 905104	PCS		PCS
	4		
 M10	PCS		PCS



905104

LAPPSET® DEEP FOUNDATION

FOOT

DATE: 15.5.2018

1(1)



①	909511	PCS	②	909519	PCS
		1			1
	90x90x650			50x380x380	

③	909637	PCS	④	909638	PCS
		4			8
	M10			Ø20/10.5	

⑤	909639	PCS	⑥	905104	PCS
		4			4
	M10x25			M10	

OPTION FOOT

①	911155	PCS			PCS
		1			
	90x90x650				