

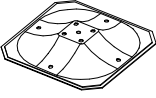



①	909511	PCS	②	909519	PCS
		1			1
③	909637	PCS	④	909638	PCS
		4			8
	M10			Ø20/10.5	
⑤	909639	PCS			PCS
		4			
	M10x25				
		PCS			PCS
		PCS			PCS
		PCS			PCS
		PCS			PCS
		PCS			PCS

DET 1



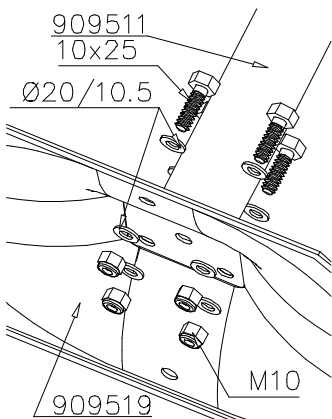

**Tuotekyltti tulee tuotteen mukana yhdellä seuraavista tavoista:****1) Metallinen tuotekyltti ja kiinnitysruuvit**

- Kiinnitä tuotekyltti ruuveilla tolppaan noin 2 metrin korkeuteen kuvan 1 mukaisesti.

2) Tuotekylttitarra

- Puhdista maalattu metalli- tai vaneripinta pölystä ja kosteudesta. Liimaa tarra kuvan 2 mukaisesti.
- Huom. Älä kiinnitä tarraa karheapintaiseen laminaattiin tai maalattuun puuhun.

Vår produktmärkning levereras på ett av följande sätt:**1) Produktskylt i metall**

- Fäst skylten med de medföljande skruvarna

2) Självhäftande produktetikett

- Rengör den pulverlackerade metallytan eller laminatyten så att den blir fri från smuts och fukt. Fäst etiketten enligt fig. 2.
- Obs! Fäst ej etiketten på detaljer med skrovlig yta eller på målat trä.

Product label is delivered by one of following ways:**1) Metal product label and screws**

- Fasten the label with screws.

2) Label sticker

- Clean the painted metal or plywood surface from dirt and moisture. Fasten the sticker as shown in the figure 2.
- Note. Do not attach the sticker to rough surfaced laminate or painted wood.

La plaque d'informations produit est livrée sous l'une de ces 3 formes :**1) Plaque métallique et vis**

- Fixez la plaque à l'aide des vis.

2) Etiquette autocollante

- Avant de coller l'étiquette, nettoyez le composant métallique peint ou la plaque de contreplaqué, de toute saleté. La surface doit être sèche (voir image 2).
- Attention, ne pas coller l'étiquette sur une surface lamellé-collée irrégulière ou sur du bois peint.



Die Auslieferung des Produktaufklebers erfolgt auf eine dieser Arten:**1) Produkt-Schild aus Metall incl. Schrauben**

- Die Befestigung des Schildes erfolgt mittels der Schrauben.

2) Aufkleber

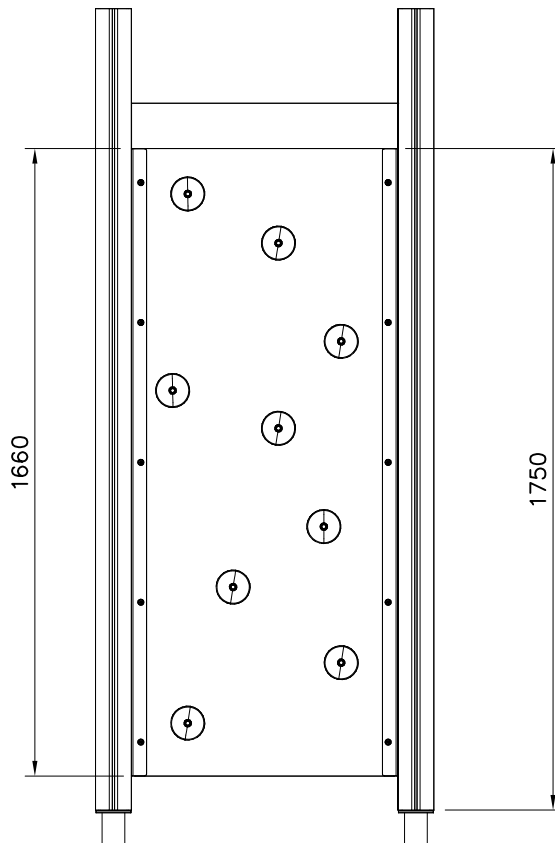
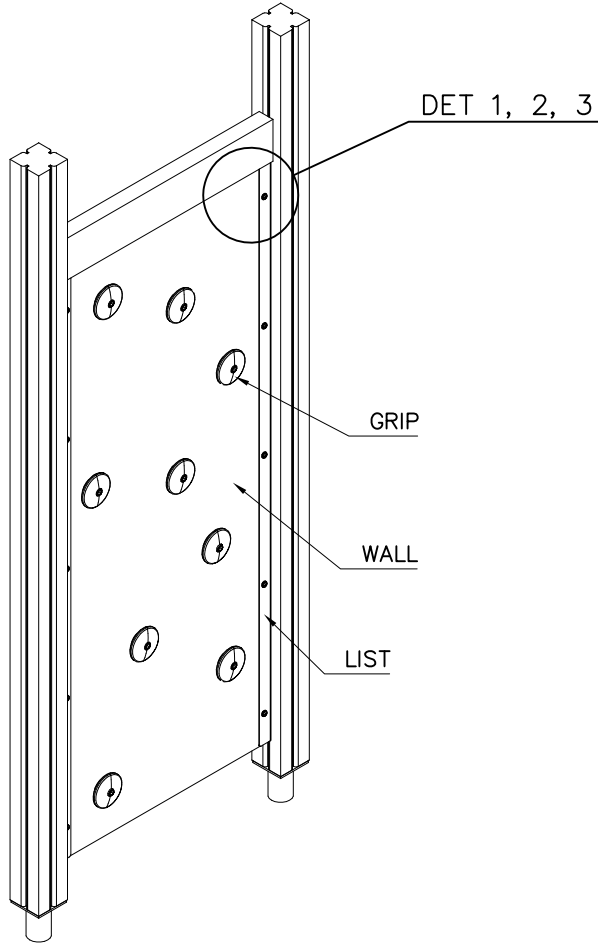
- Entfernen Sie zunächst Schmutz und Feuchtigkeit vom lackierten Metall bzw. von der Holzoberfläche und bringen Sie den Aufkleber wie im Bild oben rechts beschrieben auf den gesäuberten Untergrund auf.
- Beachten Sie: Bringen Sie den Aufkleber nicht auf raues laminiertes oder lackiertes Holz an.

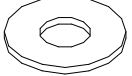
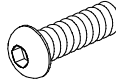
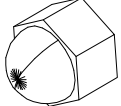
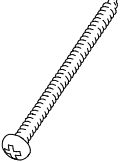

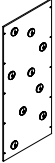
① 909256	PCS	② 980152	PCS
	10		10
Ø16/8.4x1.6		Ø24/8.4x2	
③ 909850	PCS	④ 909633	PCS
	10		10
M8x25		M8	
	PCS	⑤ 980131	PCS
			10
		Ø6x60	
	PCS		PCS
	PCS		PCS
	PCS		PCS
○ 907770	PCS	○ 706646 + grips	PCS
	2		1
2x35/40x1659			
	PCS		PCS

DET 1

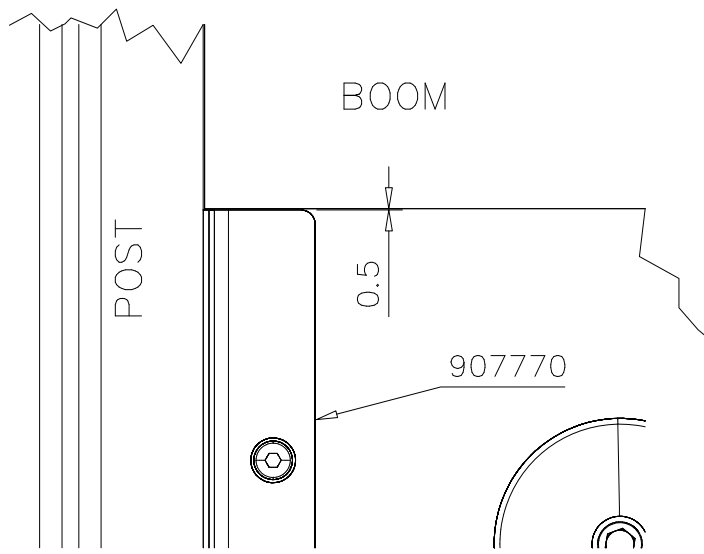



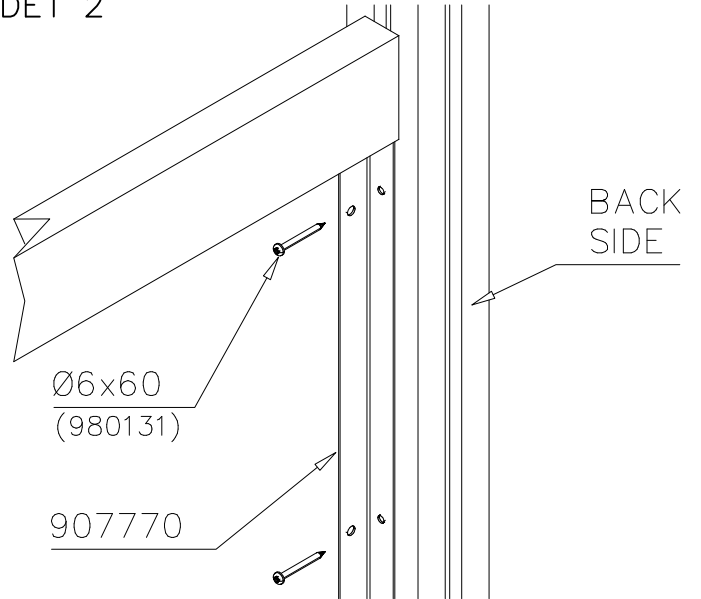



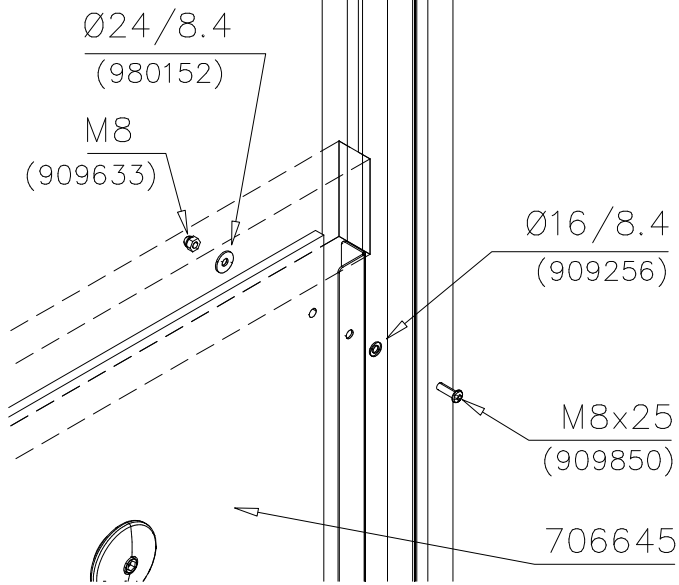

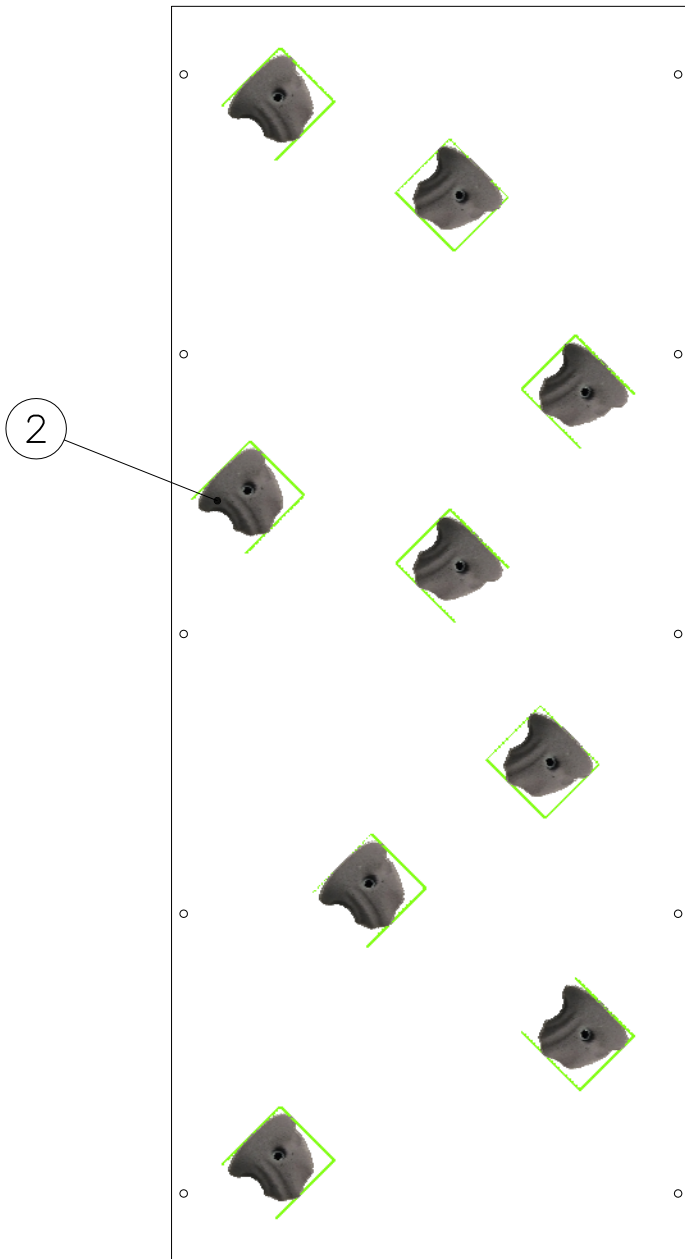
DET 2

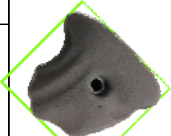

DET 3





①	904336	PCS	②*	906746	PCS
		9			9
				Size L, Grey	
	Ø6x20				
③	902232	PCS	④	905090	PCS
		9			9
				Ø45	
	M10x55				
⑤	901302	PCS	⑥	909637	PCS
		9			9
				M10	
	Ø20/10.5				
⑦	905115	PCS			PCS
		9			
					
	Ø30				
		PCS			PCS
		PCS			PCS
○	706646	PCS			PCS
		1			
					
	12x686x1660				
		PCS			PCS

HUOM!

Otepalan asennus, säätö tai paikan vaihto.
Säätömahdollisuus (90°,180°,270°).

Jos asennetun otepalan suuntaa- tai paikkaa halutaan muuttaa. Irrota otepalan kiinnityspultti ja otepala, käännä tai vaihda. Siirrä tarvittaessa tappi oikeaan upotusreikään. Asenna avatut osat paikoilleen ja lopuksi kiinnitä muovitulppa Ø30 paikoilleen kaikkiin otekokoonpanoihin.

NOTE:

Grip positions and angles are adjustable (90°,180°270°).

Grip can be repositioned by removing the fastening bolt and pulling the grip off.
Securing pin can be repositioned when angle is changed.
After the parts are reassembled. Finish the assembly by fastening the cover plugs (Ø30).

