

# LAPPSET®

## ARENA



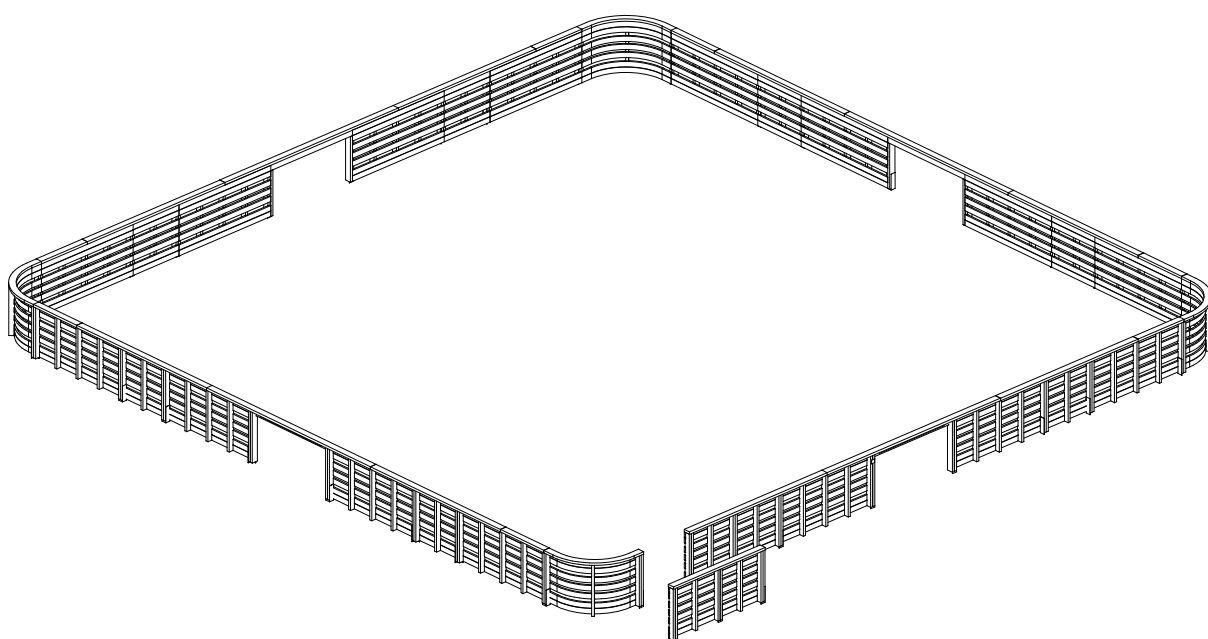

ASENNUSOHJE  
MONTERINGSANSVISNING  
INSTALLATION INSTRUCTION  
AUFBAUANLEITUNG  
NOTICE D'INSTALLATION

DATE: 18.4.2019

### Q13755-1

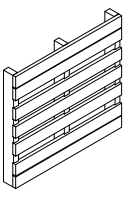
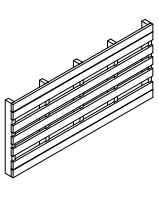
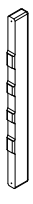
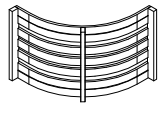
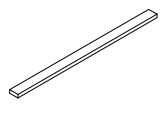
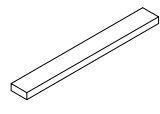

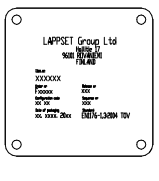
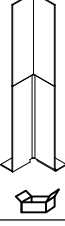
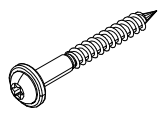
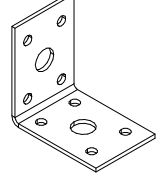
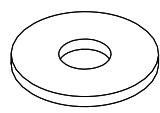
DATE: 18.4.2019

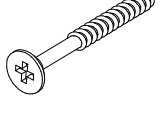
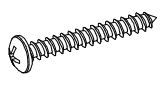
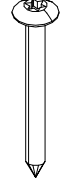
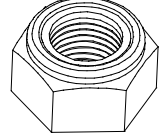
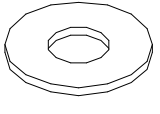
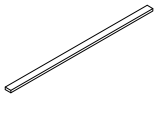
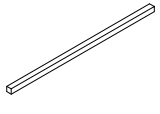
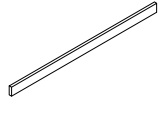
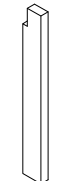
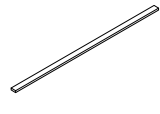
702019  L 1000	PCS 9	702021  L 2000	PCS 16	702022  L 910	PCS 5	702038  702038	PCS 4	702227  L 2000	PCS 1	702228  L 1000	PCS 7
702248  702248	PCS 4	702286  65x65	PCS 1	708383  708383	PCS 36	900240  Ø8x70	PCS 39	902434  902434	PCS 81	905051  Ø24/8.4	PCS 198
909203  M8x75	PCS 99	980101  Ø4.5x70	PCS 16	980107  Ø6x60	PCS 98	980114  Ø4x20	PCS 4	980128  Ø7x40	PCS 162	980150  M8	PCS 99
980152  Ø24/8.4	PCS 39	P01444  L 3000	PCS 8	P07684  45x45x1400	PCS 4	P13320  L 1780	PCS 4	P13321  L 910	PCS 8	P13322  L 3780	PCS 4
	PCS		PCS		PCS		PCS		PCS		PCS
	PCS		PCS		PCS		PCS		PCS		PCS
	PCS		PCS		PCS		PCS		PCS		PCS

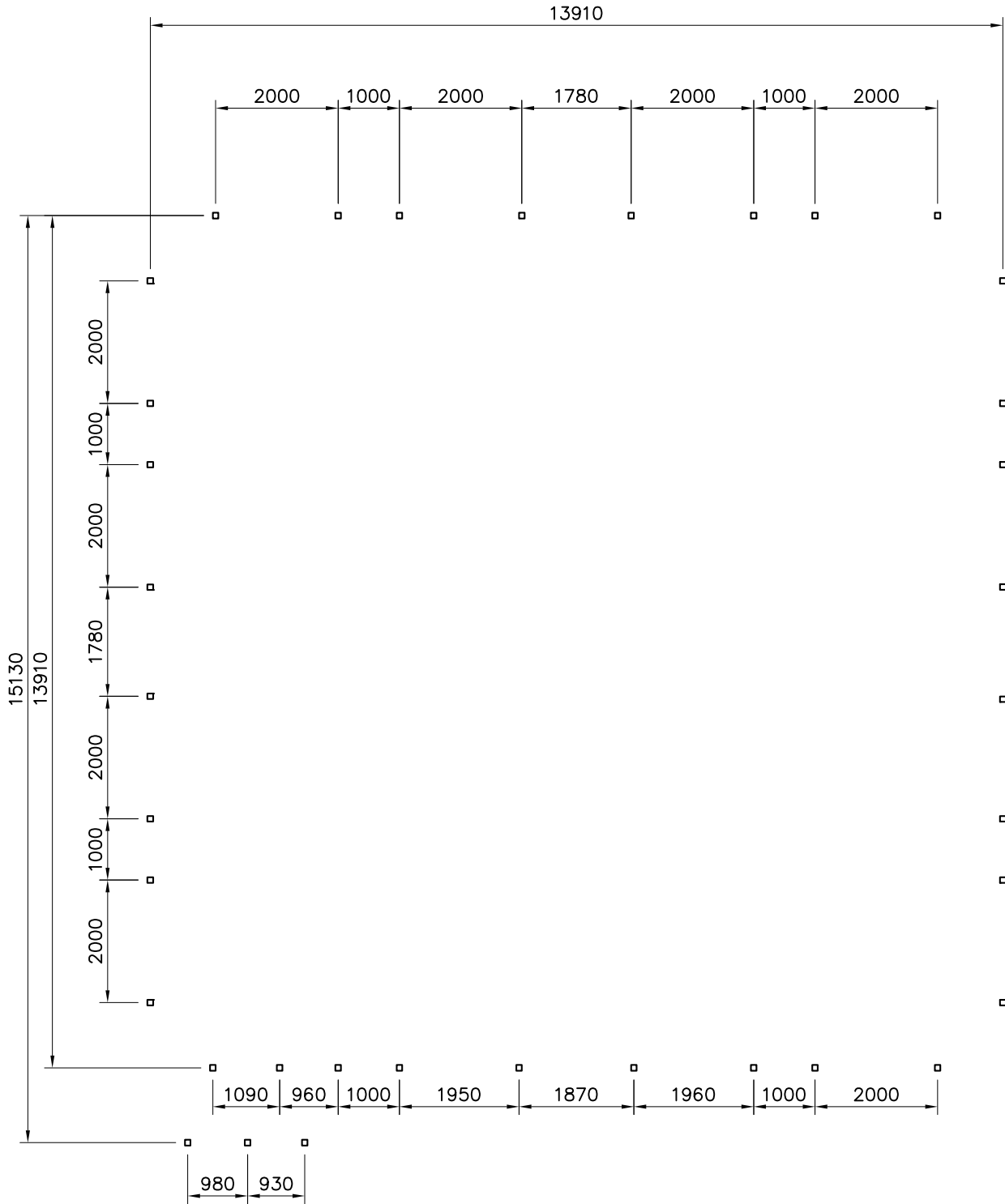

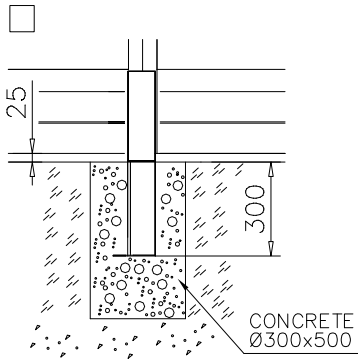

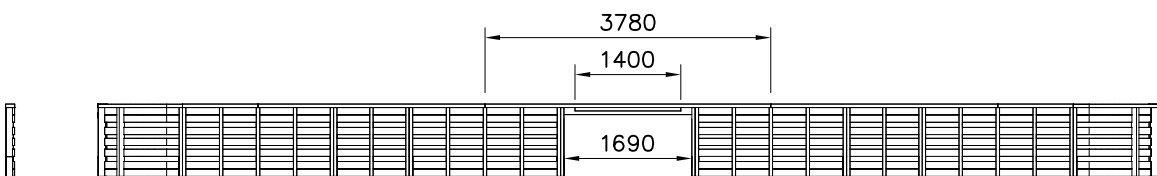
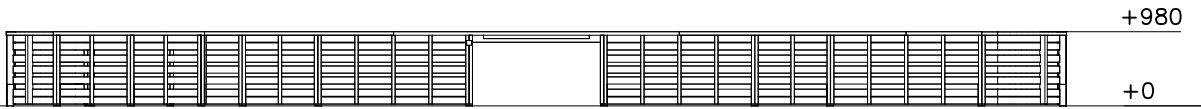

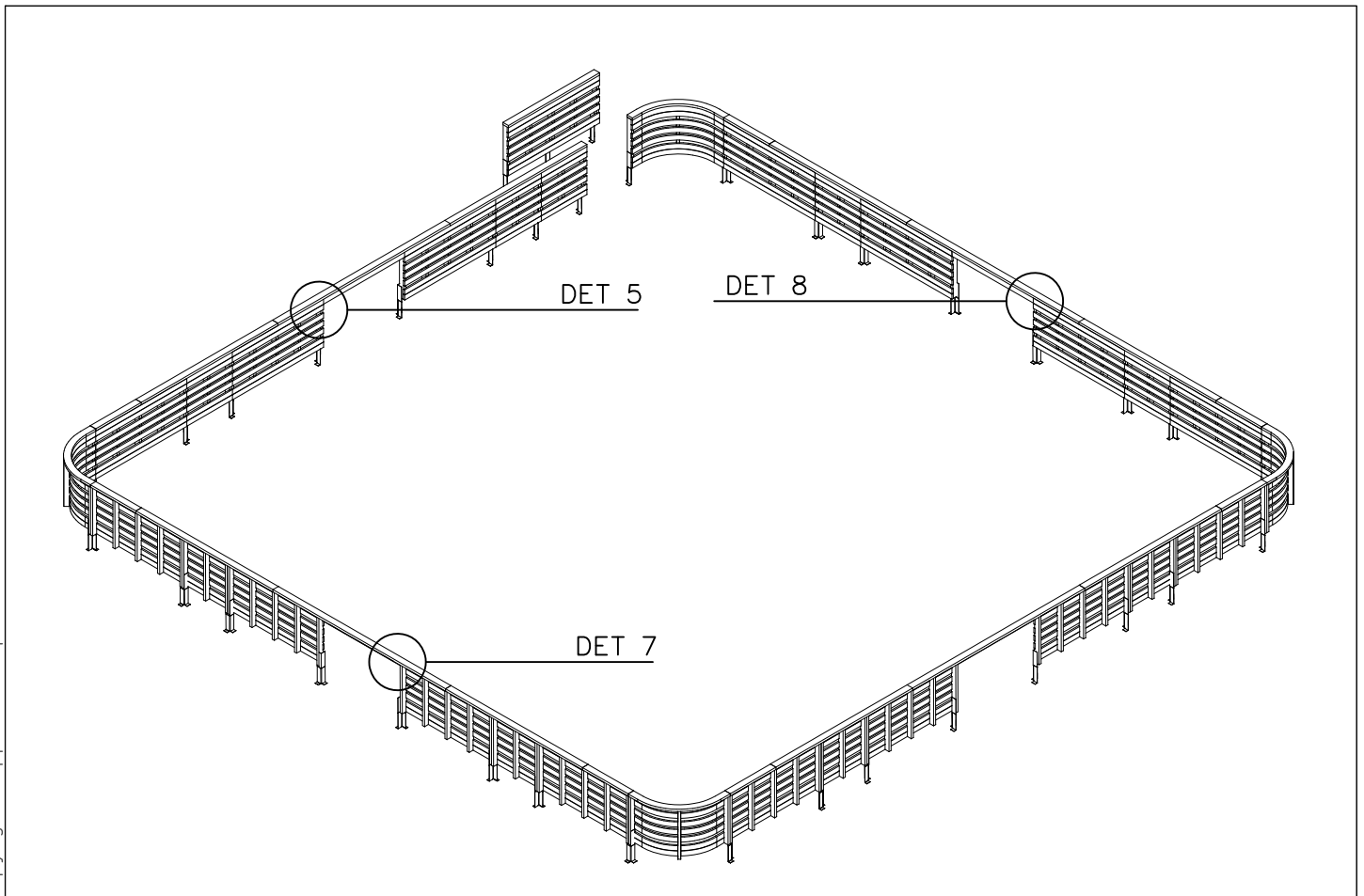
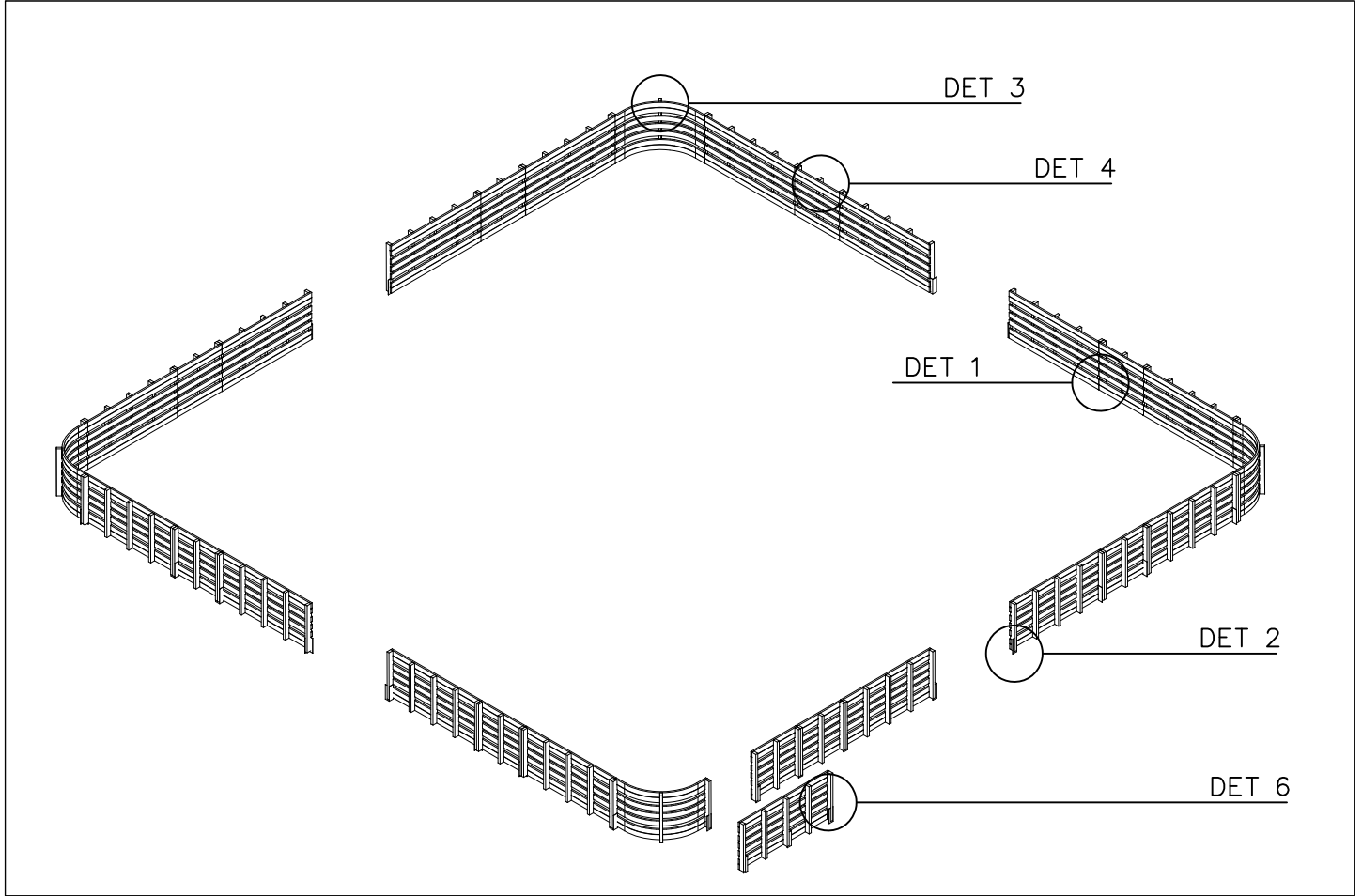

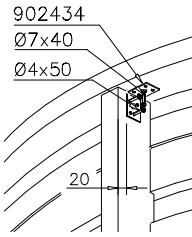

<p>DET 1</p> <p>M8          Ø24/8.4          M8x75</p>	<p>DET 2</p> <p>8x70</p>	<p>DET 3</p> <p>902434          Ø7x40          Ø4x50          20</p>	<p>DET 4</p> <p>902434          Ø7x40          Ø4x50          20</p>
<p>DET 5</p> <p>Ø8x70          900240          Ø24/8.4          980152</p>		<p>DET 6</p> <p>702022          Ø8x70          900240          Ø24/8.4          980152</p>	
<p>DET 7</p> <p>Ø6x60          980107</p>	<p>DET 8</p> <p>Ø4.5x70          980101</p>		

<p>DET 1</p> 	<p>DET 2</p> 	<p>DET 3</p> 	<p>DET 4</p> 
<p>DET 5</p>	<p>DET 6</p>		



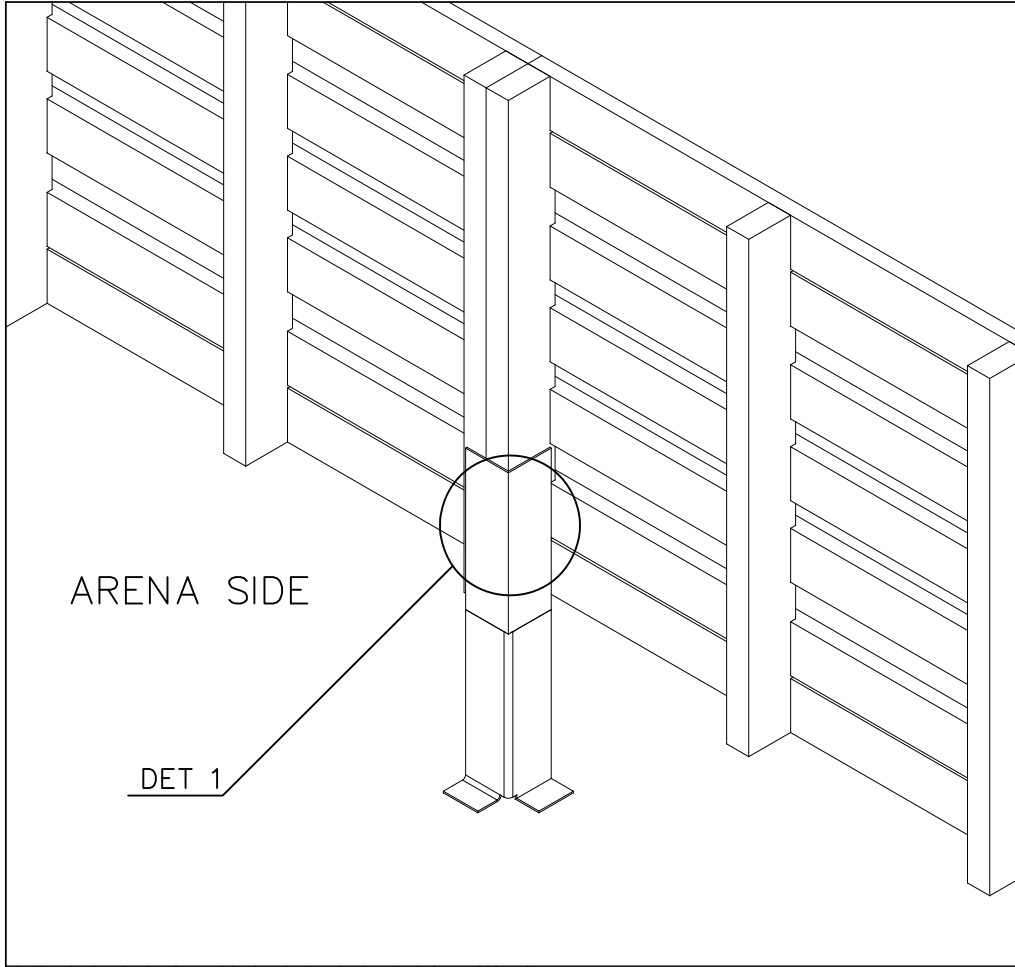

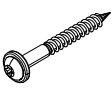

① 902433	PCS	② 900240	PCS
	1		6
		Ø8x70	
	PCS		PCS
	PCS		PCS
	PCS		PCS

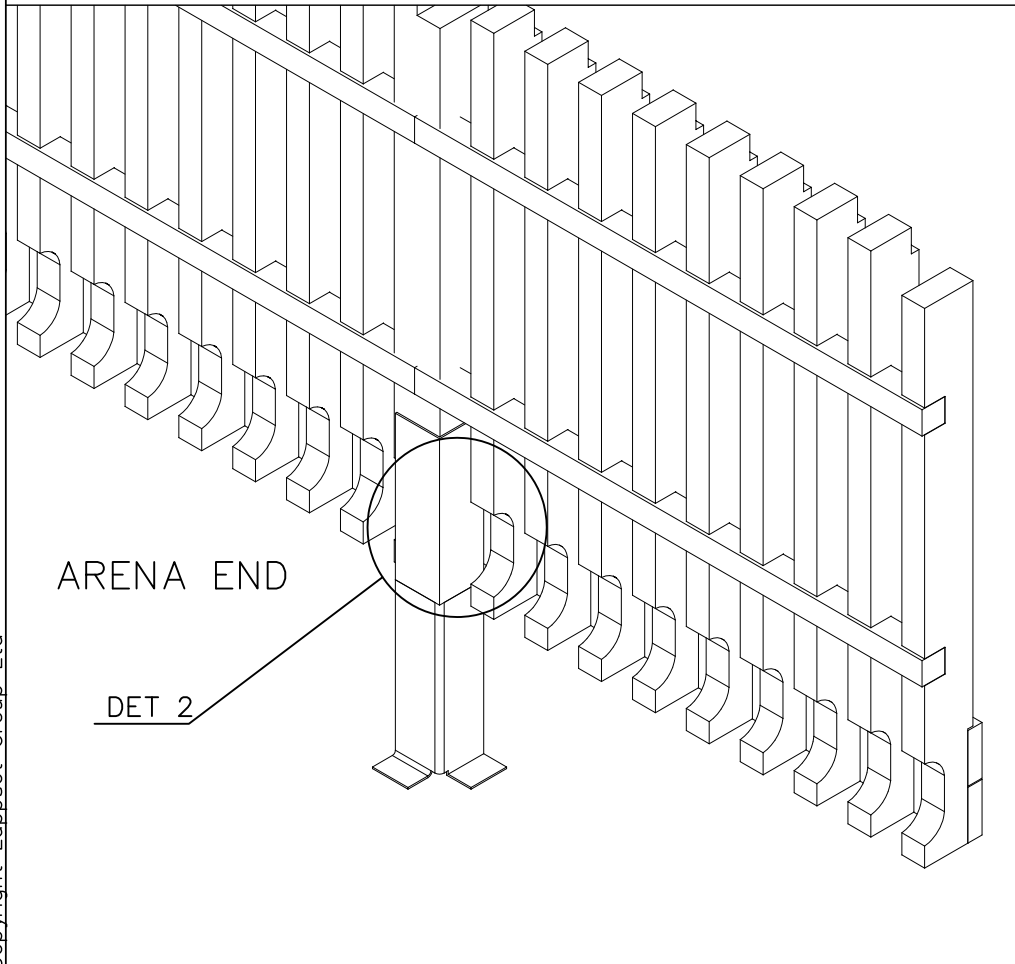

DET 1 ARENA SIDE

DET 2 ARENA END

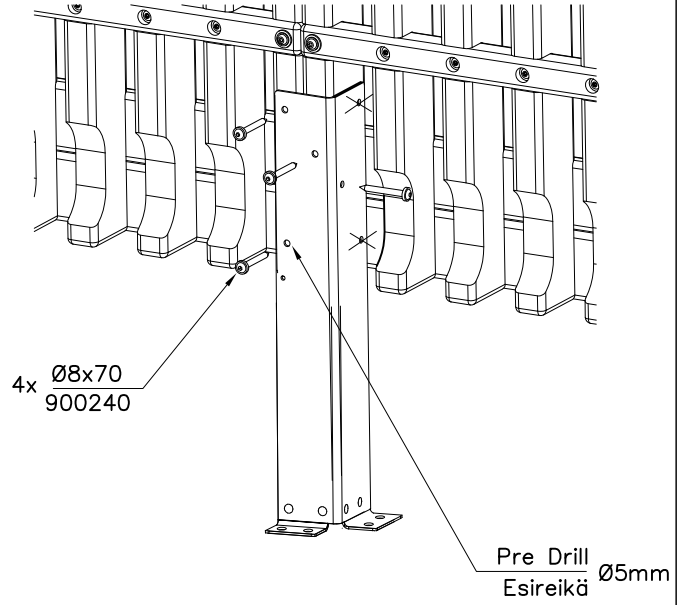
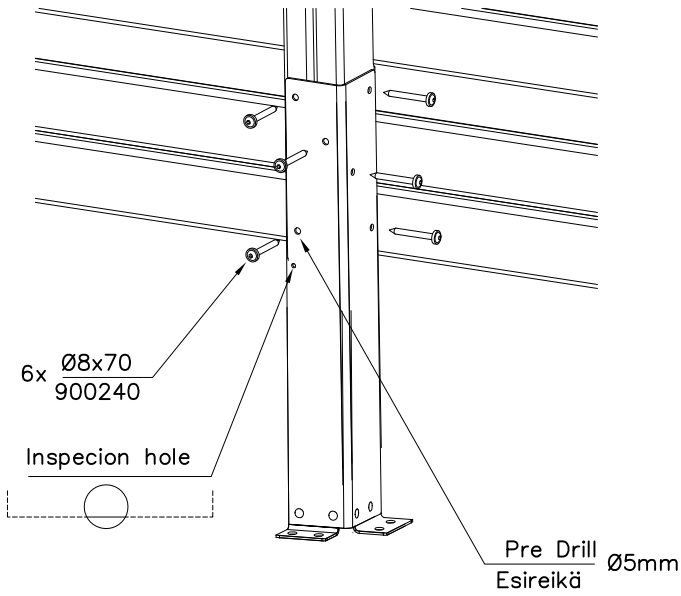

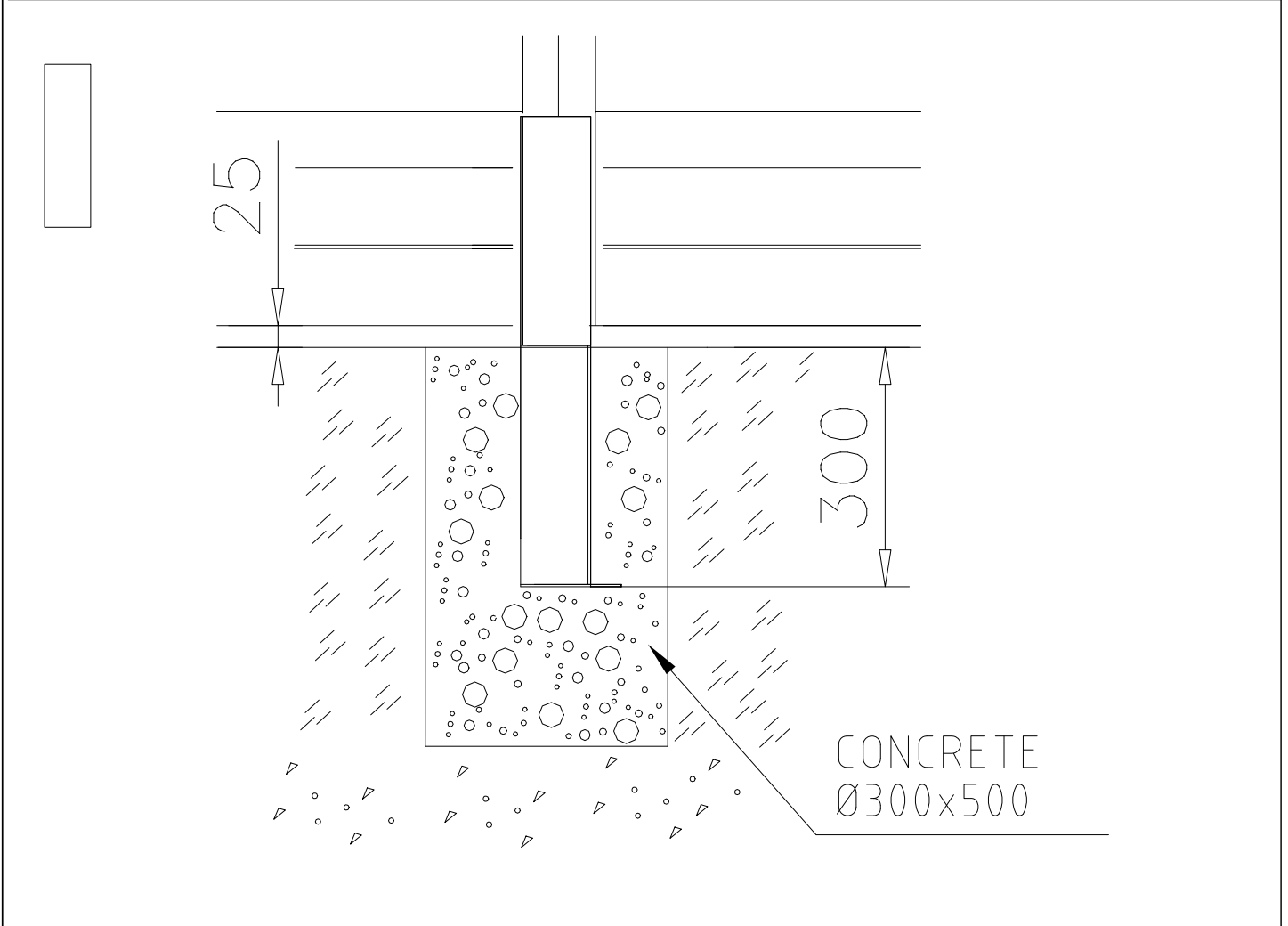
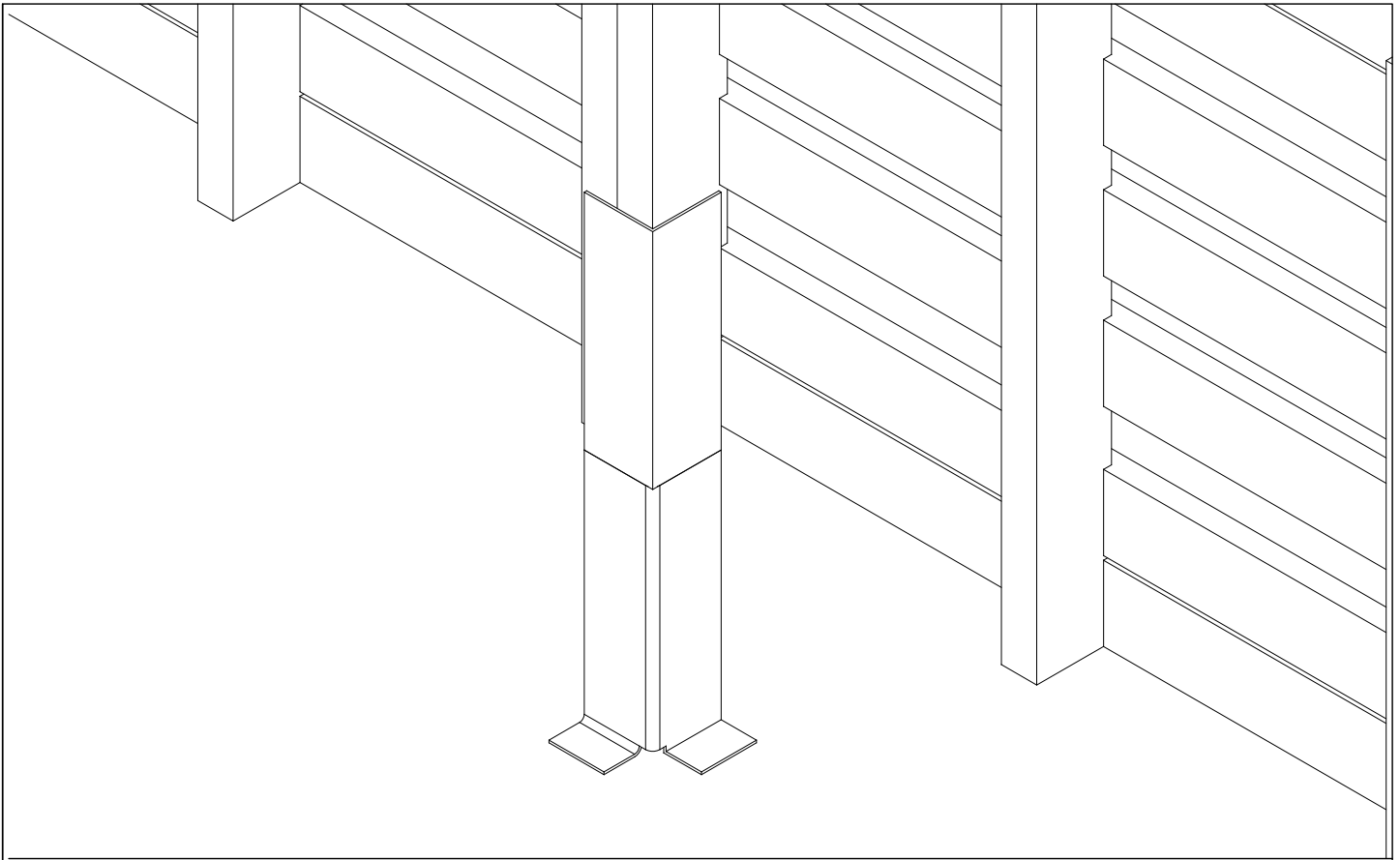

**Tuotekyltti tulee tuotteen mukana yhdellä seuraavista tavoista:****1) Metallinen tuotekyltti ja kiinnitysruuvit**

- Kiinnitä tuotekyltti ruuveilla tolppaan noin 2 metrin korkeuteen kuvan 1 mukaisesti.

**2) Tuotekylttitarra**

- Puhdista maalattu metalli- tai vaneripinta pölystä ja kosteudesta. Liimaa tarra kuvan 2 mukaisesti.
- Huom. Älä kiinnitä tarraa karheapintaiseen laminaattiin tai maalattuun puuhun.

**Vår produktmärkning levereras på ett av följande sätt:****1) Produktskylt i metall**

- Fäst skylten med de medföljande skruvarna

**2) Självhäftande produktetikett**

- Rengör den pulverlackerade metallytan eller laminatyten så att den blir fri från smuts och fukt. Fäst etiketten enligt fig. 2.
- Obs! Fäst ej etiketten på detaljer med skrovlig yta eller på målat trä.

**Product label is delivered by one of following ways:****1) Metal product label and screws**

- Fasten the label with screws.

**2) Label sticker**

- Clean the painted metal or plywood surface from dirt and moisture. Fasten the sticker as shown in the figure 2.
- Note. Do not attach the sticker to rough surfaced laminate or painted wood.

**La plaque d'informations produit est livrée sous l'une de ces 3 formes :****1) Plaque métallique et vis**

- Fixez la plaque à l'aide des vis.

**2) Etiquette autocollante**

- Avant de coller l'étiquette, nettoyez le composant métallique peint ou la plaque de contreplaqué, de toute saleté. La surface doit être sèche (voir image 2).
- Attention, ne pas coller l'étiquette sur une surface lamellé-collée irrégulière ou sur du bois peint.

**Die Auslieferung des Produktaufklebers erfolgt auf eine dieser Arten:****1) Produkt-Schild aus Metall incl. Schrauben**

- Die Befestigung des Schildes erfolgt mittels der Schrauben.

**2) Aufkleber**

- Entfernen Sie zunächst Schmutz und Feuchtigkeit vom lackierten Metall bzw. von der Holzoberfläche und bringen Sie den Aufkleber wie im Bild oben rechts beschrieben auf den gesäuberten Untergrund auf.
- Beachten Sie: Bringen Sie den Aufkleber nicht auf raues laminiertes oder lackiertes Holz an.