

LAPPSET®

ARENA





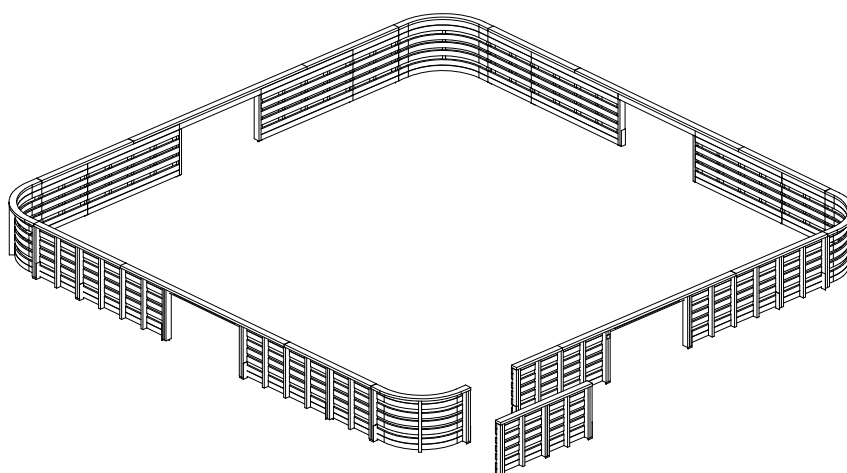

ASENNUSOHJE
MONTERINGSANSVISNING
INSTALLATION INSTRUCTION
AUFBAUANLEITUNG
NOTICE D'INSTALLATION

DATE: 3.2.2022

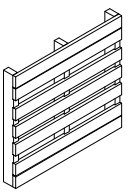
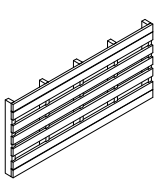
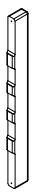
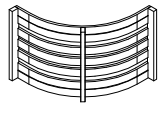
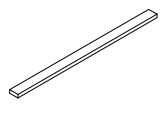
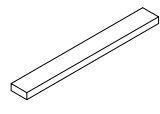
Q13757-1

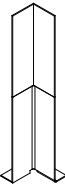
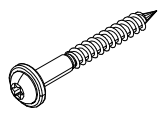
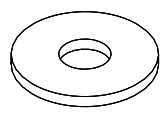

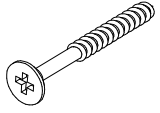
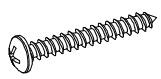
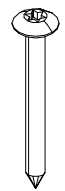
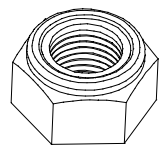
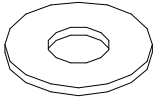
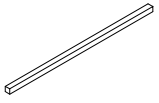
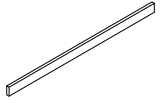
DATE: 3.2.2022

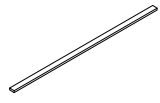
702019  L 1000	PCS 7	702021  L 2000	PCS 9	702022  L 910	PCS 5	702038  L 2000	PCS 4	702227  L 2000	PCS 8	702228  L 1000	PCS 1
702248 	PCS 4	702286  65x65	PCS 1	708383  L 910	PCS 27	900240  Ø8x70	PCS 39	902434 	PCS 58	905051  Ø24/8.4	PCS 144
909203  M8x75	PCS 72	980101  Ø4.5x70	PCS 16	980107  Ø6x60	PCS 168	980114  Ø4x20	PCS 4	980128  Ø7x40	PCS 116	980150  M8	PCS 72
980152  Ø24/8.4	PCS 39	P07684  45x45x1400	PCS 4	P13320  L 1780	PCS 4	P13321  L 910	PCS 8	P13322  L 3780	PCS 4		PCS
	PCS		PCS		PCS		PCS		PCS		PCS
	PCS		PCS		PCS		PCS		PCS		PCS

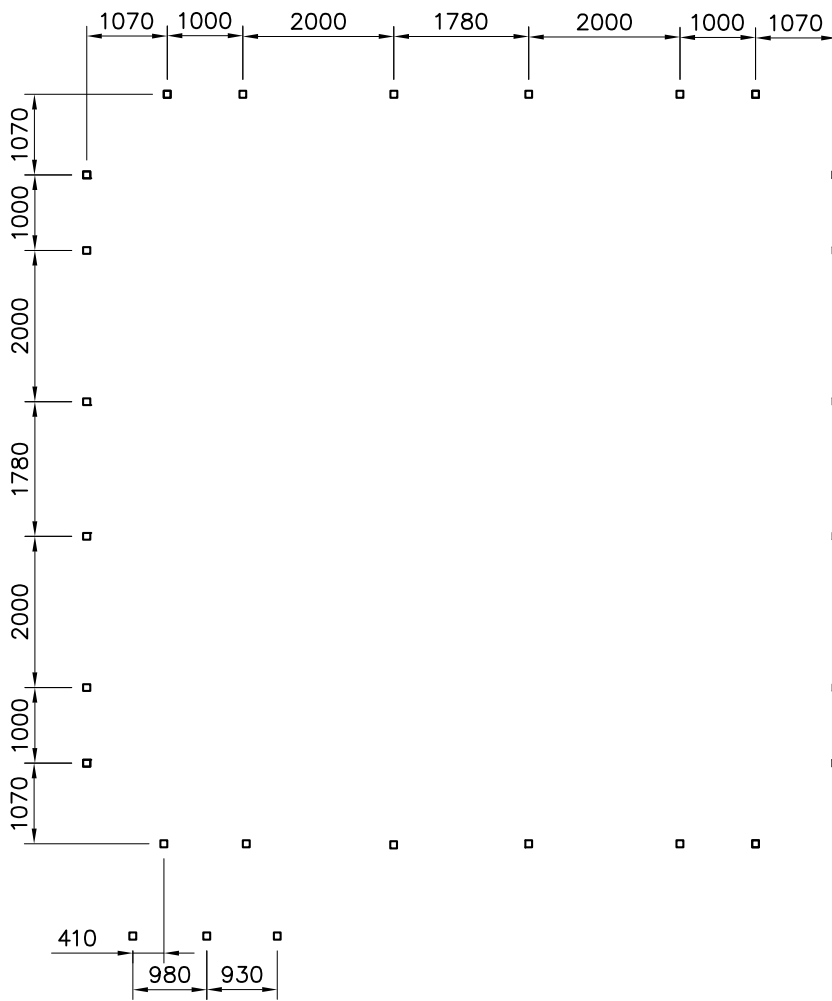
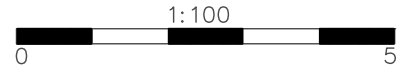

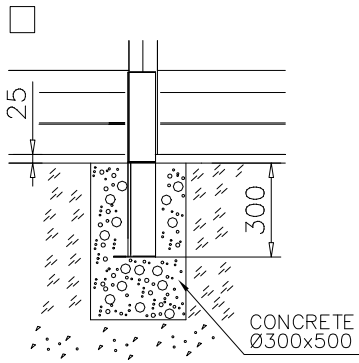

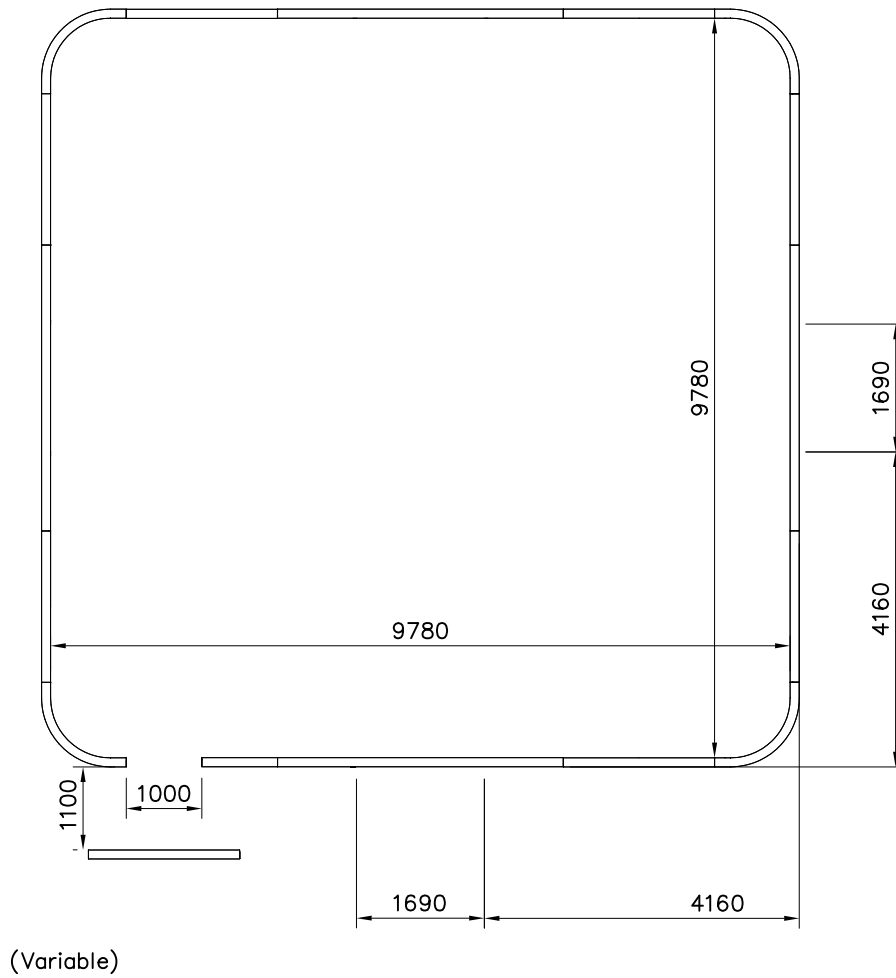
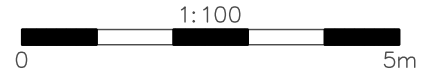

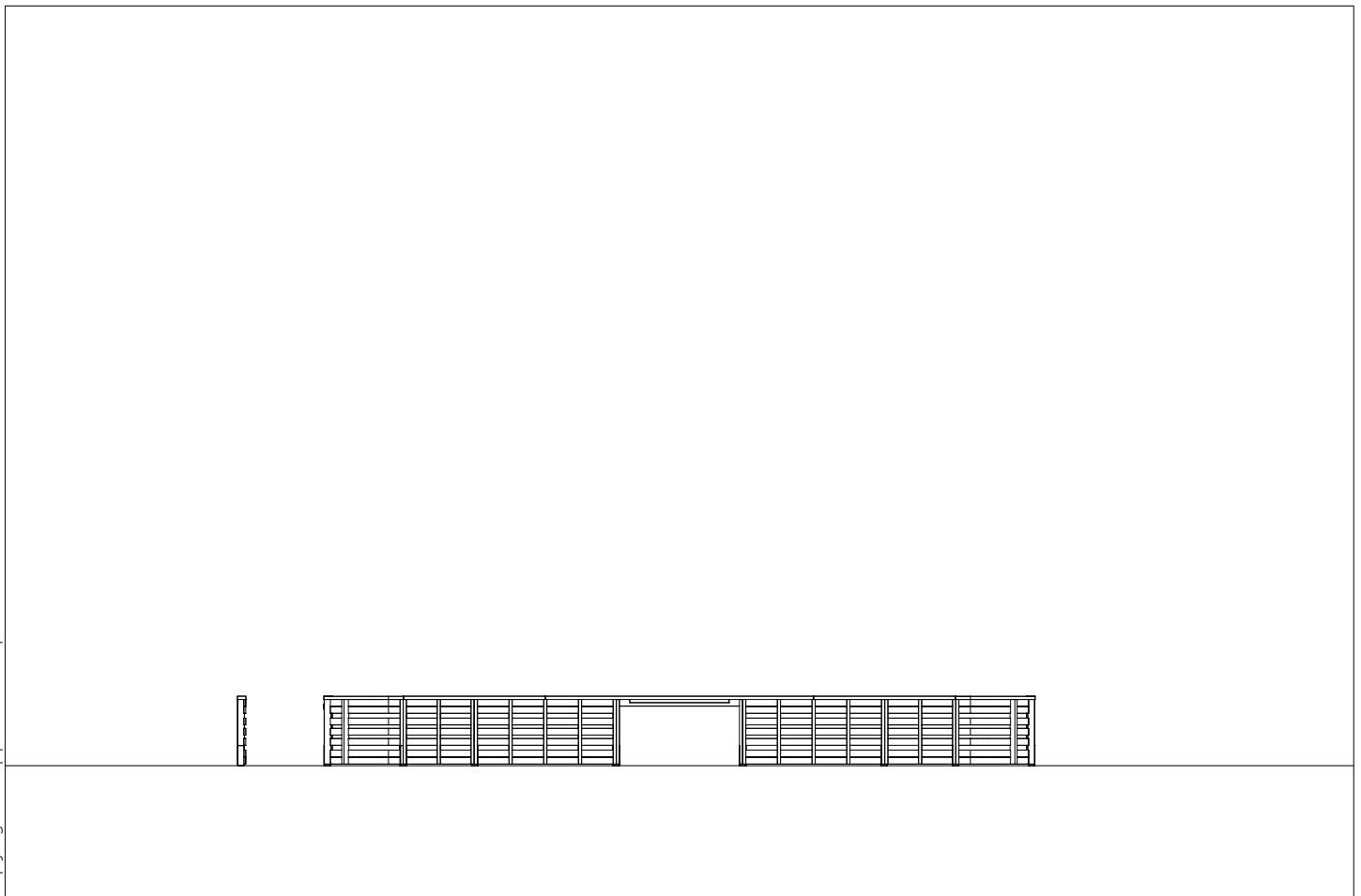
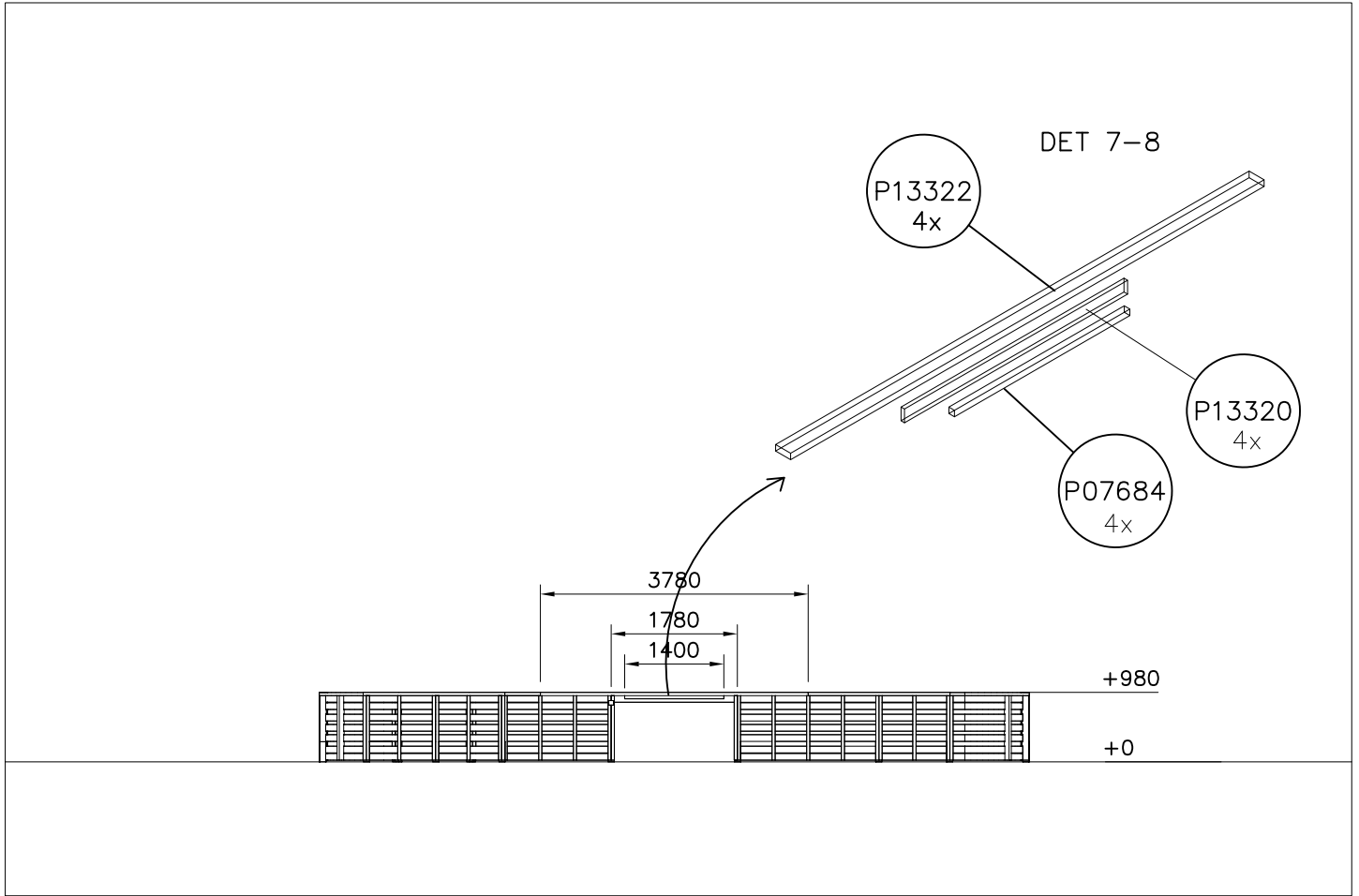

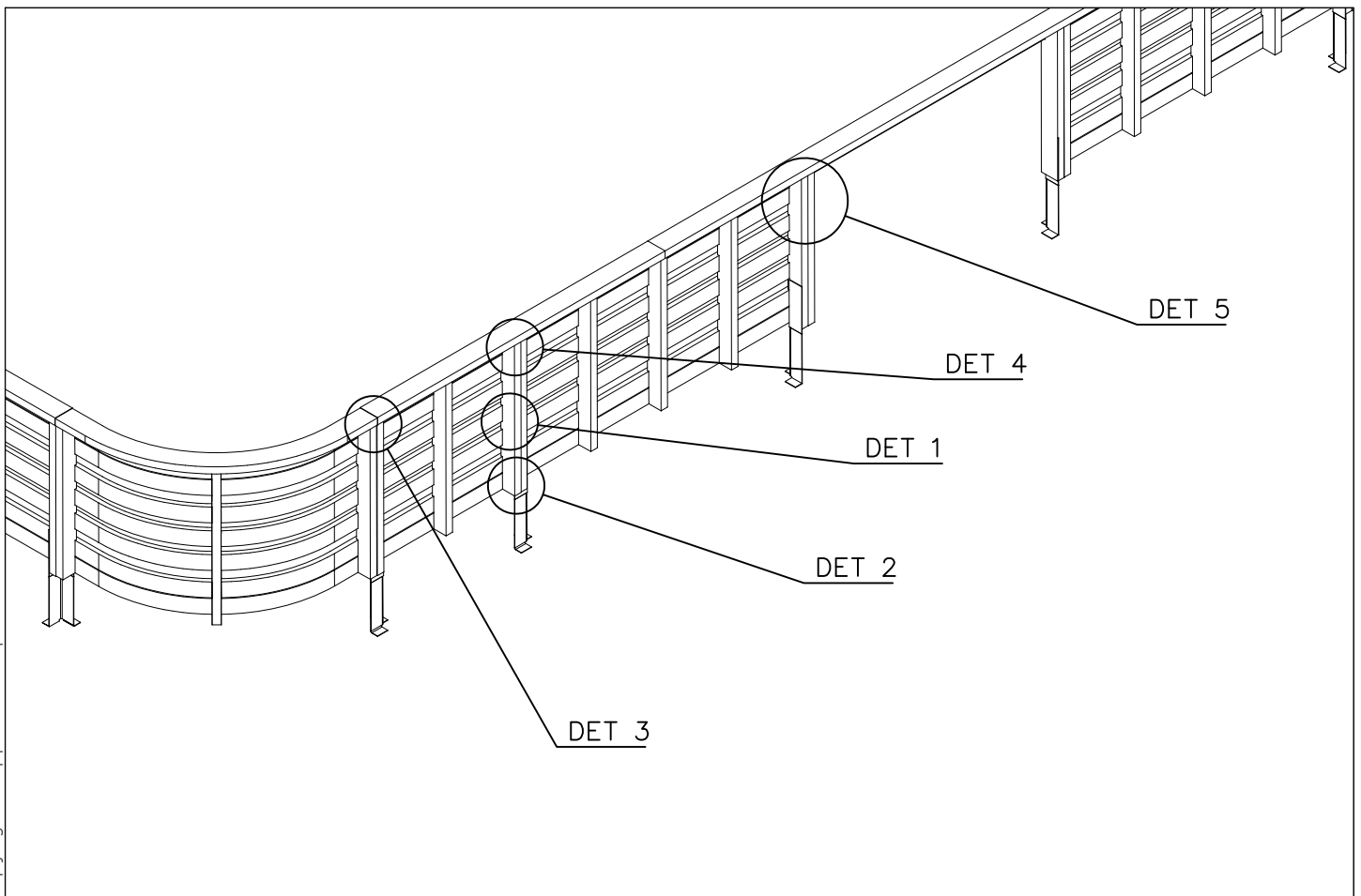
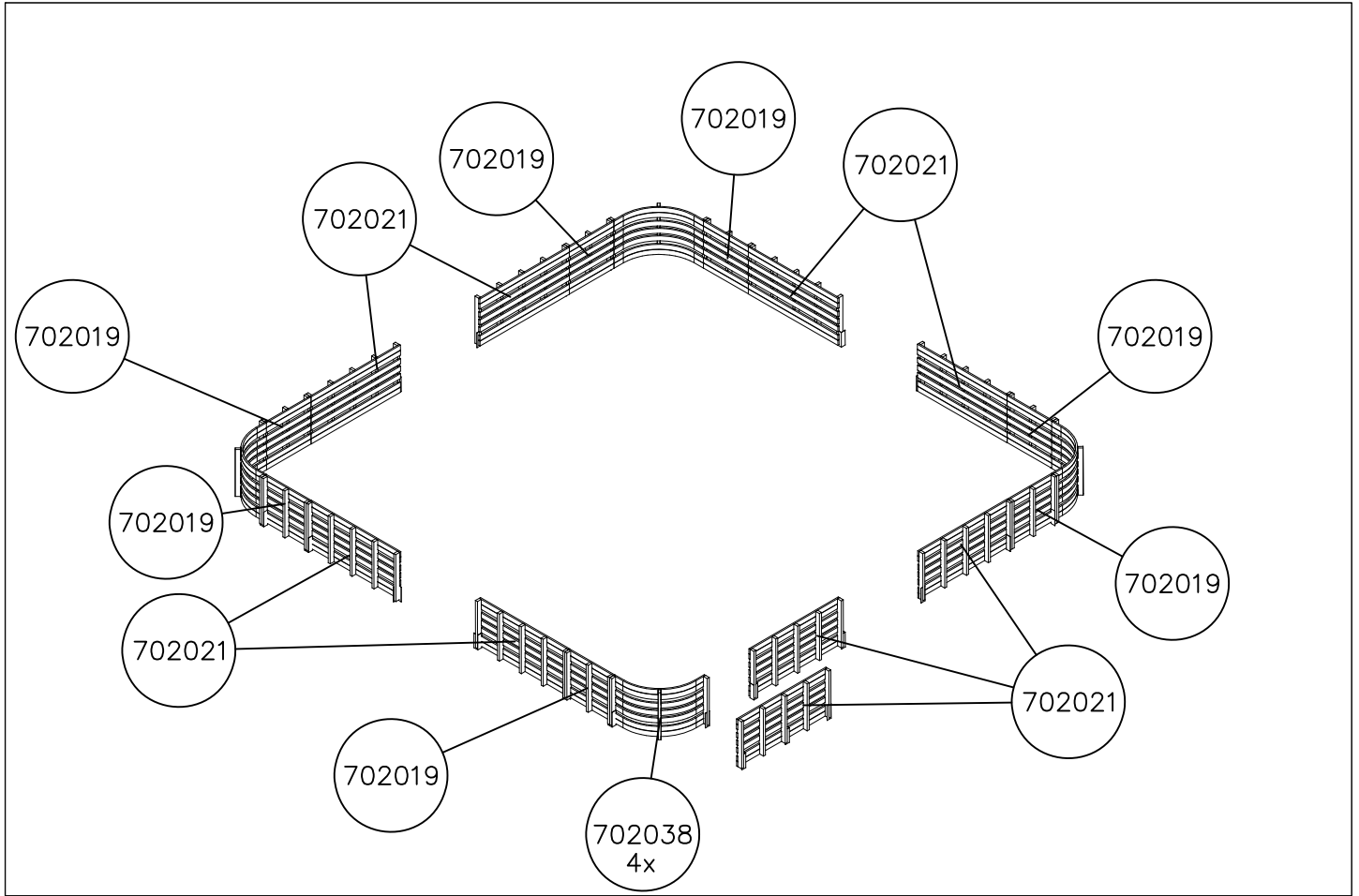

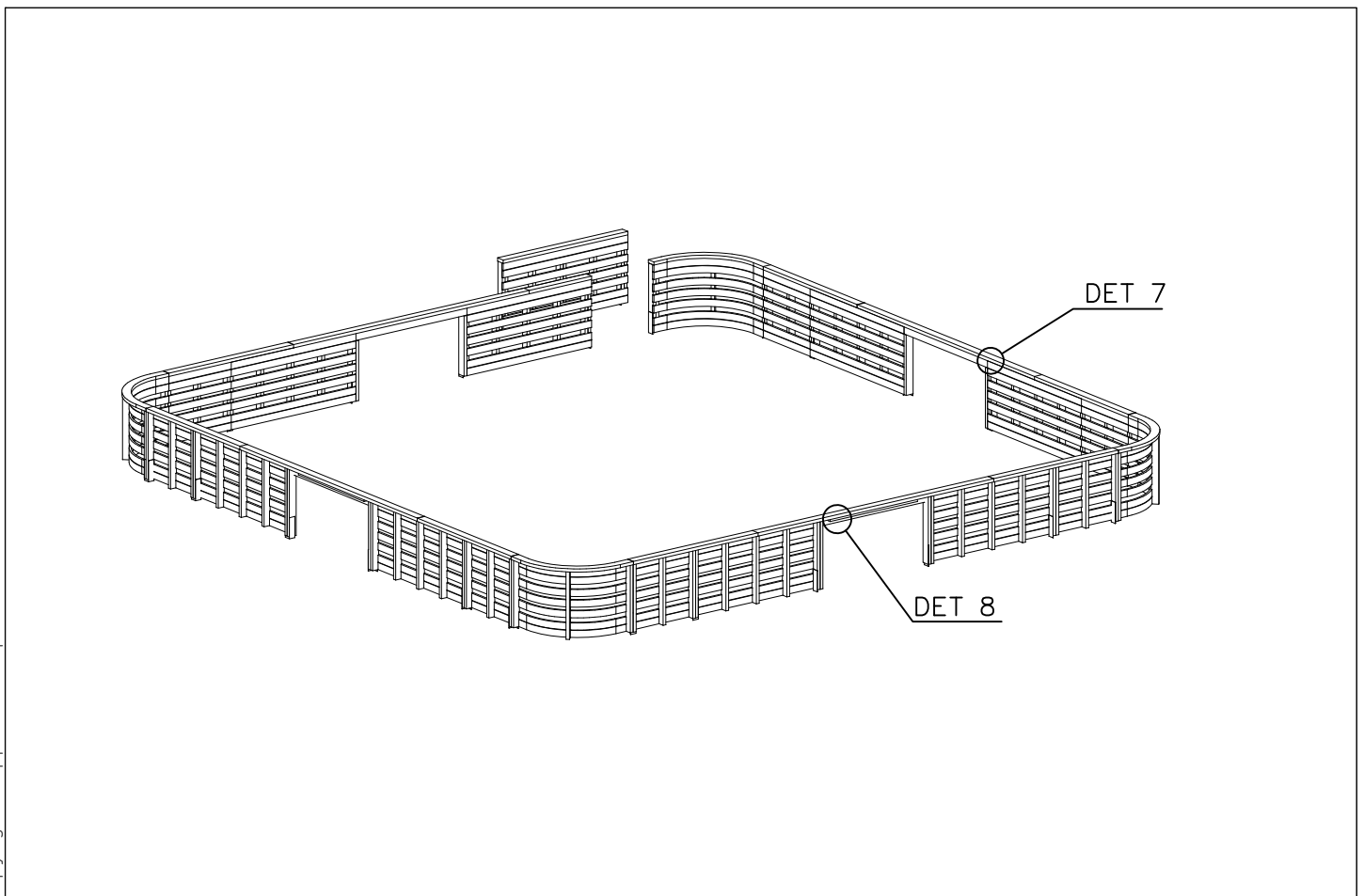
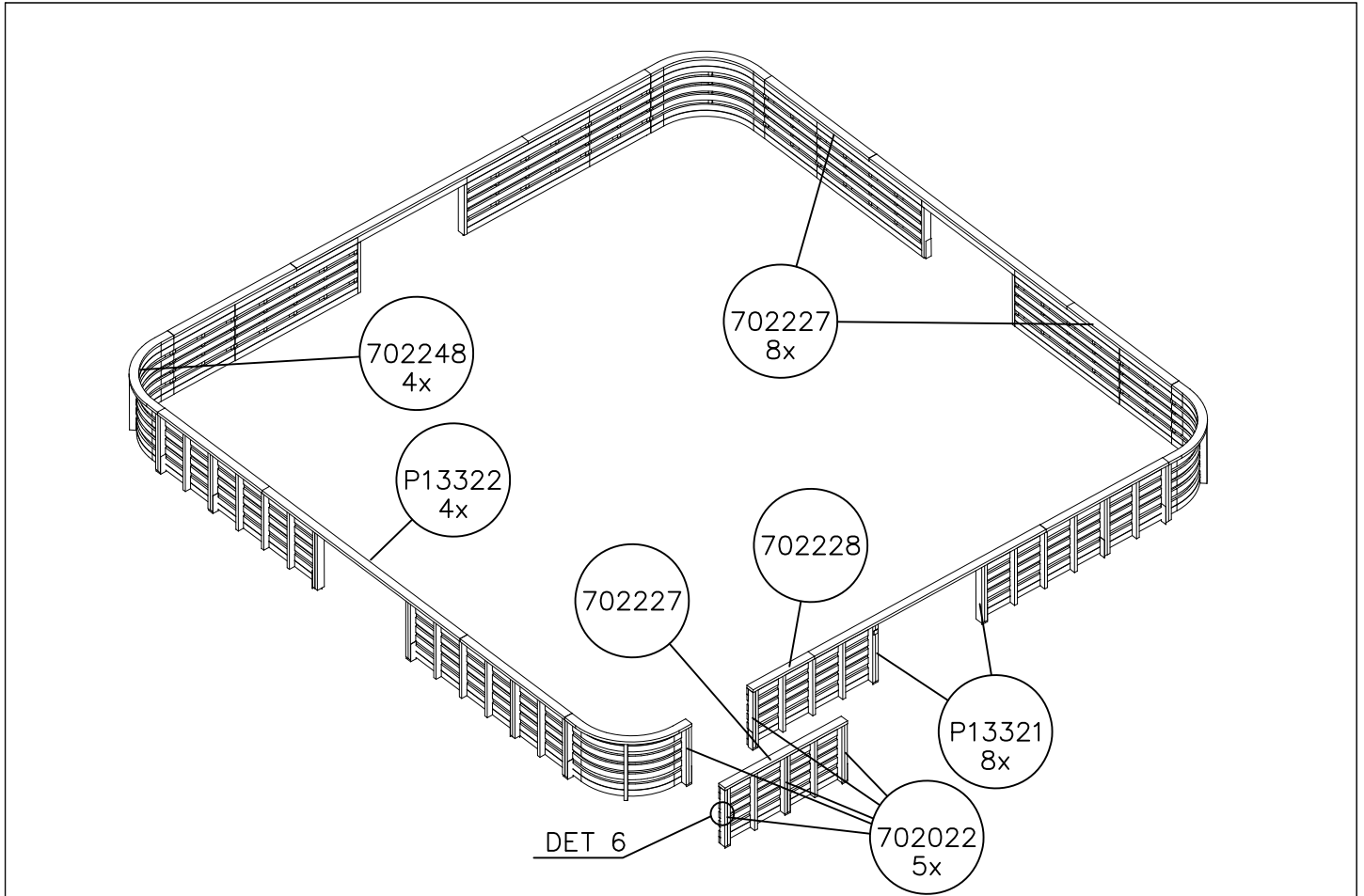

<p>DET 1</p> <p>M8 Ø24/8.4 M8x75</p>	<p>DET 2</p> <p>8x70 Inspeccion hole</p>	<p>DET 3</p> <p>902434 Ø7x40 Ø4x50 20</p>	<p>DET 4</p> <p>902434 Ø7x40 Ø4x50 20</p>
<p>DET 5</p> <p>P13321 Ø8x70 900240 Ø24/8.4 980152</p>		<p>DET 6</p> <p>702022 Ø8x70 900240 Ø24/8.4 980152</p>	
<p>DET 7</p> <p>Ø6x60 980107</p>	<p>DET 8</p> <p>Ø4.5x70 980101</p>		

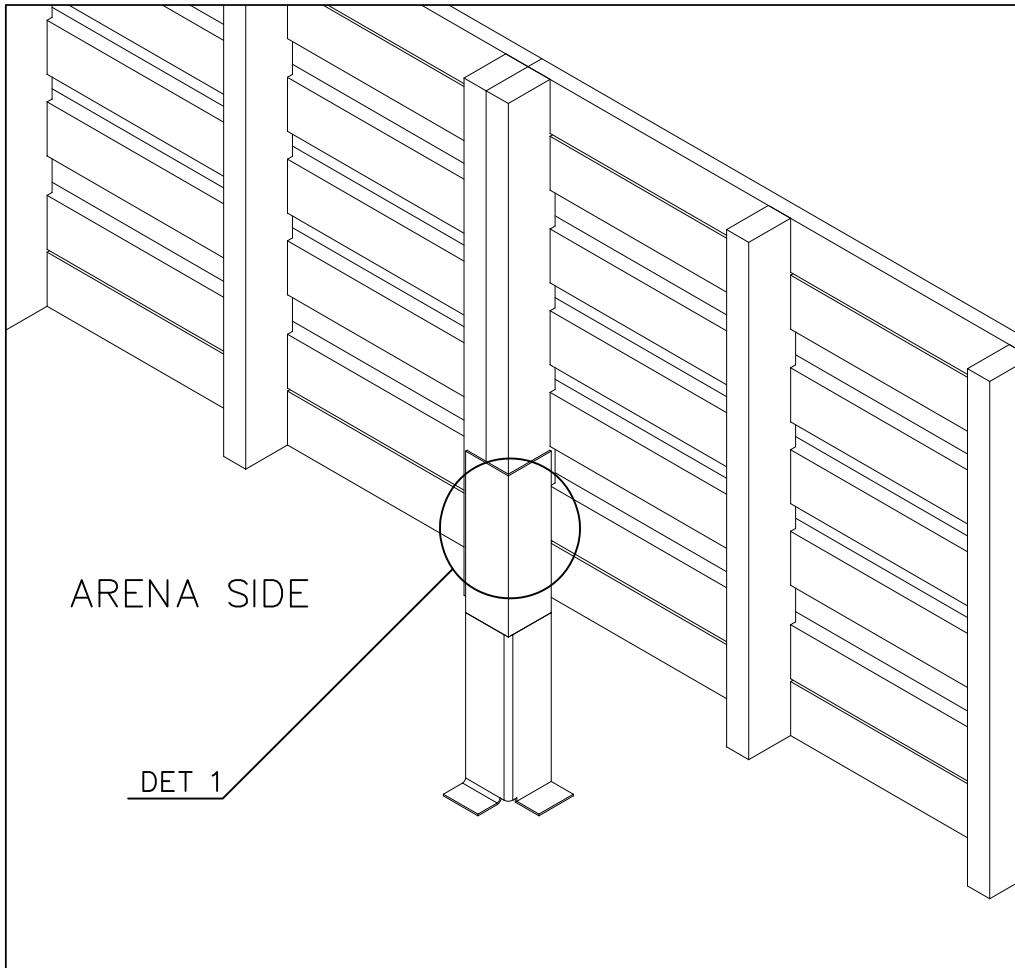

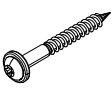

① 902433	PCS	② 900240	PCS
	1		6
		Ø8x70	
	PCS		PCS
	PCS		PCS
	PCS		PCS

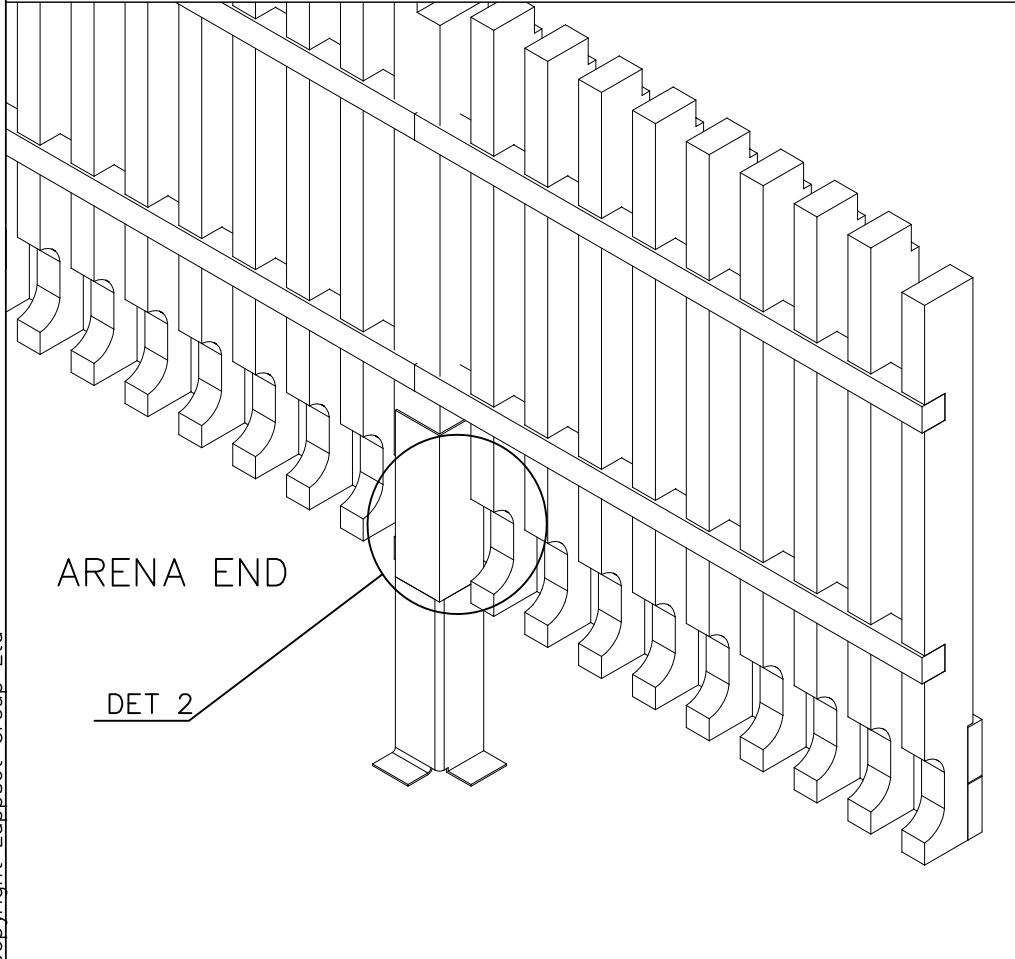

DET 1 ARENA SIDE

DET 2 ARENA END

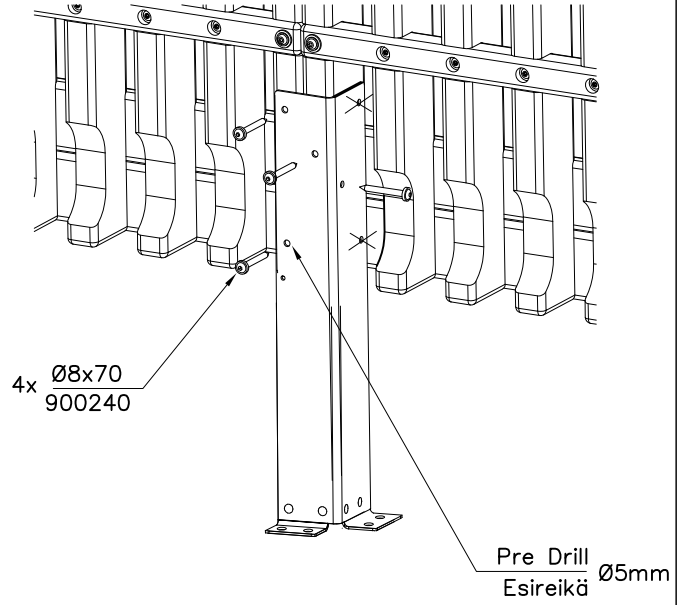
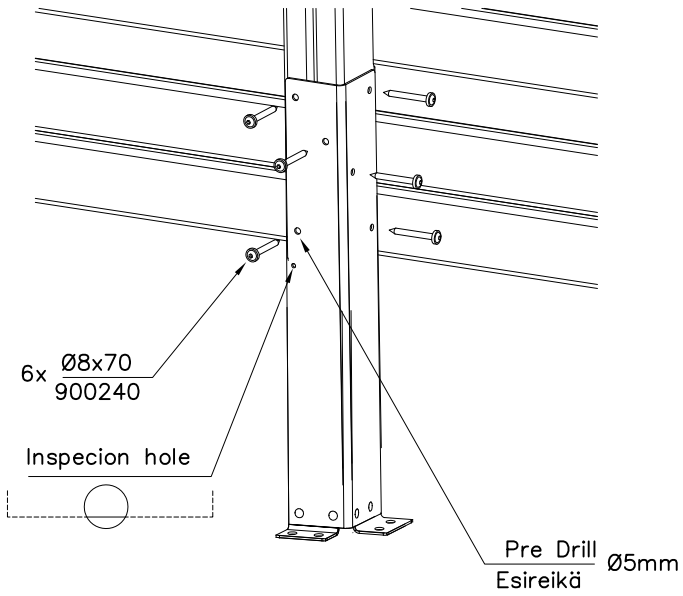

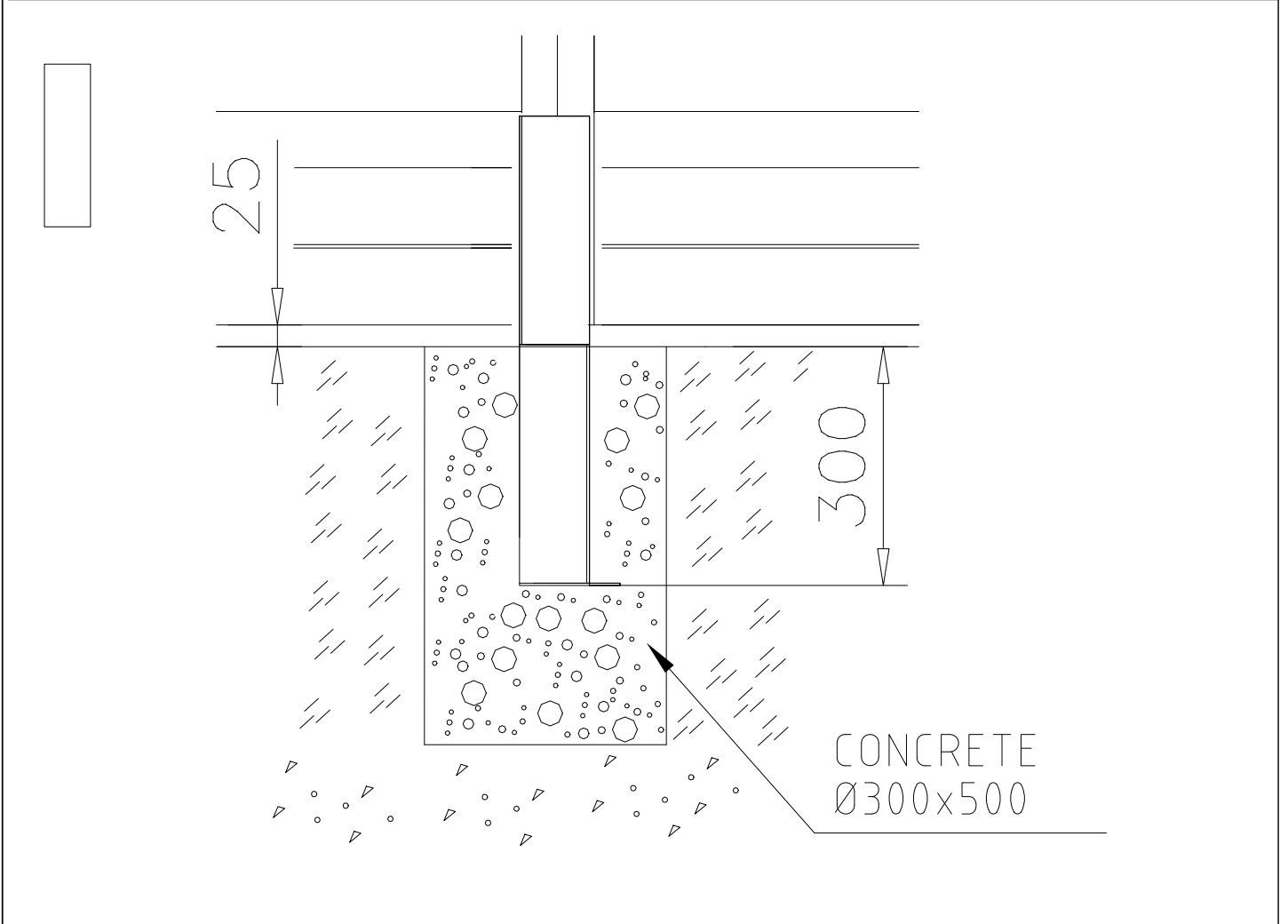
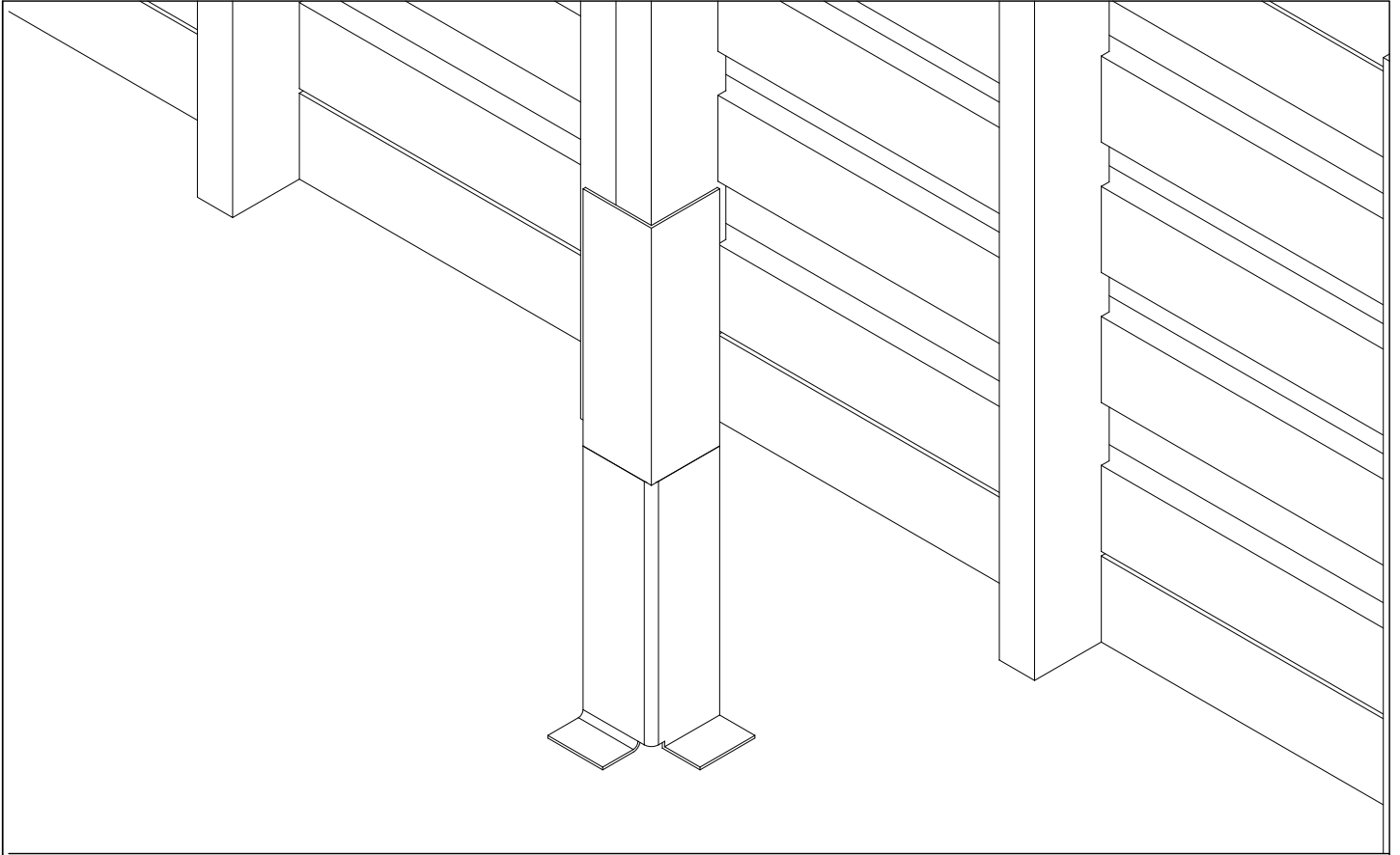

**Tuotekyltti tulee tuotteen mukana yhdellä seuraavista tavoista:****1) Metallinen tuotekyltti ja kiinnitysruuvit**

- Kiinnitä tuotekyltti ruuveilla tolppaan noin 2 metrin korkeuteen kuvan 1 mukaisesti.

2) Tuotekylttitarra

- Puhdista maalattu metalli- tai vaneripinta pölystä ja kosteudesta. Liimaa tarra kuvan 2 mukaisesti.
- Huom. Älä kiinnitä tarraa karheapintaiseen laminaattiin tai maalattuun puuhun.

Vår produktmärkning levereras på ett av följande sätt:**1) Produktskylt i metall**

- Fäst skylten med de medföljande skruvarna

2) Självhäftande produktetikett

- Rengör den pulverlackerade metallytan eller laminatyten så att den blir fri från smuts och fukt. Fäst etiketten enligt fig. 2.
- Obs! Fäst ej etiketten på detaljer med skrovlig yta eller på målat trä.

Product label is delivered by one of following ways:**1) Metal product label and screws**

- Fasten the label with screws.

2) Label sticker

- Clean the painted metal or plywood surface from dirt and moisture. Fasten the sticker as shown in the figure 2.
- Note. Do not attach the sticker to rough surfaced laminate or painted wood.

La plaque d'informations produit est livrée sous l'une de ces 3 formes :**1) Plaque métallique et vis**

- Fixez la plaque à l'aide des vis.

2) Etiquette autocollante

- Avant de coller l'étiquette, nettoyez le composant métallique peint ou la plaque de contreplaqué, de toute saleté. La surface doit être sèche (voir image 2).
- Attention, ne pas coller l'étiquette sur une surface lamellé-collée irrégulière ou sur du bois peint.

Die Auslieferung des Produktaufklebers erfolgt auf eine dieser Arten:**1) Produkt-Schild aus Metall incl. Schrauben**

- Die Befestigung des Schildes erfolgt mittels der Schrauben.

2) Aufkleber

- Entfernen Sie zunächst Schmutz und Feuchtigkeit vom lackierten Metall bzw. von der Holzoberfläche und bringen Sie den Aufkleber wie im Bild oben rechts beschrieben auf den gesäuberten Untergrund auf.
- Beachten Sie: Bringen Sie den Aufkleber nicht auf raues laminiertes oder lackiertes Holz an.