

LAPPSET®

ARENA



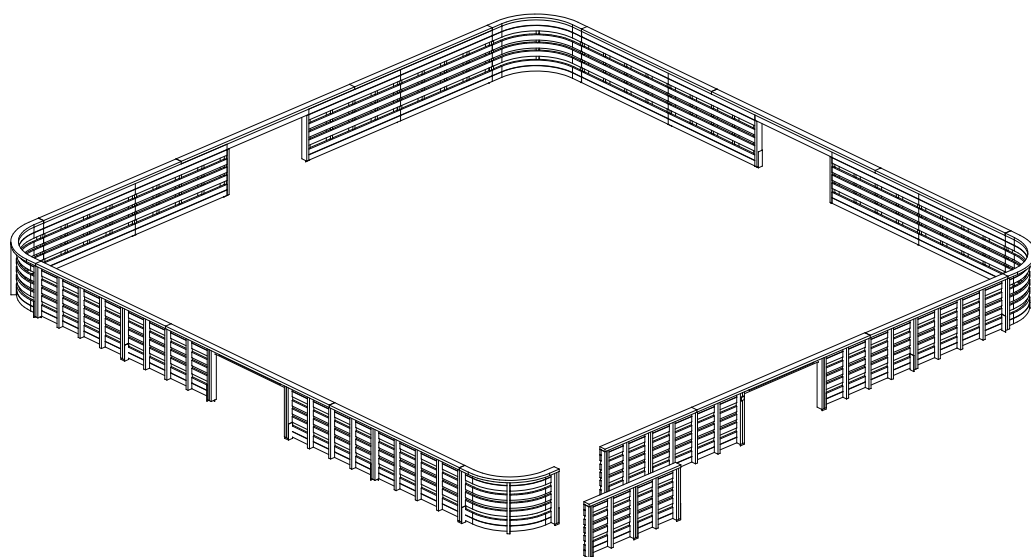

ASENNUSOHJE
MONTERINGSANSVISNING
INSTALLATION INSTRUCTION
AUFBAUANLEITUNG
NOTICE D'INSTALLATION

DATE: 23.2.2021

Q13756-1

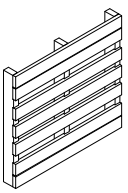
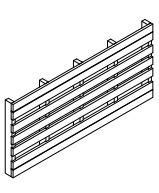
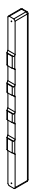
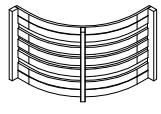
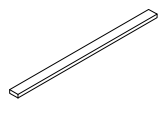
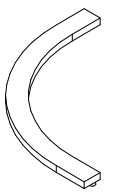
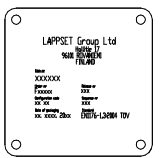
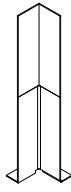
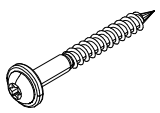
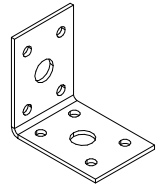
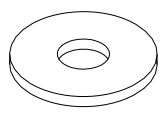

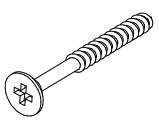
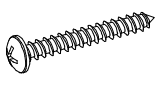
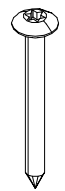
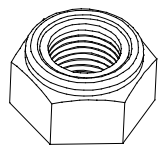
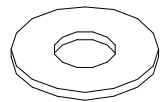
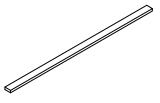
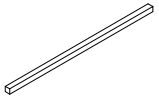
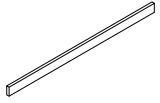
DATE: 23.2.2021

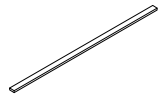
<p>702019</p>  <p>L 1000</p>	<p>PCS</p> <p>1</p>	<p>702021</p>  <p>L 2000</p>	<p>PCS</p> <p>16</p>	<p>702022</p>  <p>L 910</p>	<p>PCS</p> <p>5</p>	<p>702038</p> 	<p>PCS</p> <p>4</p>	<p>702227</p>  <p>L 2000</p>	<p>PCS</p> <p>2</p>	<p>702248</p> 	<p>PCS</p> <p>4</p>
<p>702286</p>  <p>65x65</p>	<p>PCS</p> <p>1</p>	<p>708383</p> 	<p>PCS</p> <p>28</p>	<p>900240</p>  <p>Ø8x70</p>	<p>PCS</p> <p>39</p>	<p>902434</p> 	<p>PCS</p> <p>66</p>	<p>905051</p>  <p>Ø24/8.4</p>	<p>PCS</p> <p>150</p>	<p>909203</p>  <p>M8x75</p>	<p>PCS</p> <p>75</p>
<p>980101</p>  <p>Ø4.5x70</p>	<p>PCS</p> <p>16</p>	<p>980107</p>  <p>Ø6x60</p>	<p>PCS</p> <p>168</p>	<p>980114</p>  <p>Ø4x20</p>	<p>PCS</p> <p>4</p>	<p>980128</p>  <p>Ø7x40</p>	<p>PCS</p> <p>132</p>	<p>980150</p>  <p>M8</p>	<p>PCS</p> <p>75</p>	<p>980152</p>  <p>Ø24/8.4</p>	<p>PCS</p> <p>39</p>
<p>P01444</p>  <p>L 3000</p>	<p>PCS</p> <p>7</p>	<p>P07684</p>  <p>45x45x1400</p>	<p>PCS</p> <p>4</p>	<p>P13320</p>  <p>L 1780</p>	<p>PCS</p> <p>4</p>	<p>P13321</p>  <p>L 910</p>	<p>PCS</p> <p>8</p>	<p>P13322</p>  <p>L 3780</p>	<p>PCS</p> <p>4</p>		<p>PCS</p>
	<p>PCS</p>		<p>PCS</p>		<p>PCS</p>		<p>PCS</p>		<p>PCS</p>		<p>PCS</p>
	<p>PCS</p>		<p>PCS</p>		<p>PCS</p>		<p>PCS</p>		<p>PCS</p>		<p>PCS</p>

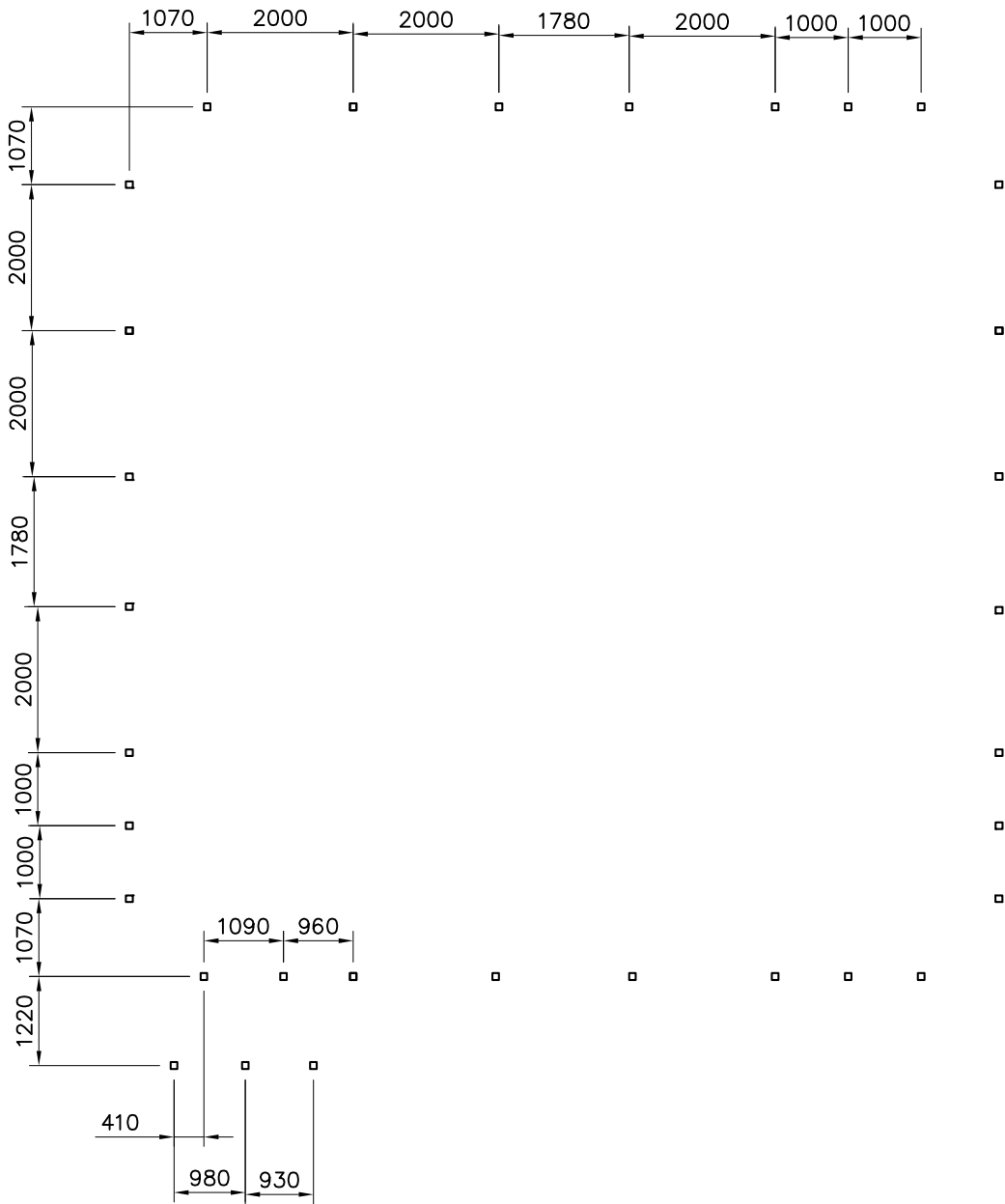
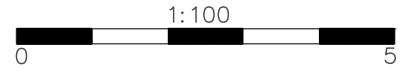

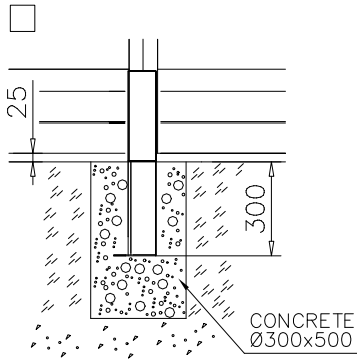

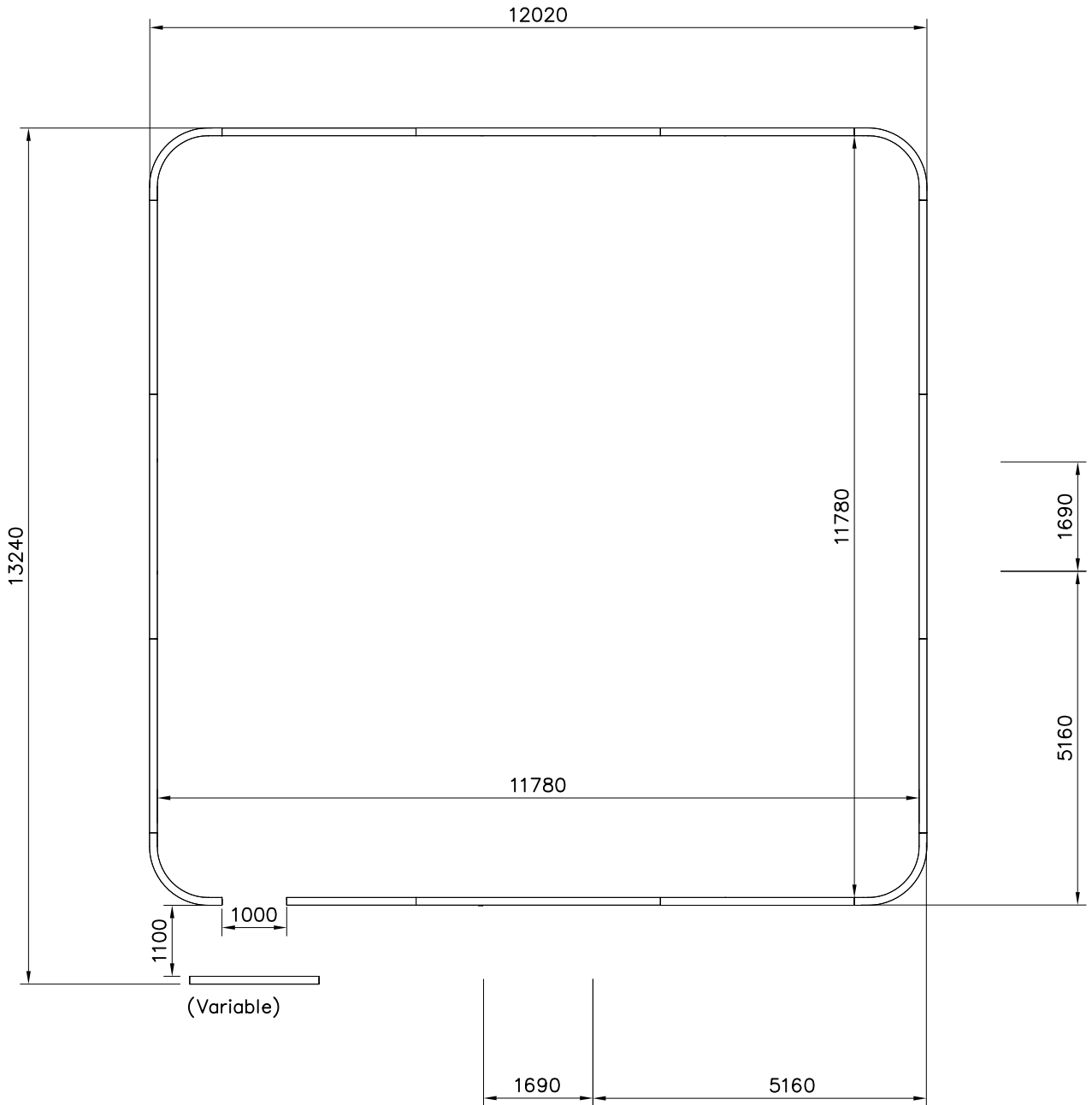
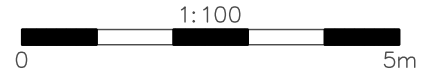

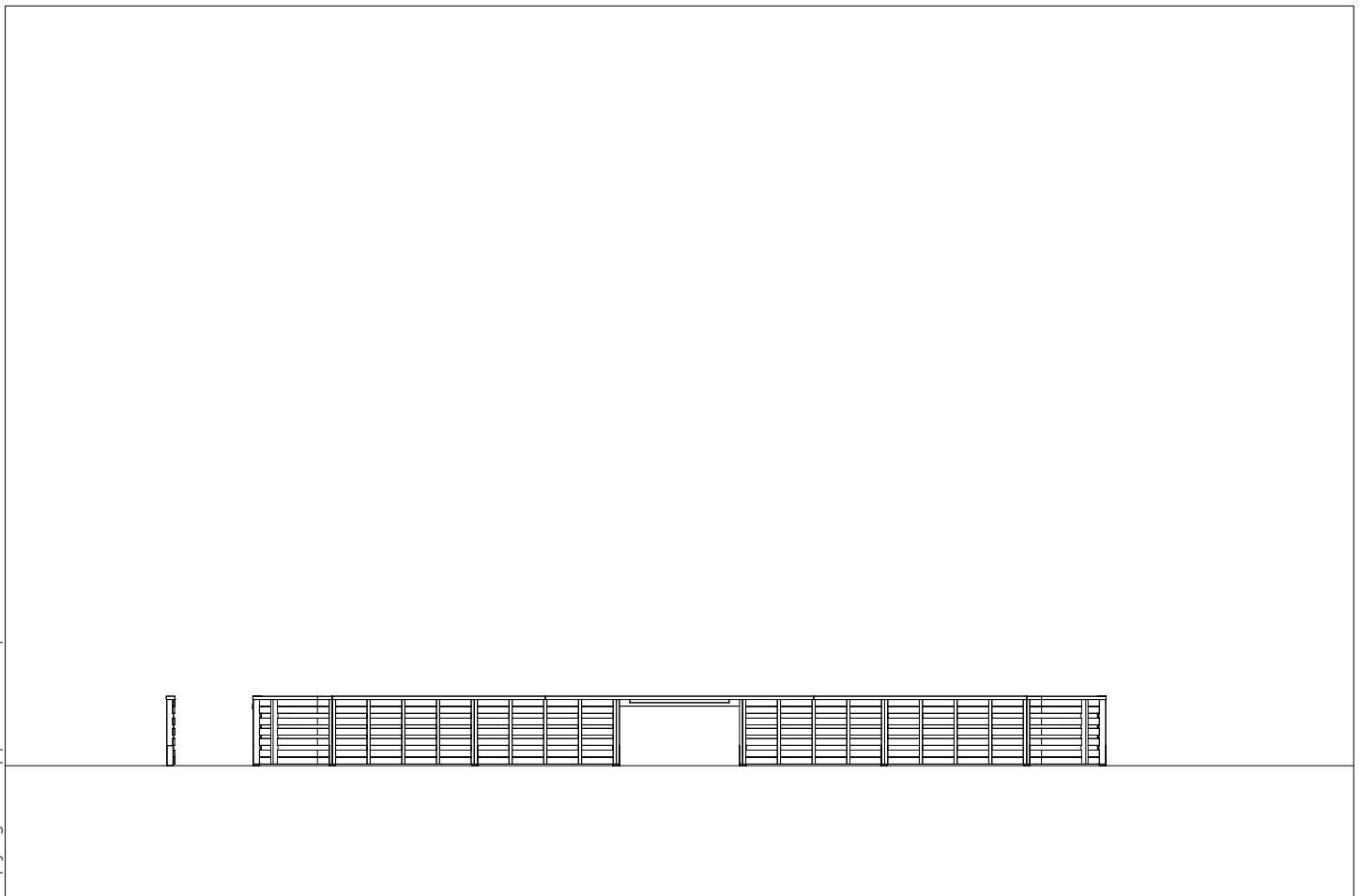
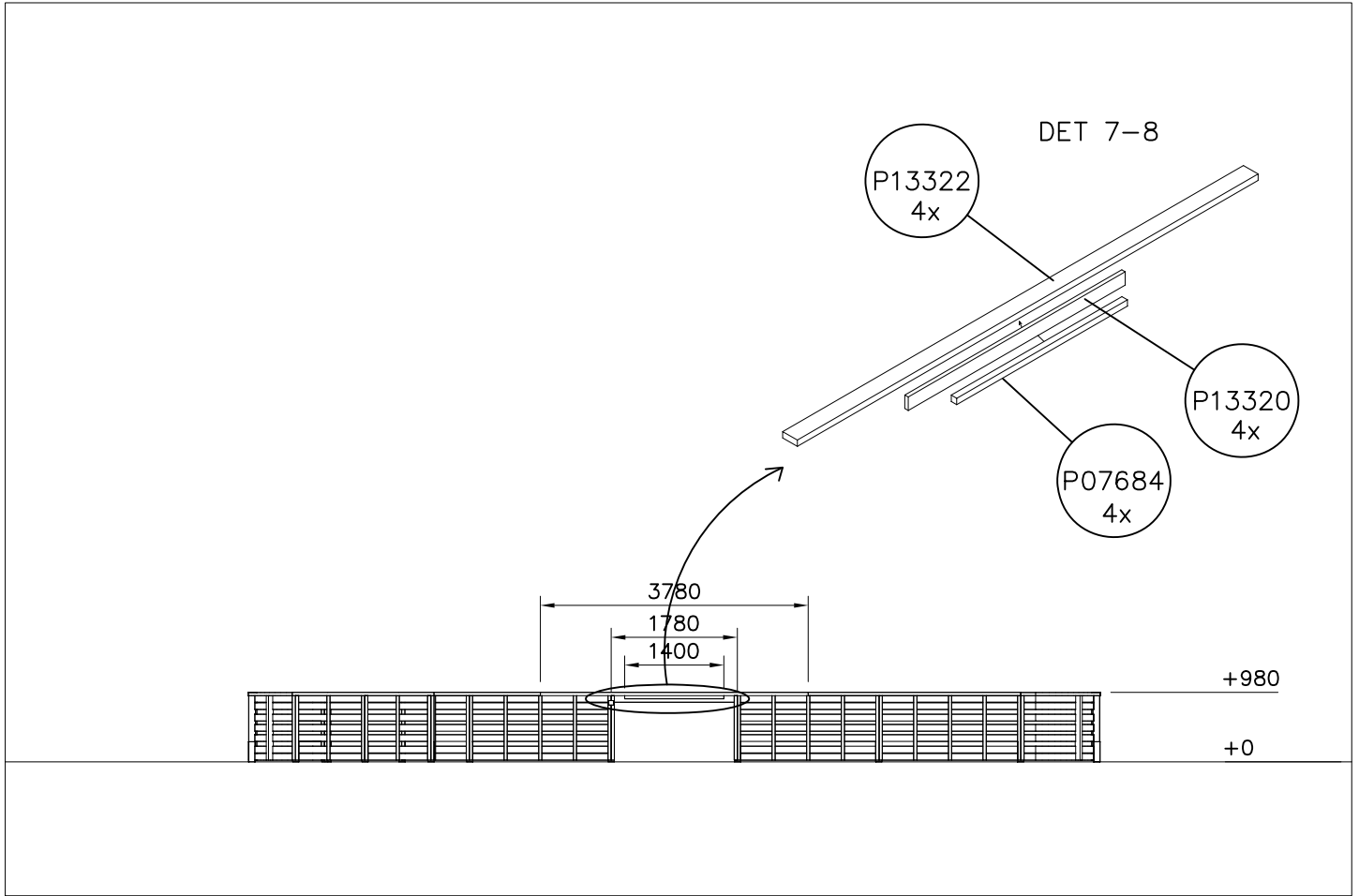

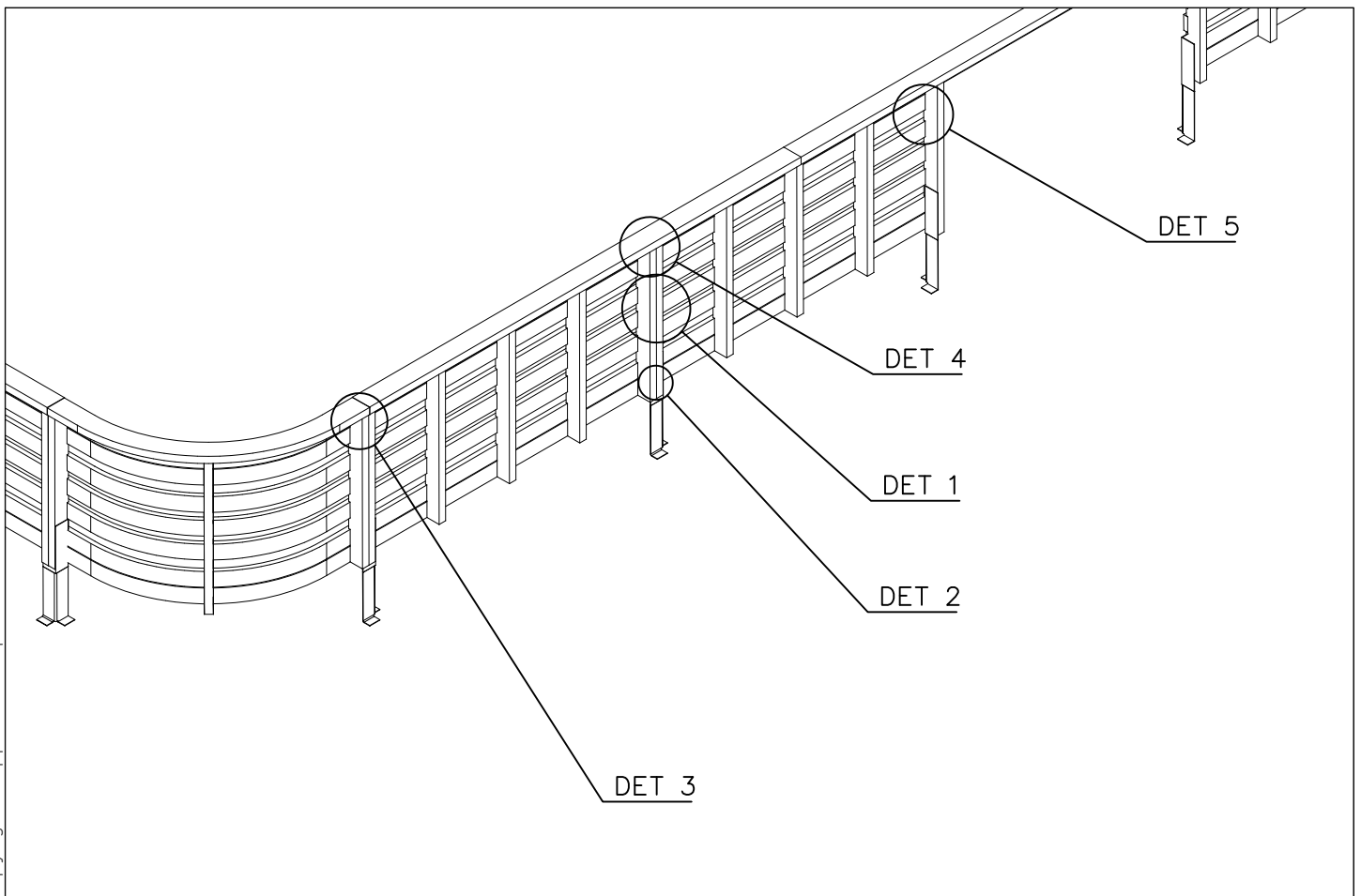
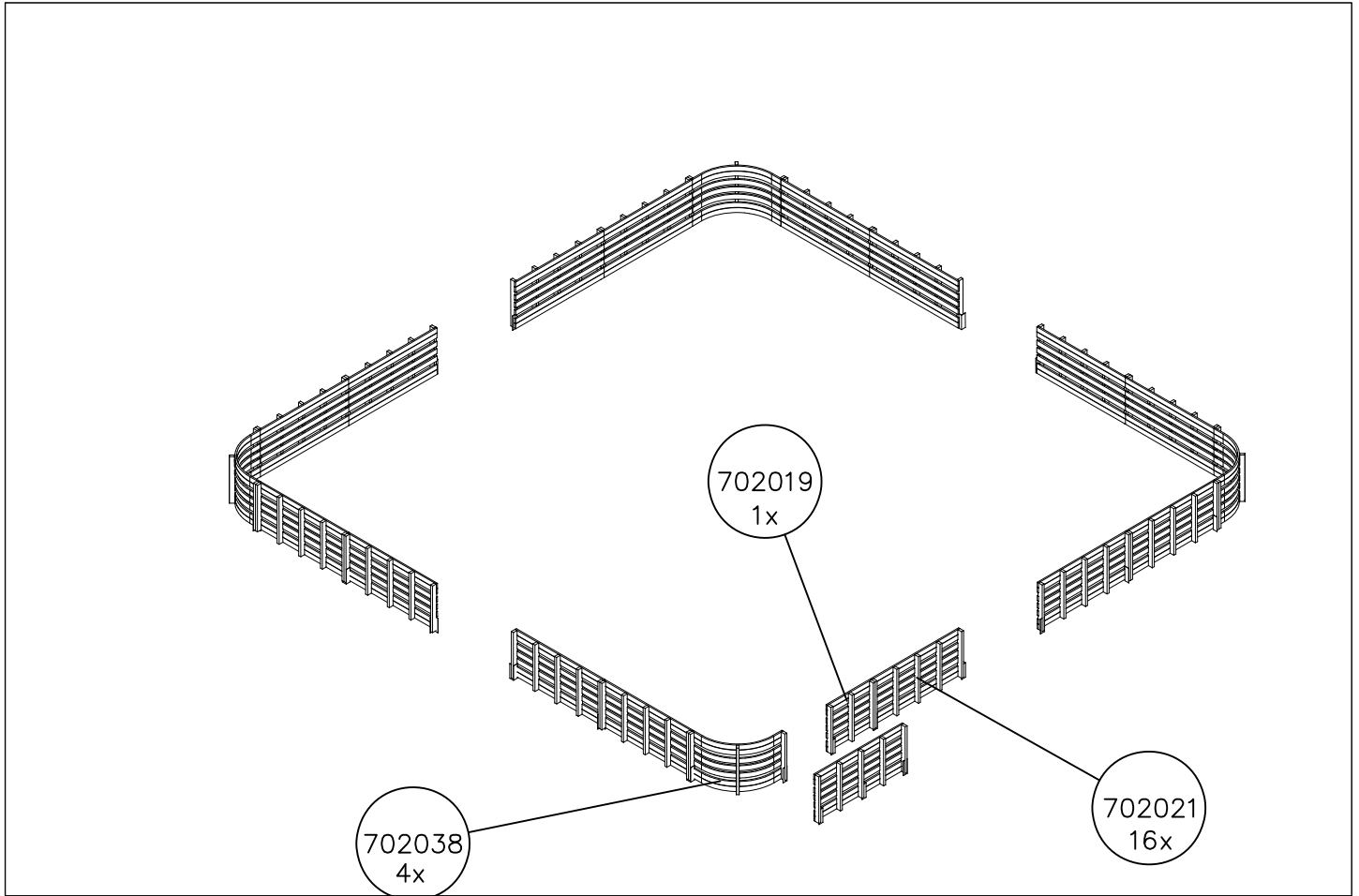

<p>DET 1</p> <p>M8 Ø24/8.4 M8x75</p>	<p>DET 2</p> <p>8x70 Inspeccion hole</p>	<p>DET 3</p> <p>902434 Ø7x40 Ø4x50 20</p>	<p>DET 4</p> <p>902434 Ø7x40 Ø4x50 20</p>
<p>DET 5</p> <p>Ø8x70 900240 Ø24/8.4 980152</p>	<p>DET 6</p> <p>702022 Ø8x70 900240 Ø24/8.4 980152</p>		
<p>DET 7</p> <p>Ø6x60 980107</p>	<p>DET 8</p> <p>Ø4.5x70 980101</p>		

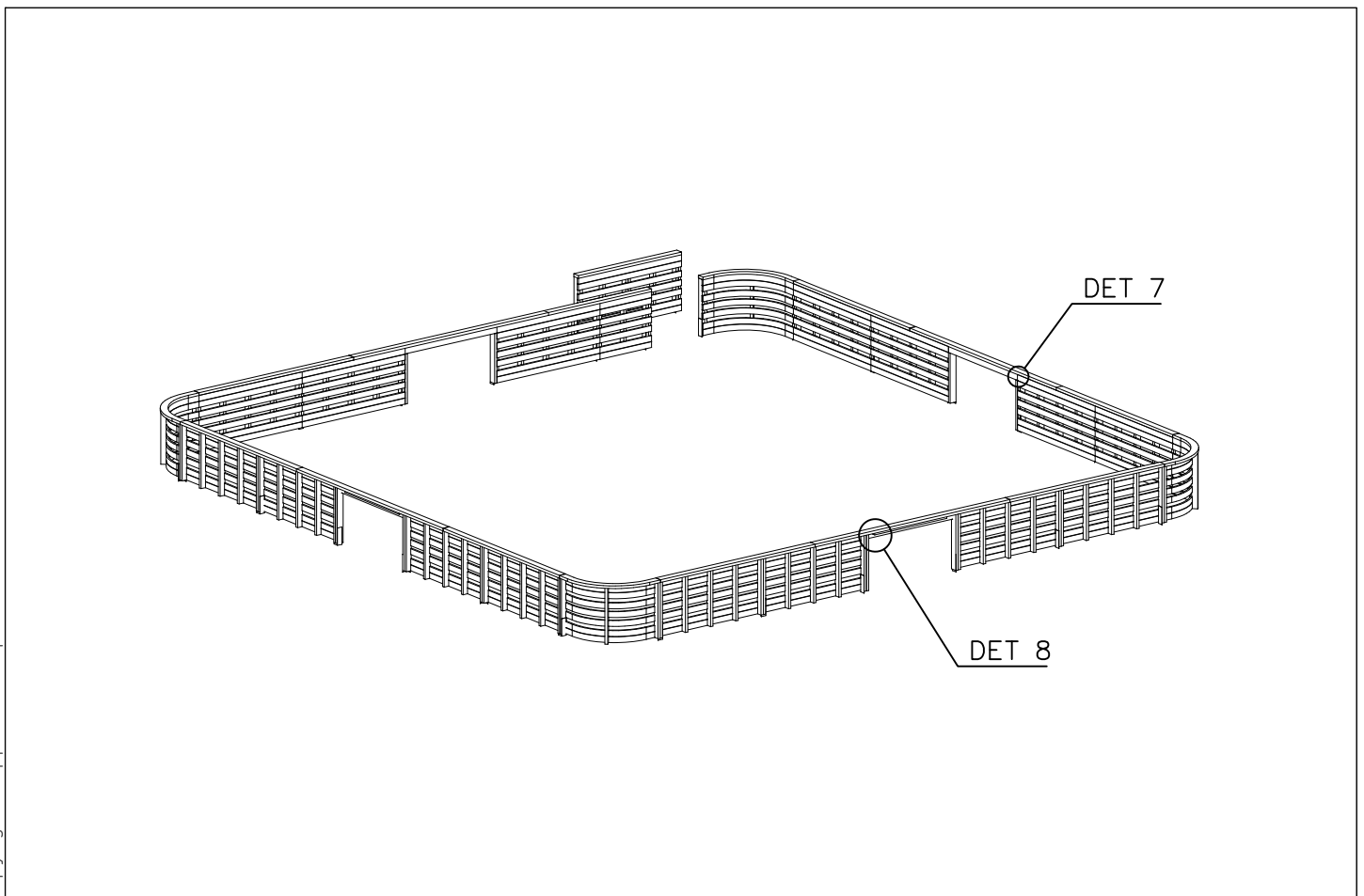
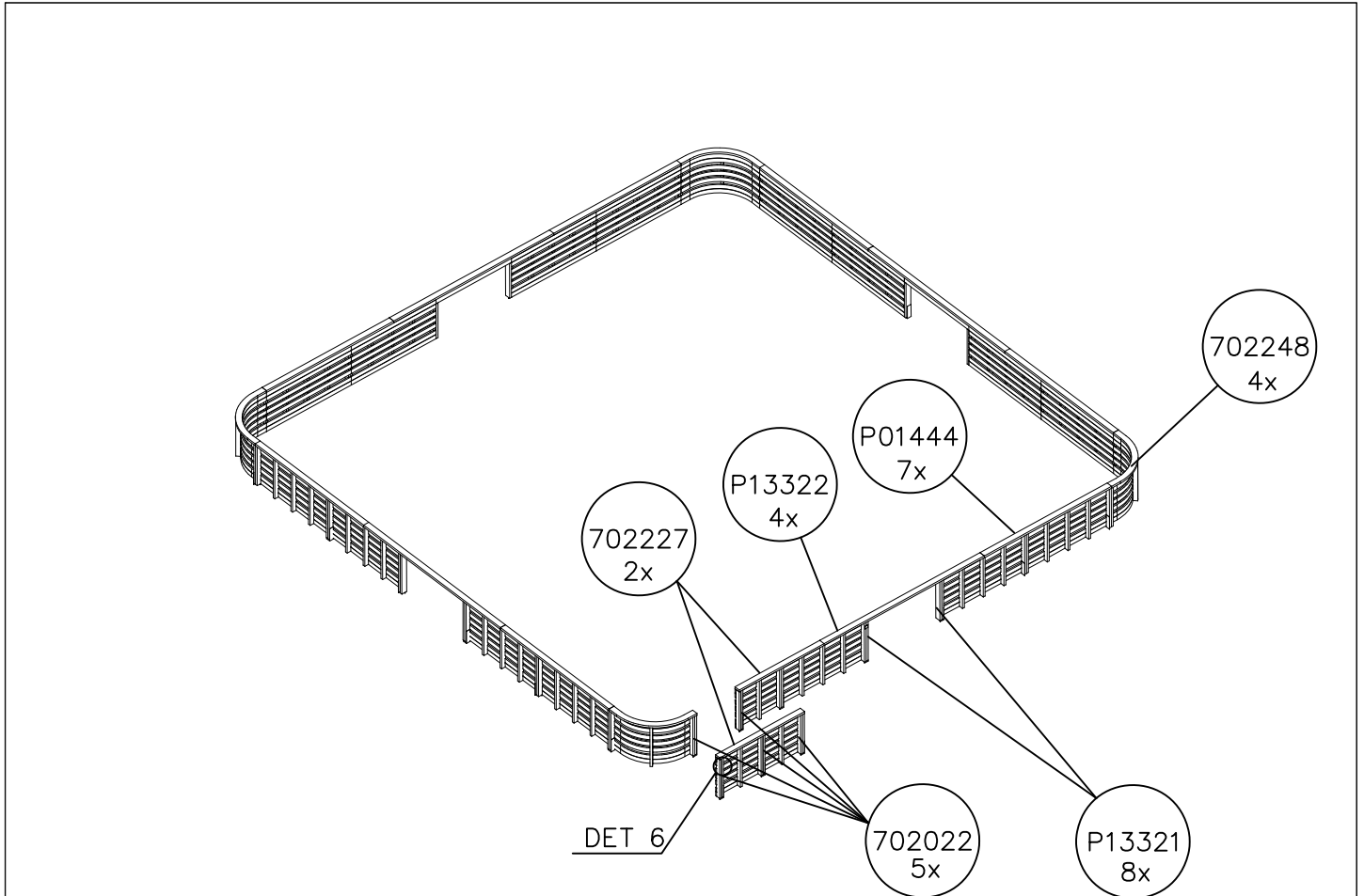

**Tuotekyltti tulee tuotteen mukana yhdellä seuraavista tavoista:****1) Metallinen tuotekyltti ja kiinnitysruuvit**

- Kiinnitä tuotekyltti ruuveilla tolppaan noin 2 metrin korkeuteen kuvan 1 mukaisesti.

2) Tuotekylttitarra

- Puhdista maalattu metalli- tai vaneripinta pölystä ja kosteudesta. Liimaa tarra kuvan 2 mukaisesti.
- Huom. Älä kiinnitä tarraa karheapintaiseen laminaattiin tai maalattuun puuhun.

Vår produktmärkning levereras på ett av följande sätt:**1) Produktskylt i metall**

- Fäst skylten med de medföljande skruvarna

2) Självhäftande produktetikett

- Rengör den pulverlackerade metallytan eller laminatyten så att den blir fri från smuts och fukt. Fäst etiketten enligt fig. 2.
- Obs! Fäst ej etiketten på detaljer med skrovlig yta eller på målat trä.

Product label is delivered by one of following ways:**1) Metal product label and screws**

- Fasten the label with screws.

2) Label sticker

- Clean the painted metal or plywood surface from dirt and moisture. Fasten the sticker as shown in the figure 2.
- Note. Do not attach the sticker to rough surfaced laminate or painted wood.

La plaque d'informations produit est livrée sous l'une de ces 3 formes :**1) Plaque métallique et vis**

- Fixez la plaque à l'aide des vis.

2) Etiquette autocollante

- Avant de coller l'étiquette, nettoyez le composant métallique peint ou la plaque de contreplaqué, de toute saleté. La surface doit être sèche (voir image 2).
- Attention, ne pas coller l'étiquette sur une surface lamellé-collée irrégulière ou sur du bois peint.

Die Auslieferung des Produktaufklebers erfolgt auf eine dieser Arten:**1) Produkt-Schild aus Metall incl. Schrauben**

- Die Befestigung des Schildes erfolgt mittels der Schrauben.

2) Aufkleber

- Entfernen Sie zunächst Schmutz und Feuchtigkeit vom lackierten Metall bzw. von der Holzoberfläche und bringen Sie den Aufkleber wie im Bild oben rechts beschrieben auf den gesäuberten Untergrund auf.
- Beachten Sie: Bringen Sie den Aufkleber nicht auf raues laminiertes oder lackiertes Holz an.

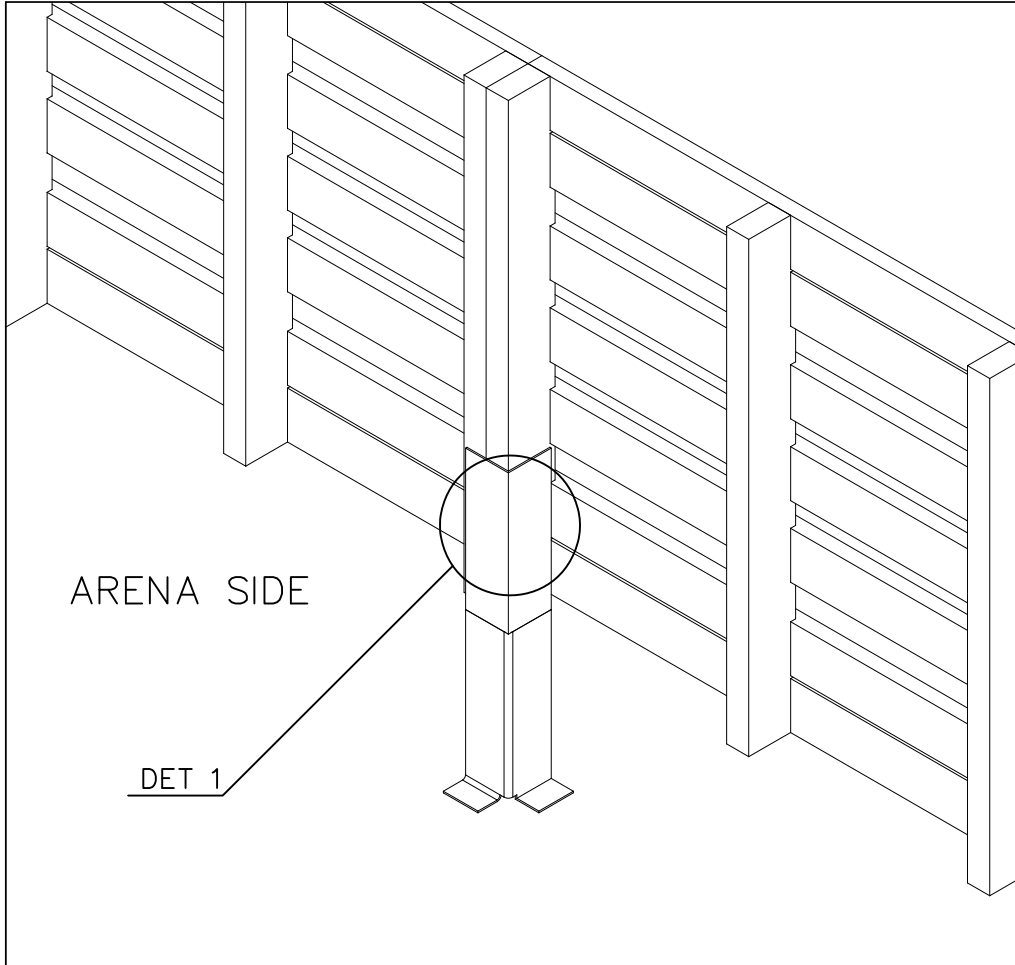

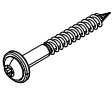
① 902433	PCS	② 900240	PCS
	1		6
		Ø8x70	
	PCS		PCS
	PCS		PCS
	PCS		PCS

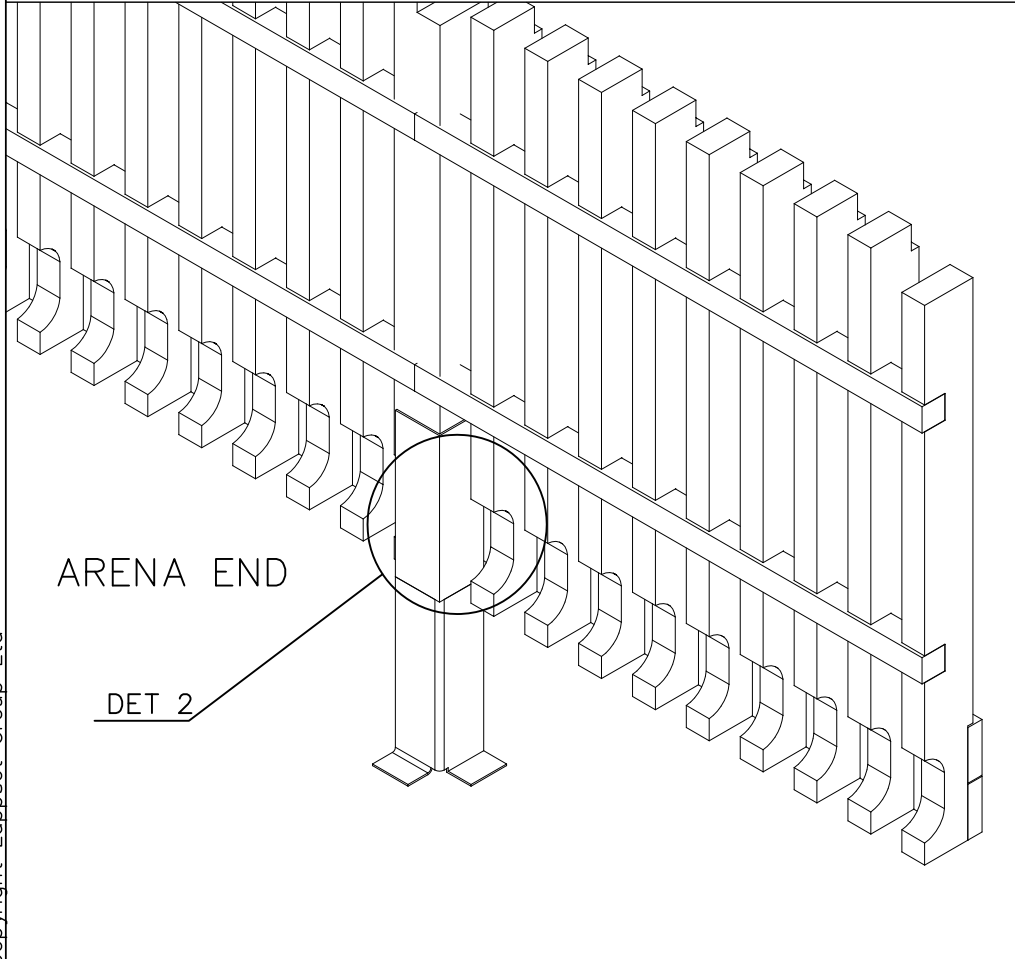

DET 1 ARENA SIDE

DET 2 ARENA END

