

# LAPPSET®

## FLORA







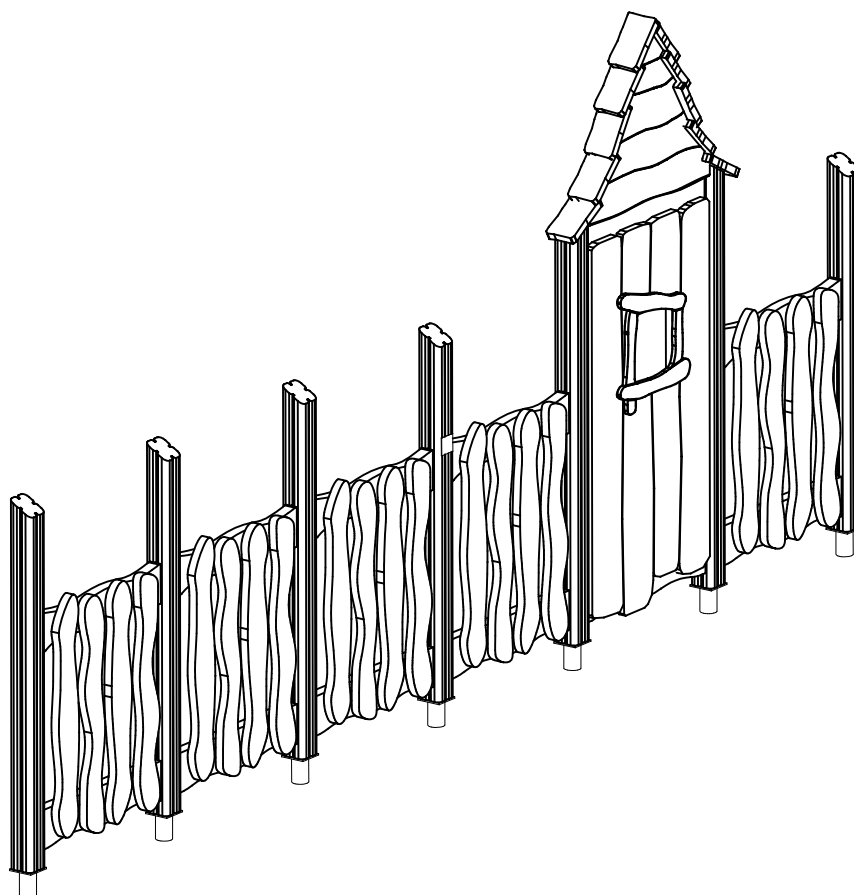

ASENNUSOHJE  
MONTERINGSANSVISNING  
INSTALLATION INSTRUCTION  
AUFBAUANLEITUNG  
NOTICE D'INSTALLATION

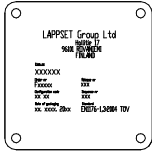
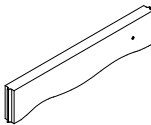
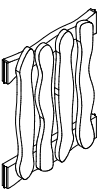
DATE: 26.6.2019

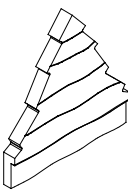
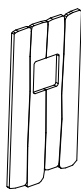
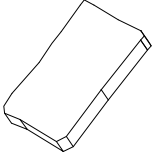
### Q13972

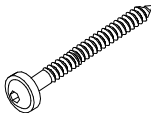
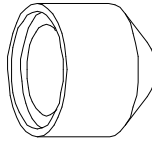
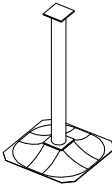

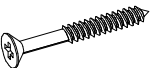
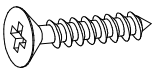
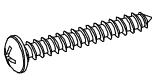
DATE: 26.6.2019

702286  65x65	PCS 1	705211  L=724	PCS 1	705230  	PCS 5	708374  68x690x704	PCS 1	708407 	PCS 1	708470  28x120x200	PCS 10
708474 	PCS 1	903093  Ø8x90	PCS 8	905104  M10	PCS 28	909521  	PCS 7	980100  Ø5x60	PCS 28	980110  Ø4x35	PCS 4
980114  Ø4x20	PCS 4	P07526  L=1546	PCS 2	P07837  L=1346	PCS 5		PCS		PCS		PCS
	PCS		PCS		PCS		PCS		PCS		PCS
	PCS		PCS		PCS		PCS		PCS		PCS
	PCS		PCS		PCS		PCS		PCS		PCS
	PCS		PCS		PCS		PCS		PCS		PCS

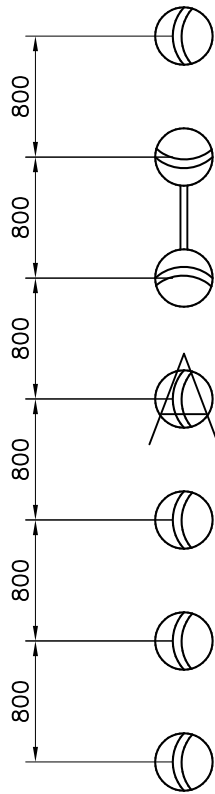

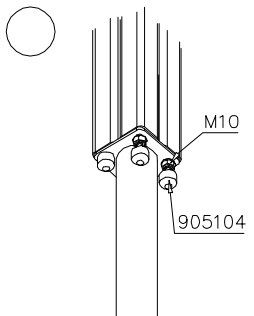
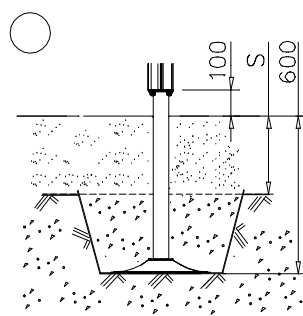
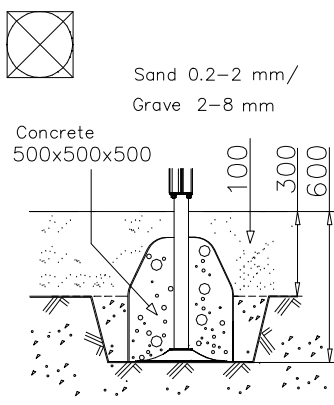
		 <p>Sand 0.2–2 mm/ Grave 2–8 mm</p> <p>Concrete 500x500x500</p>

- EN/AS Impact Area 0 m<sup>2</sup>
- - - - Falling Space 0 m<sup>2</sup>  
Max Falling Height 0000 mm

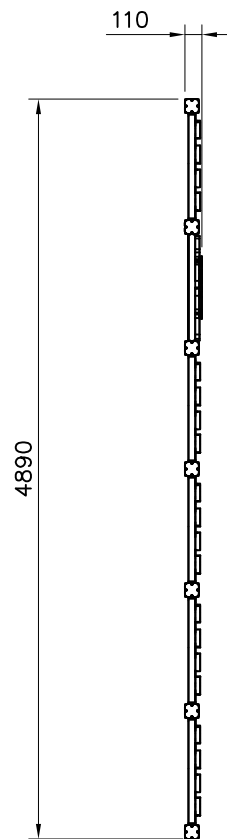
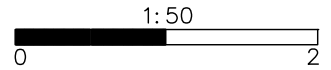

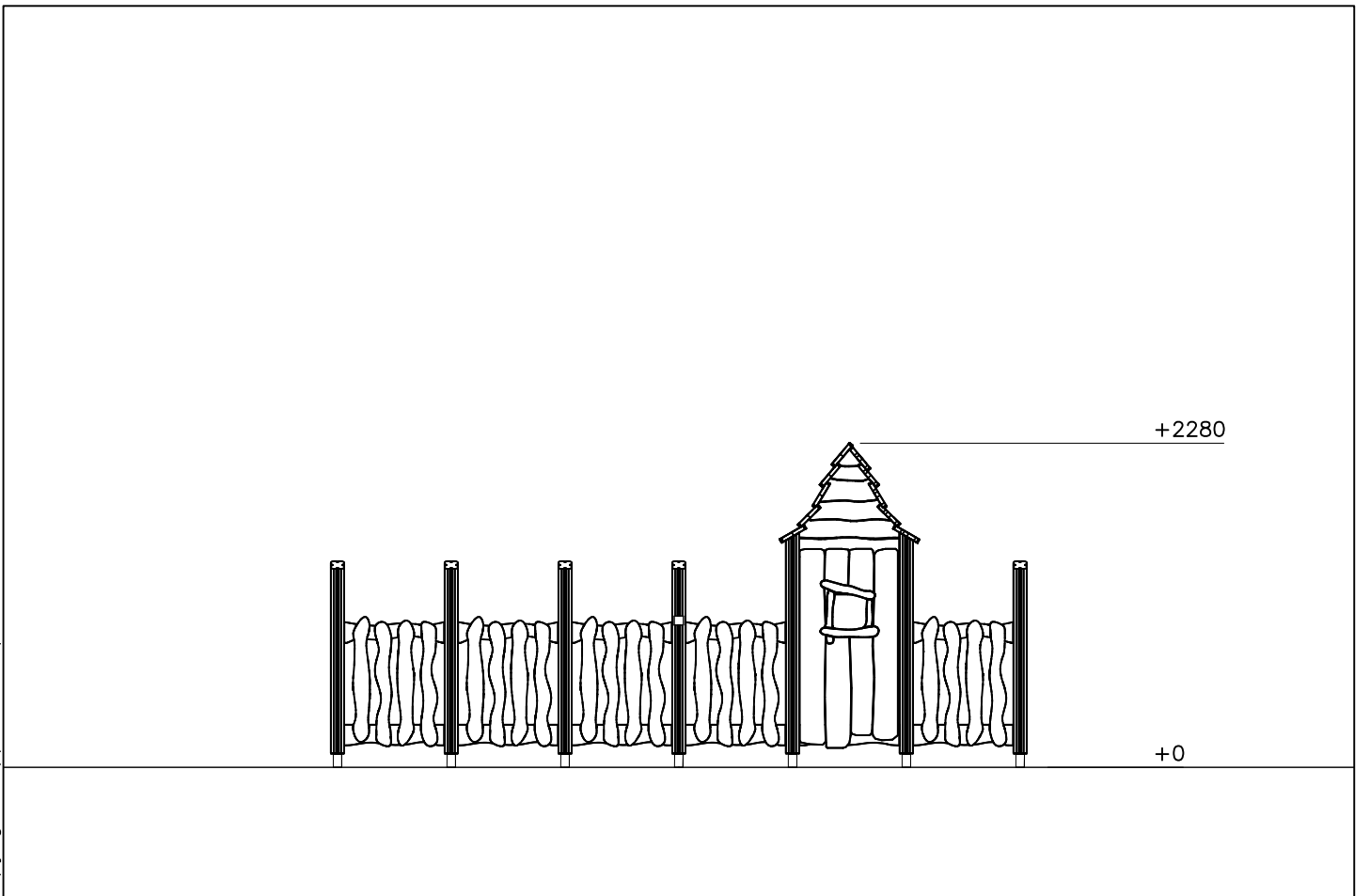
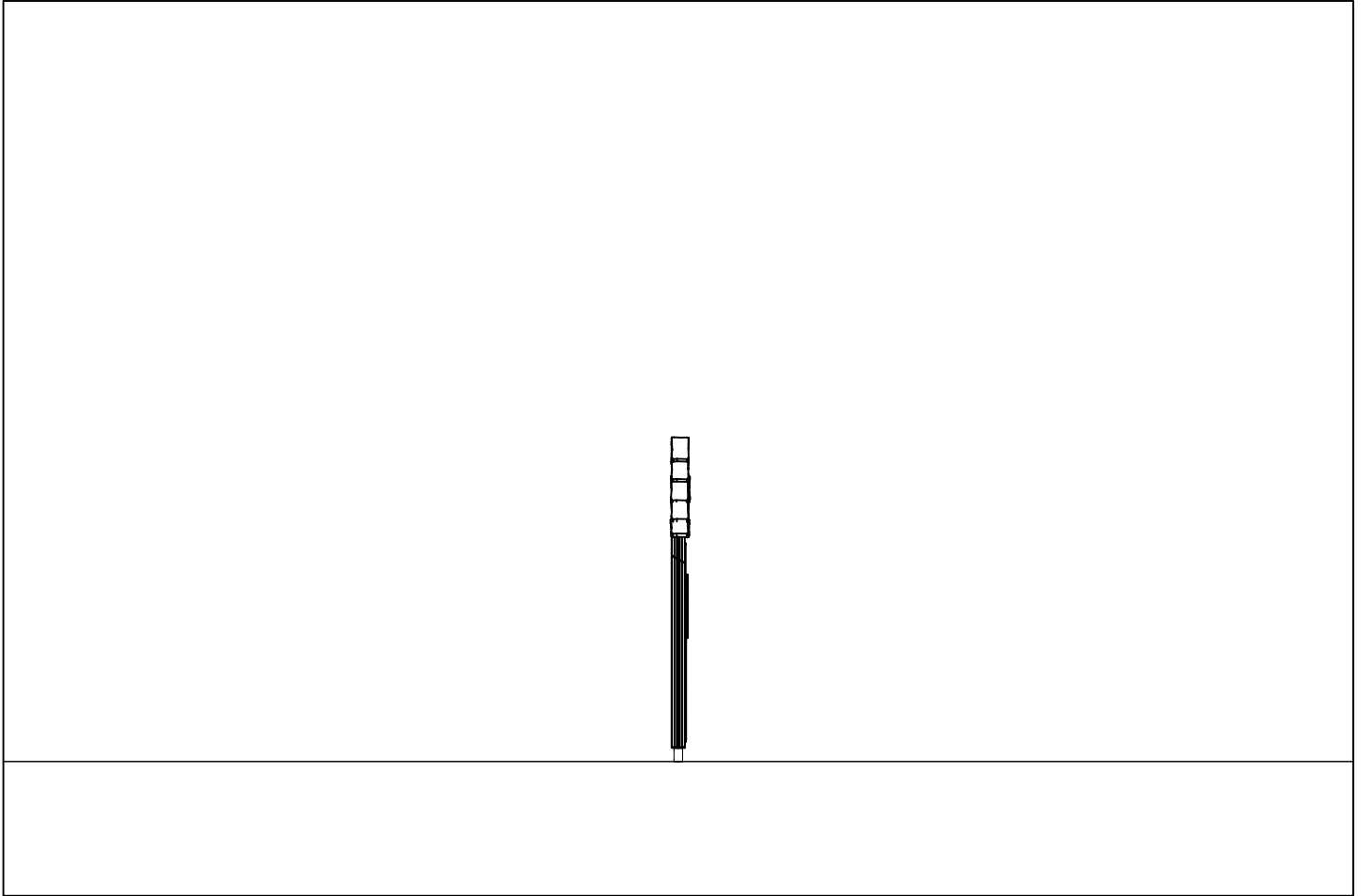

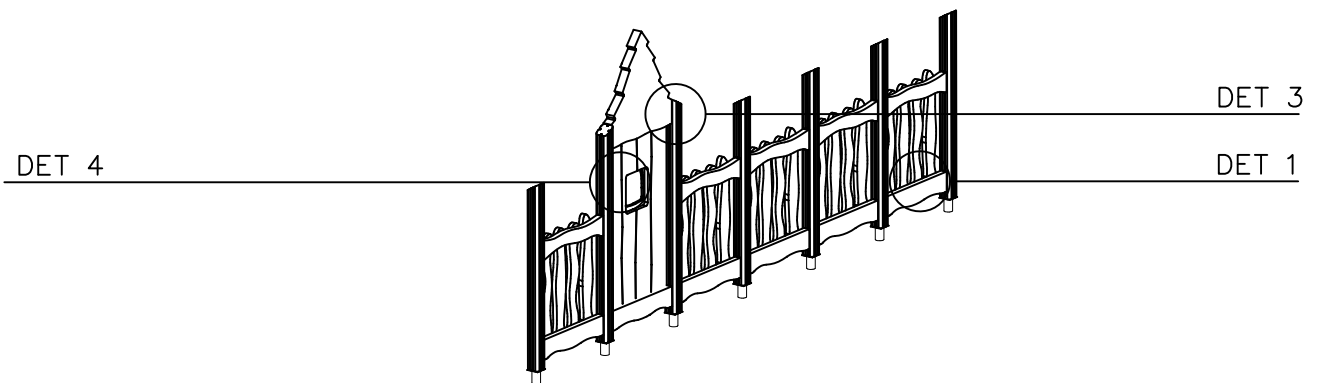
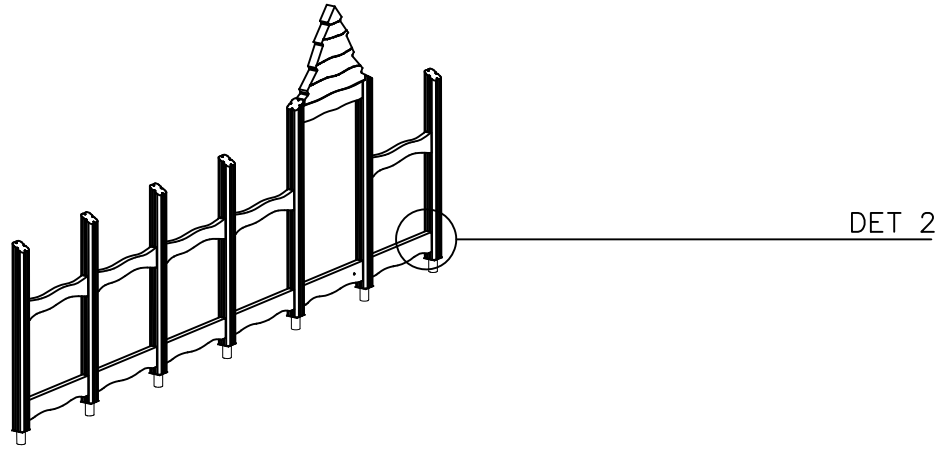

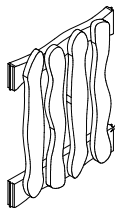
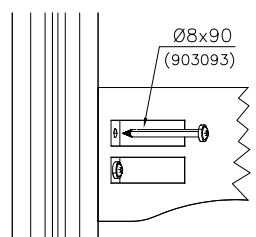
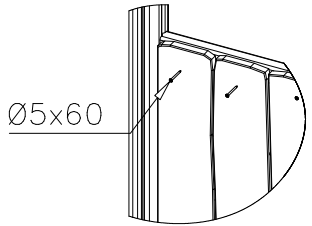
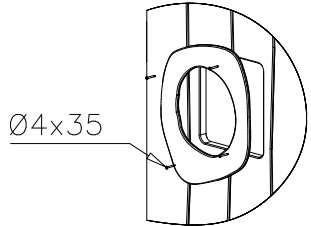
<p>DET 1</p>  <p>NOTE:  Walls contain  floor boom 705211.  HUOM:  Seinät sisältävät  lattia puomin 705211.</p>	<p>DET 2</p>  <p>Ø8x90 (903093)</p>	<p>DET 3</p>  <p>Ø5x60</p>	<p>DET 4</p>  <p>Ø4x35</p>



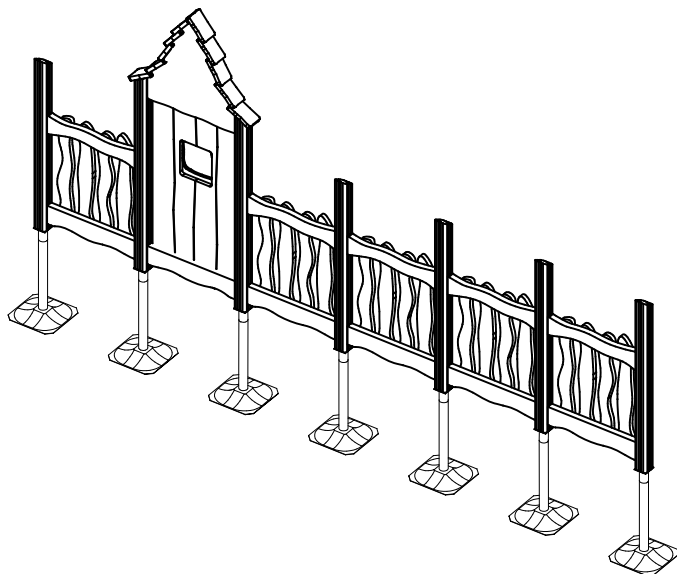
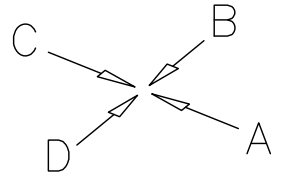
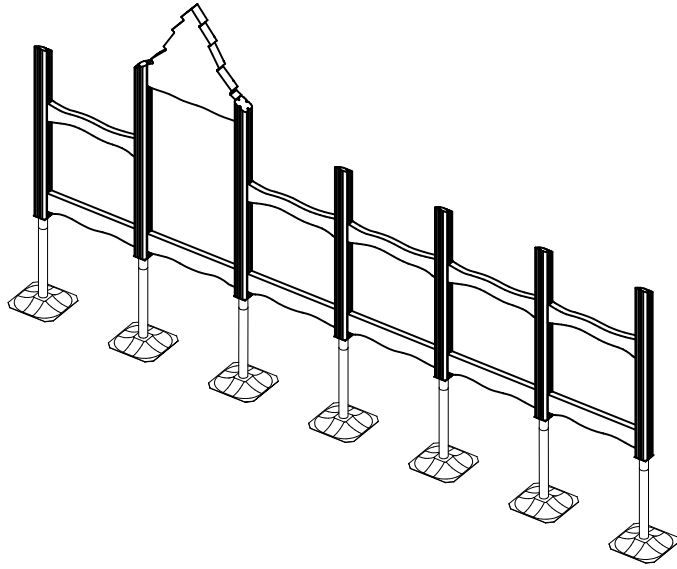





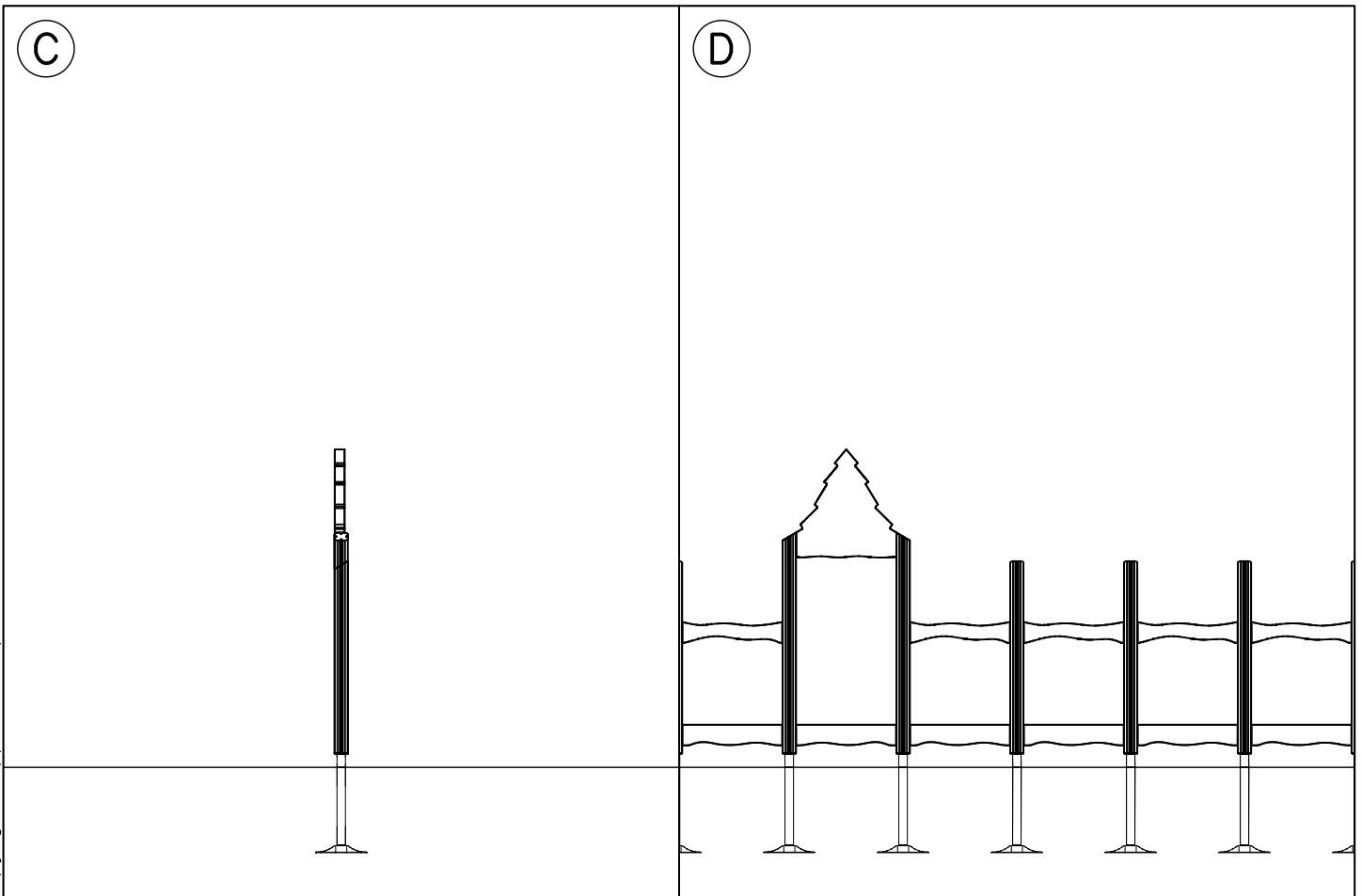
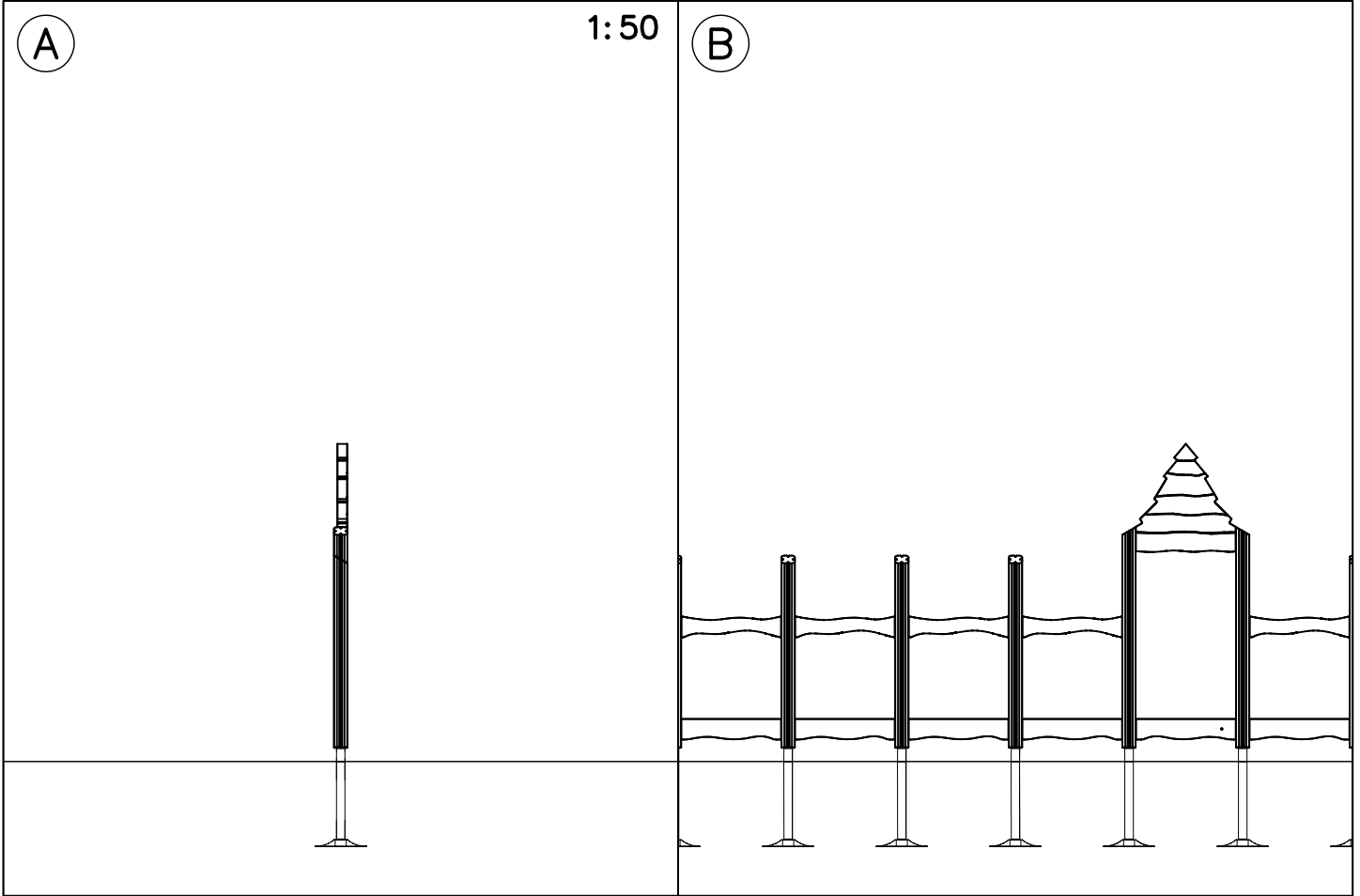

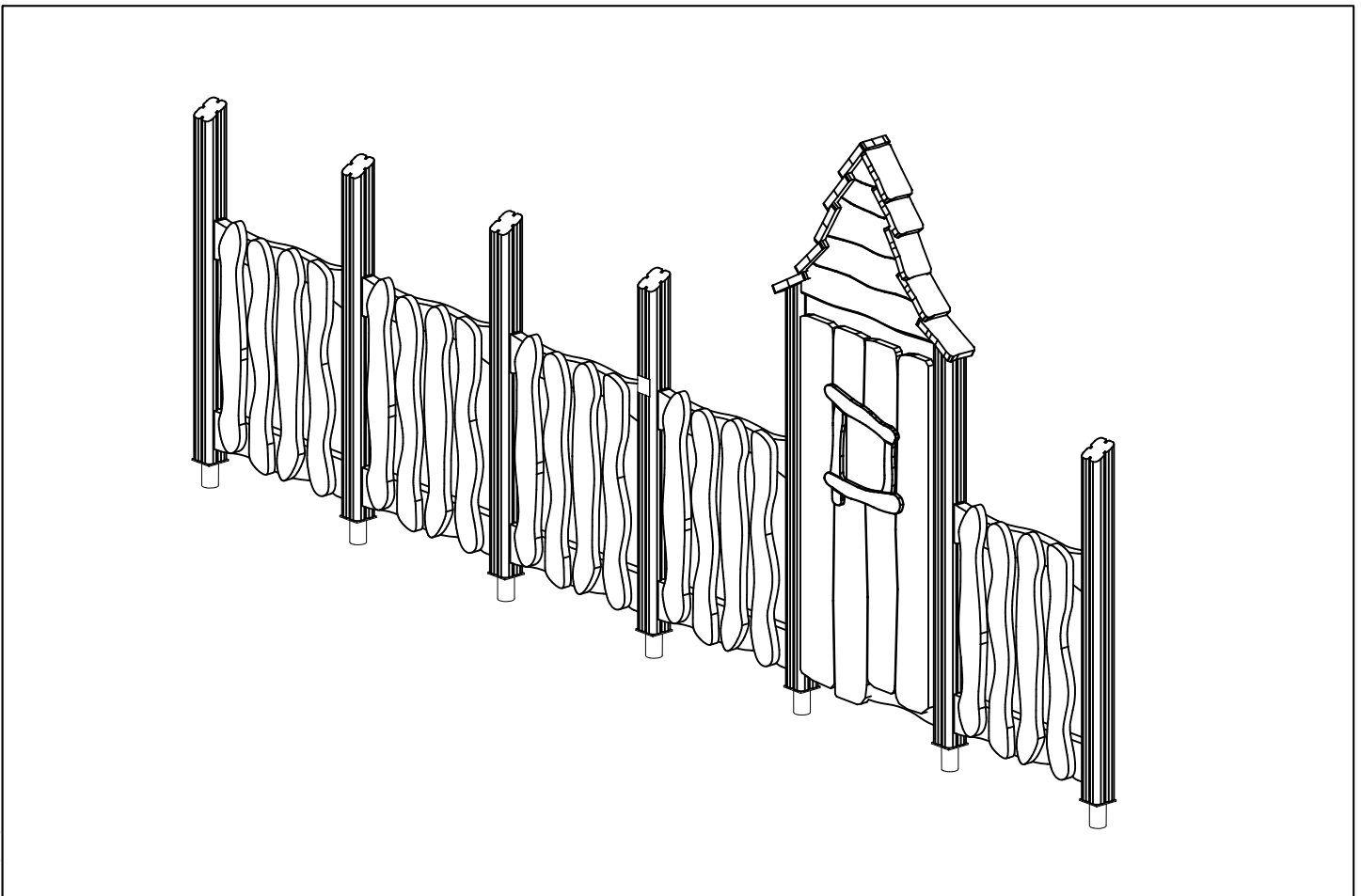
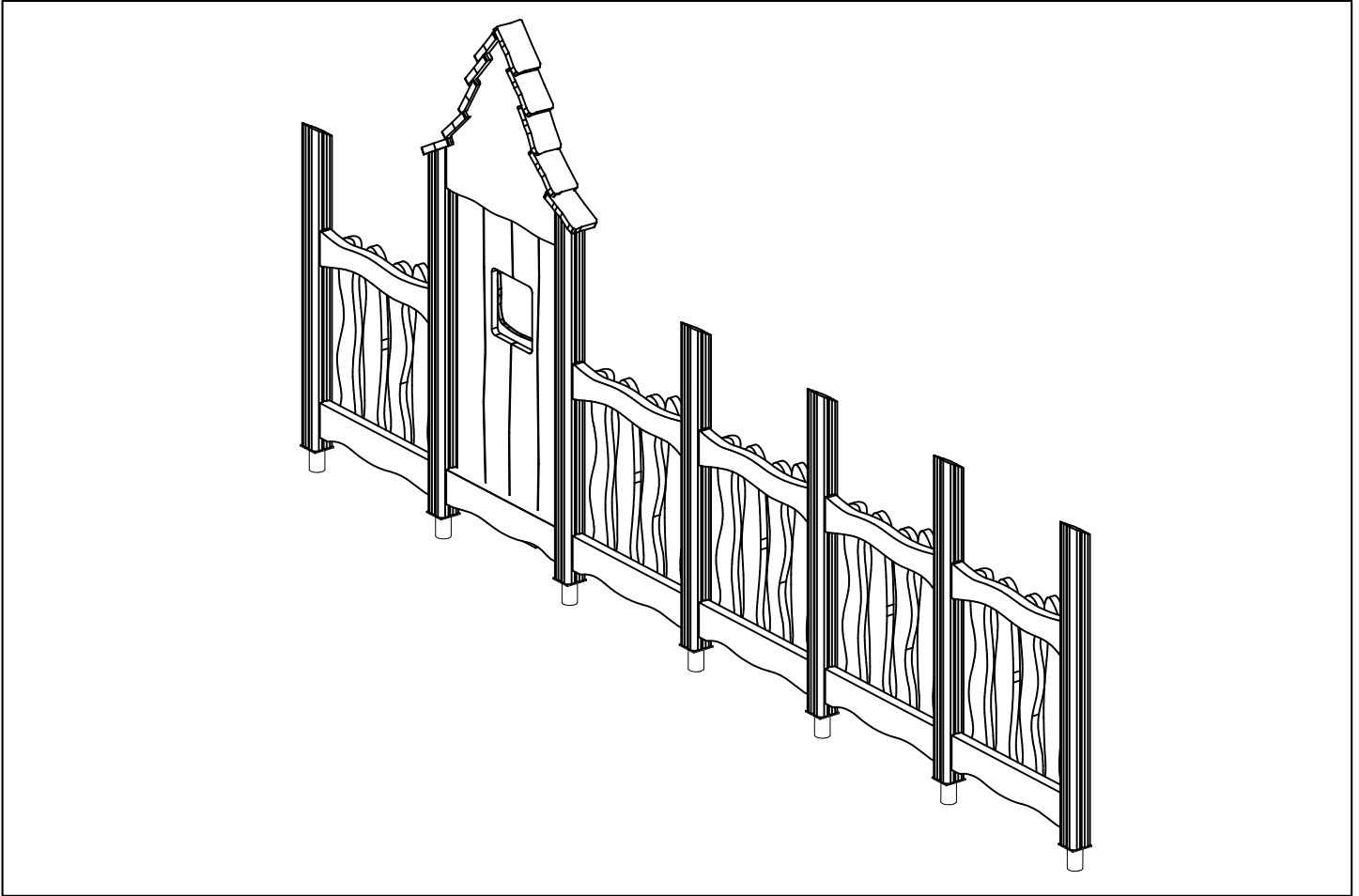
DATE: 26.6.2019

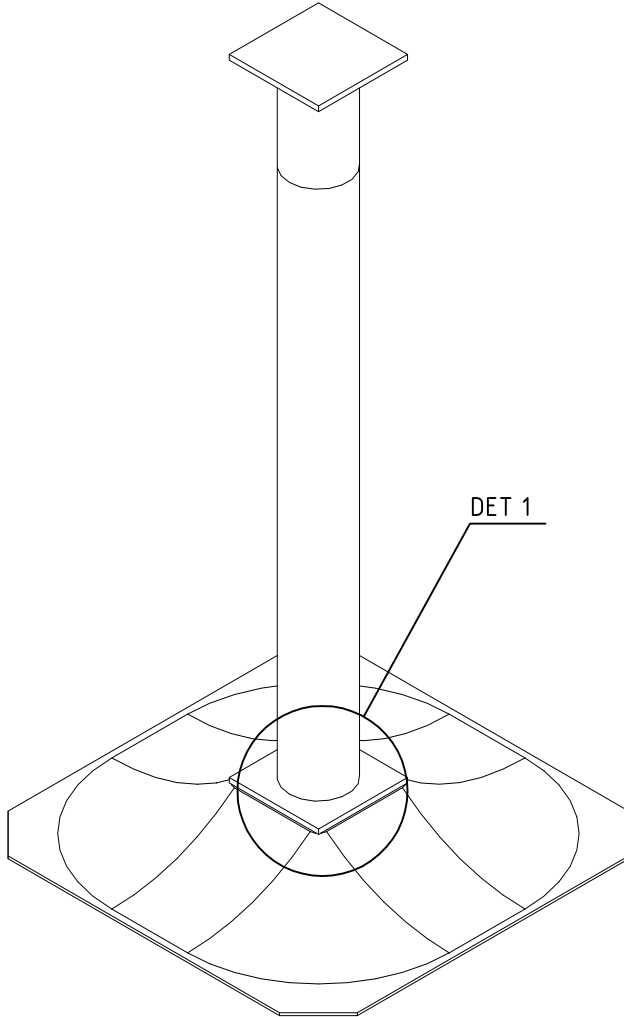
1:50



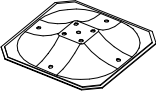



①	909511	PCS	②	909519	PCS
		1			1
③	909637	PCS	④	909638	PCS
		4			8
	M10			Ø20/10.5	
⑤	909639	PCS			PCS
		4			
	M10x25				
		PCS			PCS
		PCS			PCS
		PCS			PCS
		PCS			PCS
		PCS			PCS

DET 1

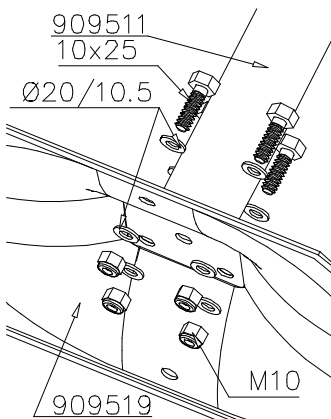



**LAPPSET®**  
**BETON FOUNDATION**

**FOOT**

DATE: 27.10.2015

**1(1)**

② 905104	PCS		PCS
	4		
 M10	PCS		PCS



905104

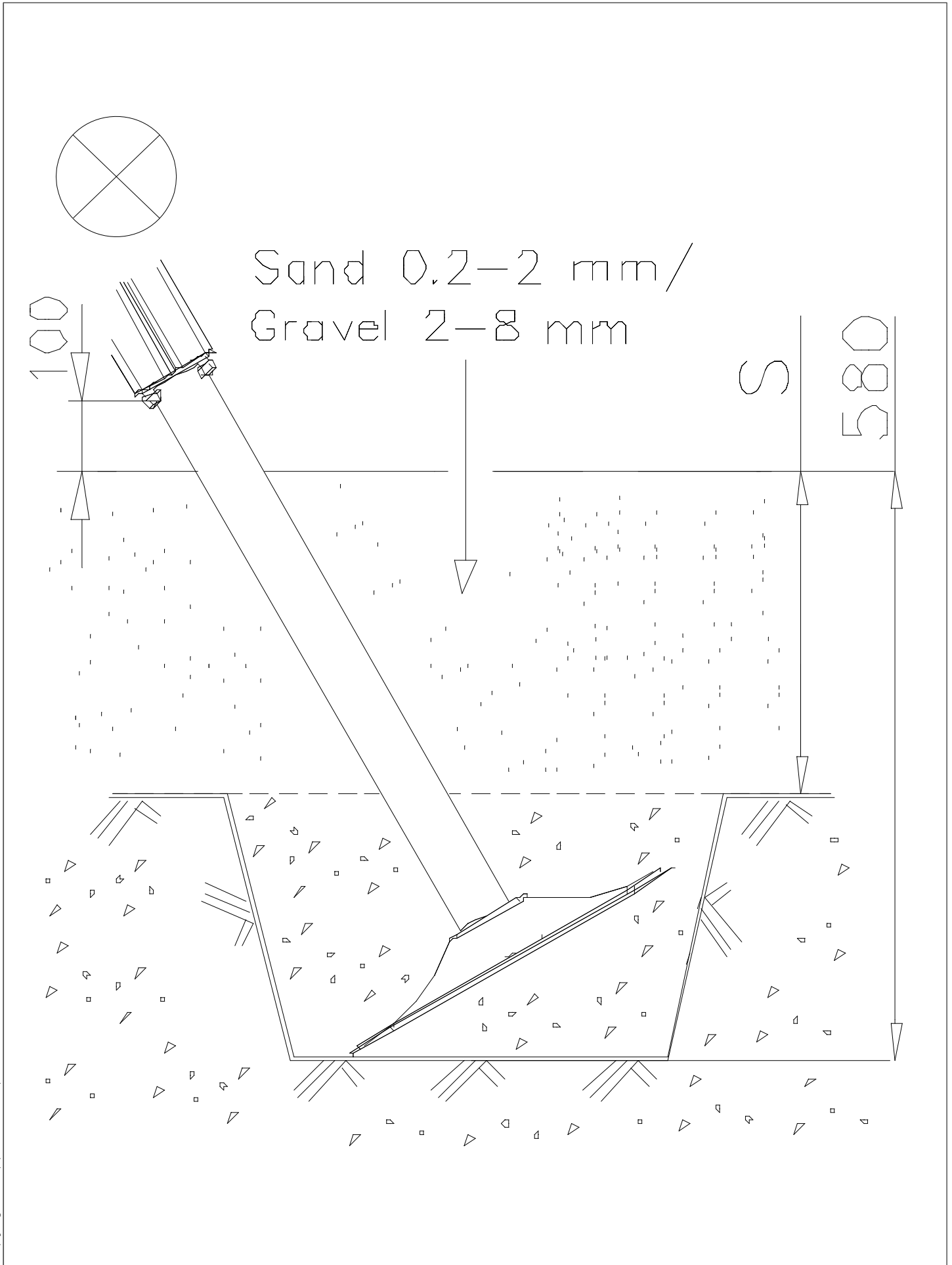



**Tuotekyltti tulee tuotteen mukana yhdellä seuraavista tavoista:**

**1) Metallinen tuotekyltti ja kiinnitysruuvit**

- Kiinnitä tuotekyltti ruuveilla tolppaan noin 2 metrin korkeuteen kuvan 1 mukaisesti.

**2) Tuotekylttitarra**

- Puhdista maalattu metalli- tai vaneripinta pölystä ja kosteudesta. Liimaa tarra kuvan 2 mukaisesti.
- Huom. Älä kiinnitä tarraa karheapintaiseen laminaattiin tai maalattuun puuhun.

**Vår produktmärkning levereras på ett av följande sätt:**

**1) Produktskylt i metall**

- Fäst skylten med de medföljande skruvarna

**2) Självhäftande produktetikett**

- Rengör den pulverlackerade metallytan eller laminatyten så att den blir fri från smuts och fukt. Fäst etiketten enligt fig. 2.
- Obs! Fäst ej etiketten på detaljer med skrovlig yta eller på målat trä.

**Product label is delivered by one of following ways:**

**1) Metal product label and screws**

- Fasten the label with screws.

**2) Label sticker**

- Clean the painted metal or plywood surface from dirt and moisture. Fasten the sticker as shown in the figure 2.
- Note. Do not attach the sticker to rough surfaced laminate or painted wood.

**La plaque d'informations produit est livrée sous l'une de ces 3 formes :**

**1) Plaque métallique et vis**

- Fixez la plaque à l'aide des vis.

**2) Etiquette autocollante**

- Avant de coller l'étiquette, nettoyez le composant métallique peint ou la plaque de contreplaqué, de toute saleté. La surface doit être sèche (voir image 2).
- Attention, ne pas coller l'étiquette sur une surface lamellé-collée irrégulière ou sur du bois peint.

**Die Auslieferung des Produktaufklebers erfolgt auf eine dieser Arten:**

**1) Produkt-Schild aus Metall incl. Schrauben**



- Die Befestigung des Schildes erfolgt mittels der Schrauben.

**2) Aufkleber**

- Entfernen Sie zunächst Schmutz und Feuchtigkeit vom lackierten Metall bzw. von der Holzoberfläche und bringen Sie den Aufkleber wie im Bild oben rechts beschrieben auf den gesäuberten Untergrund auf.
- Beachten Sie: Bringen Sie den Aufkleber nicht auf raues laminiertes oder lackiertes Holz an.

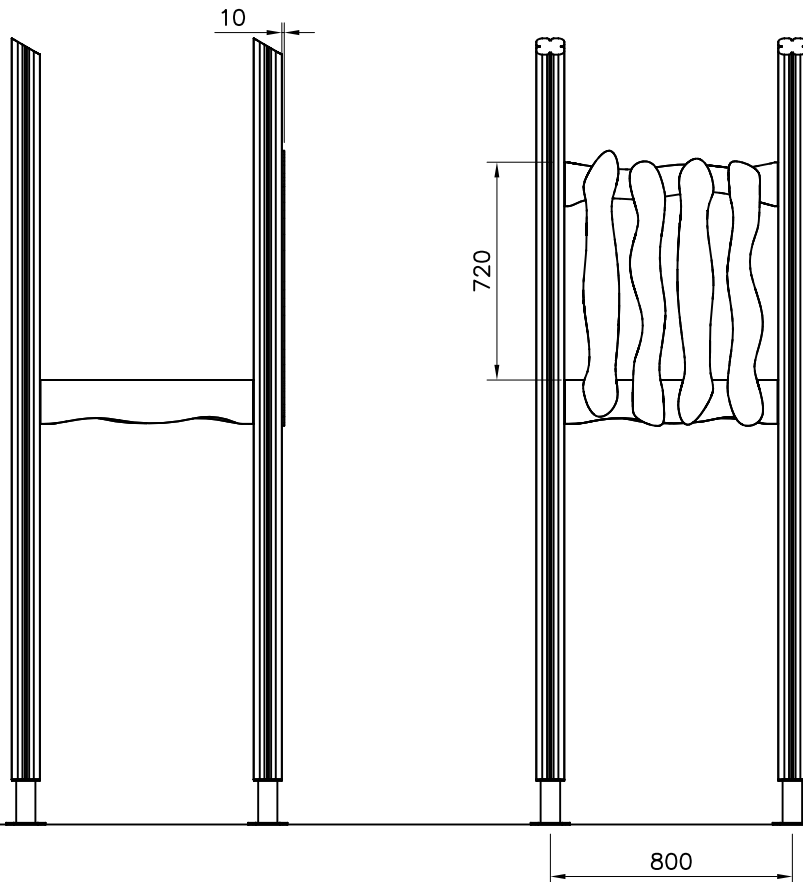
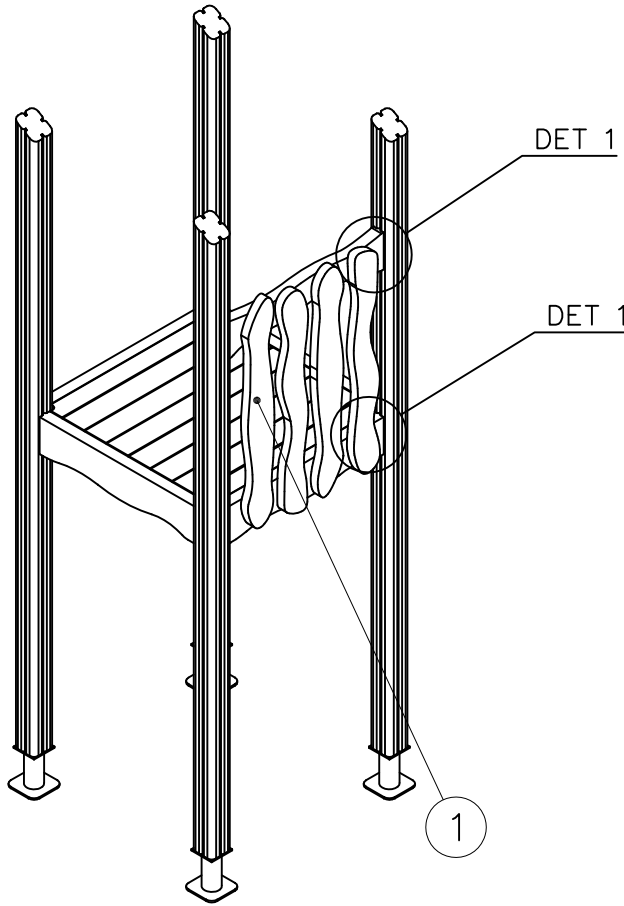

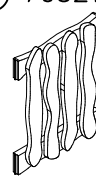

① 705210	PCS	② 903093	PCS
	1		8
		Ø8x90	
	PCS		PCS
	PCS		PCS
	PCS		PCS
	PCS		PCS

DET 1

