

LAPPSET®









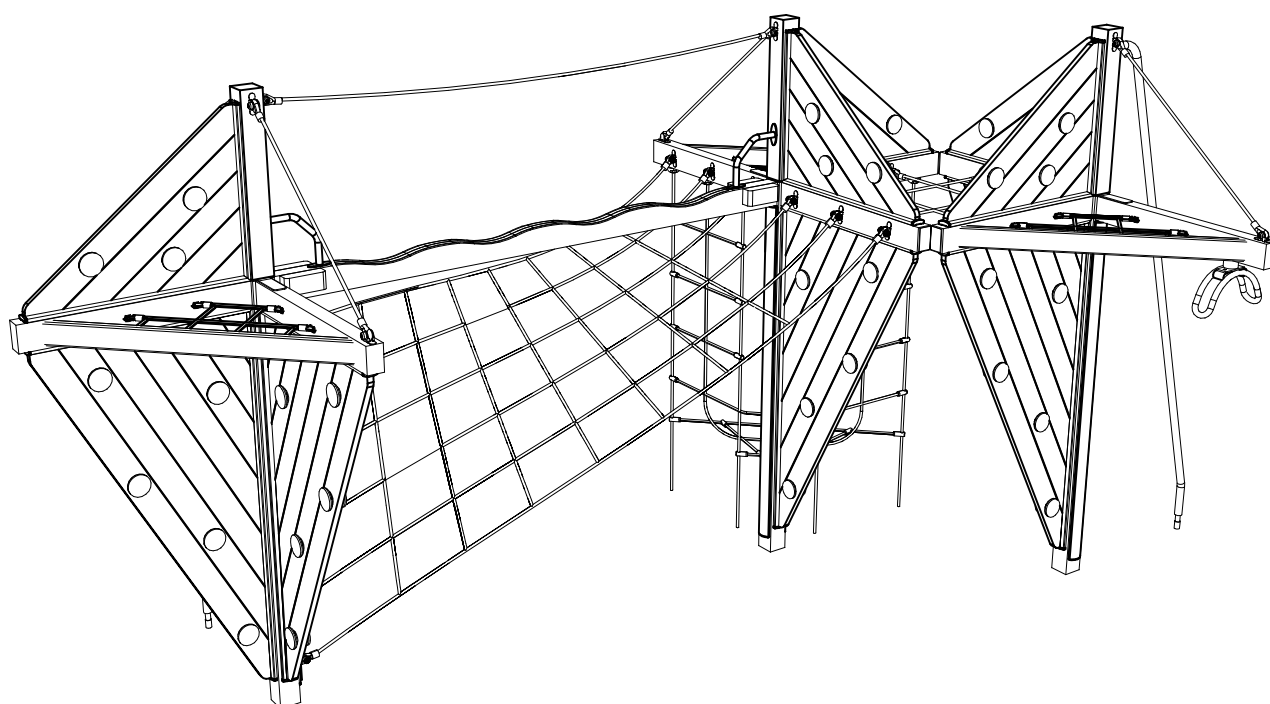

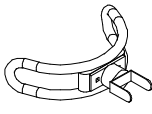
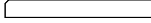
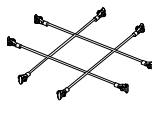
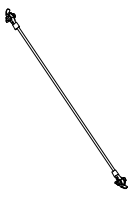

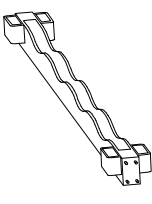
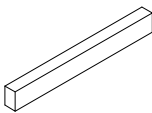
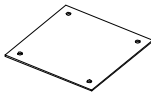
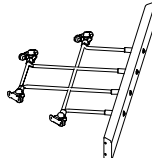

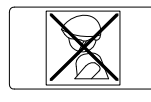

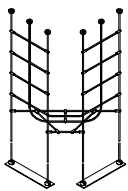
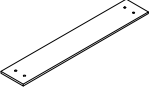
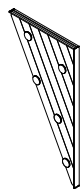
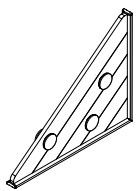

CLUB

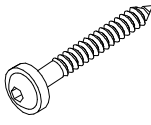
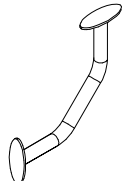
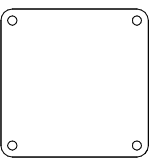
ASENNUSOHJE
MONTERINGSANSVISNING
INSTALLATION INSTRUCTION
AUFBAUANLEITUNG
NOTICE D'INSTALLATION

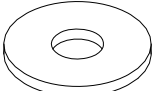
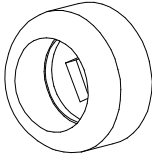
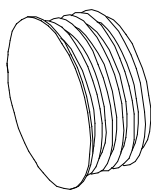
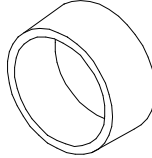
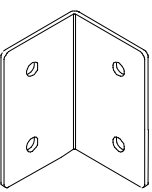
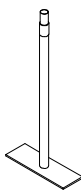
REF: 150310M
DATE: 30.11.2015

150310M

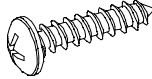
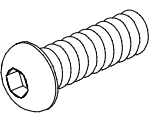
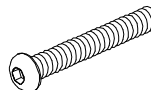
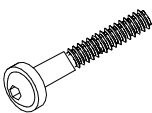
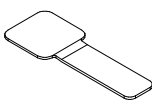

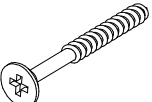
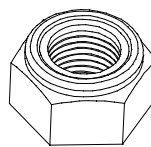
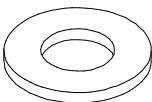
005358	PCS 1	005363	PCS 1	006876	PCS 1	006877	PCS 3	006879	PCS 1	006889	PCS 1
											
		L 1200				L 1420		L 3340		L 3300	
006892	PCS 8	009917	PCS 3	700219	PCS 3	702286	PCS 1	702339	PCS 1	702907	PCS 4
											
L 1200		350x350		L 1670		90x50		90x50		L 2200	
702914	PCS 2	702917	PCS 3	702935	PCS 1	702936	PCS 2	707570	PCS 5	707592	PCS 5
											
L 2350		L 975						L 2135		Seinä	
707614	PCS 1	900240	PCS 110	901798	PCS 2	902487	PCS 2	903454	PCS 2	905051	PCS 24
											
		8x70				65x65		L 3210		Ø24/8.5	
905083	PCS 12	905103	PCS 24	905112	PCS 12	905211	PCS 2	907040	PCS 2	909215	PCS 12
											
Ø32		PT-28/32-H		Ø22						HPM 16x280	
909233	PCS 12	909243	PCS 90	909506	PCS 8	909850	PCS 72	909851	PCS 24	909876	PCS 8
											
8x100		6x60		Ø3.5x13		M8x25 RST		8x55 RST		M8x40	
929341	PCS 3	960100	PCS 162	960120	PCS 3	980107	PCS 12	980150	PCS 8	980151	PCS 110
											
		Ø20		L 2900		6x60		M8		Ø16/8.4	

EN/AS Impact Area 61.9 m²
Geid Size = 500 mm

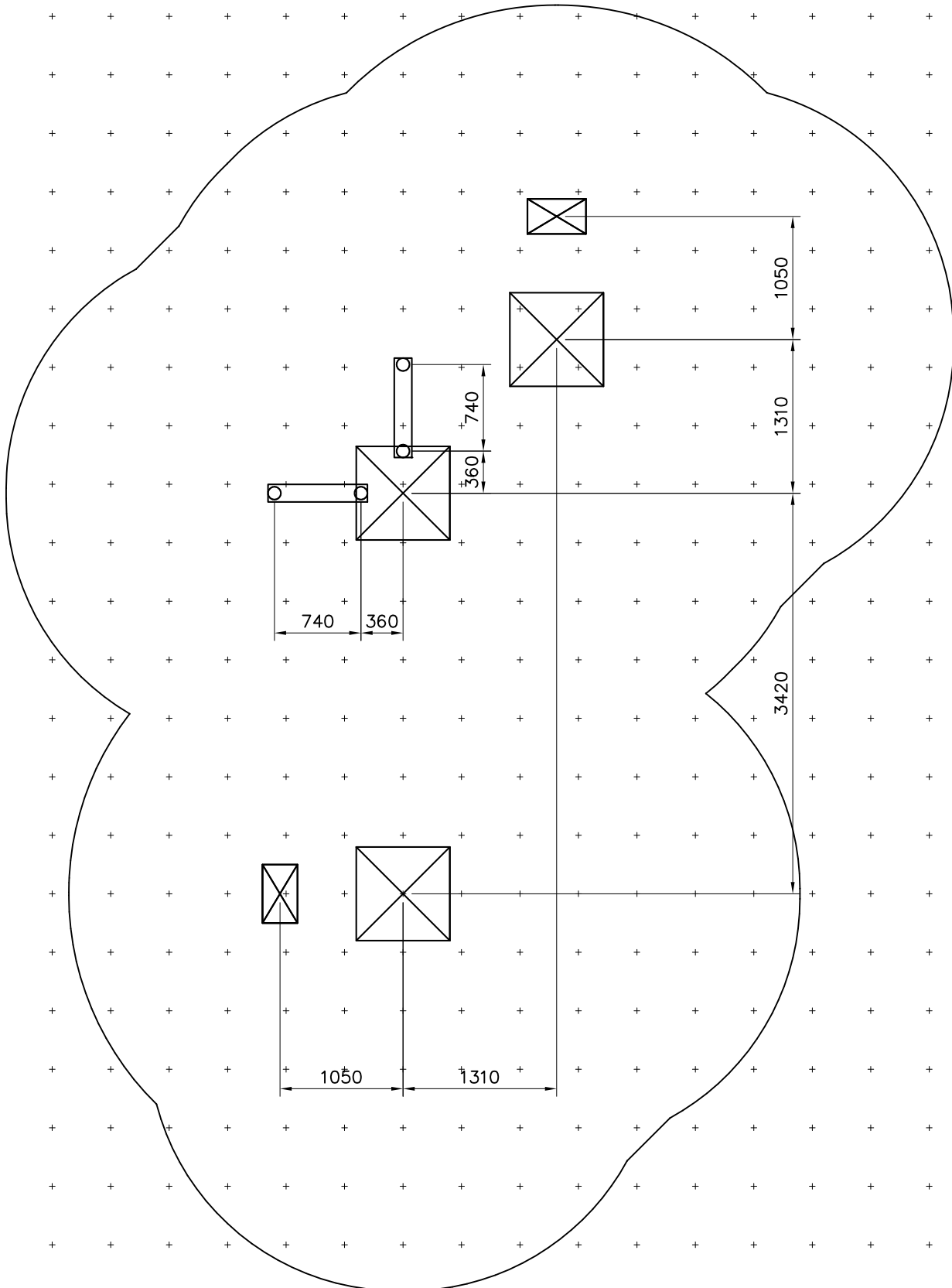
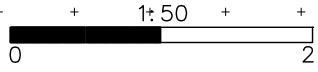

EN/AS Impact Area 61.9 m²

Falling Space 61.9 m²

Max Falling Height 2740 mm

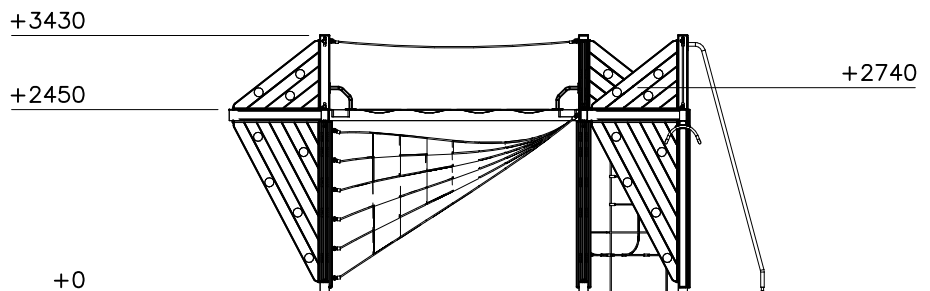
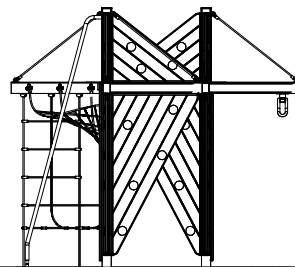
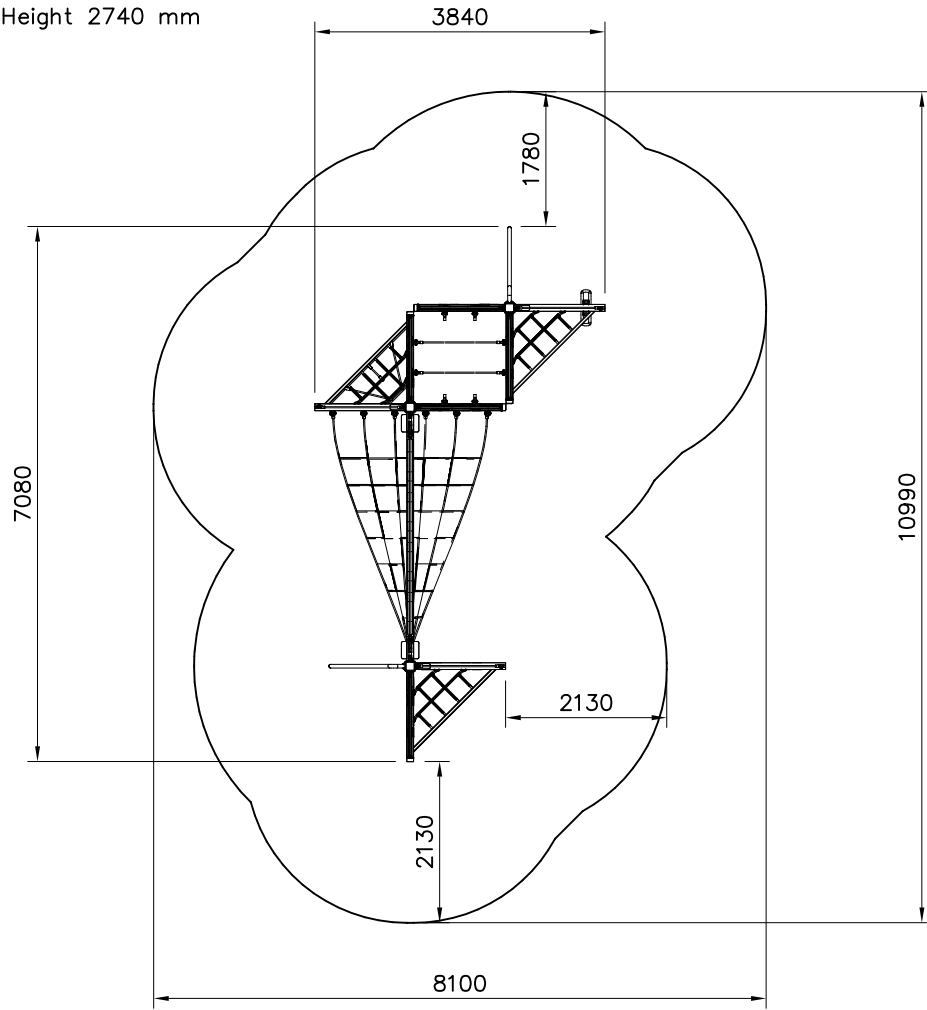
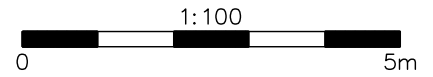

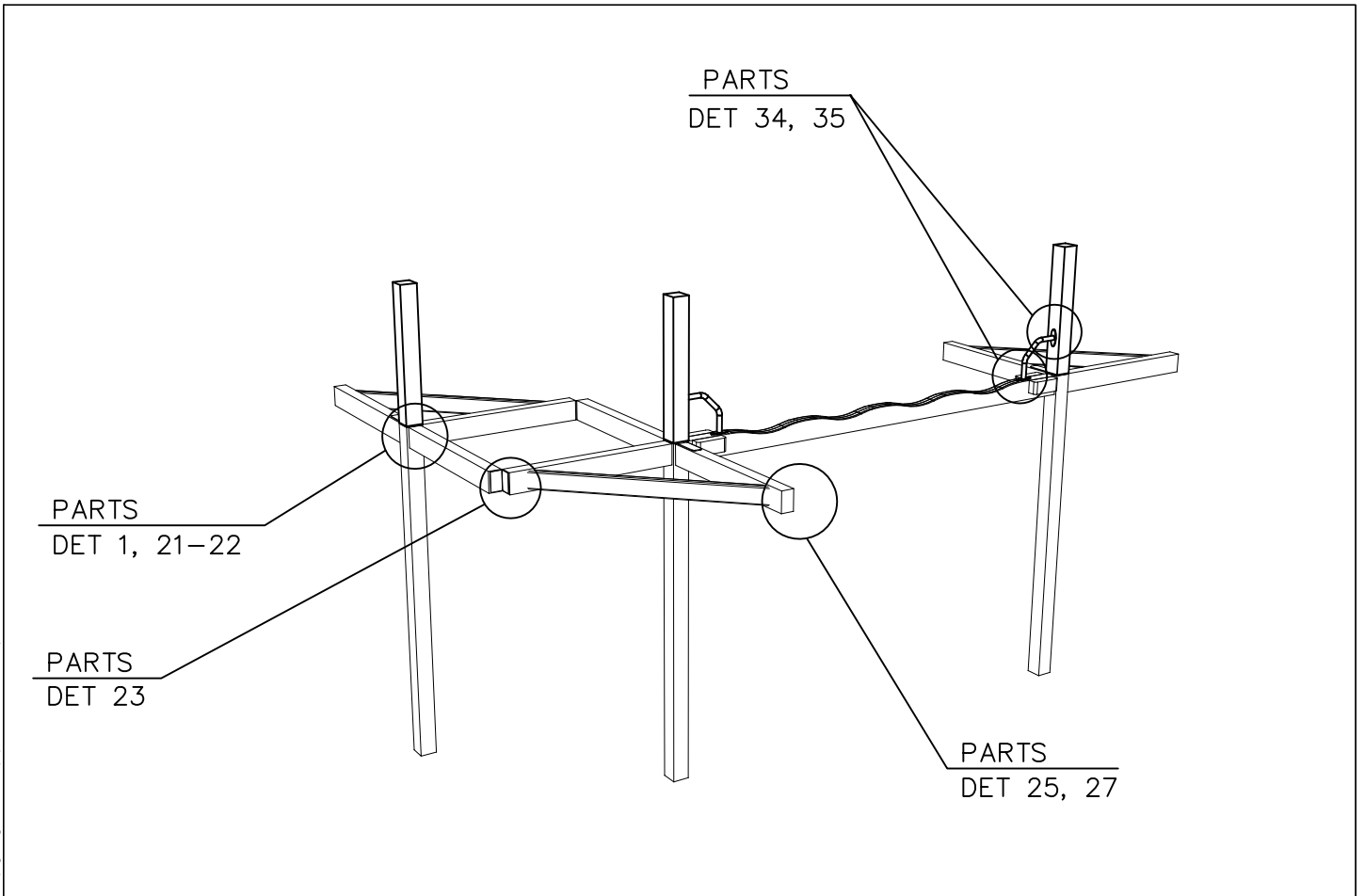
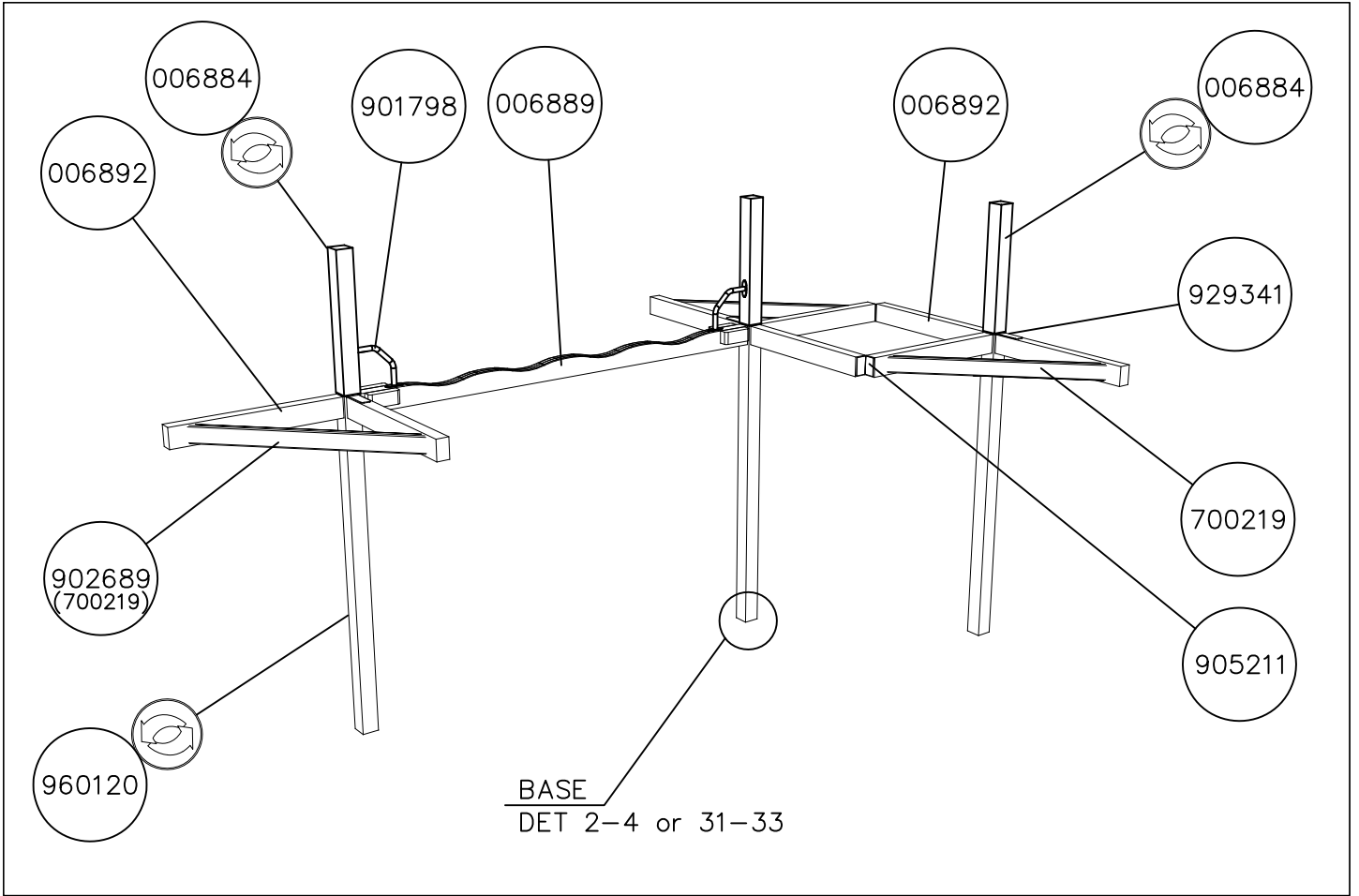

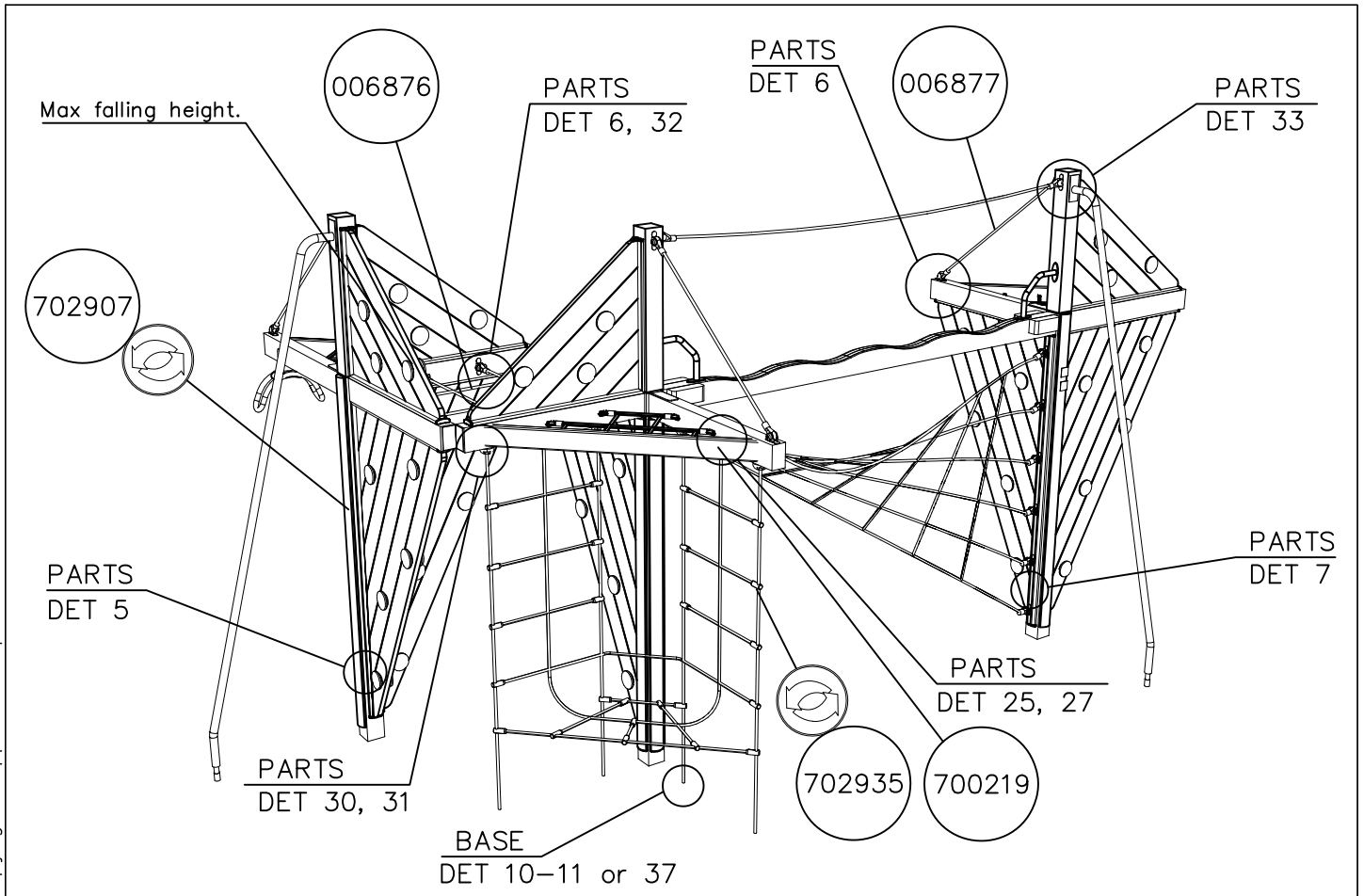
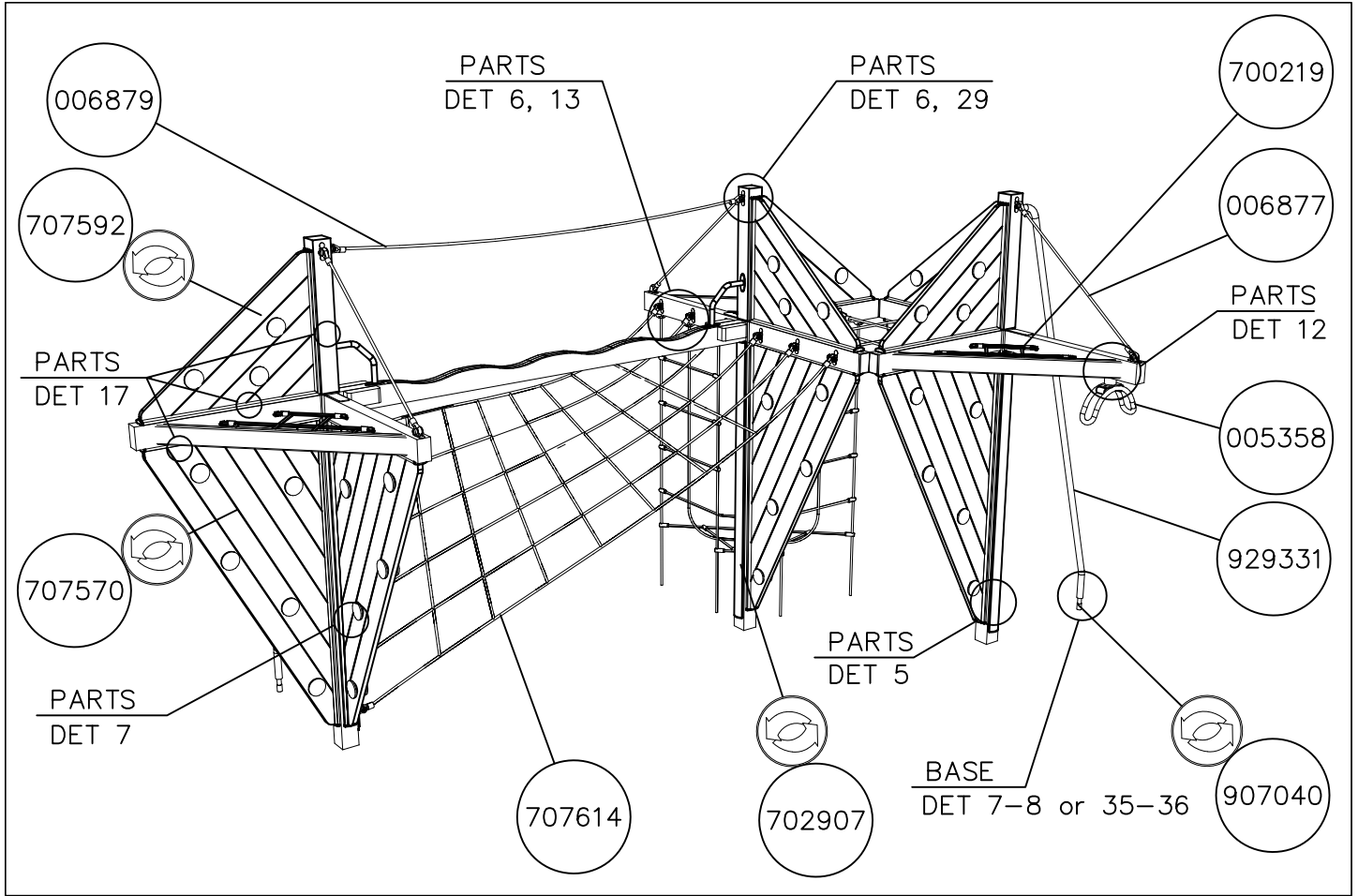



<p>DET 1</p>	<p>DET 2</p>	<p>DET 3</p>	<p>DET 4</p>
<p>DET 5</p>	<p>DET 6</p>	<p>DET 7</p>	<p>DET 8</p>
<p>DET 9</p>	<p>DET 10</p>	<p>DET 11</p>	<p>DET 12</p>
<p>DET 13</p>	<p>DET 14</p>	<p>DET 15</p>	<p>DET 16</p>
<p>DET 17</p>	<p>DET 18</p>	<p>DET 19</p>	<p>DET 20</p>



<p>DET 21</p> <p>M10</p>	<p>DET 22</p> <p>006884 6x60</p>	<p>DET 23</p> <p>8x70 905211</p>	<p>DET 24</p>
<p>DET 25</p> <p>905083 Ø16/8,4 8x100 905112</p>	<p>DET 27</p> <p>>Ø230mm >Ø230mm >Ø230mm >Ø230mm</p>	<p>DET 28</p>	
<p>DET 29</p> <p>70</p>	<p>DET 30</p> <p>8x70</p>	<p>DET 31</p> <p>370 370 70</p>	<p>DET 32</p> <p>400 400 400</p>
<p>DET 33</p> <p>8x70 903454</p>	<p>DET 34</p> <p>8x70</p>	<p>DET 35</p> <p>8x70</p>	<p>DET 36</p>
<p>DET 37</p> <p>660 660 660 660 660</p>	<p>DET 38</p> <p>1650 400 400</p>	<p>DET 39</p> <p>1650 500 500 500 500</p>	<p>DET 40</p>

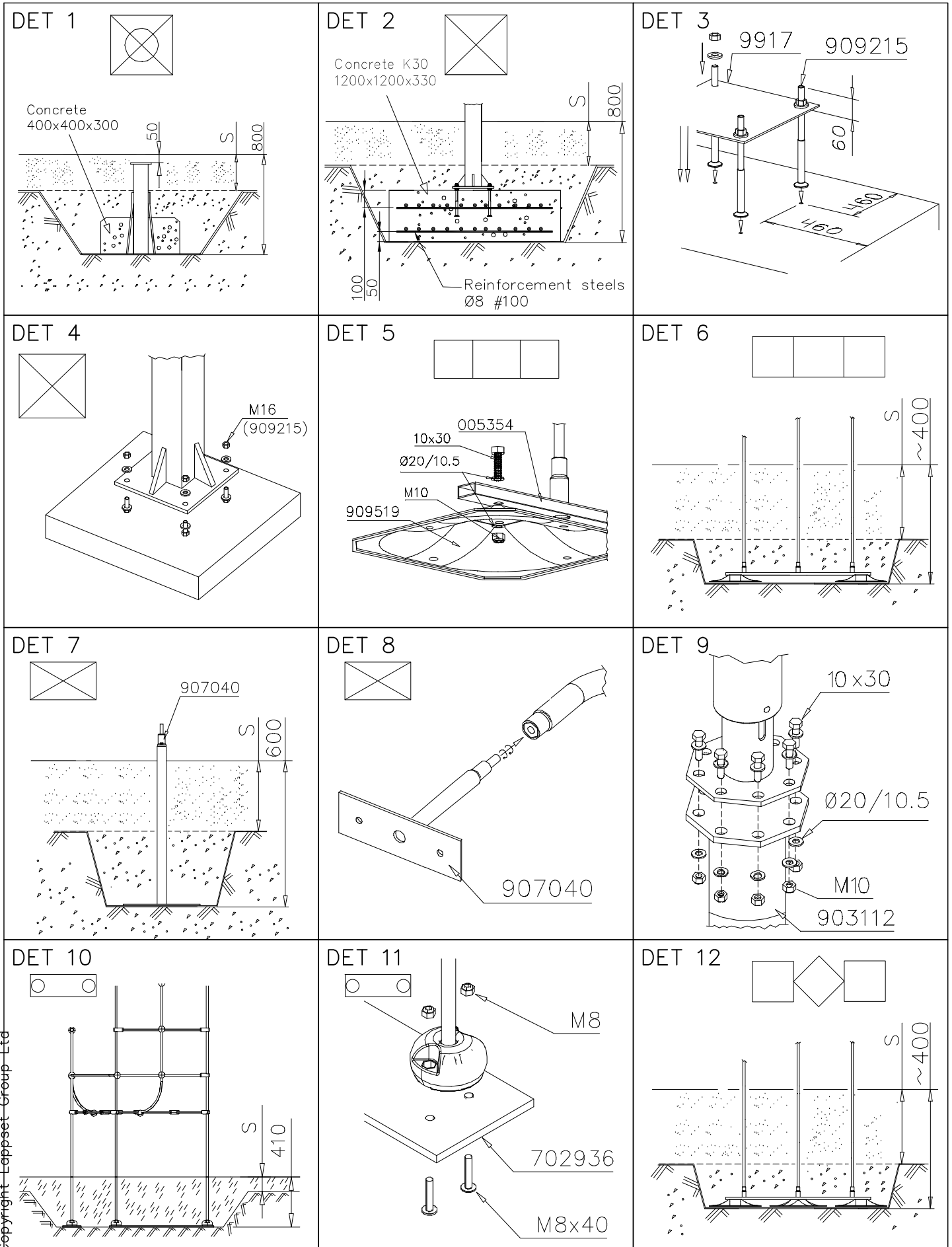

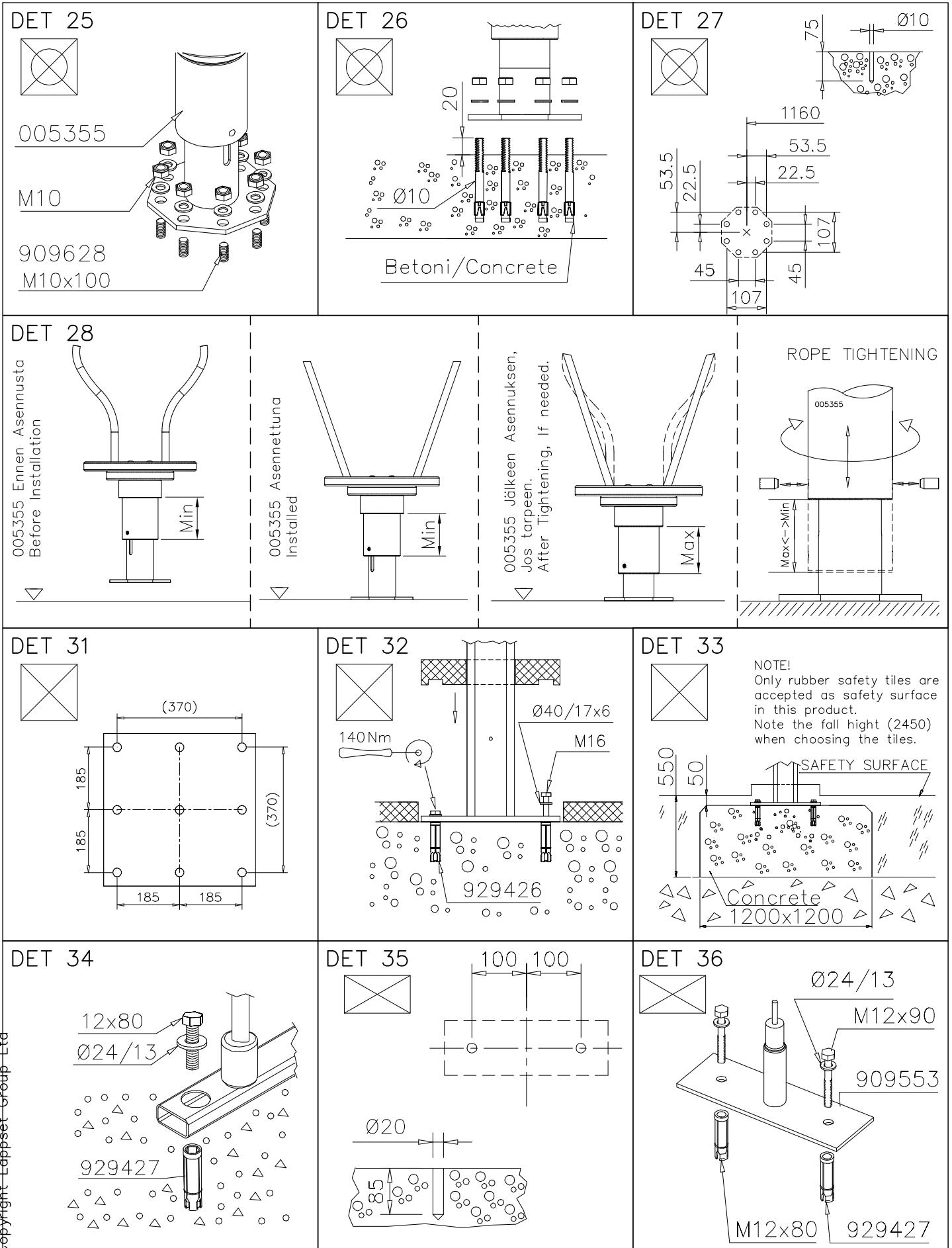



<p>DET 37</p>	<p>DET 38</p>	<p>DET 39</p>
<p>DET 40</p>	<p>DET 41</p>	<p>DET 42</p>
<p>DET 43</p>	<p>DET 44</p>	<p>DET 45</p>
<p>DET 46</p>	<p>DET 47</p>	<p>DET 48</p>



Tuotekyltti tulee tuotteen mukana yhdellä seuraavista tavoista:

1) Metallinen tuotekyltti ja kiinnitysruuvit

- Kiinnitä tuotekyltti ruuveilla tolppaan noin 2 metrin korkeuteen kuvan 1 mukaisesti.

2) Tuotekylttitarra

- Puhdista maalattu metalli- tai vaneripinta pölystä ja kosteudesta. Liimaa tarra kuvan 2 mukaisesti.
- Huom. Älä kiinnitä tarraa karheapintaiseen laminaattiin tai maalattuun puuhun.

Vår produktmärkning levereras på ett av följande sätt:

1) Produktskylt i metall

- Fäst skylten med de medföljande skruvarna

2) Självhäftande produktetikett

- Rengör den pulverlackerade metallytan eller laminatyten så att den blir fri från smuts och fukt. Fäst etiketten enligt fig. 2.
- Obs! Fäst ej etiketten på detaljer med skrovlig yta eller på målat trä.

Product label is delivered by one of following ways:

1) Metal product label and screws

- Fasten the label with screws.

2) Label sticker

- Clean the painted metal or plywood surface from dirt and moisture. Fasten the sticker as shown in the figure 2.
- Note. Do not attach the sticker to rough surfaced laminate or painted wood.

La plaque d'informations produit est livrée sous l'une de ces 3 formes :

1) Plaque métallique et vis

- Fixez la plaque à l'aide des vis.

2) Etiquette autocollante

- Avant de coller l'étiquette, nettoyez le composant métallique peint ou la plaque de contreplaqué, de toute saleté. La surface doit être sèche (voir image 2).
- Attention, ne pas coller l'étiquette sur une surface lamellé-collée irrégulière ou sur du bois peint.

Die Auslieferung des Produktaufklebers erfolgt auf eine dieser Arten:

1) Produkt-Schild aus Metall incl. Schrauben

- Die Befestigung des Schildes erfolgt mittels der Schrauben.

2) Aufkleber

- Entfernen Sie zunächst Schmutz und Feuchtigkeit vom lackierten Metall bzw. von der Holzoberfläche und bringen Sie den Aufkleber wie im Bild oben rechts beschrieben auf den gesäuberten Untergrund auf.
- Beachten Sie: Bringen Sie den Aufkleber nicht auf raues laminiertes oder lackiertes Holz an.