

LAPPSET®









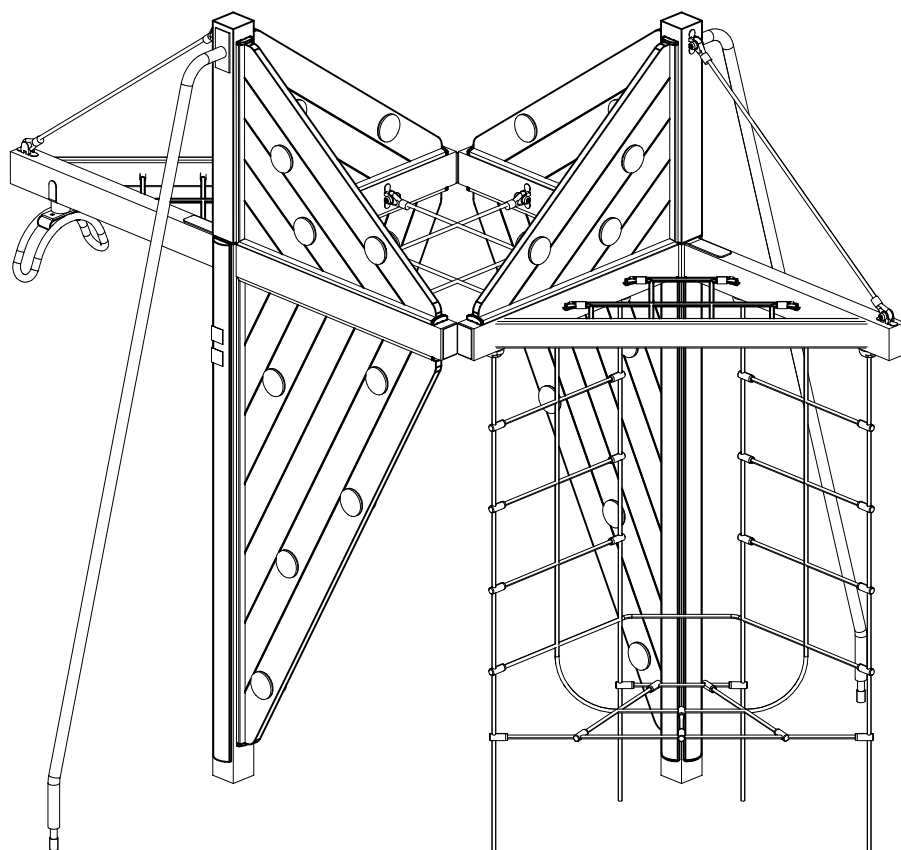

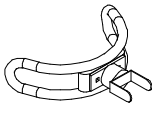
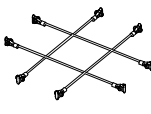
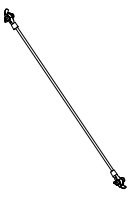
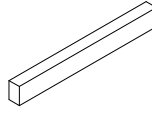
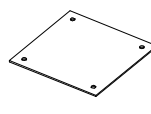
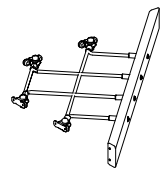

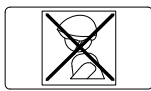



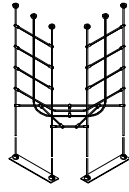
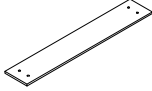
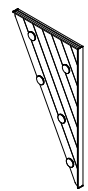
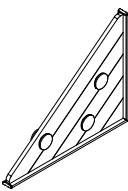

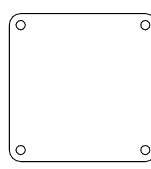



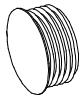

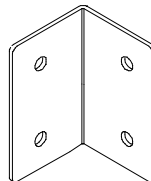

CLUB

ASENNUSOHJE
MONTERINGSANSVISNING
INSTALLATION INSTRUCTION
AUFBAUANLEITUNG
NOTICE D'INSTALLATION

REF: 150211M
DATE: 30.11.2015

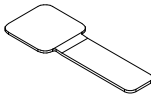
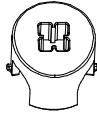
150211M



005358	PCS 1	006876	PCS 1	006877	PCS 2	006892	PCS 6	009917	PCS 2	700219	PCS 2
											
				L 1420		L 1200		350x350		L 1670	
702286	PCS 1	702339	PCS 1	702907	PCS 3	702914	PCS 2	702917	PCS 2	702935	PCS 1
											
90x50		90x50		L 2200		L 2350		L 975			
702936	PCS 2	707570	PCS 3	707592	PCS 4	900240	PCS 74	902487	PCS 2	903454	PCS 2
											
		L 2135		Seinä		8x70		65x65		L 3210	
905051	PCS 20	905083	PCS 8	905103	PCS 20	905112	PCS 8	905211	PCS 2	907040	PCS 2
											
Ø24/8.5		Ø32		PT-28/32-H		Ø22					
909215	PCS 8	909233	PCS 8	909243	PCS 66	909506	PCS 8	909850	PCS 36	909851	PCS 20
											
HPM 16x280		8x100		6x60		Ø3.5x13		8x25		8x55 RST	
909876	PCS 8	929341	PCS 2	960100	PCS 102	960120	PCS 2	980107	PCS 8	980150	PCS 8
											
M8x40				Ø20		L 2900		6x60		M8	
980151	PCS 82		PCS		PCS		PCS		PCS	PCS	
											
Ø16/8.4											

EN/AS Impact Area 40.1 m²

Grid size = 500 mm

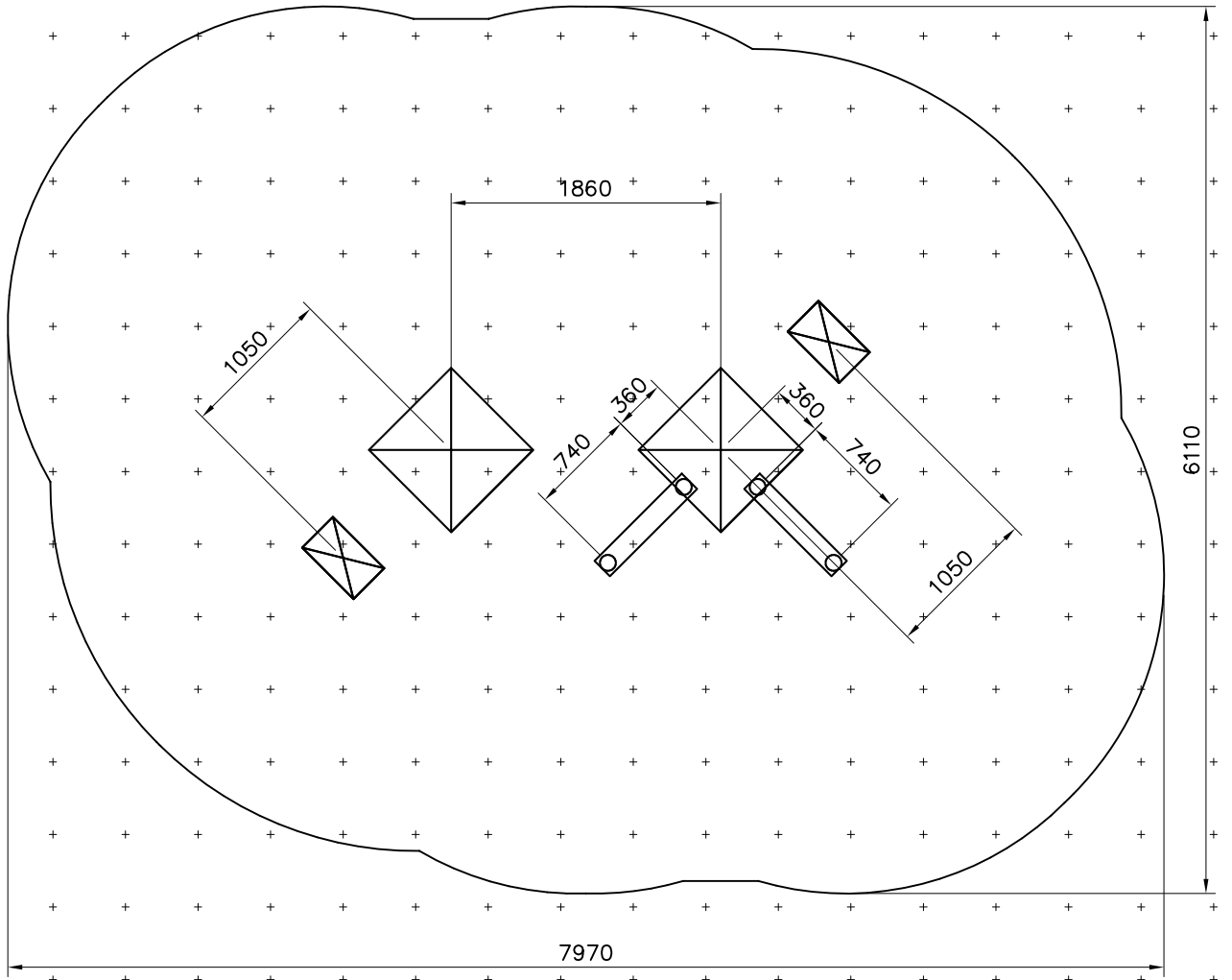
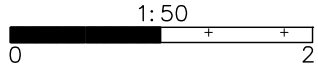

—— EN/AS Impact Area 40.1 m²
 - - - - Falling Space 40.1 m²
 Max Falling Height 2740 mm

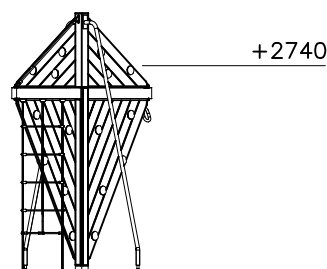
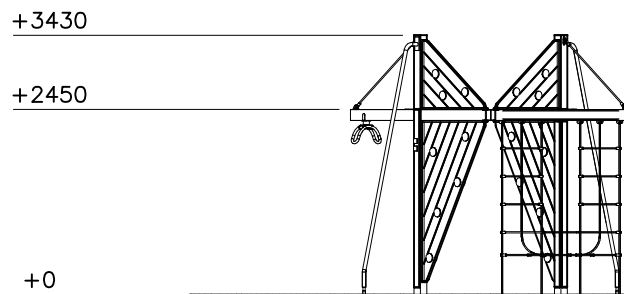
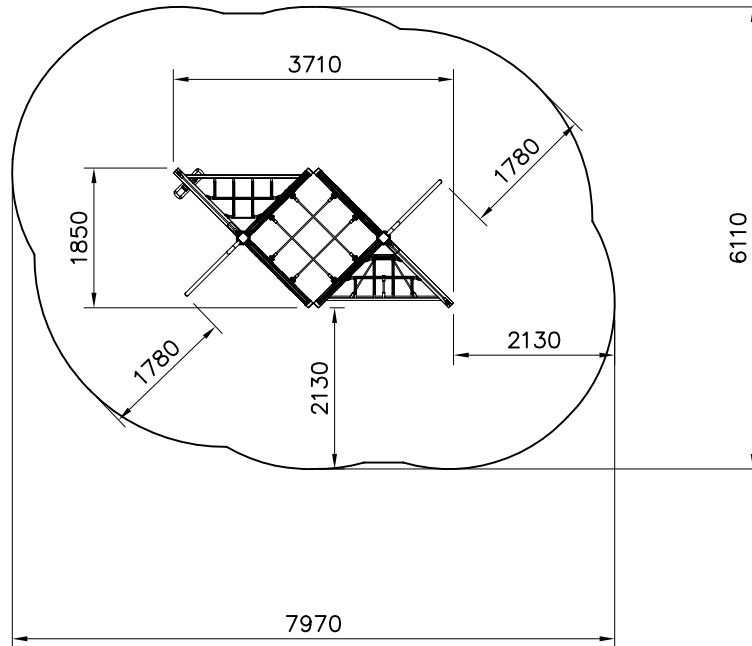
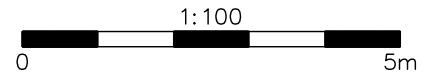

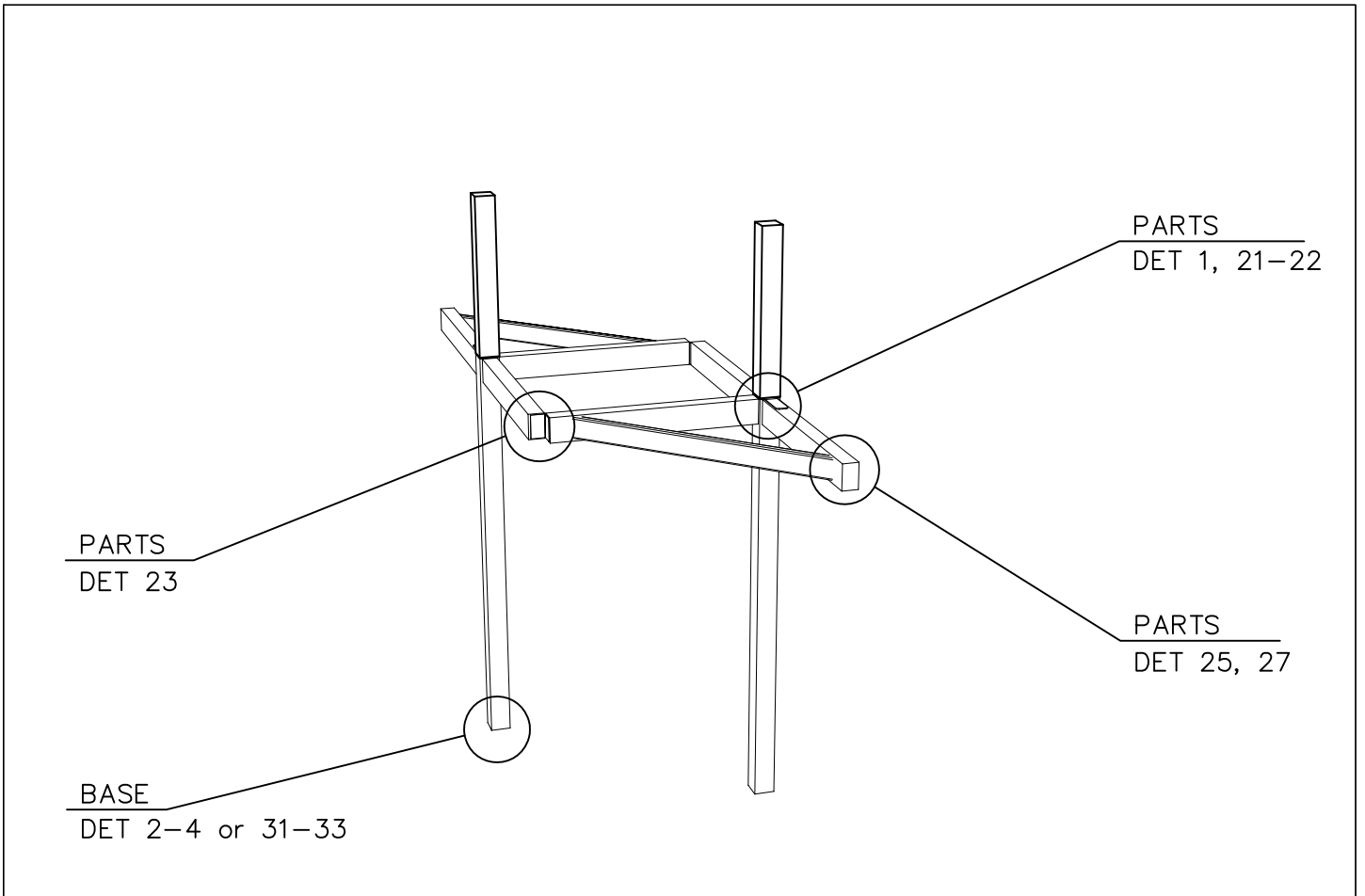
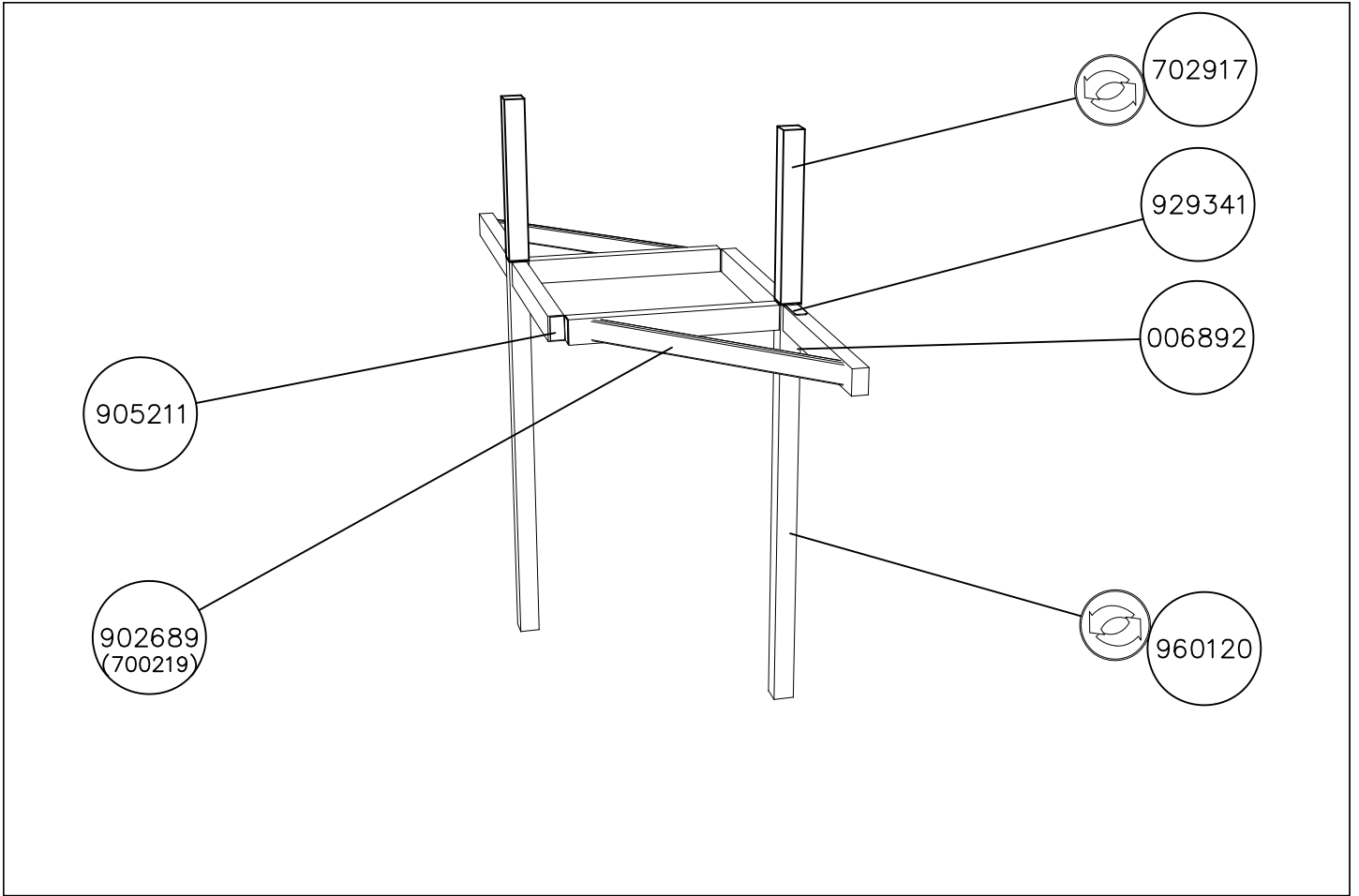

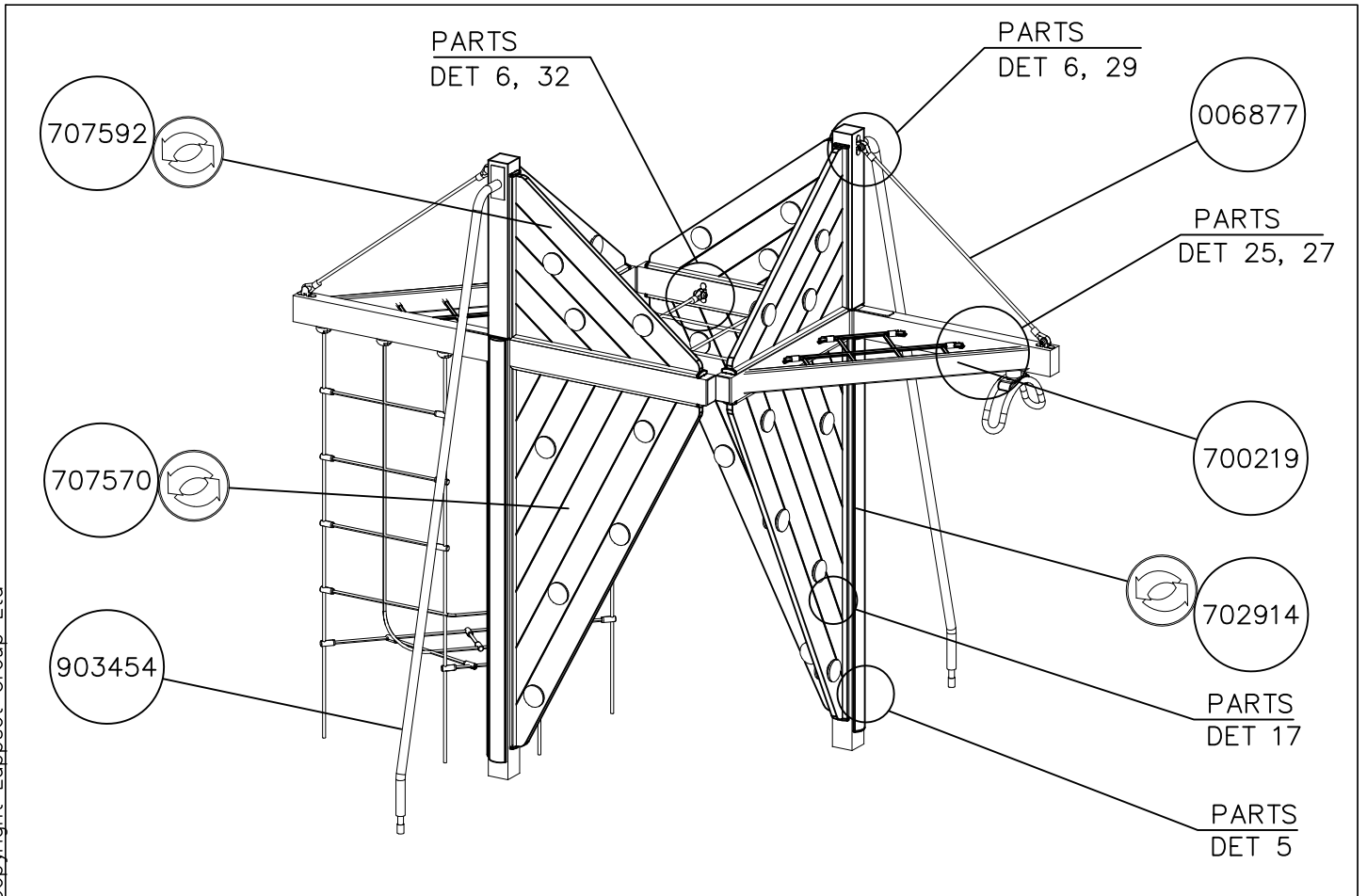
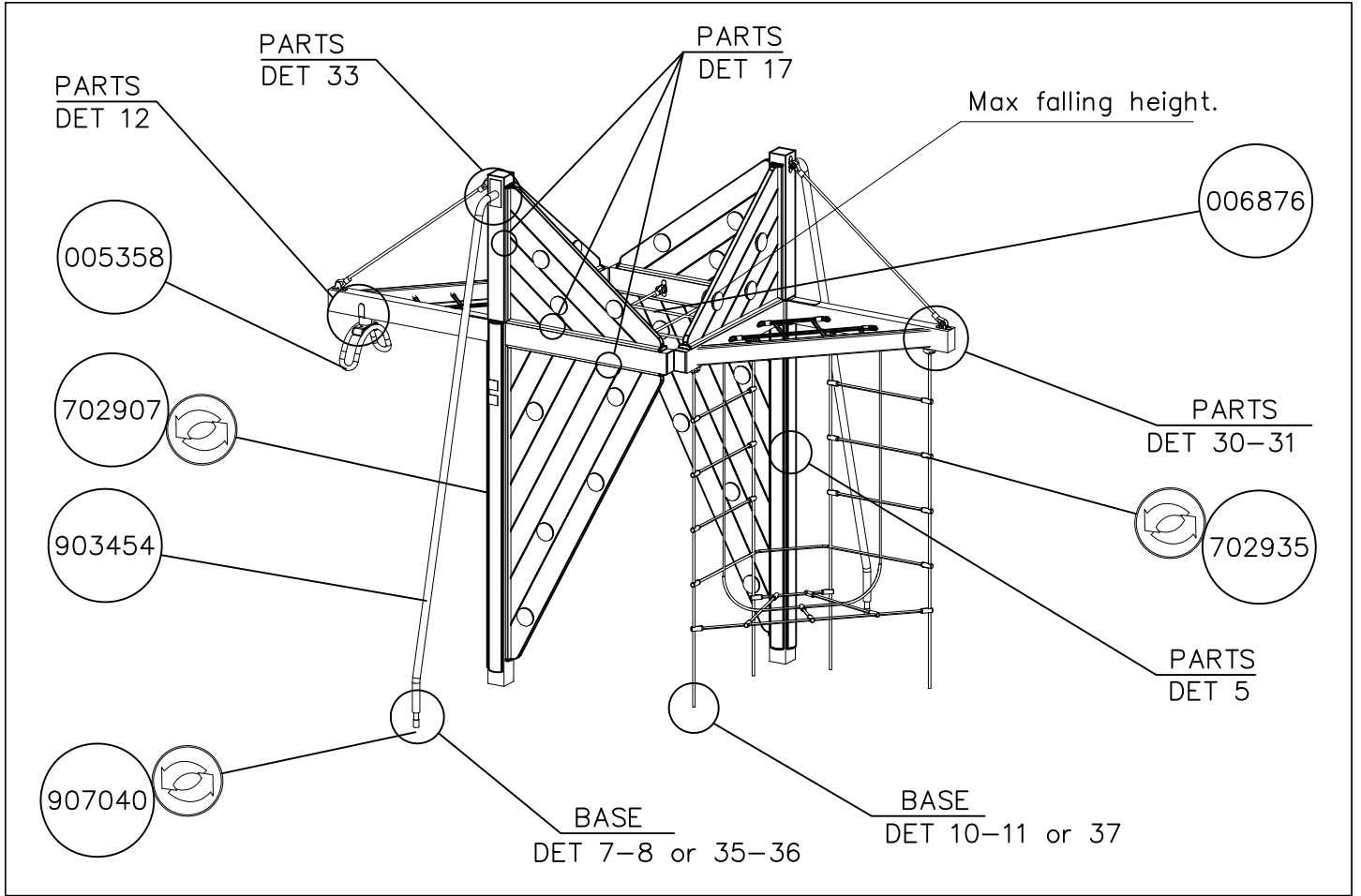



<p>DET 1</p>	<p>DET 2</p>	<p>DET 3</p>	<p>DET 4</p>
<p>DET 5</p>	<p>DET 6</p>	<p>DET 7</p>	<p>DET 8</p>
<p>DET 9</p>	<p>DET 10</p>	<p>DET 11</p>	<p>DET 12</p>
<p>DET 13</p>	<p>DET 14</p>	<p>DET 15</p>	<p>DET 16</p>
<p>DET 17</p>	<p>DET 18</p>	<p>DET 19</p>	<p>DET 20</p>



<p>DET 21</p> <p>M10</p>	<p>DET 22</p> <p>006884 6x60</p>	<p>DET 23</p> <p>8x70 905211</p>	<p>DET 24</p>
<p>DET 25</p> <p>905083 Ø16/8,4 8x100 905112</p>	<p>DET 27</p> <p>>Ø230mm >Ø230mm >Ø230mm >Ø230mm</p>	<p>DET 28</p>	
<p>DET 29</p> <p>70</p>	<p>DET 30</p> <p>8x70</p>	<p>DET 31</p> <p>370 370 70</p>	<p>DET 32</p> <p>400 400 400</p>
<p>DET 33</p> <p>8x70 15 903454</p>	<p>DET 34</p> <p>8x70</p>	<p>DET 35</p> <p>8x70</p>	<p>DET 36</p>
<p>DET 37</p> <p>660 660 660 660 660</p>	<p>DET 38</p> <p>1650 400 400</p>	<p>DET 39</p> <p>1650 500 500 500 500</p>	<p>DET 40</p>

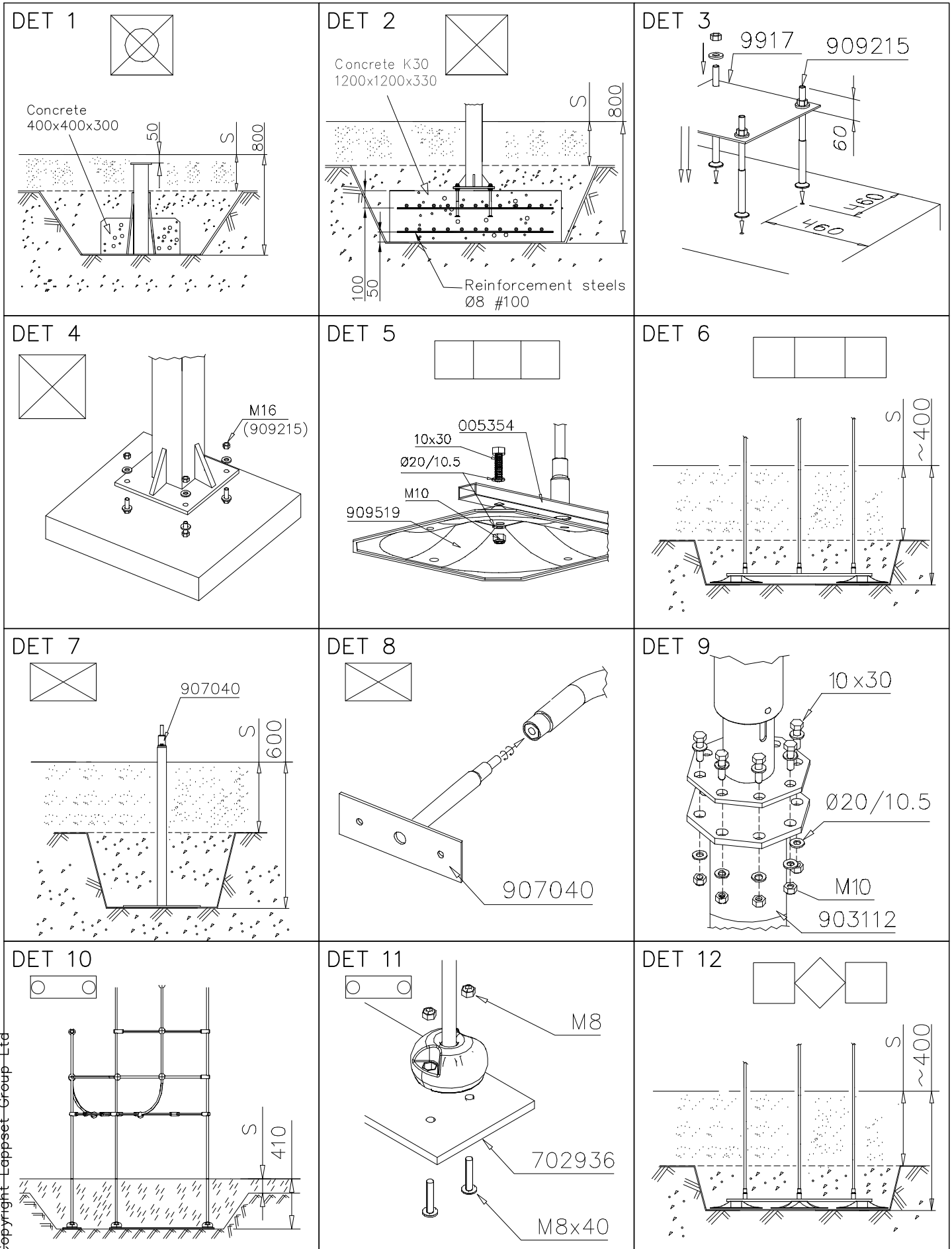

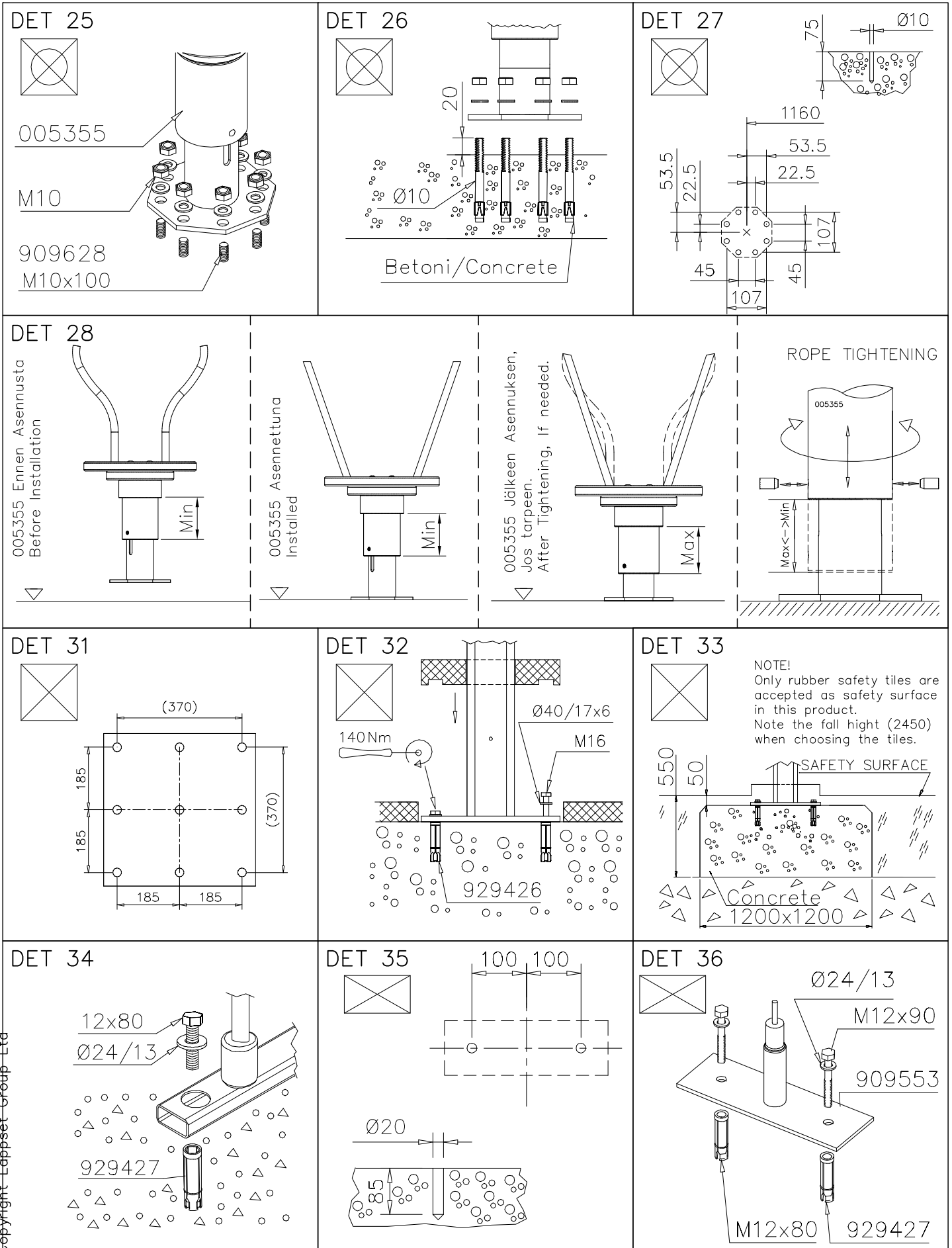



<p>DET 37</p>	<p>DET 38</p>	<p>DET 39</p>
<p>DET 40</p>	<p>DET 41</p>	<p>DET 42</p>
<p>DET 43</p>	<p>DET 44</p>	<p>DET 45</p>
<p>DET 46</p>	<p>DET 47</p>	<p>DET 48</p>

**Tuotekyltti tulee tuotteen mukana yhdellä seuraavista tavoista:****1) Metallinen tuotekyltti ja kiinnitysruuvit**

- Kiinnitä tuotekyltti ruuveilla tolppaan noin 2 metrin korkeuteen kuvan 1 mukaisesti.

2) Tuotekyltitarra

- Puhdista maalattu metalli- tai vaneripinta pölystä ja kosteudesta. Liimaa tarra kuvan 2 mukaisesti.
- Huom. Älä kiinnitä tarraa karheapintaiseen laminaattiin tai maalattuun puuhun.

Vår produktmärkning levereras på ett av följande sätt:**1) Produktskylt i metall**

- Fäst skylten med de medföljande skruvarna

2) Självhäftande produktetikett

- Rengör den pulverlackerade metallytan eller laminatyten så att den blir fri från smuts och fukt. Fäst etiketten enligt fig. 2.
- Obs! Fäst ej etiketten på detaljer med skrovlig yta eller på målat trä.

Product label is delivered by one of following ways:**1) Metal product label and screws**

- Fasten the label with screws.

2) Label sticker

- Clean the painted metal or plywood surface from dirt and moisture. Fasten the sticker as shown in the figure 2.
- Note. Do not attach the sticker to rough surfaced laminate or painted wood.

La plaque d'informations produit est livrée sous l'une de ces 3 formes :**1) Plaque métallique et vis**

- Fixez la plaque à l'aide des vis.

2) Etiquette autocollante

- Avant de coller l'étiquette, nettoyez le composant métallique peint ou la plaque de contreplaqué, de toute saleté. La surface doit être sèche (voir image 2).
- Attention, ne pas coller l'étiquette sur une surface lamellé-collée irrégulière ou sur du bois peint.

Die Auslieferung des Produktaufklebers erfolgt auf eine dieser Arten:**1) Produkt-Schild aus Metall incl. Schrauben**

- Die Befestigung des Schildes erfolgt mittels der Schrauben.

2) Aufkleber

- Entfernen Sie zunächst Schmutz und Feuchtigkeit vom lackierten Metall bzw. von der Holzoberfläche und bringen Sie den Aufkleber wie im Bild oben rechts beschrieben auf den gesäuberten Untergrund auf.
- Beachten Sie: Bringen Sie den Aufkleber nicht auf raues laminiertes oder lackiertes Holz an.