

# **LAPPSET®**









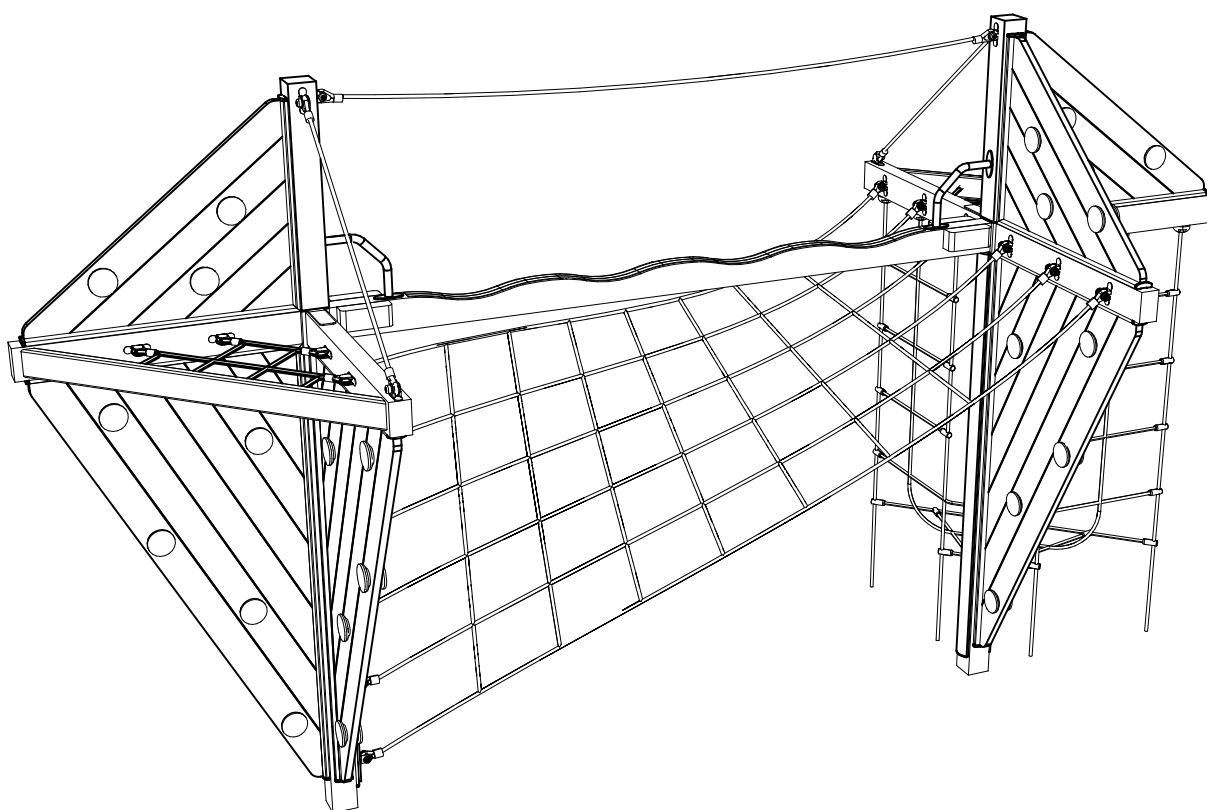

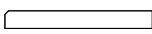
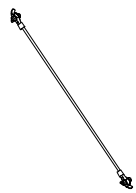

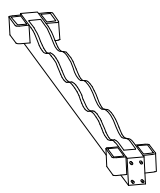
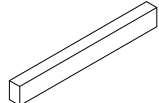
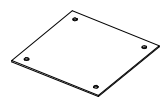
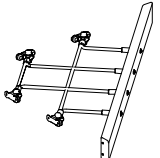

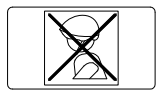



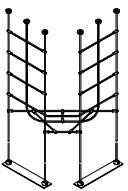
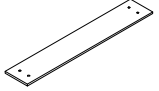
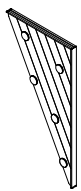
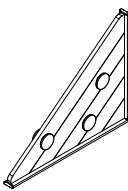

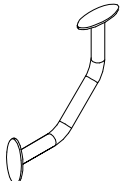
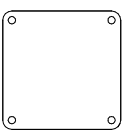

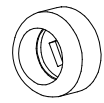
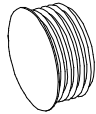

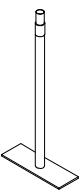
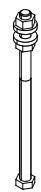
## **CLUB**

ASENNUSOHJE  
MONTERINGSANSVISNING  
INSTALLATION INSTRUCTION  
AUFBAUANLEITUNG  
NOTICE D'INSTALLATION

REF: 150210M  
DATE: 30.11.2015

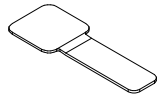
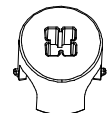
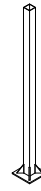
## **150210M**



005363	PCS 1		L 1200	006877	PCS 2		L 1420	006879	PCS 1		L 3340	006889	PCS 1		L 3300	006892	PCS 5		L 1200	009917	PCS 2		350x350	
700219	PCS 2		L 1670	702286	PCS 1		90x50	702339	PCS 1		90x50	702907	PCS 3		L 2200	702914	PCS 1		L 2350	702917	PCS 2		L 975	
702935	PCS 1		702935	702936	PCS 2		702936	707570	PCS 3		L 2135	707592	PCS 3		Seinä	707614	PCS 1		707614	900240	PCS 64		8x70	
901798	PCS 2		901798	902487	PCS 2		65x65	903454	PCS 1		L 3210	905051	PCS 16		Ø24/8.5	905083	PCS 8		Ø32	905103	PCS 16		PT-28/32-H	
905112	PCS 8		Ø22	907040	PCS 1		907040	909215	PCS 8		HPM 16x280	909233	PCS 8		8x100	909243	PCS 54		6x60	909506	PCS 8		Ø3.5x13	
909850	PCS 48		M8x25 RST	909851	PCS 16		8x55 RST	909876	PCS 8		M8x40	929341	PCS 2			960100	PCS 102		Ø20	960120	PCS 2		L 2900	
980107	PCS 8		6x60	980150	PCS 8		M8	980151	PCS 62		Ø16/8.4													

+ EN/AS Impact Area 52.7 m<sup>2</sup> +  
Grid size = 500 mm

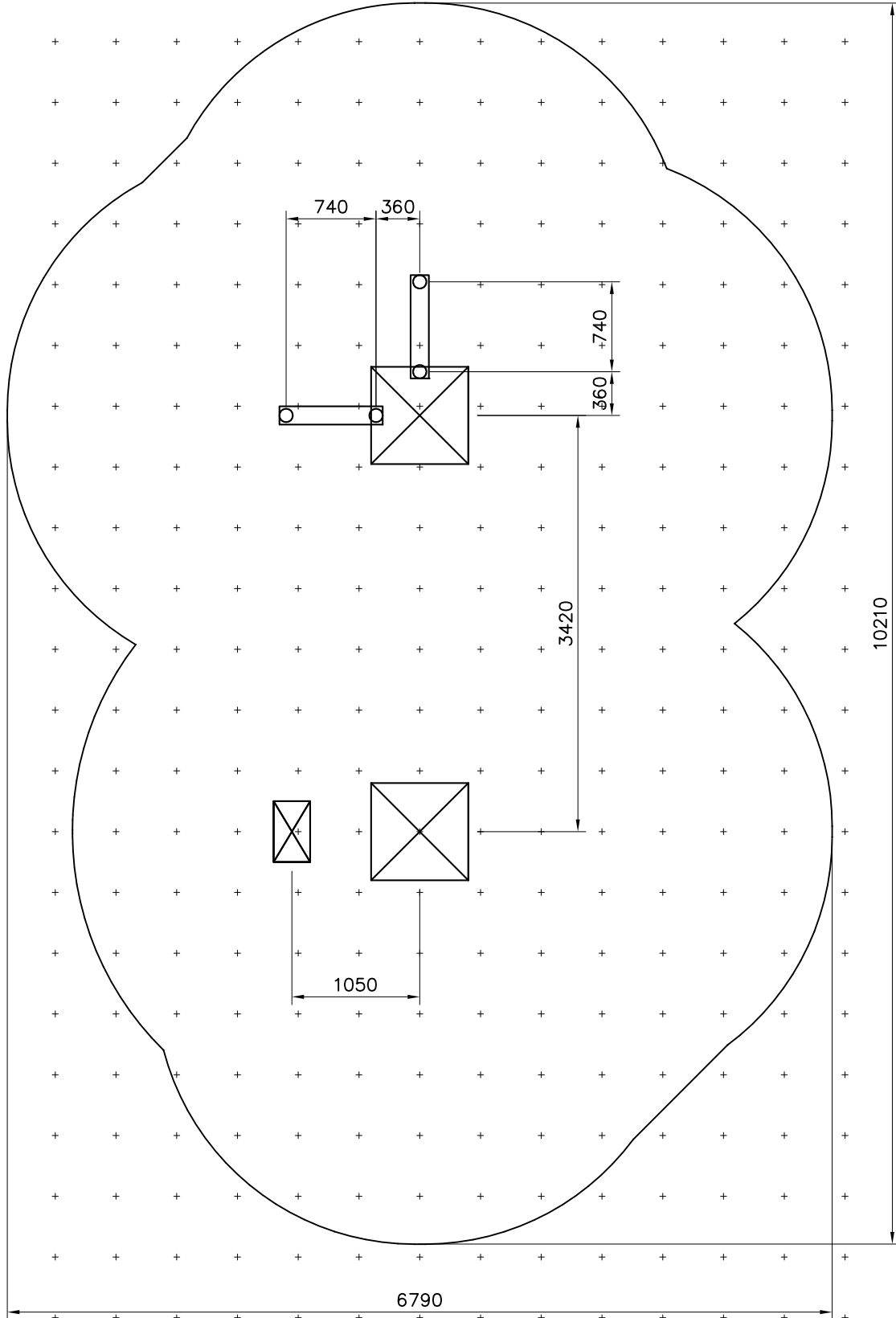
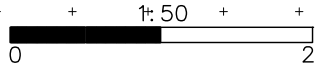

— EN/AS Impact Area 52.7 m<sup>2</sup>  
 - - - Falling Space 52.7 m<sup>2</sup>  
 Max Falling Height 2740 mm

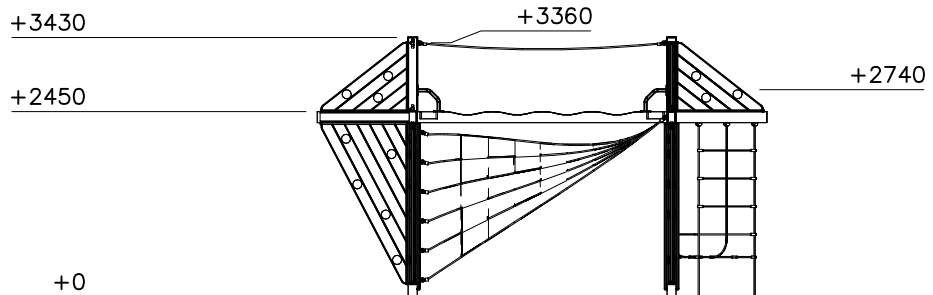
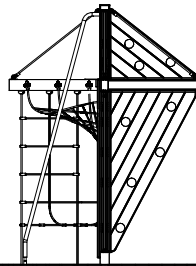
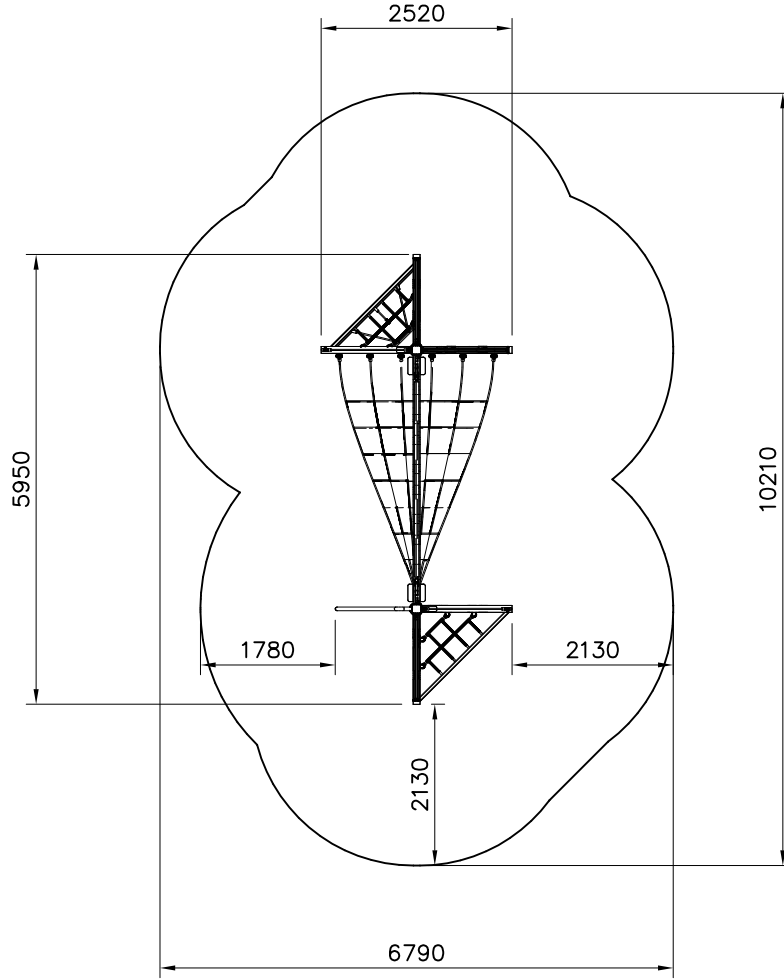
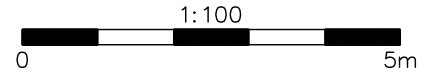

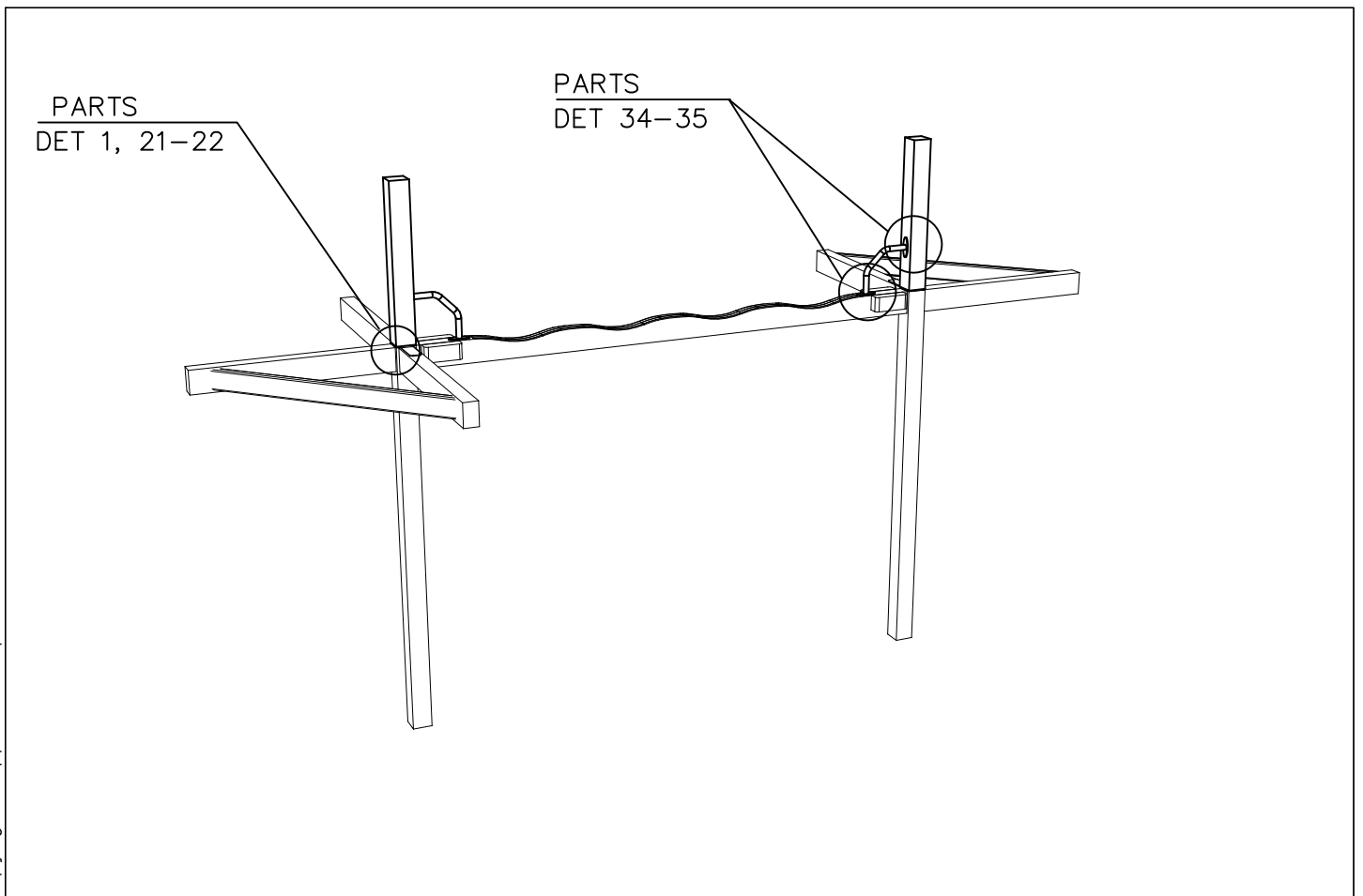
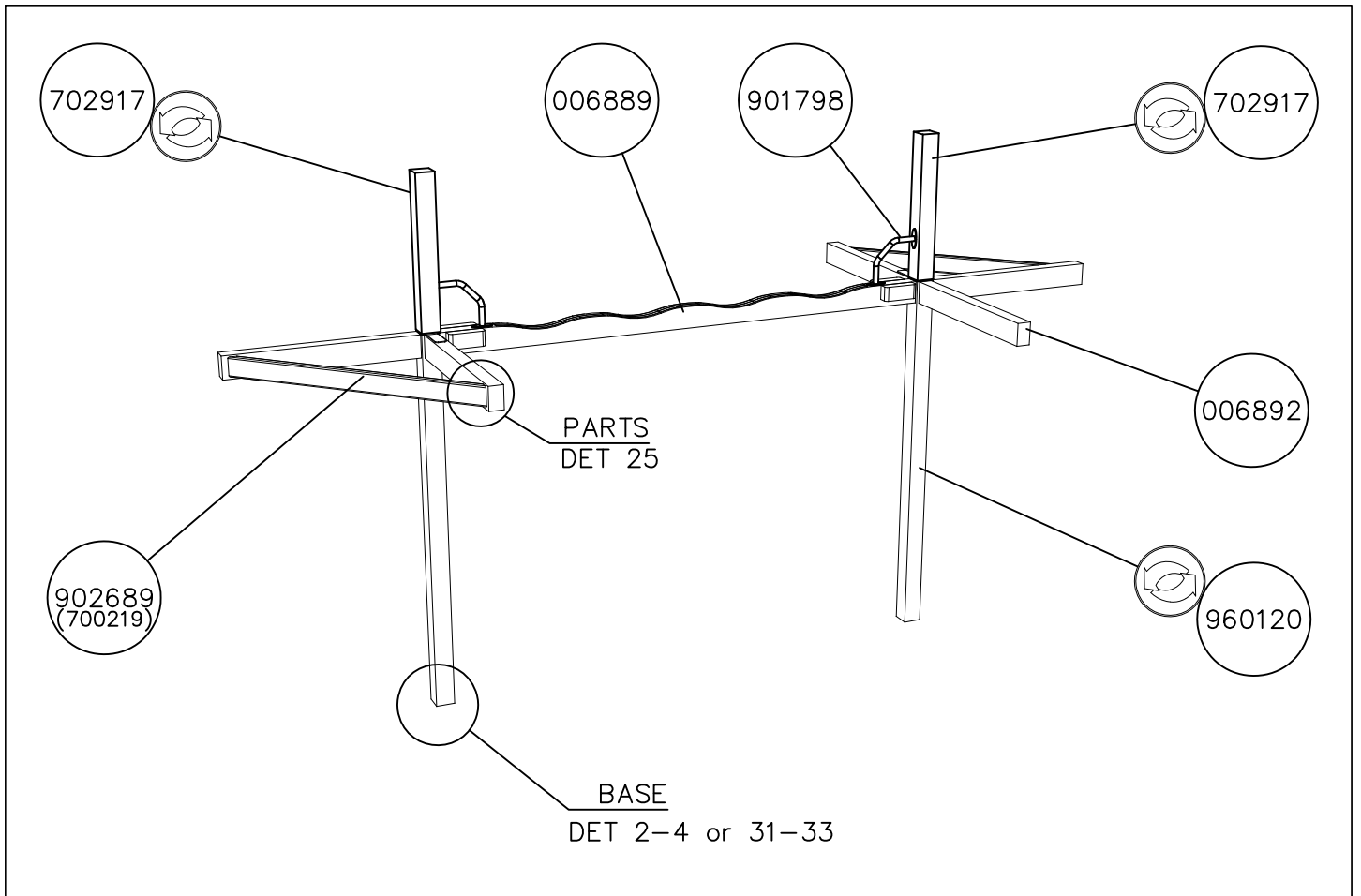

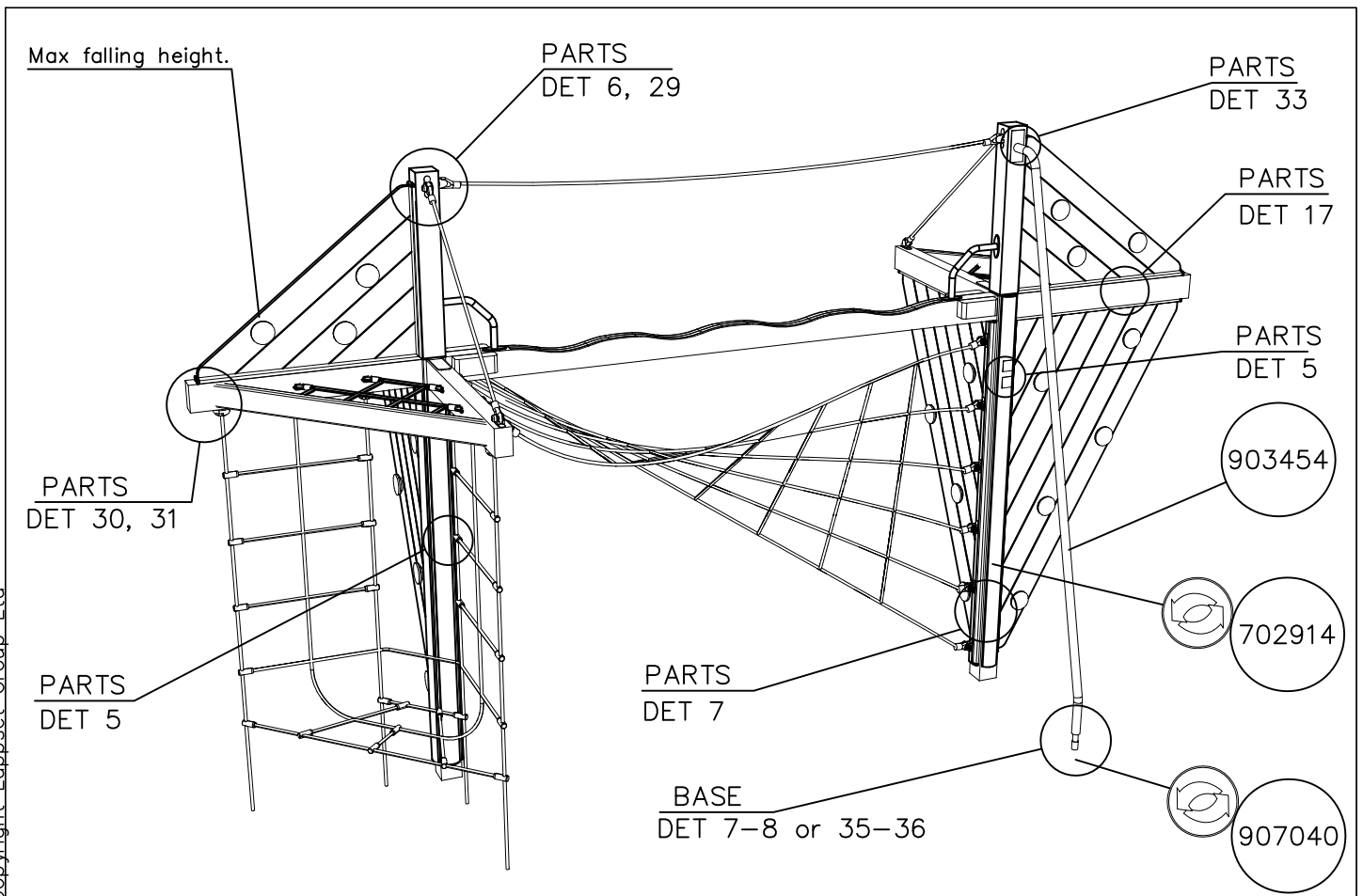
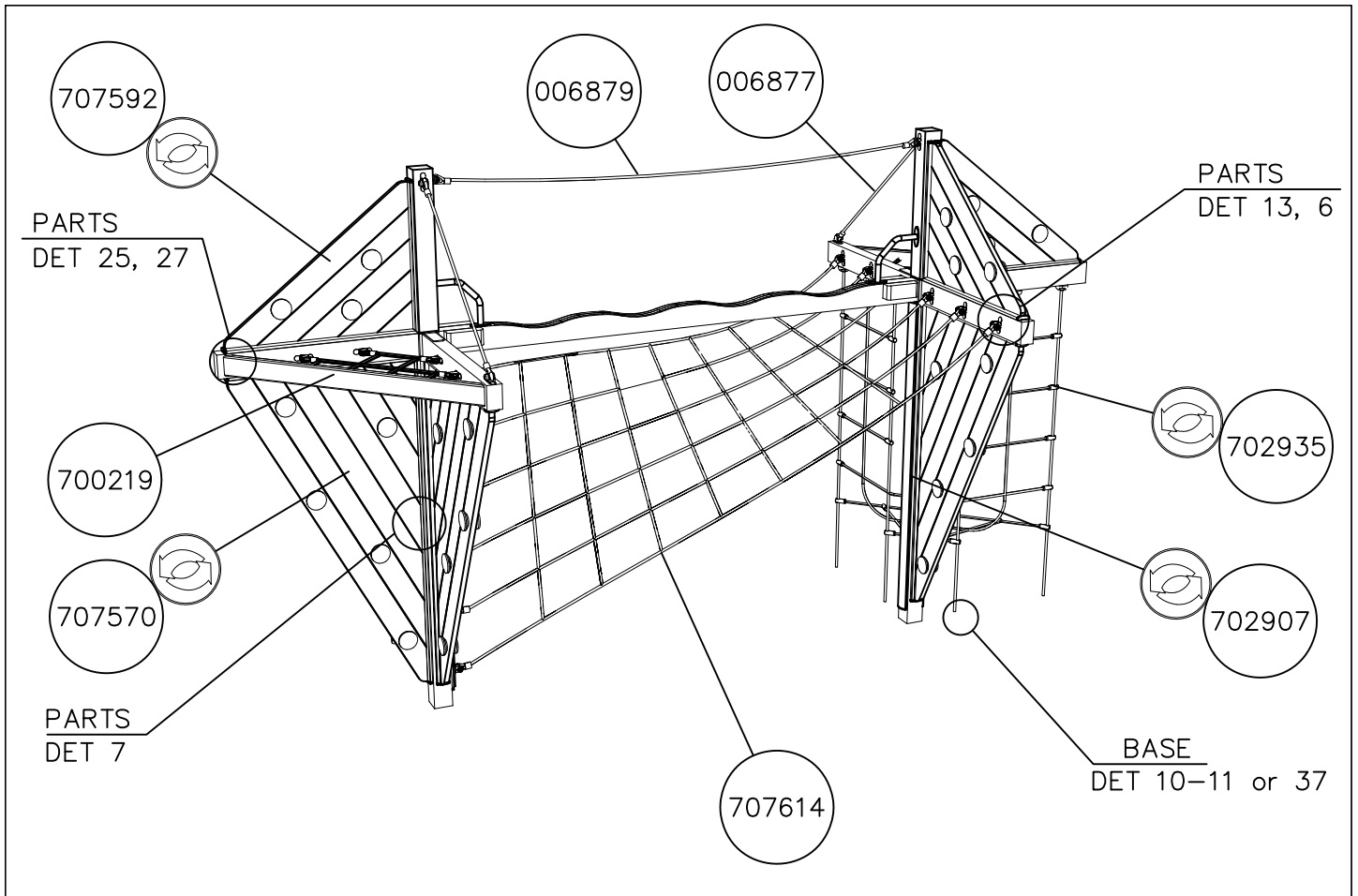



<p>DET 1</p>	<p>DET 2</p>	<p>DET 3</p>	<p>DET 4</p>
<p>DET 5</p>	<p>DET 6</p>	<p>DET 7</p>	<p>DET 8</p>
<p>DET 9</p>	<p>DET 10</p>	<p>DET 11</p>	<p>DET 12</p>
<p>DET 13</p>	<p>DET 14</p>	<p>DET 15</p>	<p>DET 16</p>
<p>DET 17</p>	<p>DET 18</p>	<p>DET 19</p>	<p>DET 20</p>



<p>DET 21</p> <p>M10</p>	<p>DET 22</p> <p>006884 6x60</p>	<p>DET 23</p> <p>8x70 905211</p>	<p>DET 24</p>
<p>DET 25</p> <p>905083 Ø16/8,4 8x100 905112</p>	<p>DET 27</p> <p>&gt;Ø230mm</p>	<p>DET 28</p>	
<p>DET 29</p> <p>70</p>	<p>DET 30</p> <p>8x70</p>	<p>DET 31</p> <p>370 370 70</p>	<p>DET 32</p> <p>400 400 400</p>
<p>DET 33</p> <p>8x70 15 903454</p>	<p>DET 34</p> <p>8x70</p>	<p>DET 35</p> <p>8x70</p>	<p>DET 36</p>
<p>DET 37</p> <p>660 660 660 660 660</p>	<p>DET 38</p> <p>1650 400 400</p>	<p>DET 39</p> <p>1650 500 500 500 500</p>	<p>DET 40</p>



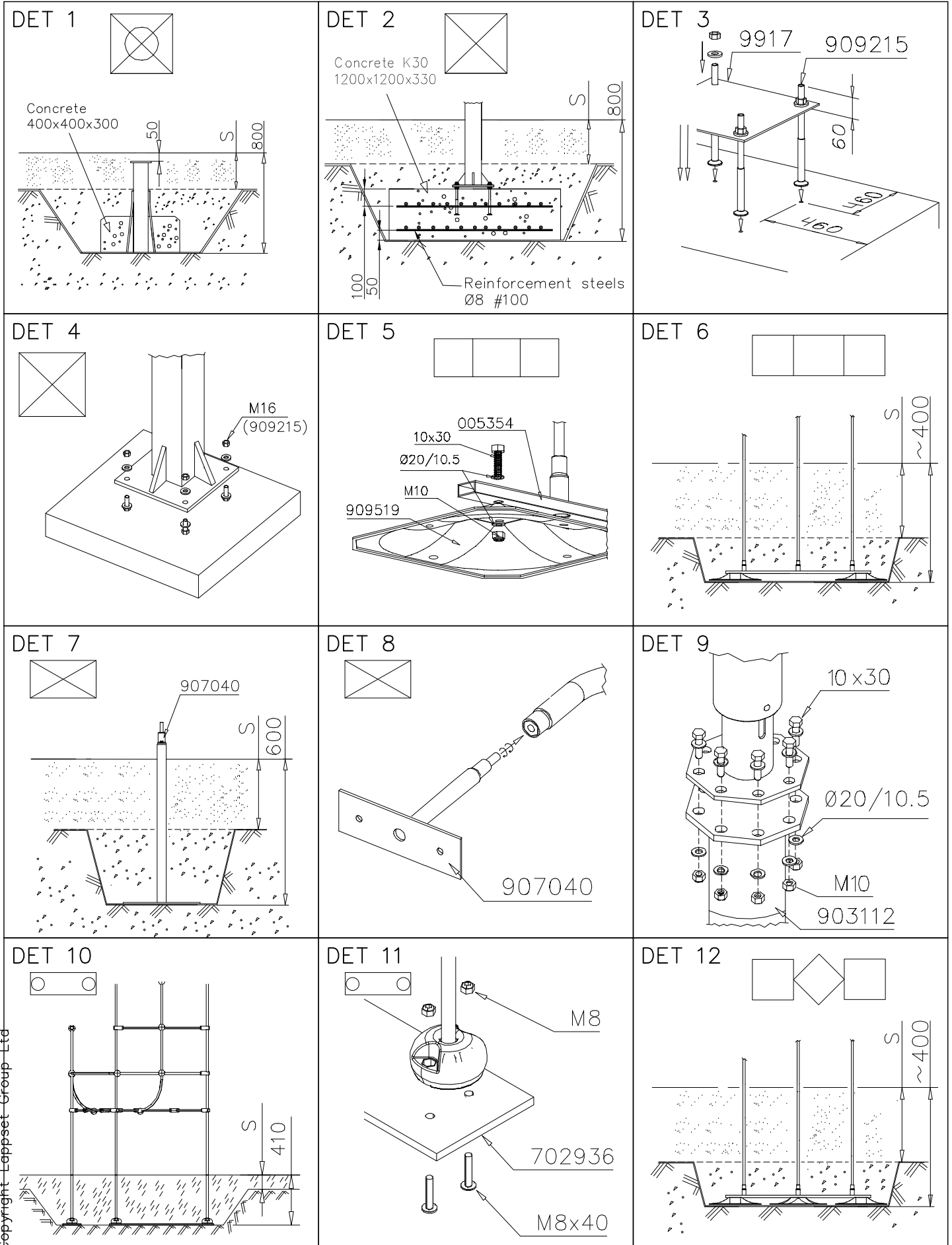

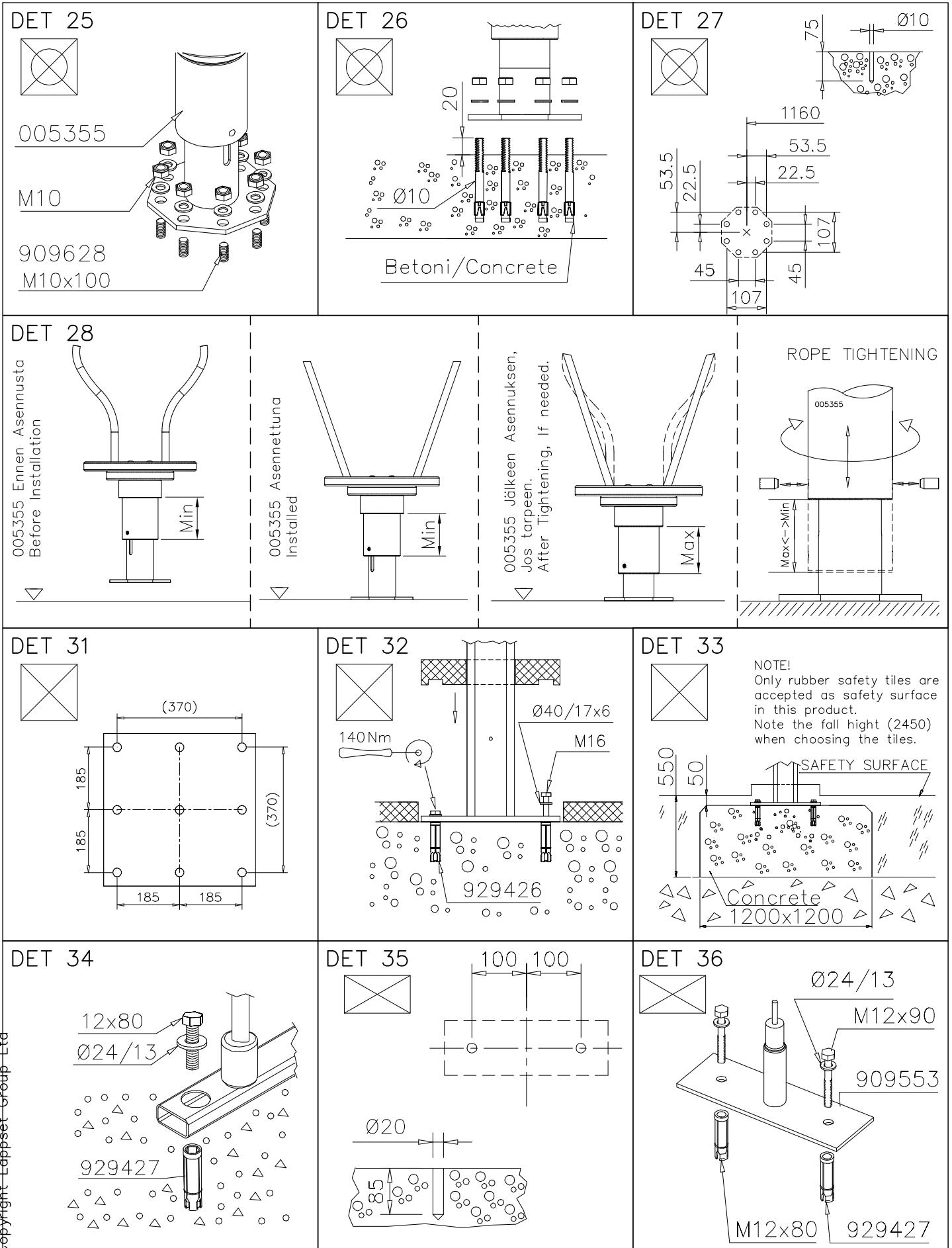



<p>DET 37</p>	<p>DET 38</p>	<p>DET 39</p>
<p>DET 40</p>	<p>DET 41</p>	<p>DET 42</p>
<p>DET 43</p>	<p>DET 44</p>	<p>DET 45</p>
<p>DET 46</p>	<p>DET 47</p>	<p>DET 48</p>

**Tuotekyltti tulee tuotteen mukana yhdellä seuraavista tavoista:****1) Metallinen tuotekyltti ja kiinnitysruuvit**

- Kiinnitä tuotekyltti ruuveilla tolppaan noin 2 metrin korkeuteen kuvan 1 mukaisesti.

**2) Tuotekylttitarra**

- Puhdista maalattu metalli- tai vaneripinta pölystä ja kosteudesta. Liimaa tarra kuvan 2 mukaisesti.
- Huom. Älä kiinnitä tarraa karheapintaiseen laminaattiin tai maalattuun puuhun.

**Vår produktmärkning levereras på ett av följande sätt:****1) Produktskylt i metall**

- Fäst skylten med de medföljande skruvarna

**2) Självhäftande produktetikett**

- Rengör den pulverlackerade metallytan eller laminatyten så att den blir fri från smuts och fukt. Fäst etiketten enligt fig. 2.
- Obs! Fäst ej etiketten på detaljer med skrovlig yta eller på målat trä.

**Product label is delivered by one of following ways:****1) Metal product label and screws**

- Fasten the label with screws.

**2) Label sticker**

- Clean the painted metal or plywood surface from dirt and moisture. Fasten the sticker as shown in the figure 2.
- Note. Do not attach the sticker to rough surfaced laminate or painted wood.

**La plaque d'informations produit est livrée sous l'une de ces 3 formes :****1) Plaque métallique et vis**

- Fixez la plaque à l'aide des vis.

**2) Etiquette autocollante**

- Avant de coller l'étiquette, nettoyez le composant métallique peint ou la plaque de contreplaqué, de toute saleté. La surface doit être sèche (voir image 2).
- Attention, ne pas coller l'étiquette sur une surface lamellé-collée irrégulière ou sur du bois peint.

**Die Auslieferung des Produktaufklebers erfolgt auf eine dieser Arten:****1) Produkt-Schild aus Metall incl. Schrauben**

- Die Befestigung des Schildes erfolgt mittels der Schrauben.

**2) Aufkleber**

- Entfernen Sie zunächst Schmutz und Feuchtigkeit vom lackierten Metall bzw. von der Holzoberfläche und bringen Sie den Aufkleber wie im Bild oben rechts beschrieben auf den gesäuberten Untergrund auf.
- Beachten Sie: Bringen Sie den Aufkleber nicht auf raues laminiertes oder lackiertes Holz an.