

# **LAPPSET®**









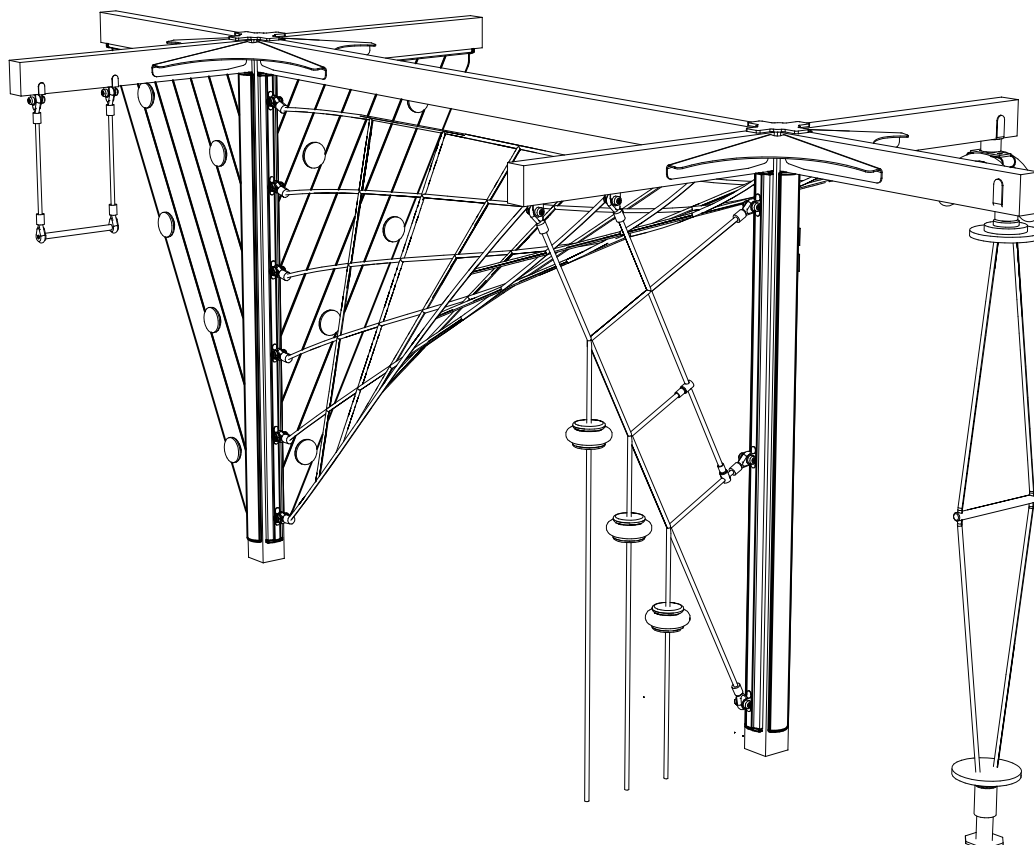

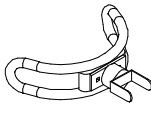
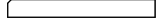
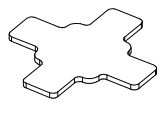
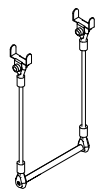
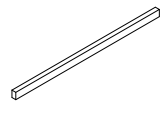
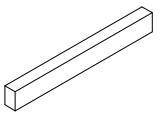
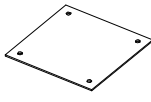

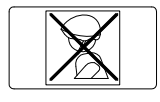

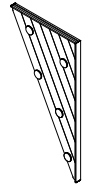
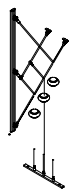

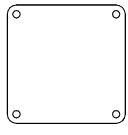

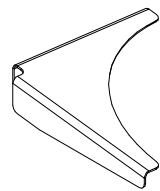

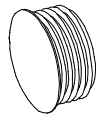
## **CLUB**

ASENNUSOHJE  
MONTERINGSANSVISNING  
INSTALLATION INSTRUCTION  
AUFBAUANLEITUNG  
NOTICE D'INSTALLATION

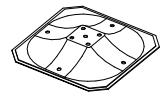
REF: 150200M  
DATE: 30.11.2015

## **150200M**

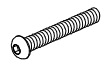
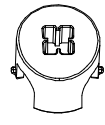
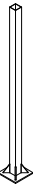
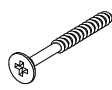

005355 	PCS 1	005358 	PCS 1	005363 	PCS 1	005365 	PCS 2	006870 	PCS 1	006886 	PCS 1
				L 1200						L 3300	
006892 	PCS 6	009917 	PCS 2	702286 	PCS 1	702339 	PCS 1	702907 	PCS 4	707570 	PCS 2
L 1200		350x350		90x50		90x50		L 2200		L 2135	
707613 	PCS 1	707614 	PCS 1	900240 	PCS 104	902487 	PCS 2	903112 	PCS 1	903435 	PCS 6
				8x70		65x65		L 750			
905051 	PCS 16	905103 	PCS 16	909215 	PCS 8	909243 	PCS 12	909506 	PCS 8	909519 	PCS 2
Ø24/8.5		PT-28/32-H		HPM 16x280		6x60		Ø3.5x13			
909629 	PCS 10	909637 	PCS 10	909638 	PCS 20	909850 	PCS 48	909851 	PCS 16	960100 	PCS 60
10x30		M10		Ø20/10.5		M8x25 RST		8x55 RST		Ø20	
960120 	PCS 2	980107 	PCS 8	980151 	PCS 12						
L 2900		6x60		Ø16/8.4							
	PCS		PCS		PCS		PCS		PCS		PCS

EN/AS Impact Area 54.3 m<sup>2</sup>  
Grid Size = 500 mm

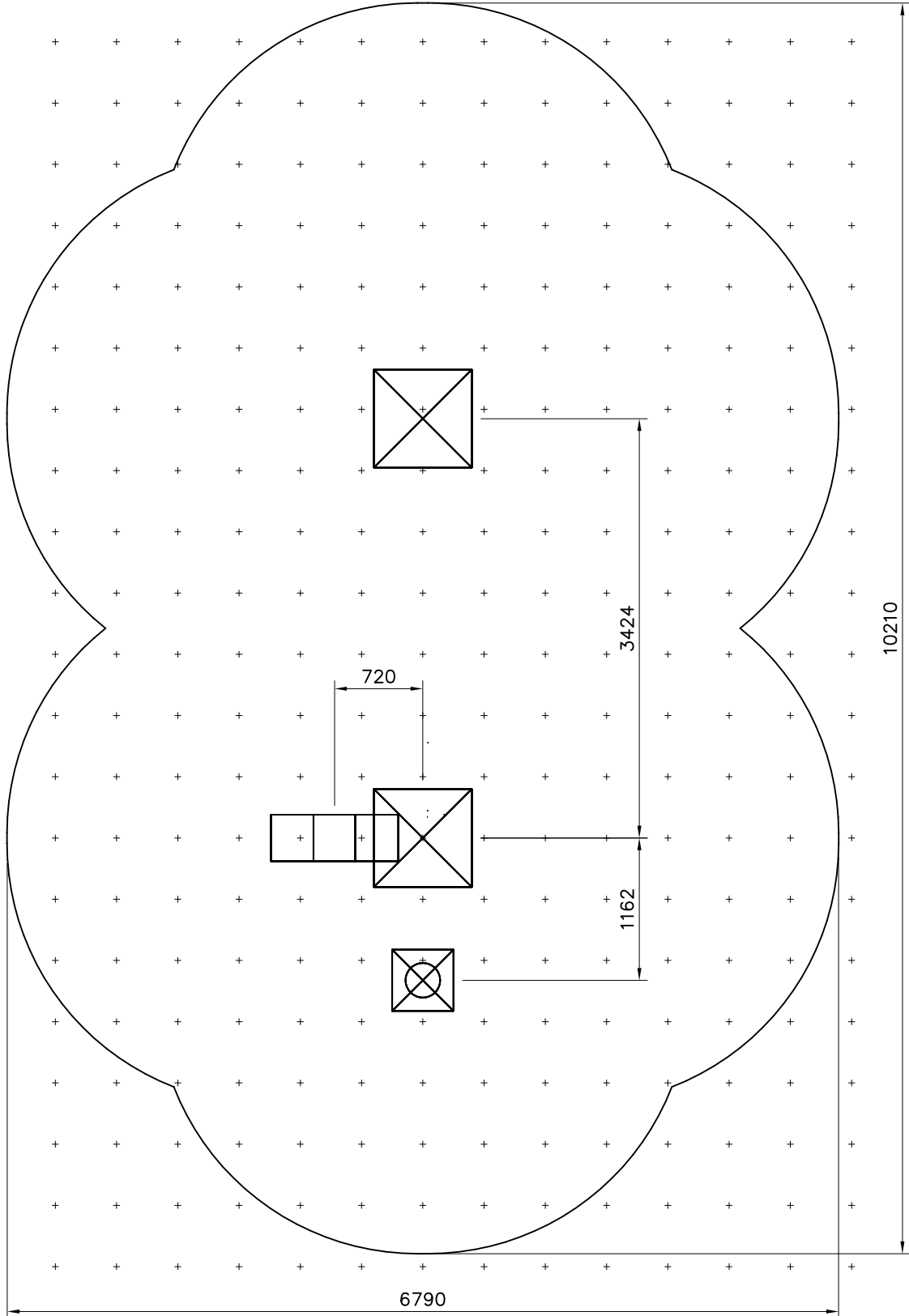
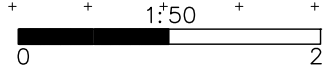

— EN/AS Impact Area 54.3 m<sup>2</sup>  
- - - Falling Space 54.3 m<sup>2</sup>  
Max falling height 2450 mm.

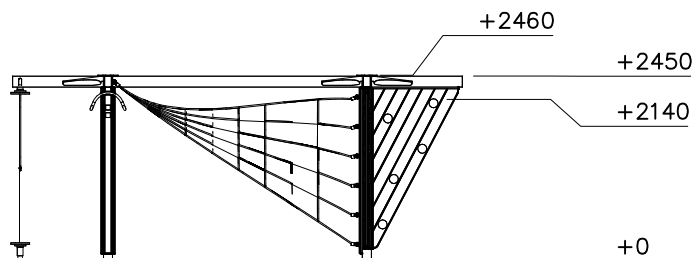
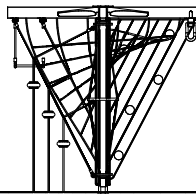
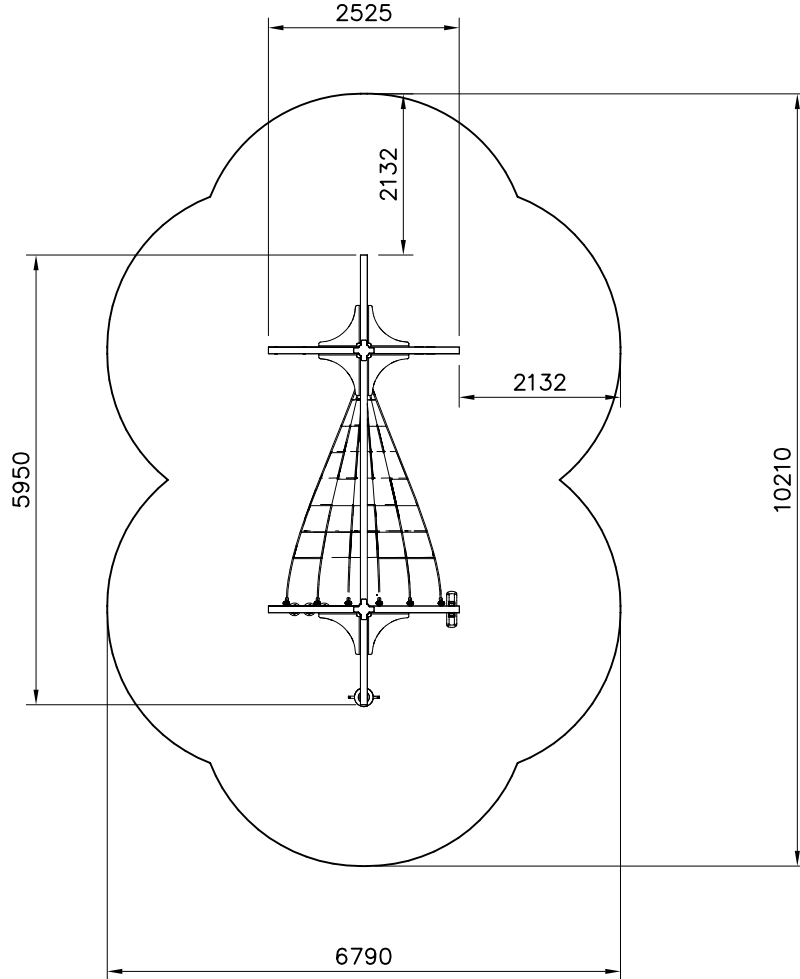
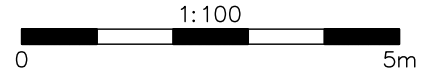

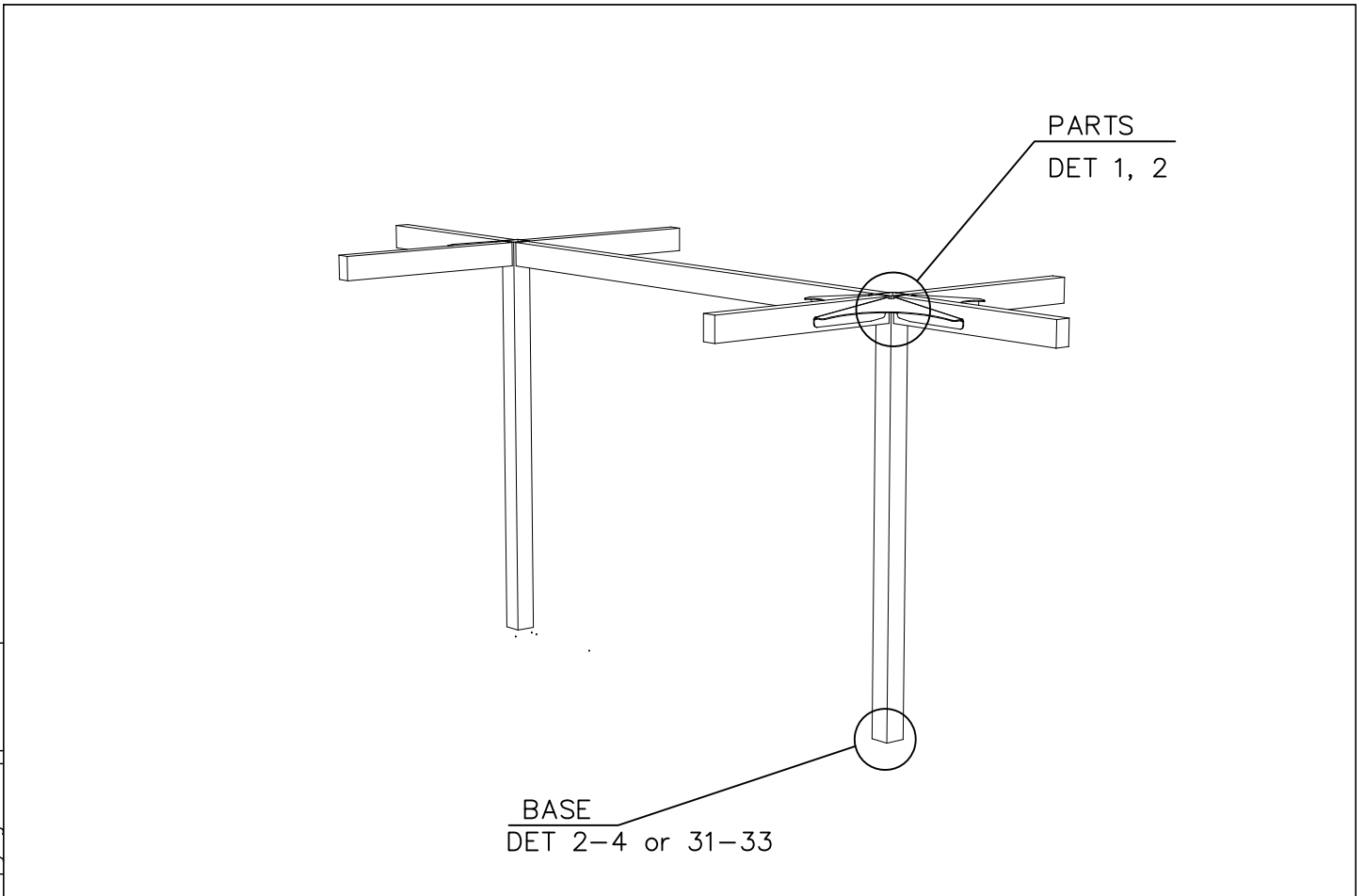
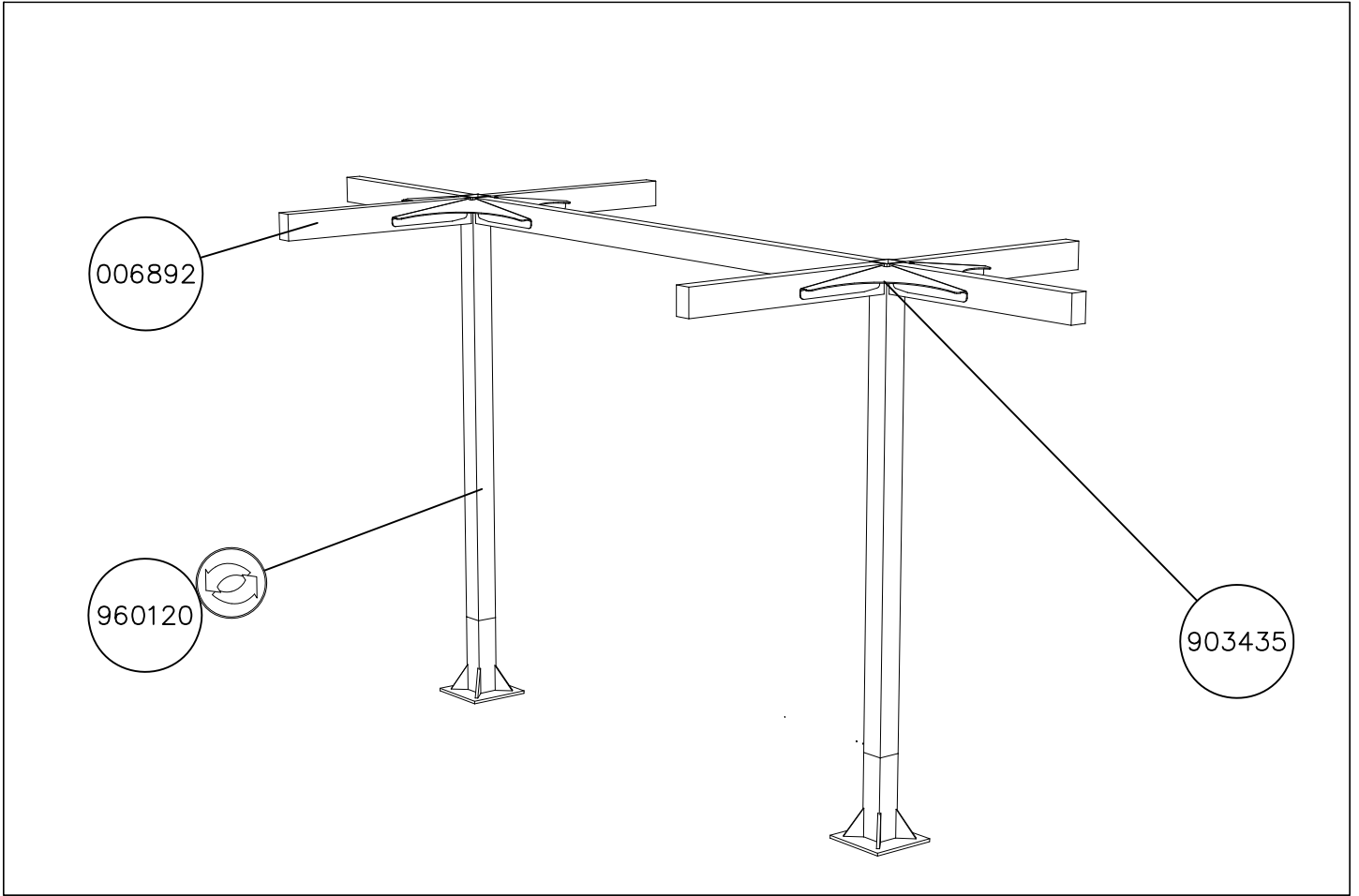

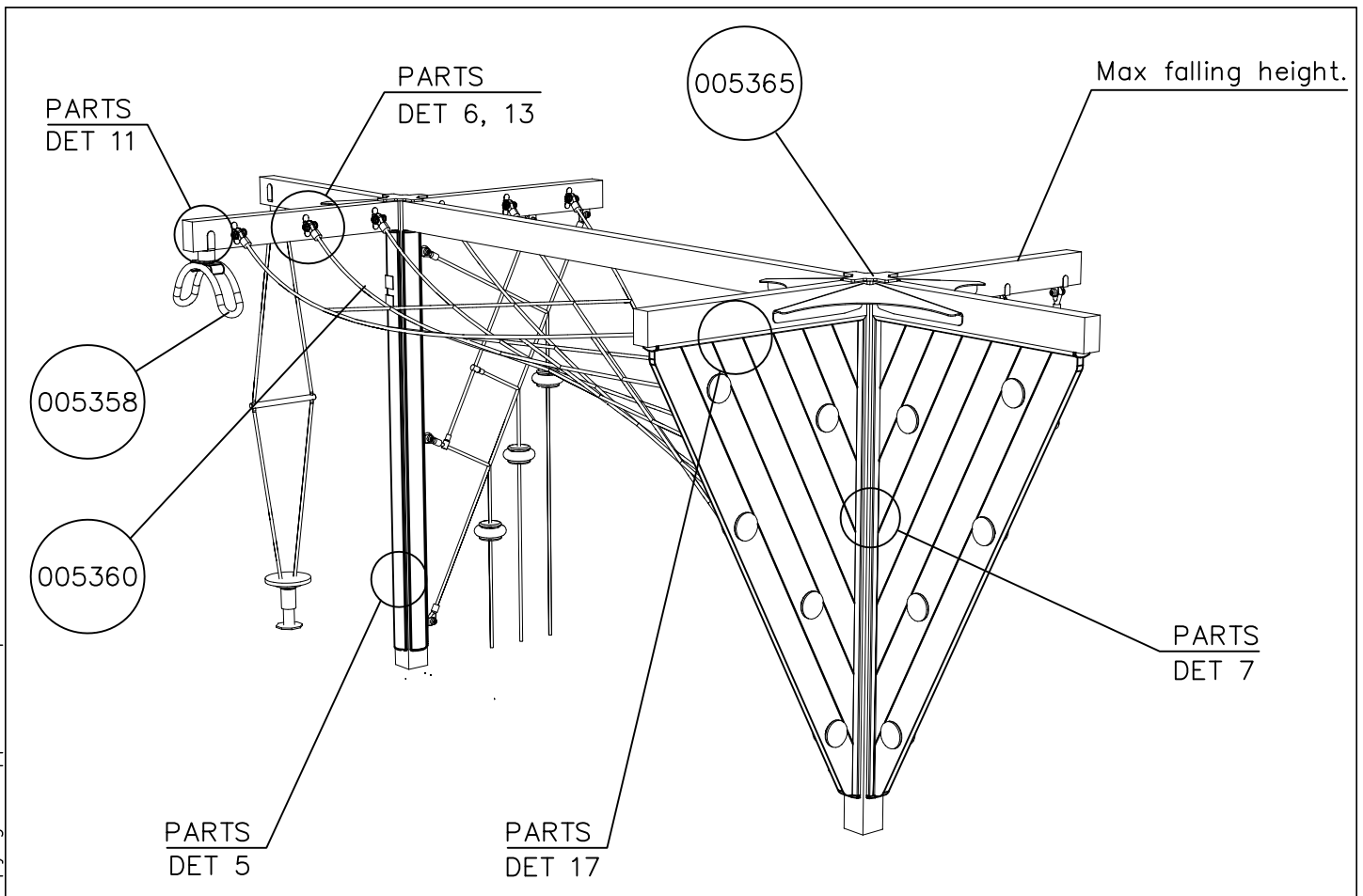
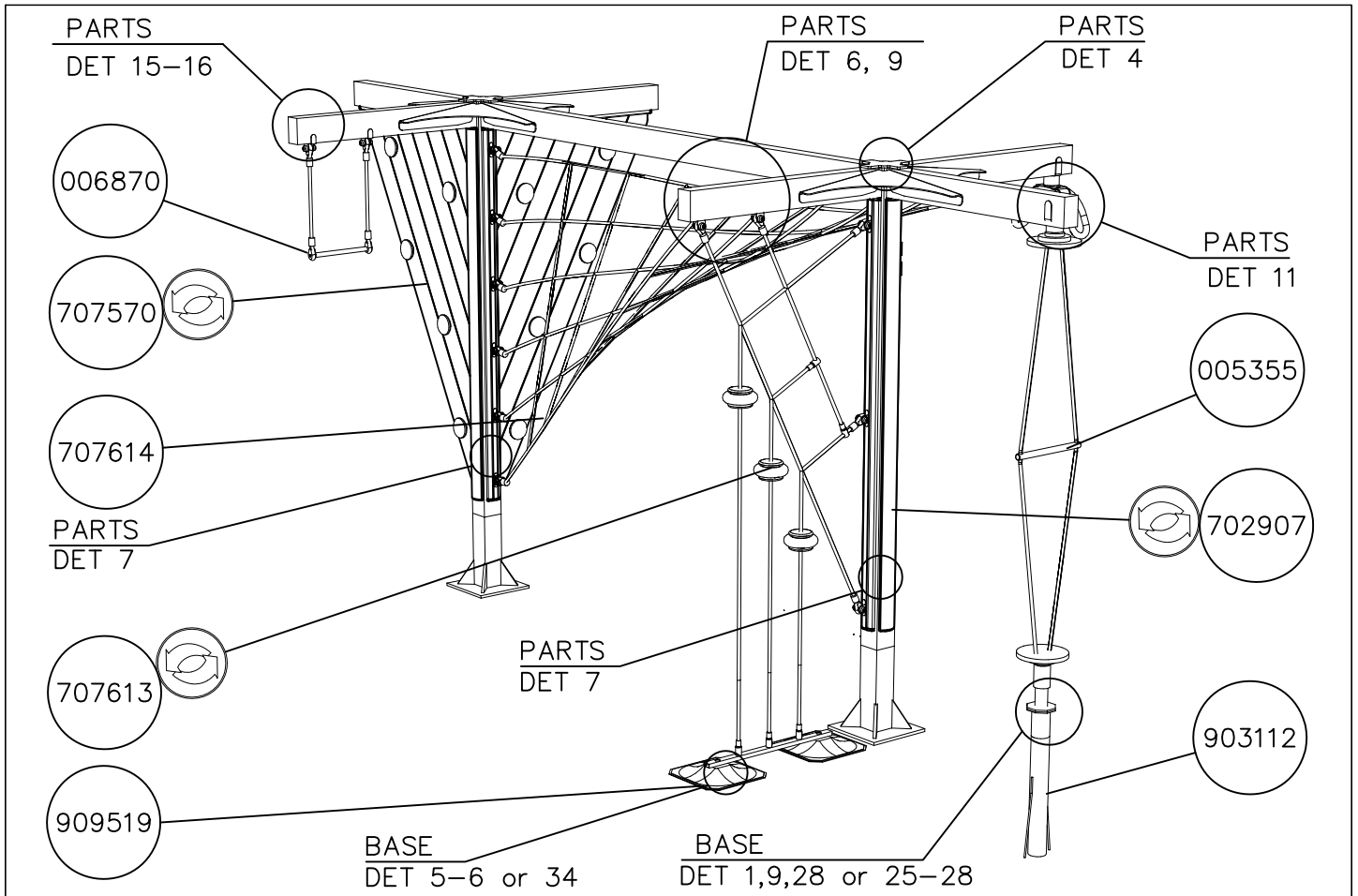



<p>DET 1</p>	<p>DET 2</p>	<p>DET 3</p>	<p>DET 4</p>
<p>DET 5</p>	<p>DET 6</p>	<p>DET 7</p>	<p>DET 8</p>
<p>DET 9</p>	<p>DET 10</p>	<p>DET 11</p>	<p>DET 12</p>
<p>DET 13</p>	<p>DET 14</p>	<p>DET 15</p>	<p>DET 16</p>
<p>DET 17</p>	<p>DET 18</p>	<p>DET 19</p>	<p>DET 20</p>



<p>DET 21</p> <p>M10</p>	<p>DET 22</p> <p>006884 6x60</p>	<p>DET 23</p> <p>8x70 905211</p>	<p>DET 24</p>
<p>DET 25</p> <p>905083 Ø16/8,4 8x100 905112</p>	<p>DET 27</p> <p>&gt;Ø230mm &gt;Ø230mm &gt;Ø230mm &gt;Ø230mm</p>	<p>DET 28</p>	
<p>DET 29</p> <p>70</p>	<p>DET 30</p> <p>8x70</p>	<p>DET 31</p> <p>370 370 70</p>	<p>DET 32</p> <p>400 400 400</p>
<p>DET 33</p> <p>8x70 903454</p>	<p>DET 34</p> <p>8x70</p>	<p>DET 35</p> <p>8x70</p>	<p>DET 36</p>
<p>DET 37</p> <p>660 660 660 660 660</p>	<p>DET 38</p> <p>1650 400 400</p>	<p>DET 39</p> <p>1650 500 500 500 500</p>	<p>DET 40</p>



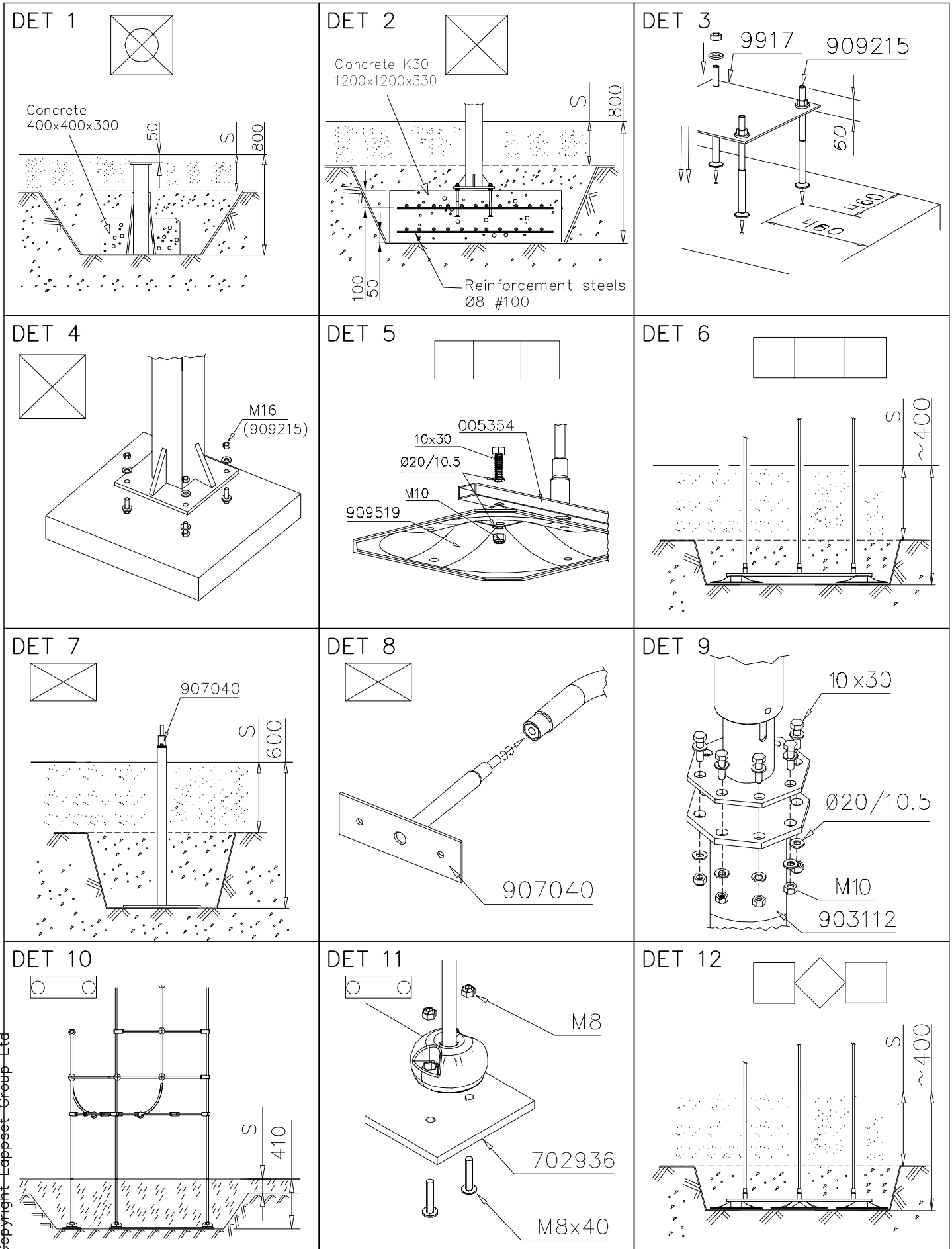

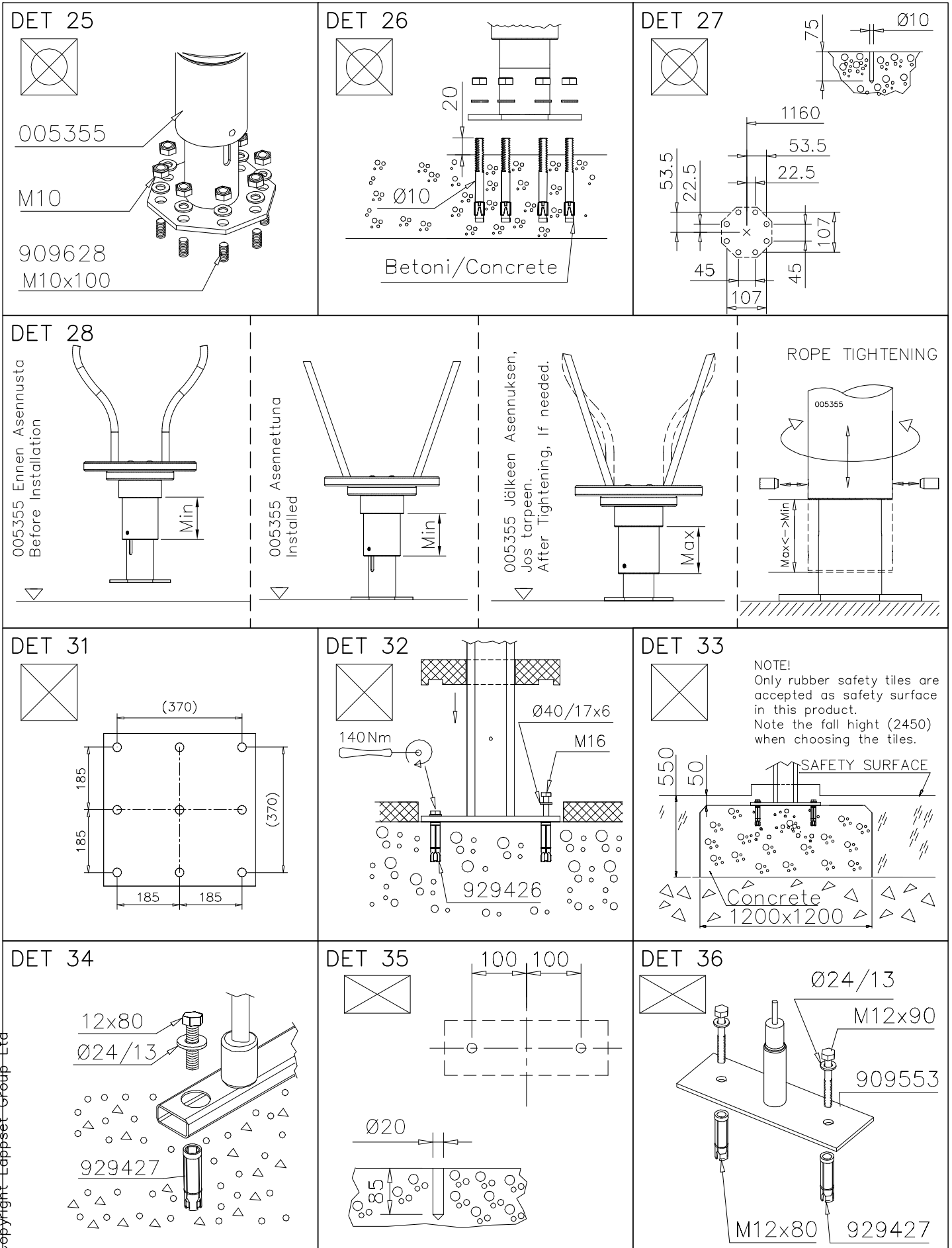



<p>DET 37</p>	<p>DET 38</p>	<p>DET 39</p>
<p>DET 40</p>	<p>DET 41</p>	<p>DET 42</p>
<p>DET 43</p>	<p>DET 44</p>	<p>DET 45</p>
<p>DET 46</p>	<p>DET 47</p>	<p>DET 48</p>



**Tuotekyltti tulee tuotteen mukana yhdellä seuraavista tavoista:**

**1) Metallinen tuotekyltti ja kiinnitysruuvit**

- Kiinnitä tuotekyltti ruuveilla tolppaan noin 2 metrin korkeuteen kuvan 1 mukaisesti.

**2) Tuotekylttitarra**

- Puhdista maalattu metalli- tai vaneripinta pölystä ja kosteudesta. Liimaa tarra kuvan 2 mukaisesti.
- Huom. Älä kiinnitä tarraa karheapintaiseen laminaattiin tai maalattuun puuhun.

**Vår produktmärkning levereras på ett av följande sätt:**

**1) Produktskylt i metall**

- Fäst skylten med de medföljande skruvarna

**2) Självhäftande produktetikett**

- Rengör den pulverlackerade metallytan eller laminatyten så att den blir fri från smuts och fukt. Fäst etiketten enligt fig. 2.
- Obs! Fäst ej etiketten på detaljer med skrovlig yta eller på målat trä.

**Product label is delivered by one of following ways:**

**1) Metal product label and screws**

- Fasten the label with screws.

**2) Label sticker**

- Clean the painted metal or plywood surface from dirt and moisture. Fasten the sticker as shown in the figure 2.
- Note. Do not attach the sticker to rough surfaced laminate or painted wood.

**La plaque d'informations produit est livrée sous l'une de ces 3 formes :**

**1) Plaque métallique et vis**

- Fixez la plaque à l'aide des vis.

**2) Etiquette autocollante**

- Avant de coller l'étiquette, nettoyez le composant métallique peint ou la plaque de contreplaqué, de toute saleté. La surface doit être sèche (voir image 2).
- Attention, ne pas coller l'étiquette sur une surface lamellé-collée irrégulière ou sur du bois peint.

**Die Auslieferung des Produktaufklebers erfolgt auf eine dieser Arten:**

**1) Produkt-Schild aus Metall incl. Schrauben**

- Die Befestigung des Schildes erfolgt mittels der Schrauben.

**2) Aufkleber**

- Entfernen Sie zunächst Schmutz und Feuchtigkeit vom lackierten Metall bzw. von der Holzoberfläche und bringen Sie den Aufkleber wie im Bild oben rechts beschrieben auf den gesäuberten Untergrund auf.
- Beachten Sie: Bringen Sie den Aufkleber nicht auf raues laminiertes oder lackiertes Holz an.