

# **LAPPSET®**

## **CLUB**

ASENNUSOHJE  
MONTERINGSANSVISNING  
INSTALLATION INSTRUCTION  
AUFBAUANLEITUNG  
NOTICE D'INSTALLATION

REF: 150102M  
DATE: 23.4.2009

## **150102M**

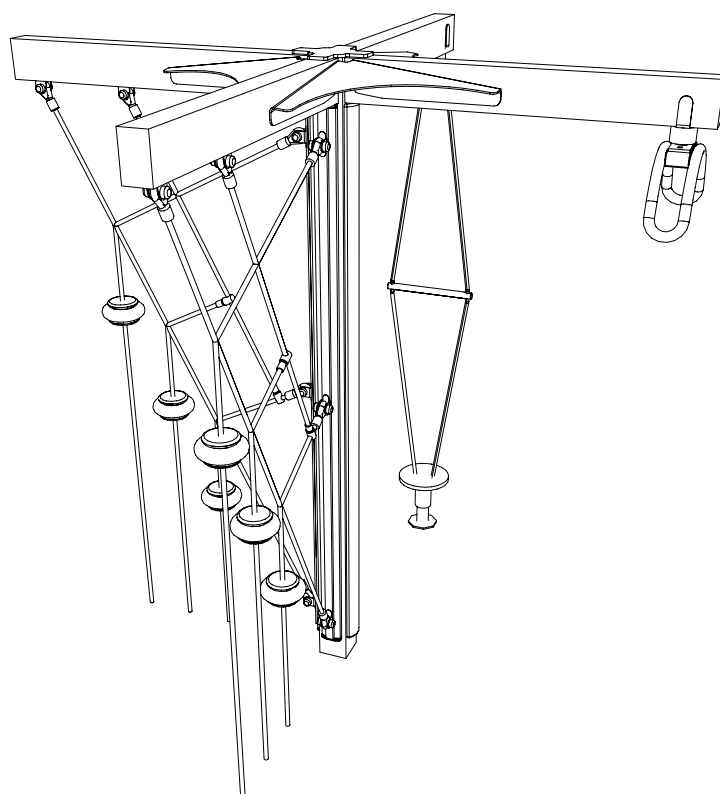

|         |          |            |           |        |           |          |           |            |           |            |          |
|---------|----------|------------|-----------|--------|-----------|----------|-----------|------------|-----------|------------|----------|
| 005354  | PCS<br>2 | 005355     | PCS<br>1  | 005358 | PCS<br>1  | 005365   | PCS<br>1  | 006860     | PCS<br>2  | 006892     | PCS<br>4 |
|         |          |            |           |        |           |          |           |            |           |            |          |
|         |          |            |           |        |           |          |           | L 2200     |           | L 1200     |          |
| 009917  | PCS<br>1 | 900240     | PCS<br>68 | 903112 | PCS<br>1  | 905051   | PCS<br>8  | 905103     | PCS<br>8  | 909215     | PCS<br>4 |
|         |          |            |           |        |           |          |           |            |           |            |          |
| 350x350 |          | 8x70       |           | L 750  |           | Ø24/8.5  |           | PT-28/32-H |           | HPM 16x280 |          |
| 909519  | PCS<br>4 | 909629     | PCS<br>12 | 909637 | PCS<br>12 | 909638   | PCS<br>24 | 909850     | PCS<br>24 | 909851     | PCS<br>8 |
|         |          |            |           |        |           |          |           |            |           |            |          |
|         |          | M10x30     |           | M10    |           | Ø20/10.5 |           | M8x25 RST  |           | M8x55 RST  |          |
| 903435  | PCS<br>4 | 960100     | PCS<br>24 | 960120 | PCS<br>1  | 980107   | PCS<br>4  | 702286     | PCS<br>1  | 702339     | PCS<br>1 |
|         |          |            |           |        |           |          |           |            |           |            |          |
|         |          | Ø20        |           | L 2900 |           | Ø6x60    |           | 90x50      |           | 90x50      |          |
| 902487  | PCS<br>2 | 909506     | PCS<br>8  |        | PCS       |          | PCS       |            | PCS       |            | PCS      |
|         |          |            |           |        |           |          |           |            |           |            |          |
| 65x65   |          | Ø3.5x13 A2 |           |        |           |          |           |            |           |            |          |
|         | PCS      |            | PCS       |        | PCS       |          | PCS       |            | PCS       |            | PCS      |
|         |          |            |           |        |           |          |           |            |           |            |          |
|         | PCS      |            | PCS       |        | PCS       |          | PCS       |            | PCS       |            | PCS      |
|         |          |            |           |        |           |          |           |            |           |            |          |

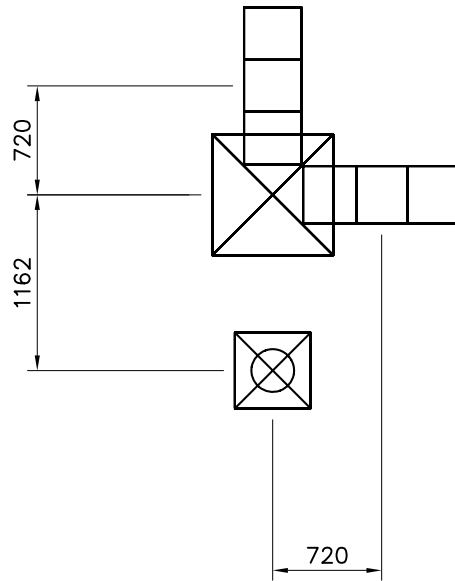
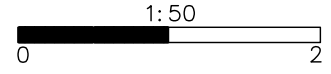

EN Impact Area 32.7 m<sup>2</sup>  
Max falling height 2450 mm.

