

# **LAPPSET®**



## **CLOXX**

ASENNUSOHJE  
MONTERINGSANSVISNING  
INSTALLATION INSTRUCTION  
AUFBAUANLEITUNG  
NOTICE D'INSTALLATION

REF: 220110  
DATE: 18.2.2015

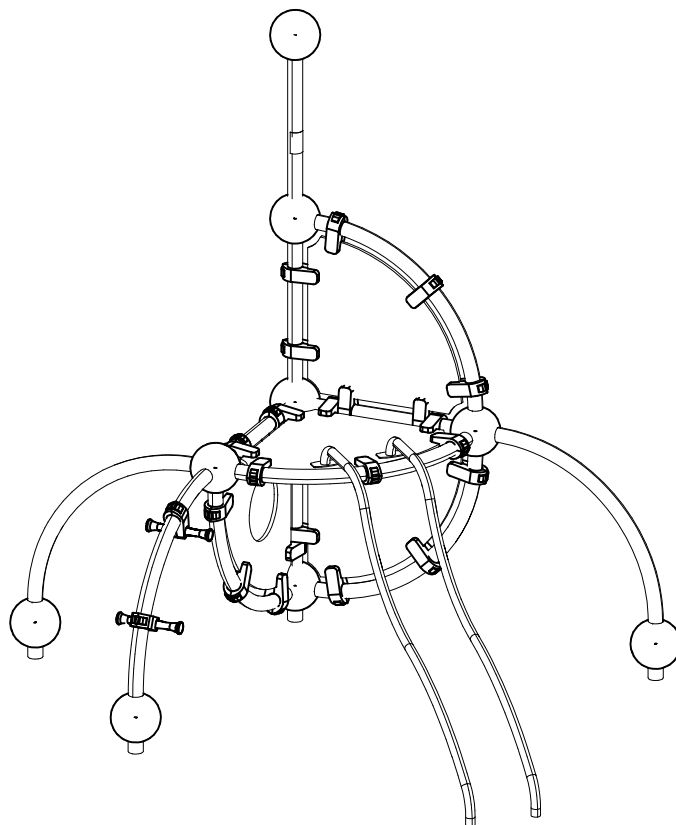
## **220110**

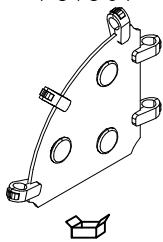
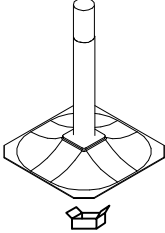
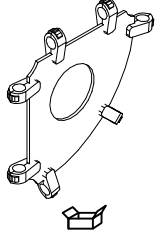
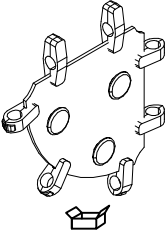
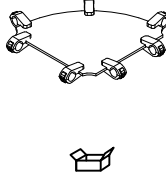
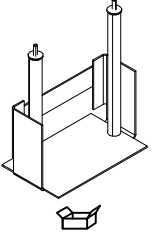

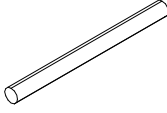
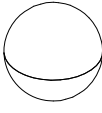
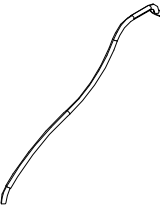
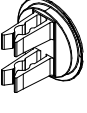
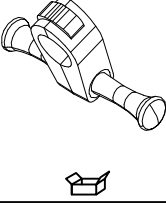
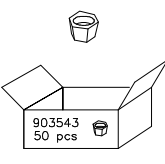
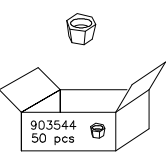
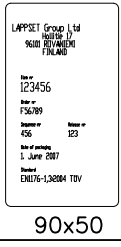
 701967	PCS 1	 701985	PCS 4	 701986	PCS 1	 701987	PCS 1	 701989	PCS 1	 702285	PCS 1
 901941	PCS 7	 901991 L 1493	PCS 1	 902022 L 710	PCS 3	 902134	PCS 9	 902141	PCS 2	 904747 60x60x2	PCS 26
 902253	PCS 2	 903699 903543 50 pcs	PCS 2	 903700 903544 50 pcs	PCS 2	 702341 LAPPSET Group Ltd 90101 601010101 Date of approval: 12/24/56 Issue: F56/089 Approved by: K25 Date of printing: 1. June 2007 Standard: EN50176-1:2004 TDV 90x50	PCS 1		PCS		PCS
	PCS		PCS		PCS		PCS		PCS		PCS
	PCS		PCS		PCS		PCS		PCS		PCS
	PCS		PCS		PCS		PCS		PCS		PCS
	PCS		PCS		PCS		PCS		PCS		PCS

EN/ÅS Impact Area 21.7 m<sup>2</sup>  
Grid size = 500 mm.

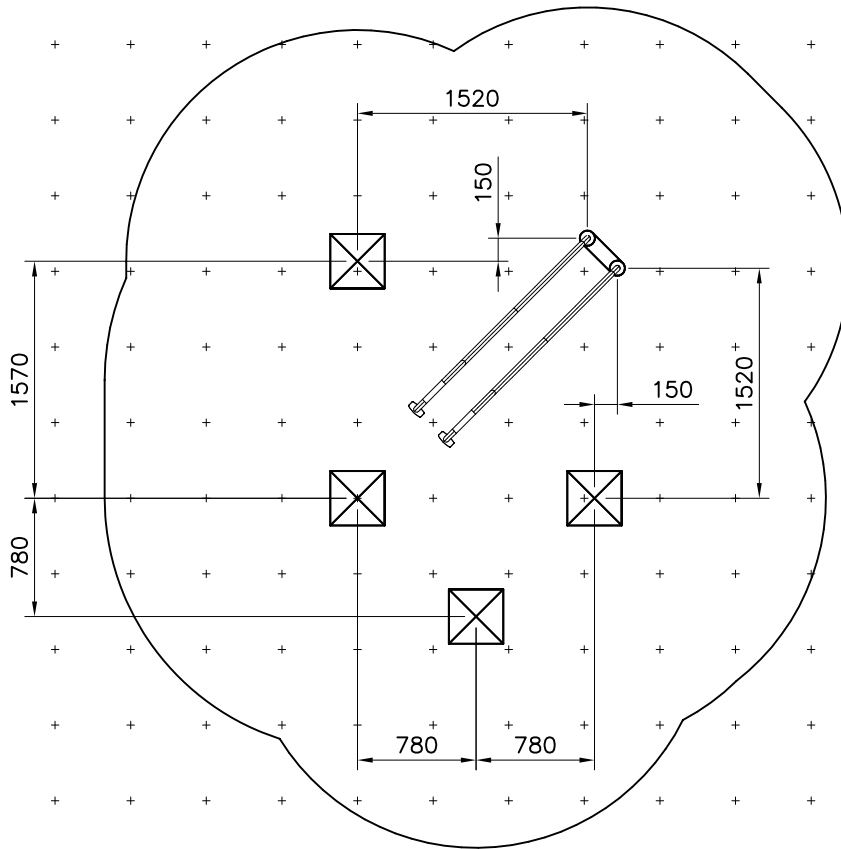
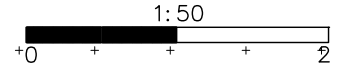

EN/AS Impact Area 21.7 m<sup>2</sup>  
 Falling Space 21.7 m<sup>2</sup>  
 Max Falling Height 1740 mm

