

LAPPSET®





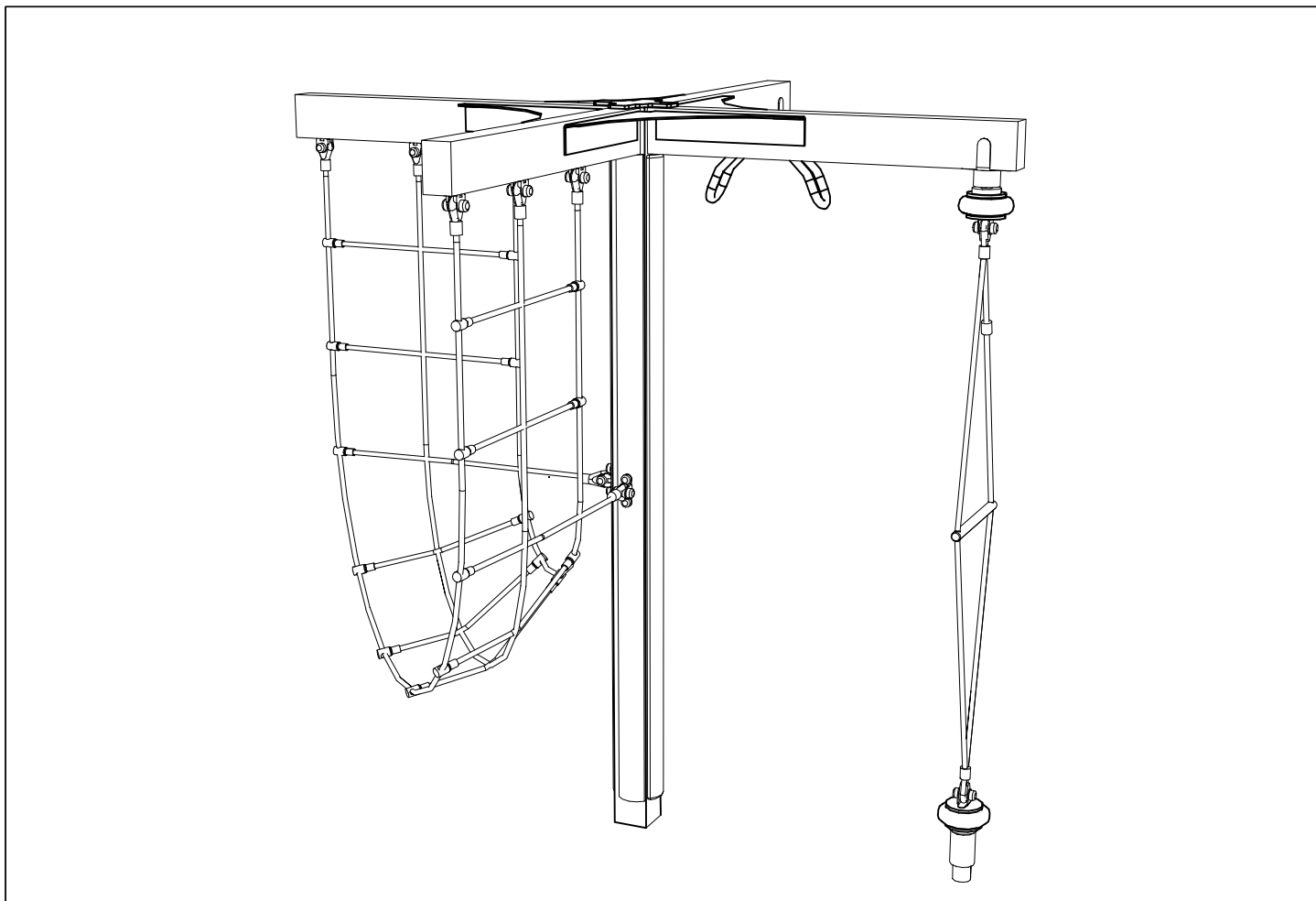

CLUB

ASENNUSOHJE
MONTERINGSANSVISNING
INSTALLATION INSTRUCTION
AUFBAUANLEITUNG
NOTICE D'INSTALLATION

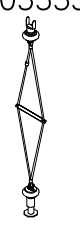
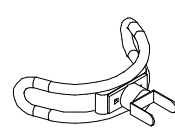
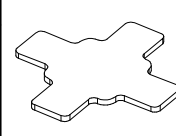
REF: 150105
DATE: 8.2.2005

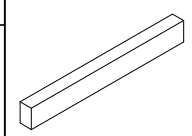
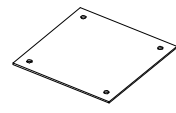
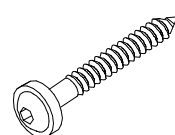
150105

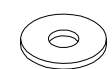
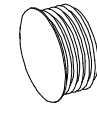
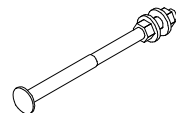
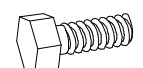

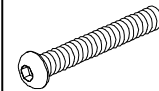
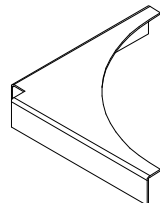
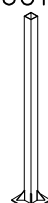
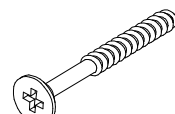
005355 	PCS 1	005358 	PCS 1	005365 	PCS 1	006860  L 2200	PCS 2	006869 	PCS 1	006892  L 1200	PCS 4
009917  350x350	PCS 1	900240  8x70	PCS 72	903112  L 750	PCS 1	905013  5mm	PCS 1	905051  Ø24/8.5	PCS 16	905103  PT-28/32-H	PCS 16
909215  HPM 16x280	PCS 4	909629  10x30	PCS 8	909637  M10	PCS 8	909638  Ø20/10.5	PCS 16	909851  8x55 RST	PCS 16	929460 	PCS 4
960120  L 2900	PCS 1	980107  6x60	PCS 4		PCS		PCS		PCS		PCS
	PCS		PCS		PCS		PCS		PCS		PCS
	PCS		PCS		PCS		PCS		PCS		PCS
	PCS		PCS		PCS		PCS		PCS		PCS

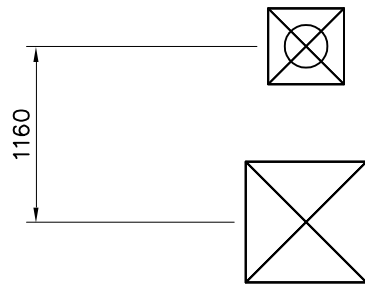
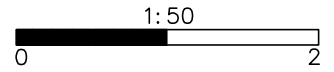

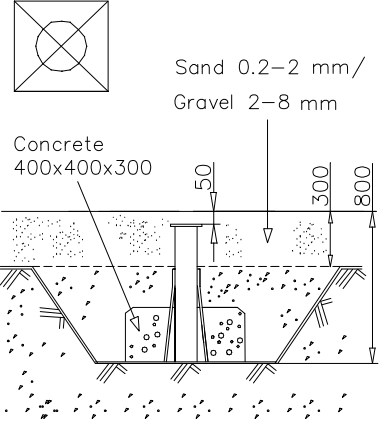
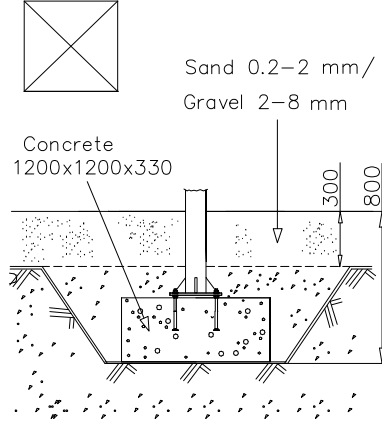
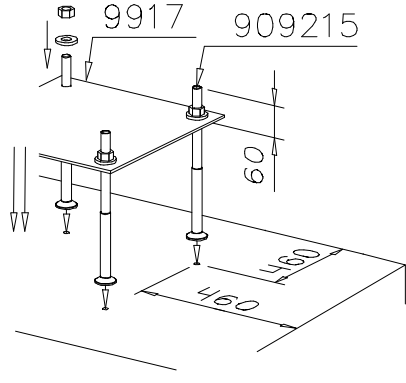
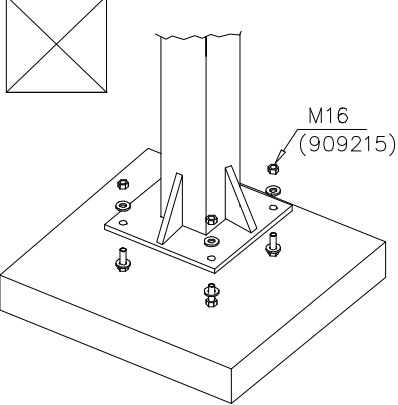
 <p>Sand 0.2–2 mm/ Gravel 2–8 mm</p> <p>Concrete 400x400x300</p> <p>50 300 800</p>	 <p>Sand 0.2–2 mm/ Gravel 2–8 mm</p> <p>Concrete 1200x1200x330</p> <p>300 800</p>	 <p>9917 909215</p> <p>60</p> <p>450</p>
 <p>M16 (909215)</p>		

EN Impact Area 32.7 m2

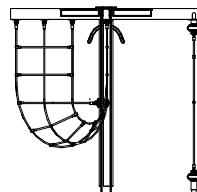
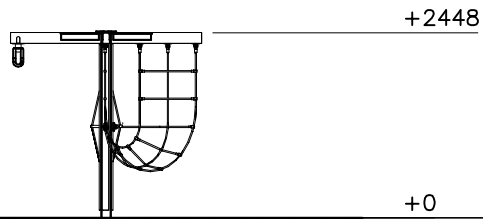
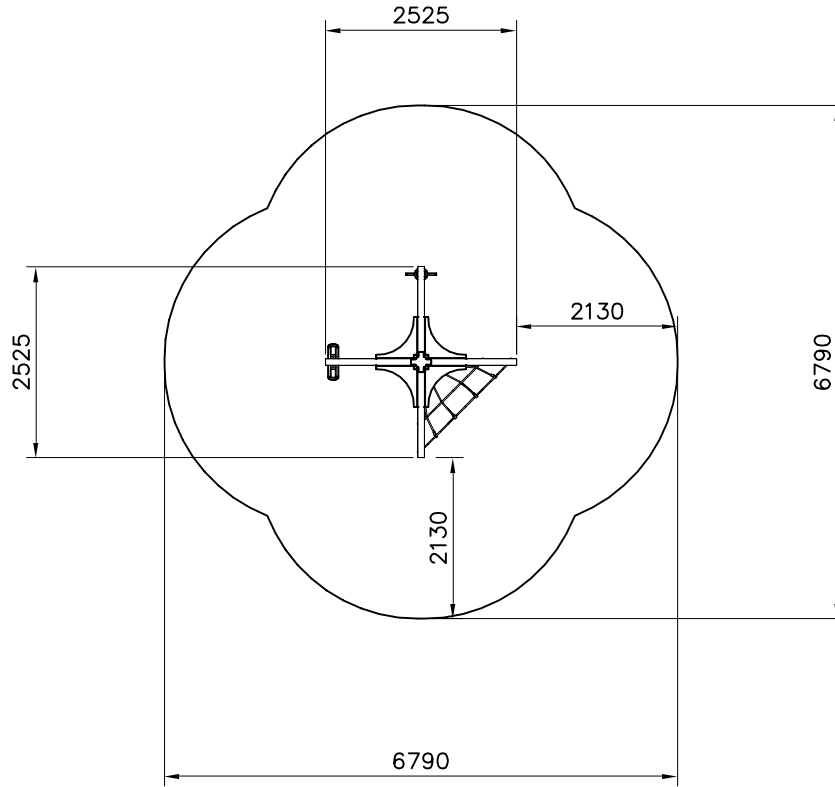
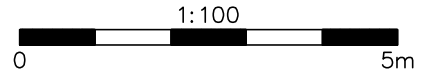

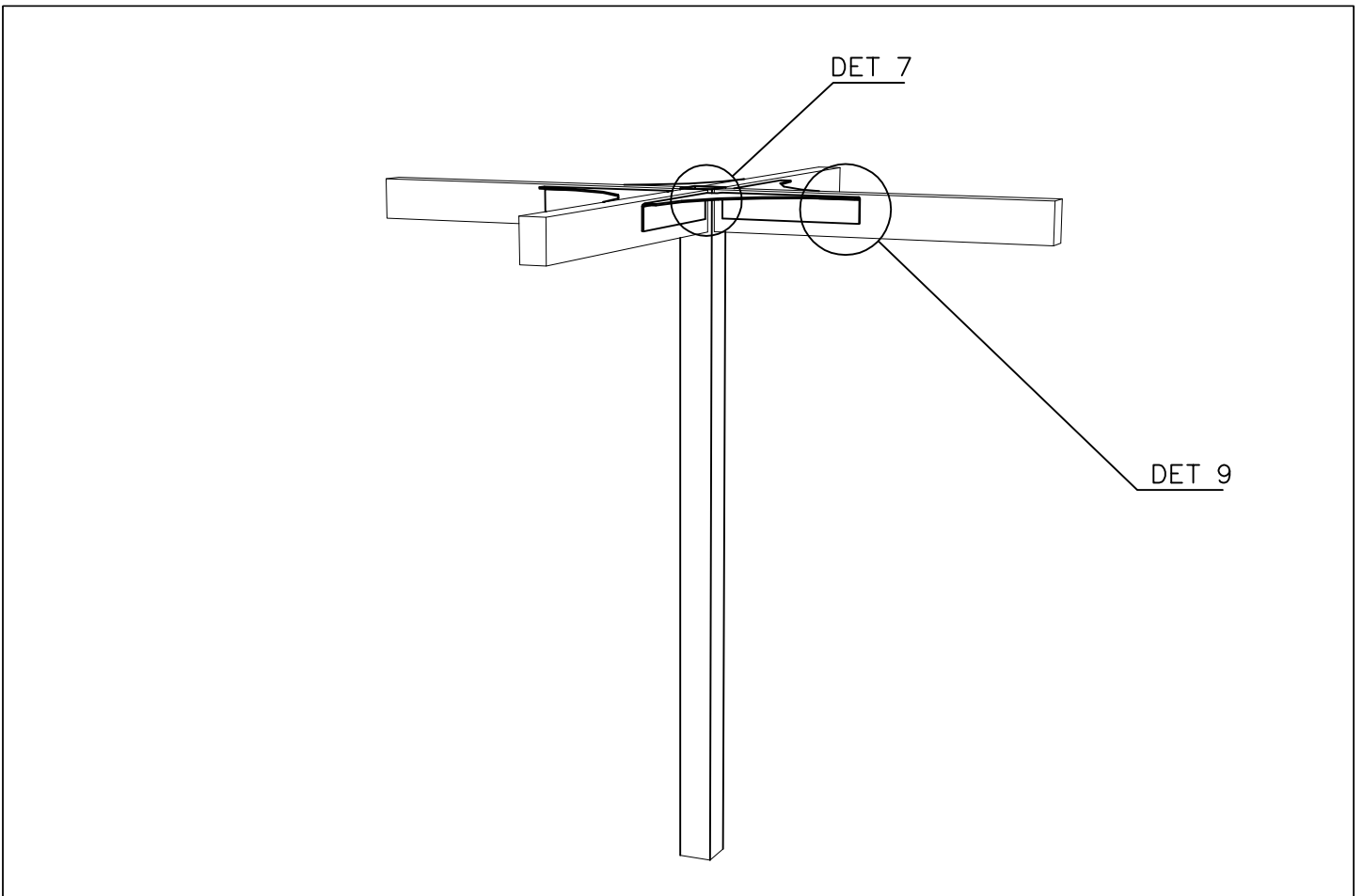
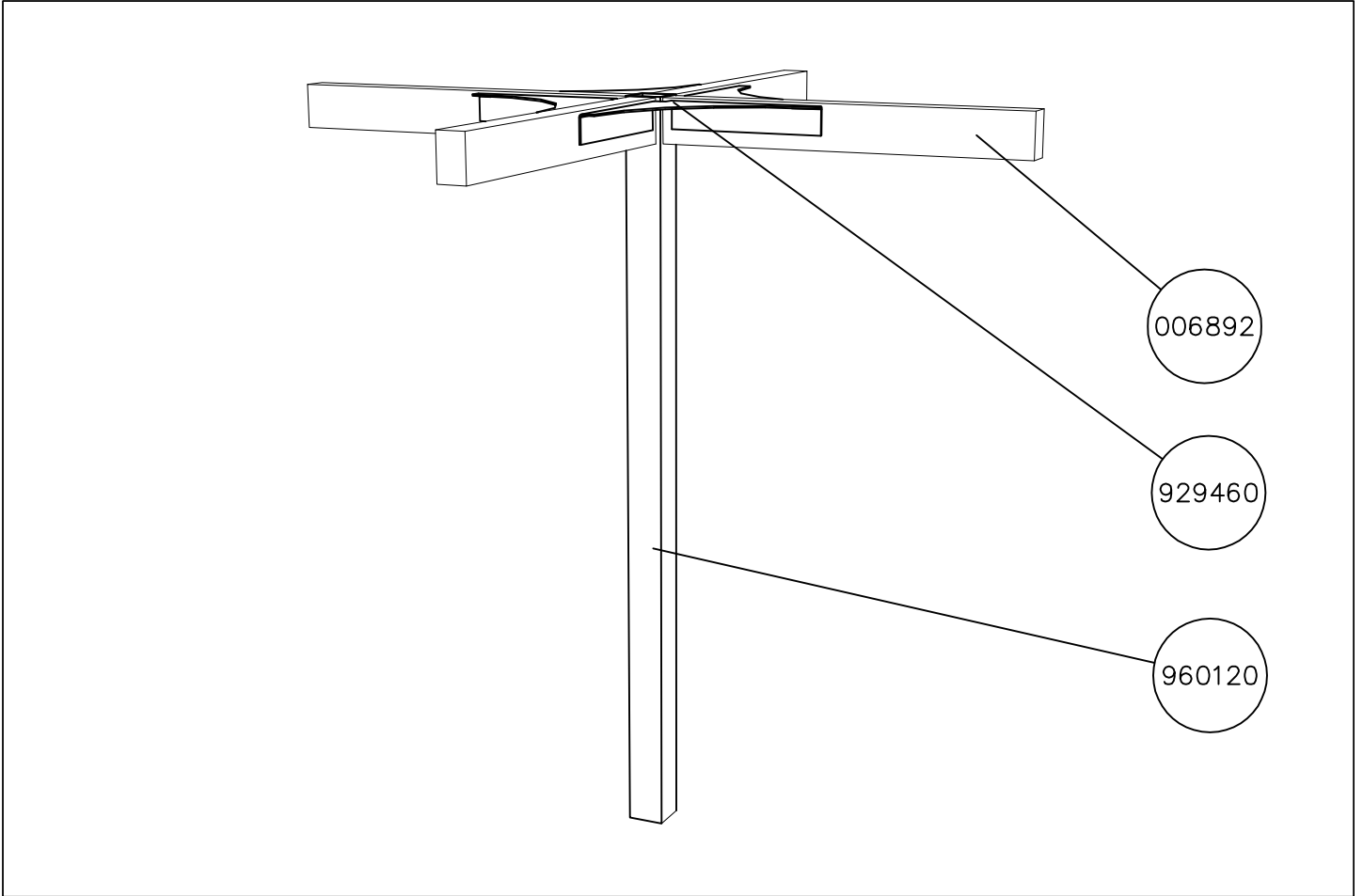

<p>DET 1</p>	<p>DET 2</p>	<p>DET 3</p>	<p>DET 4</p>
<p>DET 5</p>	<p>DET 6</p>	<p>DET 7</p>	<p>DET 8</p>
<p>DET 9</p>			

