

LAPPSET®

FINNO

ASENNUSOHJE
MONTERINGSANSVISNING
INSTALLATION INSTRUCTION
AUFBAUANLEITUNG
NOTICE D'INSTALLATION

REF: 122354
DATE: 1.4.2005

122354



| | | | | | | | | | | | |
|--------|----------|---------|-----------|--------|-----------|--------|-----------|--------|-----------|--------|----------|
| 001770 | PCS 1 | 001848 | PCS 1 | 002781 | PCS 1 | 003011 | PCS 1 | 003618 | PCS 1 | 003775 | PCS 1 |
| | | | | | | | | | | | |
| 003780 | PCS 2 | 003787 | PCS 1 | 003798 | PCS 1 | 003886 | PCS 4 | 005077 | PCS 1 | 005271 | PCS 1 |
| | | | | | | | | | | | |
| 005610 | PCS 4 | 005692 | PCS 4 | 006810 | PCS 2 | 006816 | PCS 4 | 006822 | PCS 4 | 007875 | PCS 1 |
| | | | | | | | | | | | |
| | | L 1104 | | L 1050 | | L 1650 | | L 2250 | | | |
| 900240 | PCS 6 | 905051 | PCS 16 | 905104 | PCS 40 | 905120 | PCS 20 | 905138 | PCS 6 | 905196 | PCS 6 |
| | | | | | | | | | | | |
| 8x70 | | Ø24/8.4 | | M10 | | Ø14 | | GREY | | GREY | |
| 907045 | PCS 1 | 909238 | PCS 16 | 909521 | PCS 10 | 909540 | PCS 2 | 980131 | PCS 24 | | PCS |
| | | | | | | | | | | | |
| L 1490 | | 8x90 | | | | | | 6x60 | | | |
| | PCS | | PCS | | PCS | | PCS | | PCS | | PCS |
| | | | | | | | | | | | |
| | PCS | | PCS | | PCS | | PCS | | PCS | | PCS |
| | | | | | | | | | | | |

| | | |
|---|---|---|
| <p>M10 905104 909521</p> | <p>Sand 0.2-2 mm/ Gravel 2-8 mm</p> <p>100 300 600</p> | <p>Sand 0.2-2 mm/ Gravel 2-8 mm</p> <p>300 400</p> |
| <p>907040 Sand 0.2-2 mm/ Gravel 2-8 mm</p> <p>300 600</p> | <p>Sand 0.2-2 mm/ Gravel 2-8 mm</p> <p>300 600</p> | <p>909519 Ø24/8.4 M8</p> |
| | | |
| | | |

EN Impact Area 37.7 m²

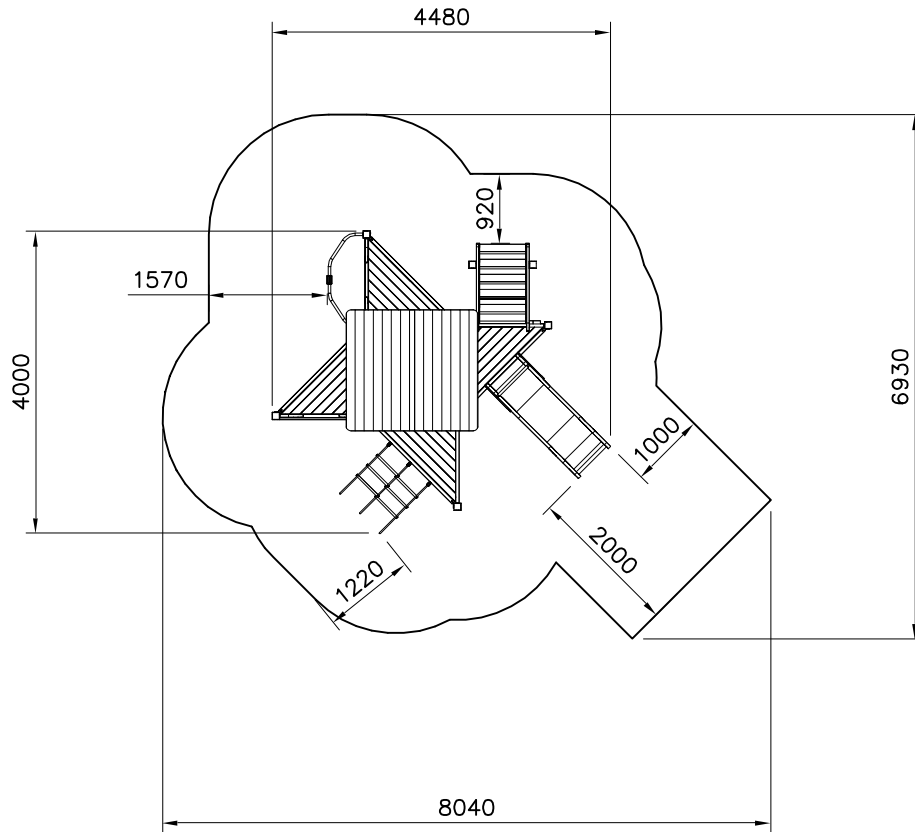
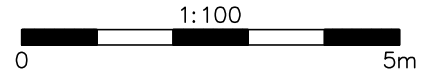

+2700

+870

+0

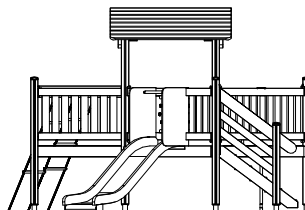
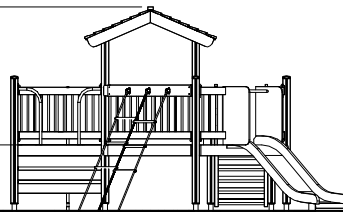

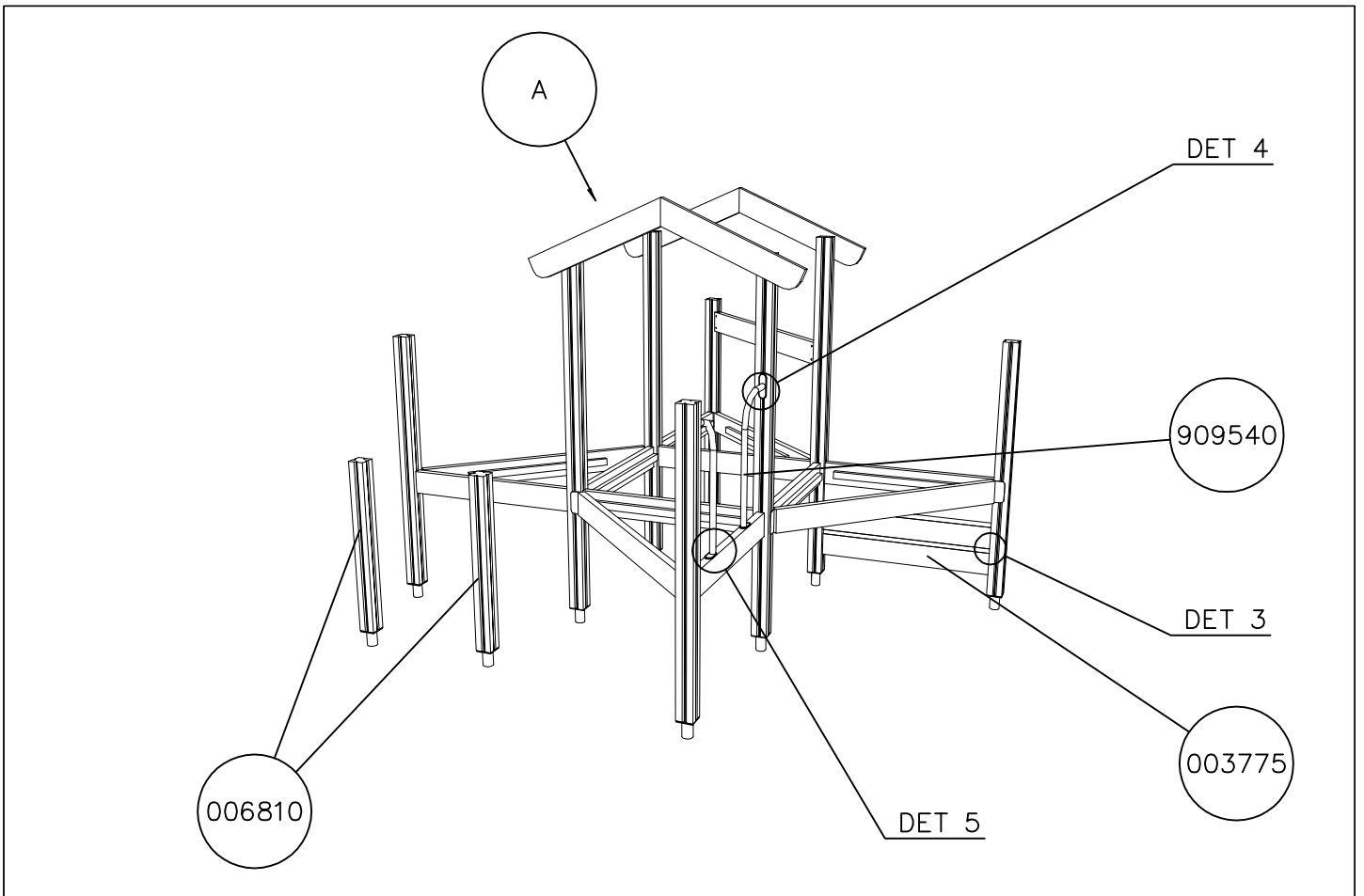
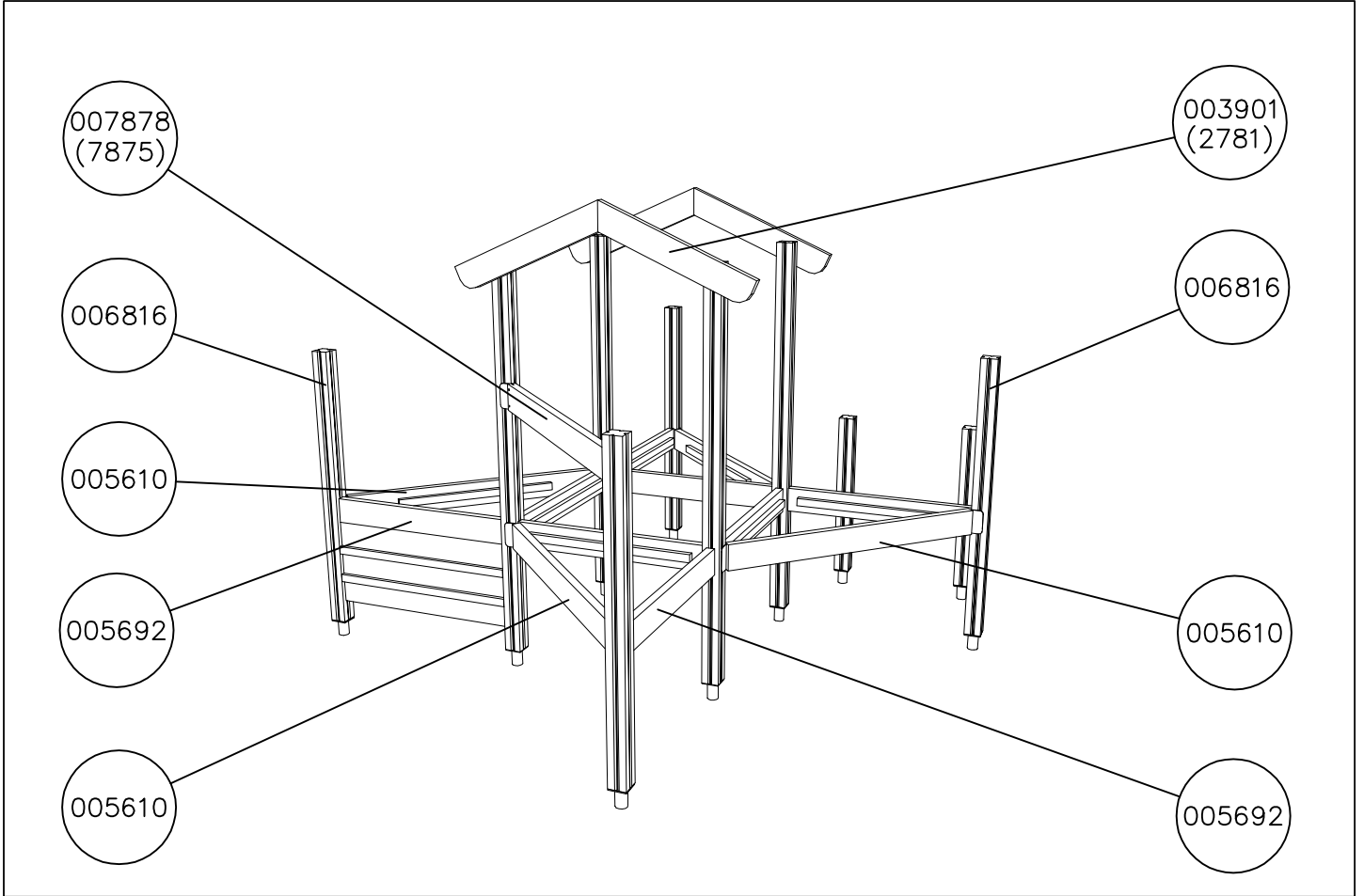

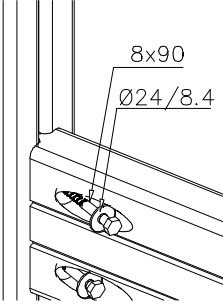
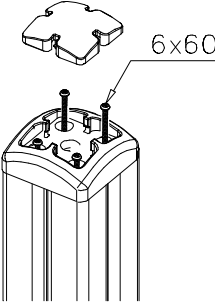
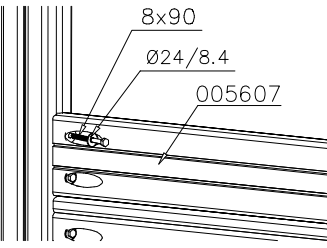
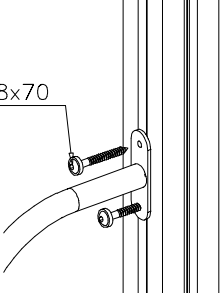
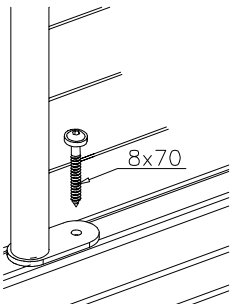
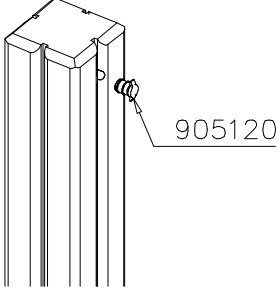
| | | | |
|--|--|--|--|
| <p>DET 1</p>  <p>8x90 Ø24/8.4</p> | <p>DET 2</p>  <p>6x60</p> | <p>DET 3</p>  <p>8x90 Ø24/8.4 005607</p> | <p>DET 4</p>  <p>8x70</p> |
| <p>DET 5</p>  <p>8x70</p> | <p>DET 6</p>  <p>905120</p> | | |
| | | | |
| | | | |
| | | | |

