

LAPPSET®

FINNO







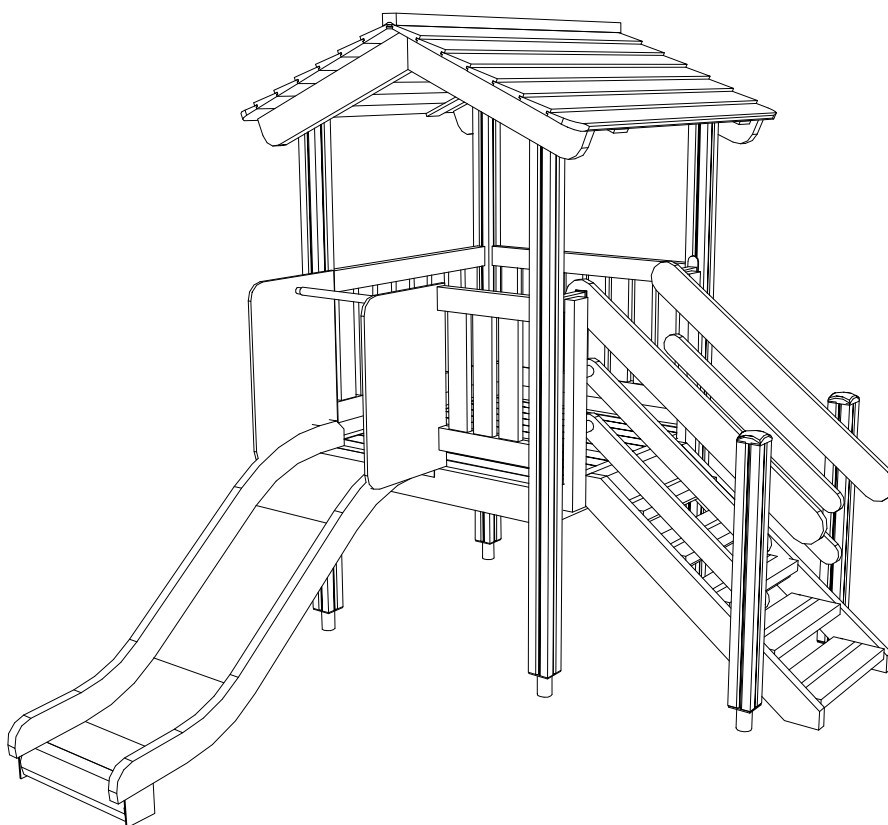

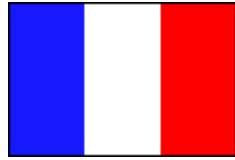
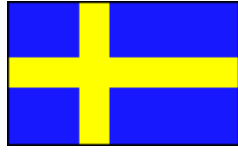

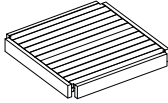
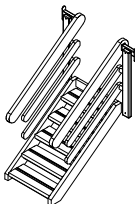
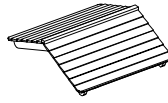
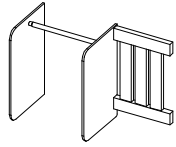
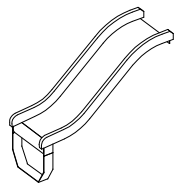
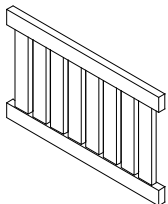

ASENNUSOHJE
MONTERINGSANSVISNING
INSTALLATION INSTRUCTION
AUFBAUANLEITUNG
NOTICE D'INSTALLATION

REF: 122347
DATE: 15.6.2003

122347



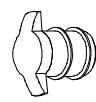
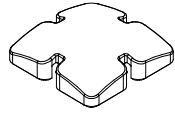
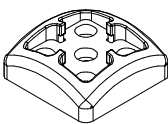
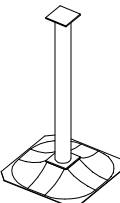

001770	PCS 1	001848	PCS 1	002781	PCS 1	003010	PCS 1	003618	PCS 1	003787	PCS 2
											
										 BLUE	
006810	PCS 2	006822	PCS 4	905104	PCS 24	905120	PCS 12	905138	PCS 2	905196	PCS 2
											
L 1050		L 2250		M10		Ø14		GREY		GREY	
909521	PCS 6	980131	PCS 8		PCS		PCS		PCS		PCS
											
		6x60									
	PCS		PCS		PCS		PCS		PCS		PCS
	PCS		PCS		PCS		PCS		PCS		PCS
	PCS		PCS		PCS		PCS		PCS		PCS
	PCS		PCS		PCS		PCS		PCS		PCS

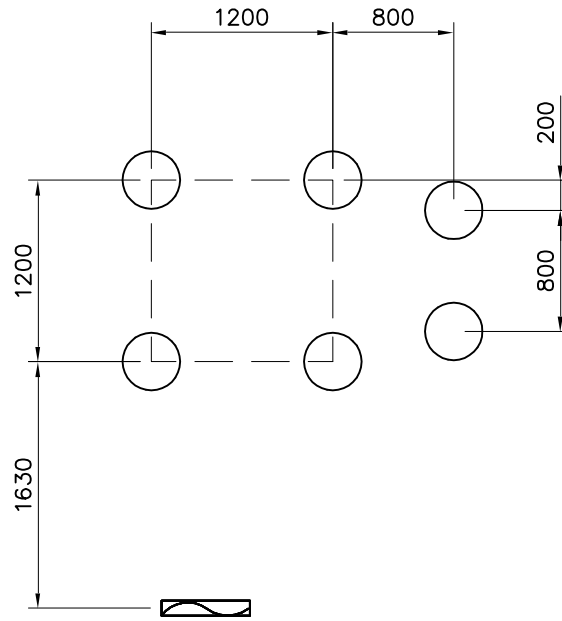
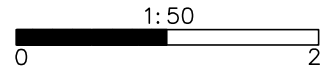

<p>M10 905104 909521</p>	<p>Sand 0.2-2 mm/ Gravel 2-8 mm 100 300 600</p>	<p>Sand 0.2-2 mm/ Gravel 2-8 mm 300 400</p>	

EN Impact Area 23.4 m²

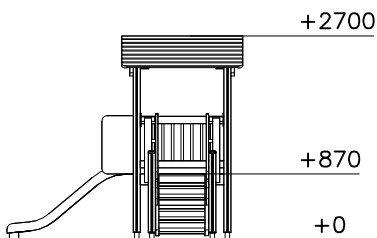
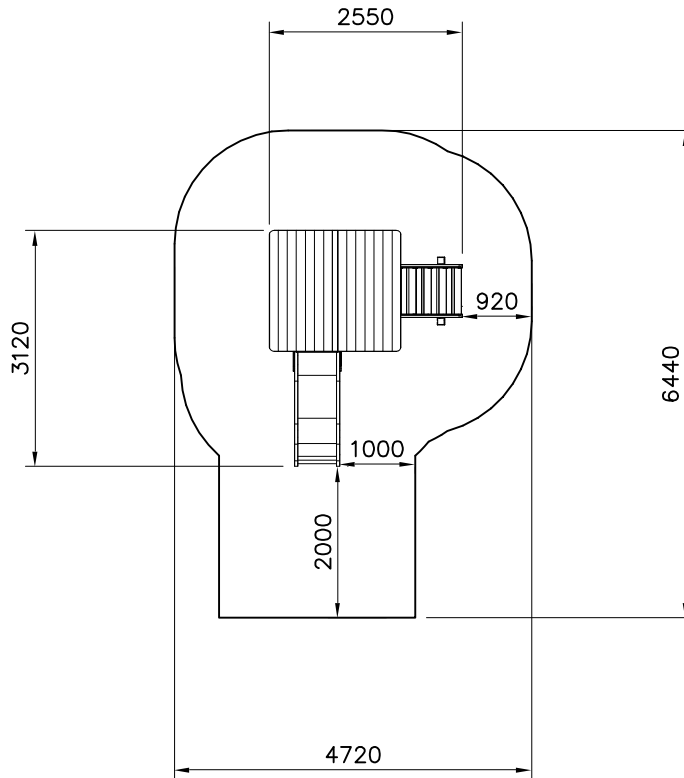
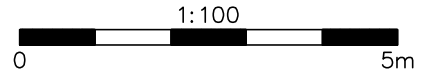

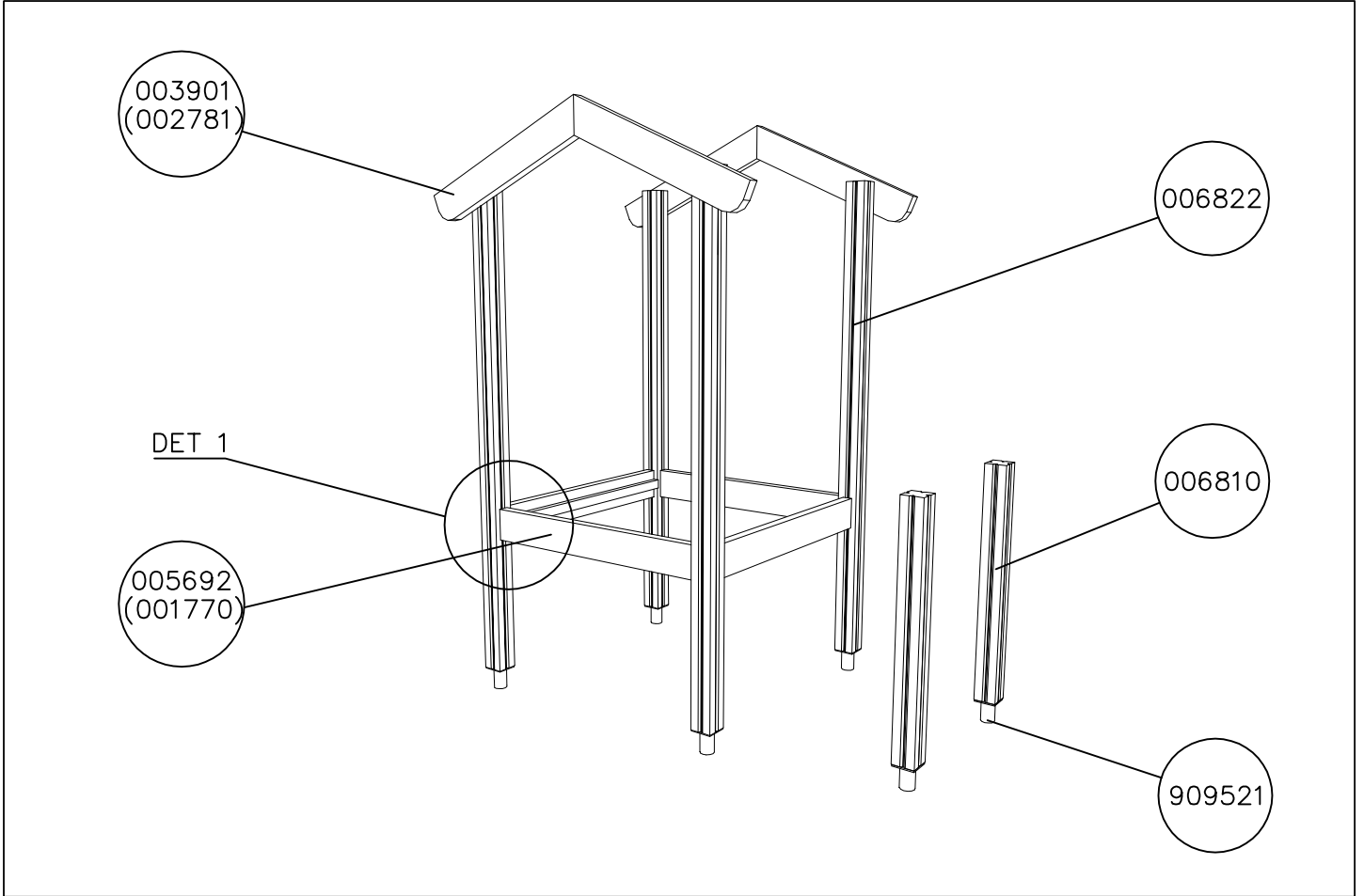

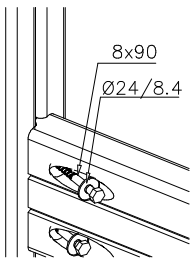
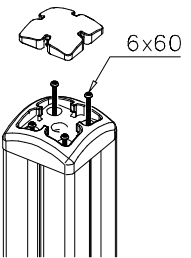
DET 1 	DET 2 	DET 3 