

LAPPSET®

FINNO







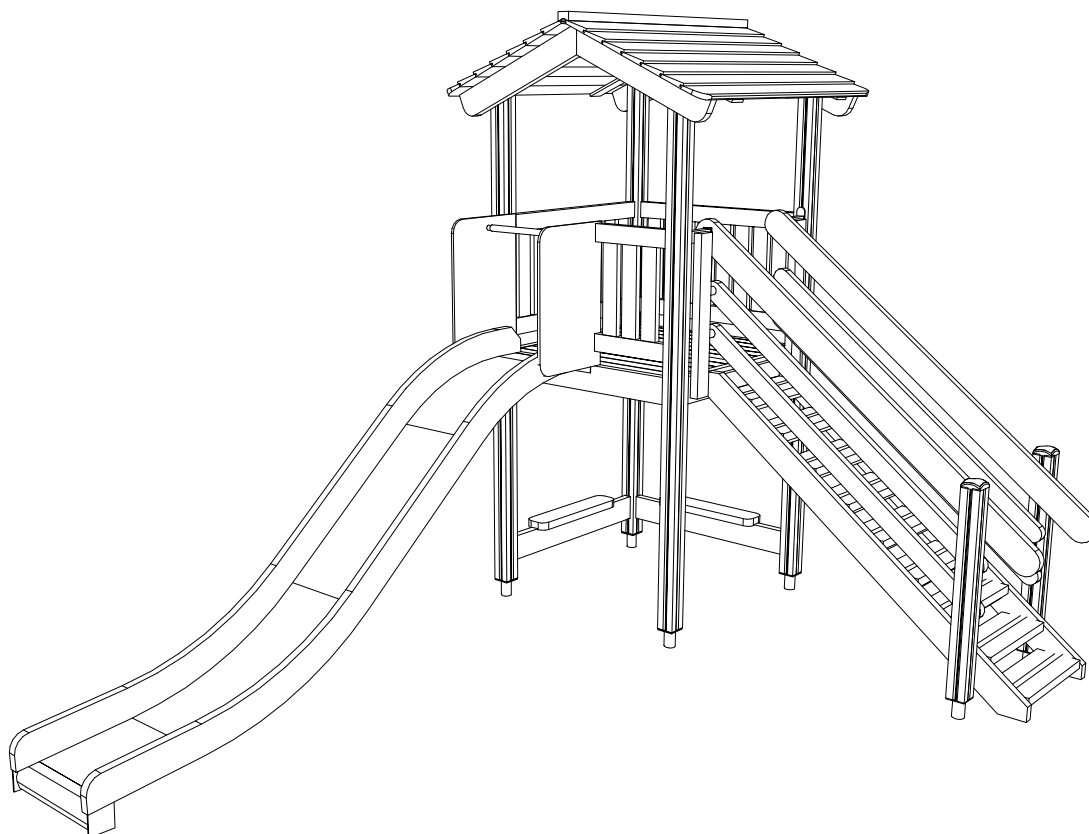

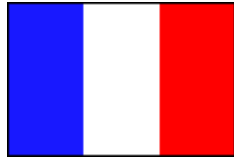
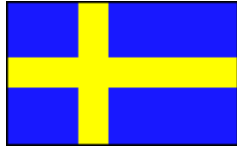

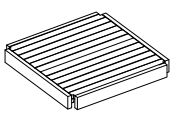
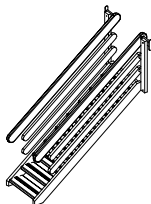
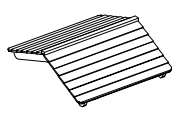
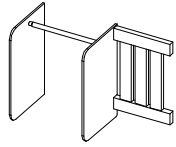
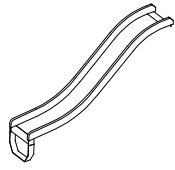
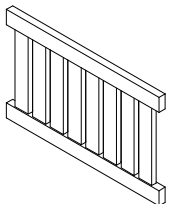

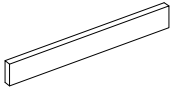
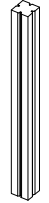

ASENNUSOHJE
MONTERINGSANSVISNING
INSTALLATION INSTRUCTION
AUFBAUANLEITUNG
NOTICE D'INSTALLATION

REF: 122345
DATE: 15.6.2003

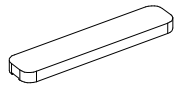
122345



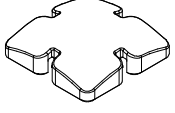
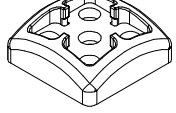
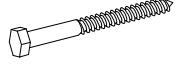
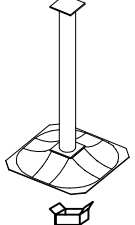

001770	PCS 1	001849	PCS 1	002781	PCS 1	003010	PCS 1	003614	PCS 1	003788	PCS 2
											
										 YELLOW	
005692	PCS 2	006810	PCS 2	006828	PCS 4	007333	PCS 2	905051	PCS 8	905104	PCS 24
											
L 1104		L 1050		L 2850				Ø24/8.4		M10	
905120	PCS 12	905138	PCS 2	905196	PCS 2	909238	PCS 8	909521	PCS 6	980131	PCS 8
											
Ø14		GREY		GREY		8x90				6x60	
	PCS		PCS		PCS		PCS		PCS		PCS
	PCS		PCS		PCS		PCS		PCS		PCS
	PCS		PCS		PCS		PCS		PCS		PCS
	PCS		PCS		PCS		PCS		PCS		PCS

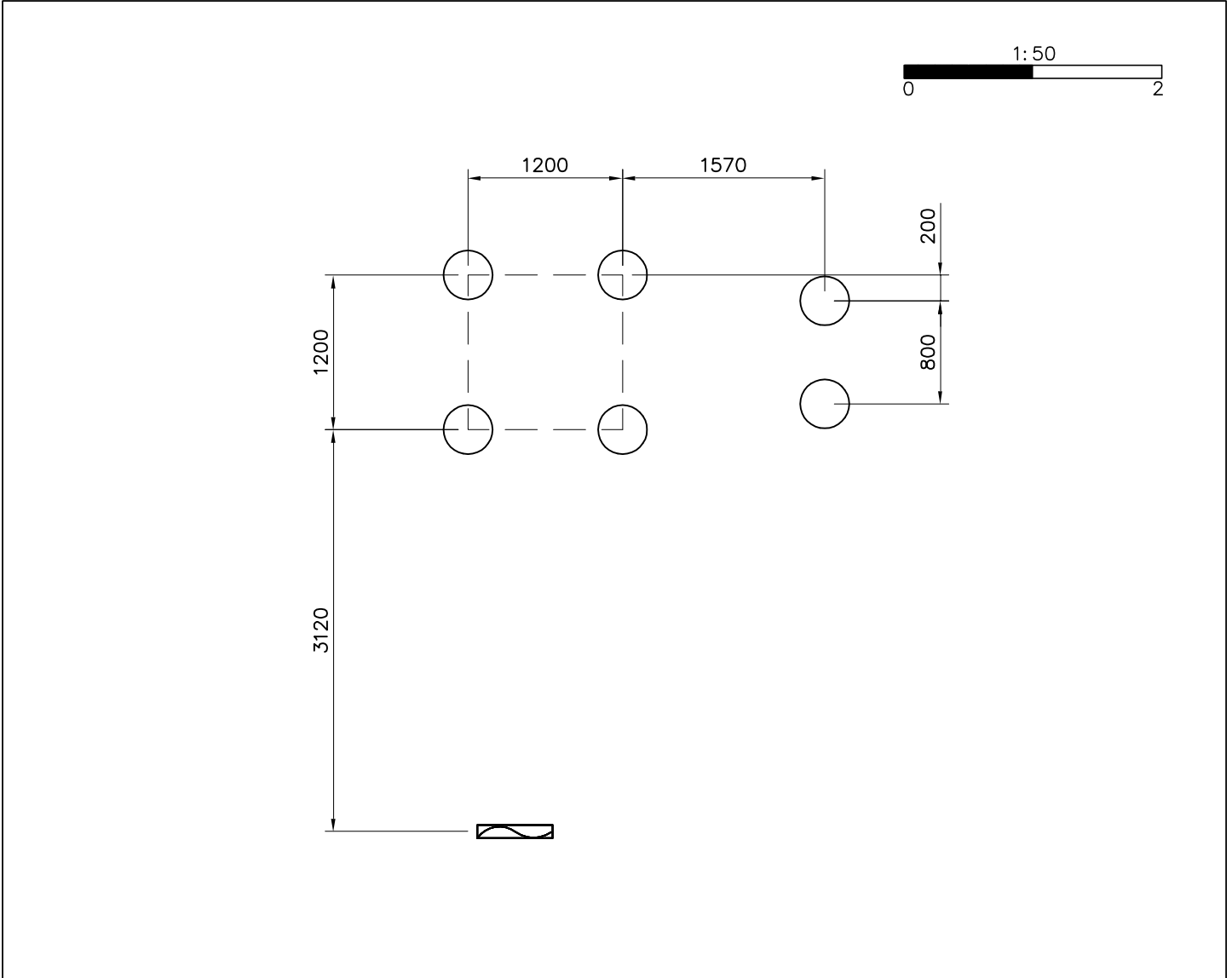

	<p>Sand 0.2-2 mm/ Gravel 2-8 mm</p>	<p>Sand 0.2-2 mm/ Gravel 2-8 mm</p>	

EN Impact Area 31.7 m²

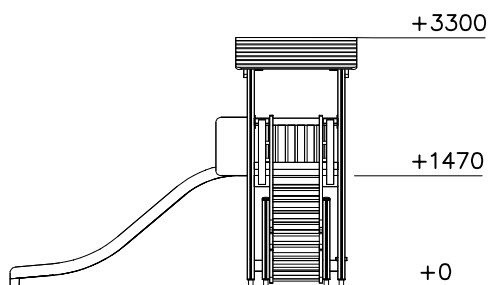
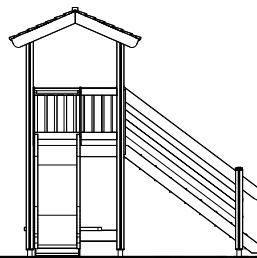
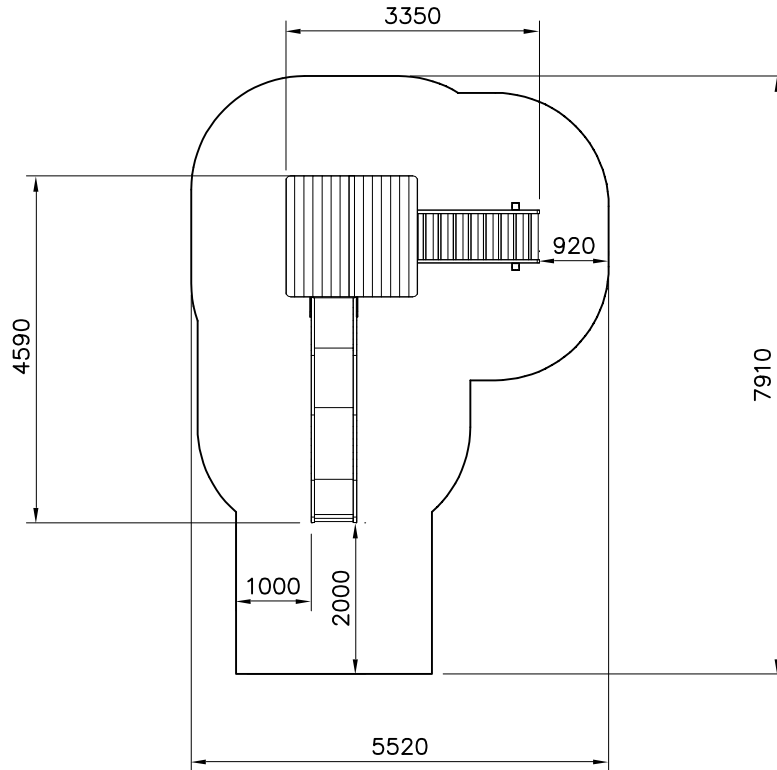
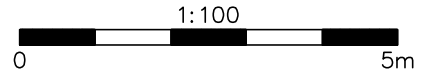

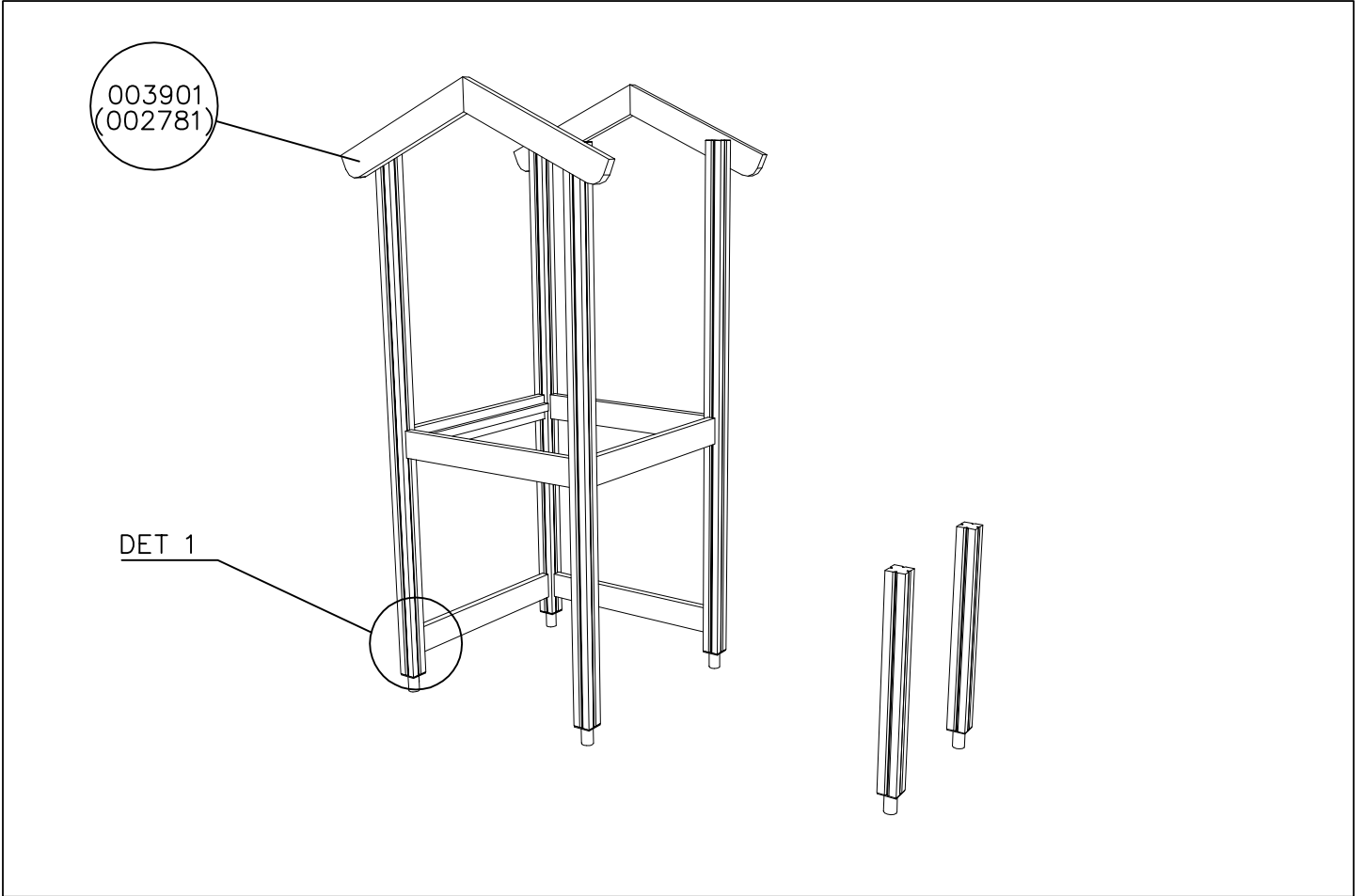

<p>DET 1</p> <p>8x90 Ø24/8.4</p>	<p>DET 2</p> <p>6x60</p>	<p>DET 3</p> <p>905120</p>	

