

LAPPSET®









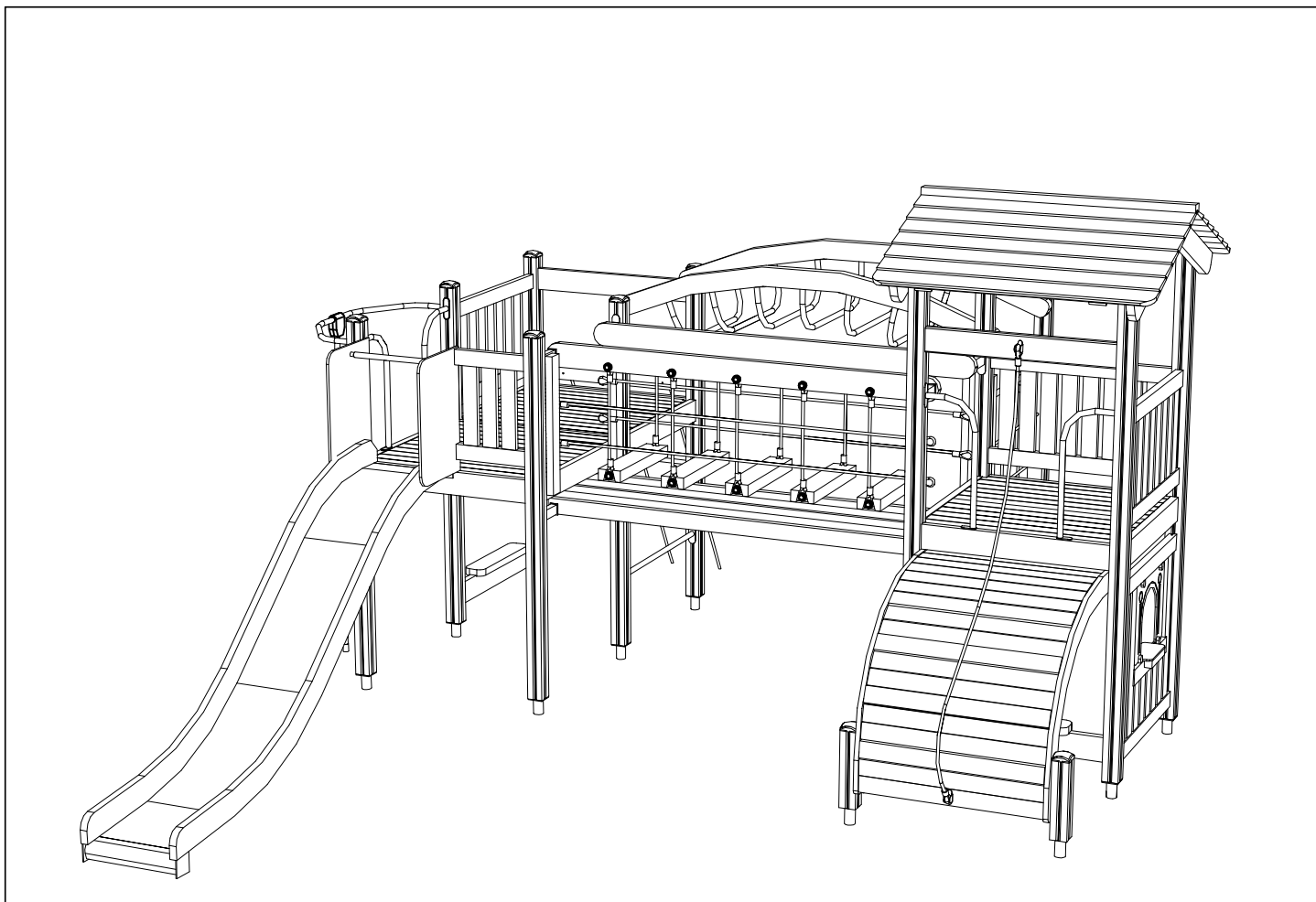

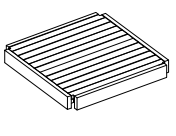

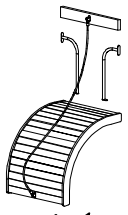

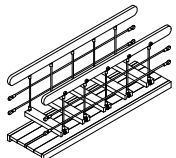

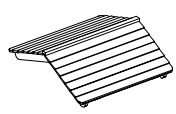

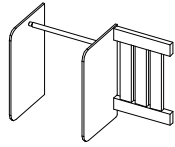

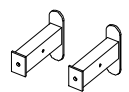

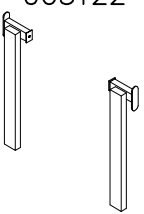

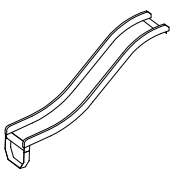

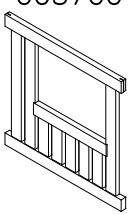

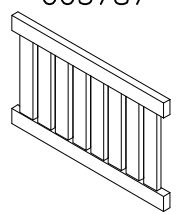

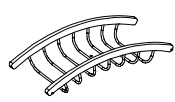

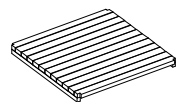

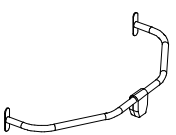

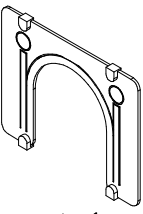

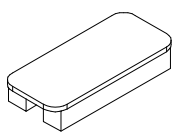

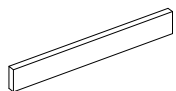
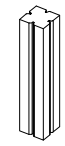

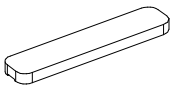

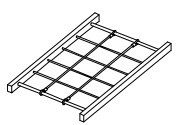

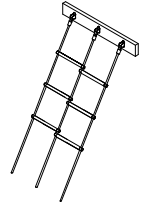
FINNO

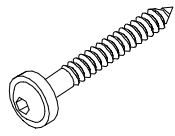
ASENNUSOHJE
MONTERINGSANSVISNING
INSTALLATION INSTRUCTION
AUFBAUANLEITUNG
NOTICE D'INSTALLATION

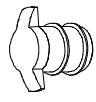
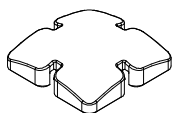
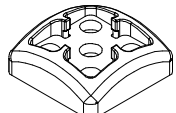
REF: 122100
DATE: 1.4.2005

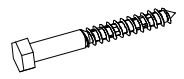
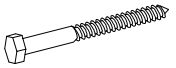
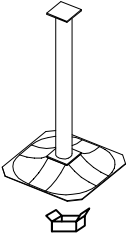
122100

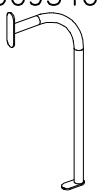
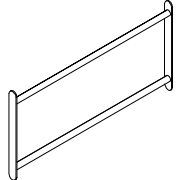

001770  2 	PCS 2	001818  1 	PCS 1	001855  1 	PCS 1	002781  1 	PCS 1	003010  1 	PCS 1	003120  2 	PCS 2
003122  2 	PCS 2	003614  1 	PCS 1	003700  1 	PCS 1	003787  3  BLUE	PCS 3	003838  1 	PCS 1	003880  1 	PCS 1
005077  1 	PCS 1	005273  1 	PCS 1	005285  1 	PCS 1	005692  7 L 1104	PCS 7	006804  2 L 450	PCS 2	006822  7 L 2250	PCS 7
006828  4 L 2850	PCS 4	007333  3 	PCS 3	007841  1 	PCS 1	007874  1 	PCS 1	900240  14 8x70	PCS 14	905051  28 Ø24/8.4	PCS 28
905104  52	PCS 52	905120  30	PCS 30	905138  9 GREY	PCS 9	905196  9 GREY	PCS 9	907044  1 L 2090	PCS 1	909224  4 12x100	PCS 4
909238  28 8x90	PCS 28	909521  13 	PCS 13	909540  2	PCS 2	909569  1 L 1104	PCS 1	980131  36 6x60	PCS 36	980154  4 Ø24/13	PCS 4
	PCS		PCS		PCS		PCS		PCS		PCS

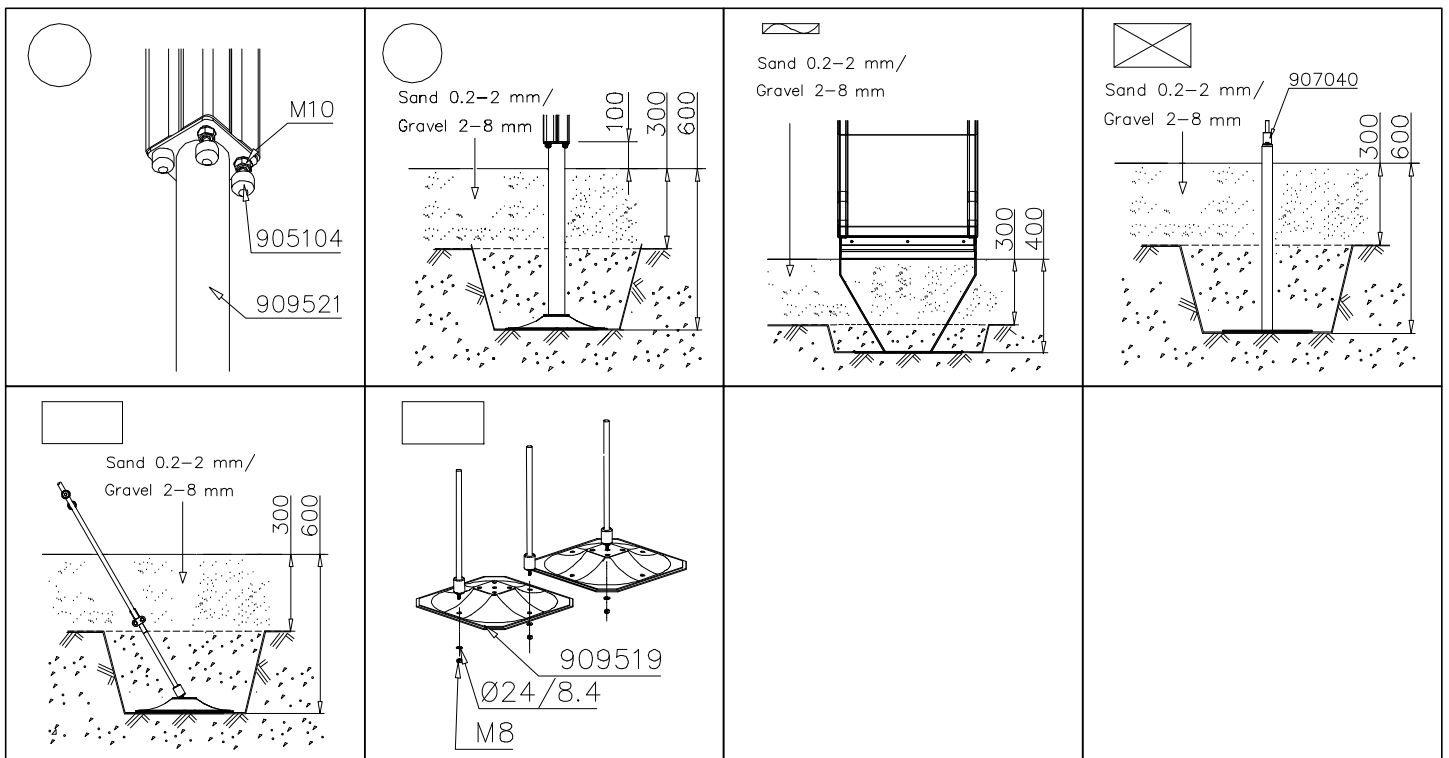
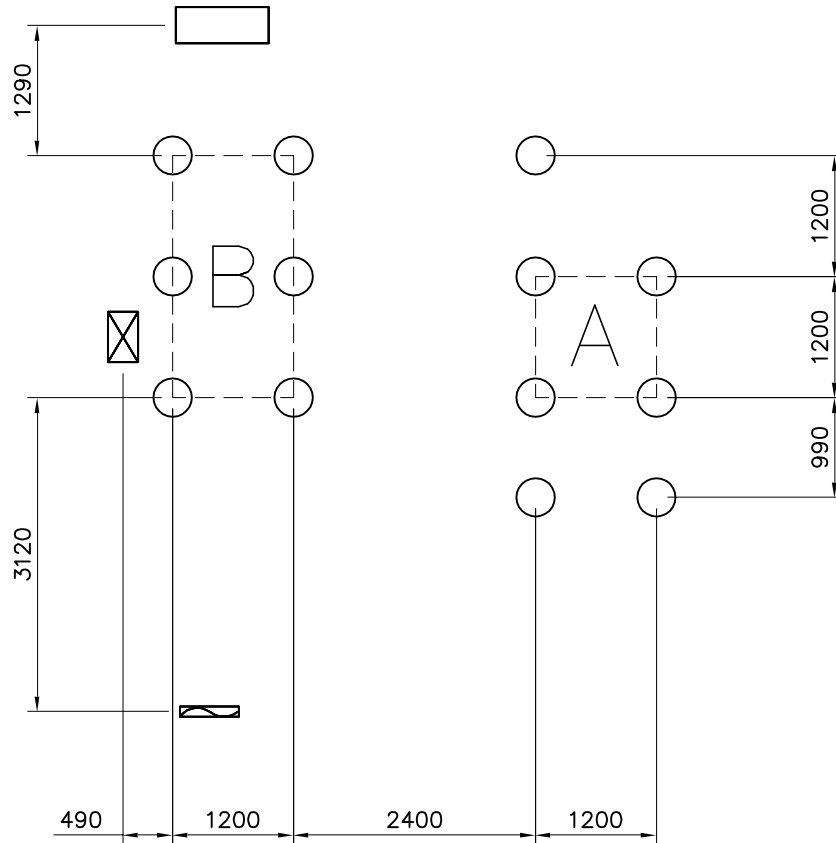
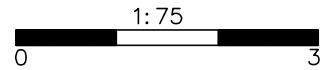

EN Impact Area 61.5 m²

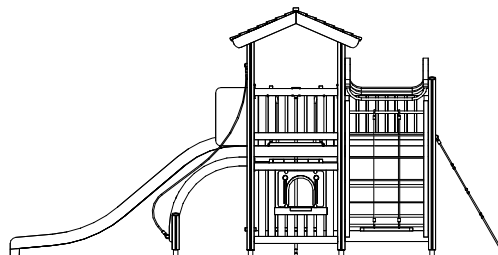
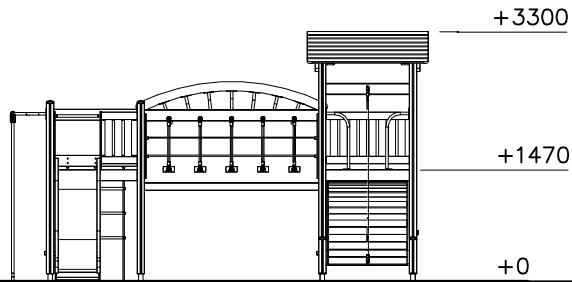
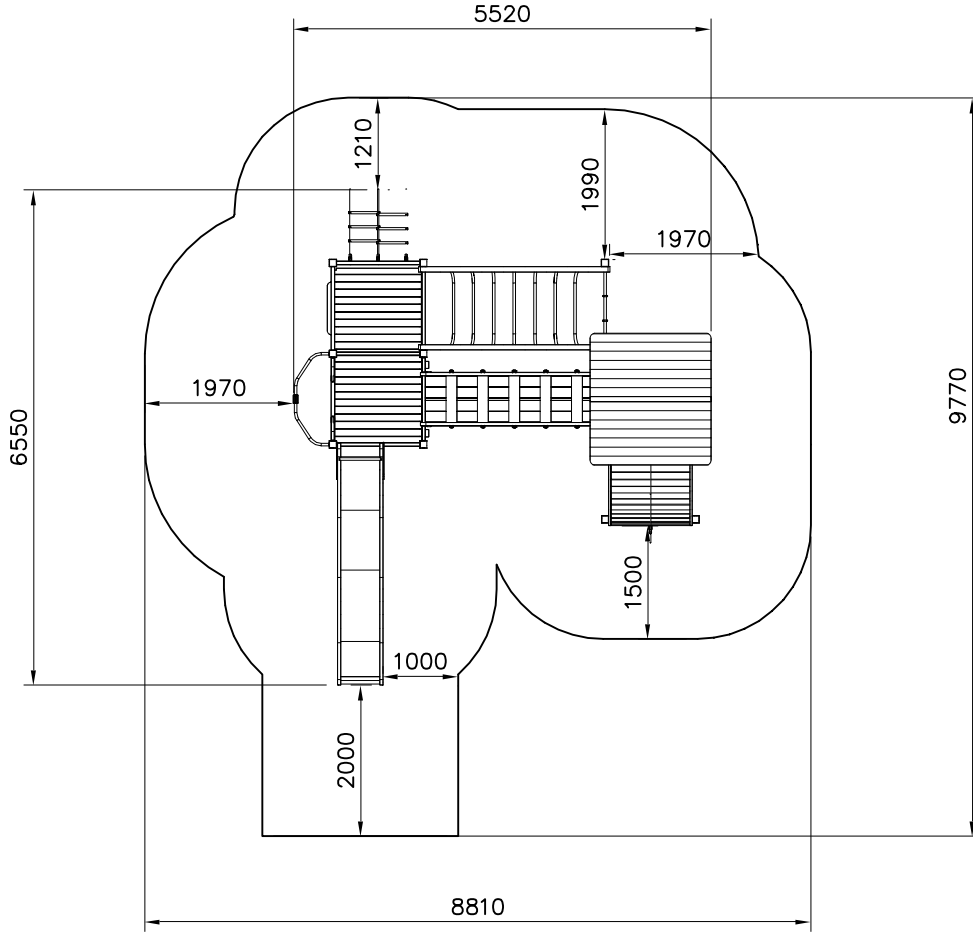
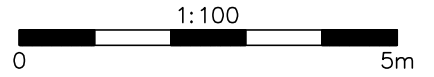

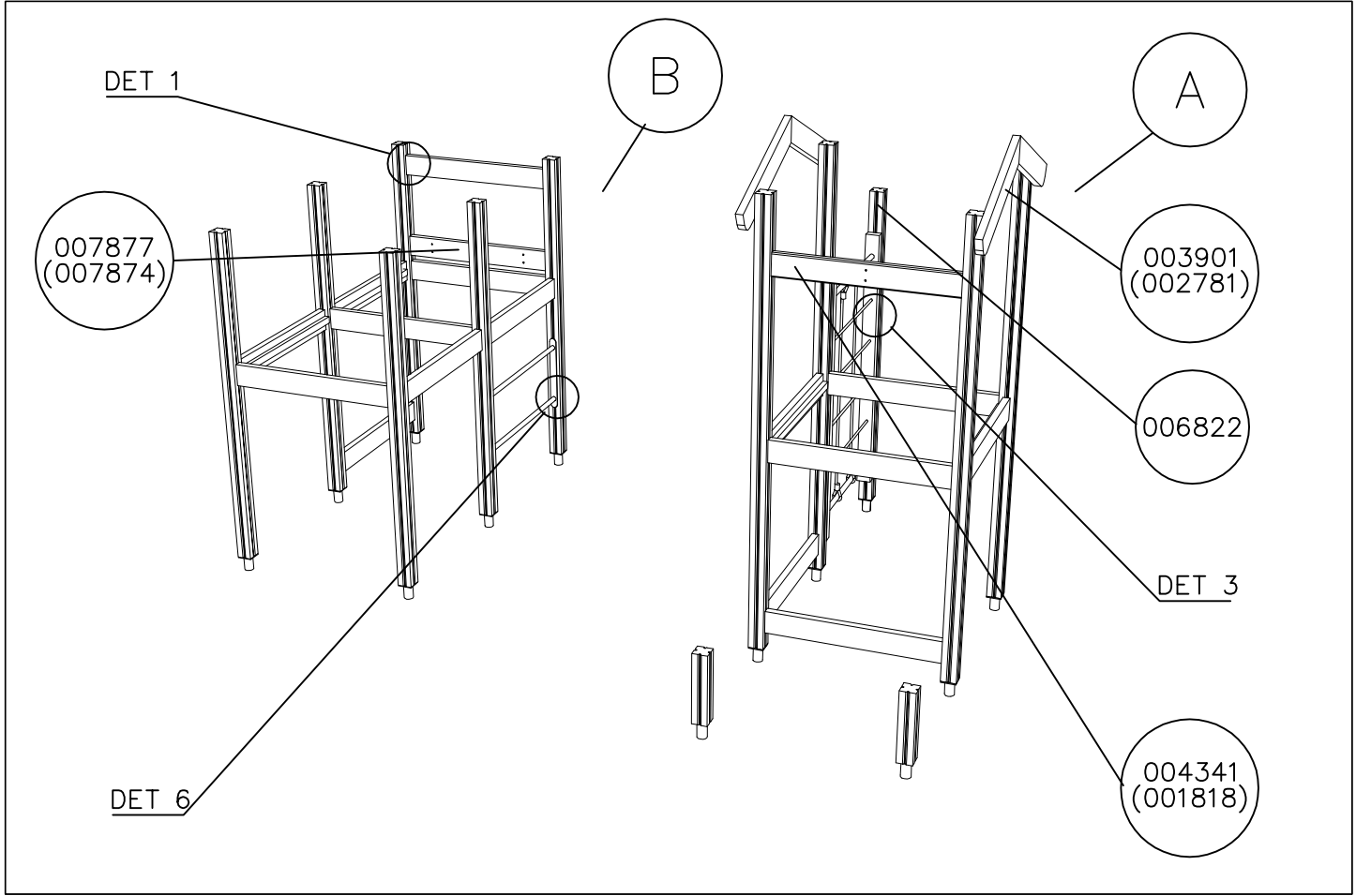

<p>DET 1</p>	<p>DET 2</p>	<p>DET 3</p>	<p>DET 4</p>
<p>DET 5</p>	<p>DET 6</p>	<p>DET 7</p>	

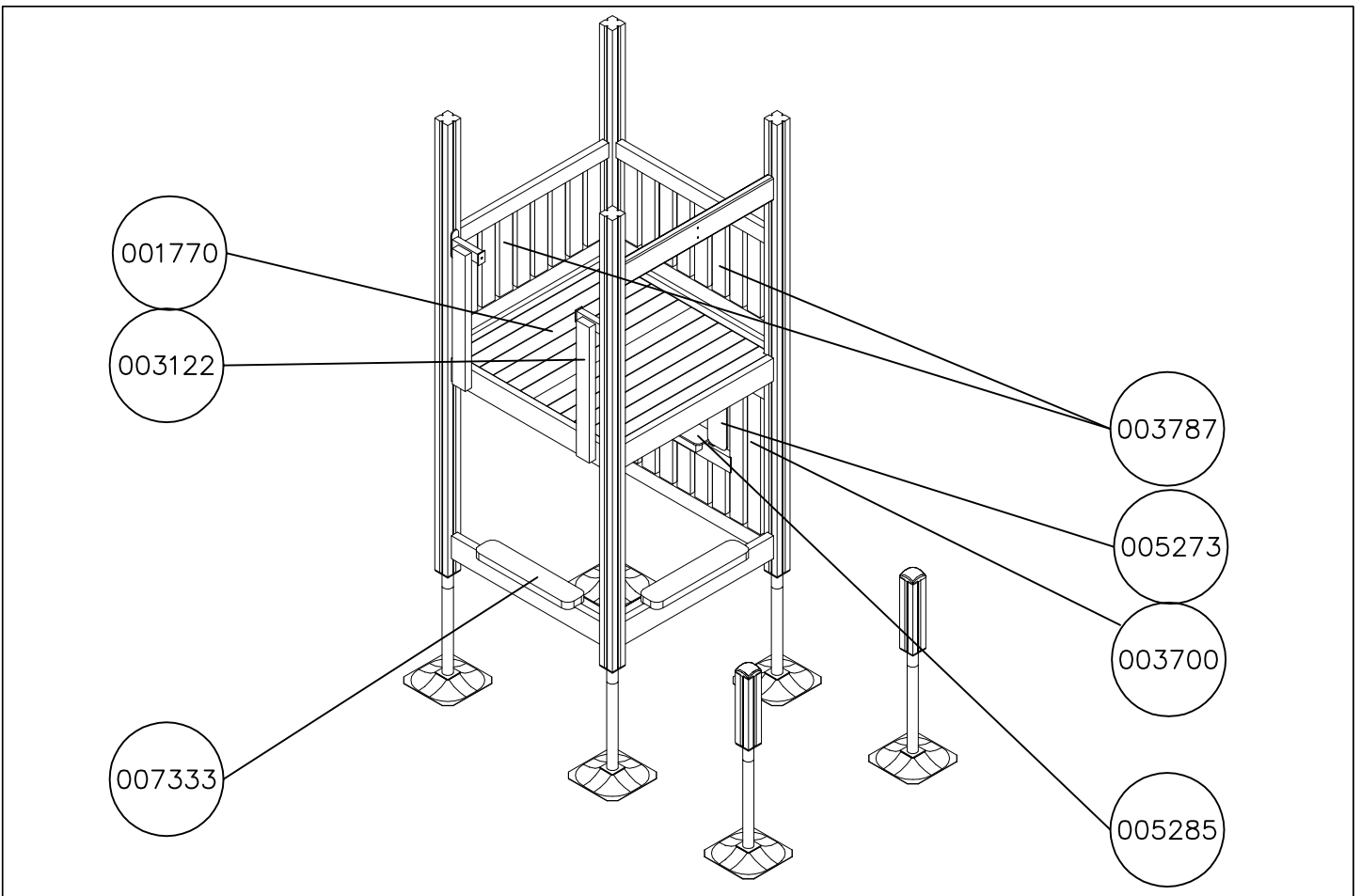
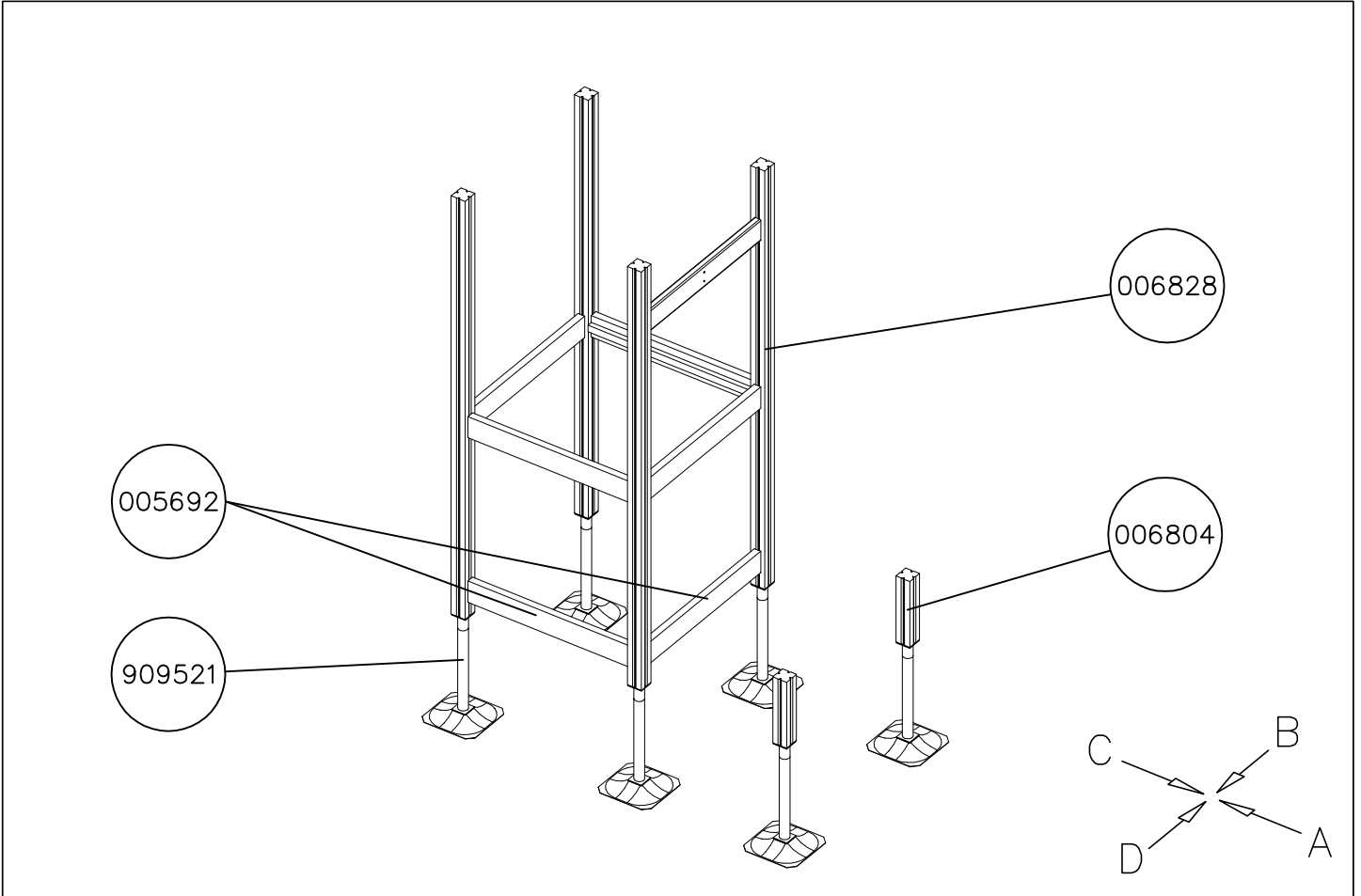

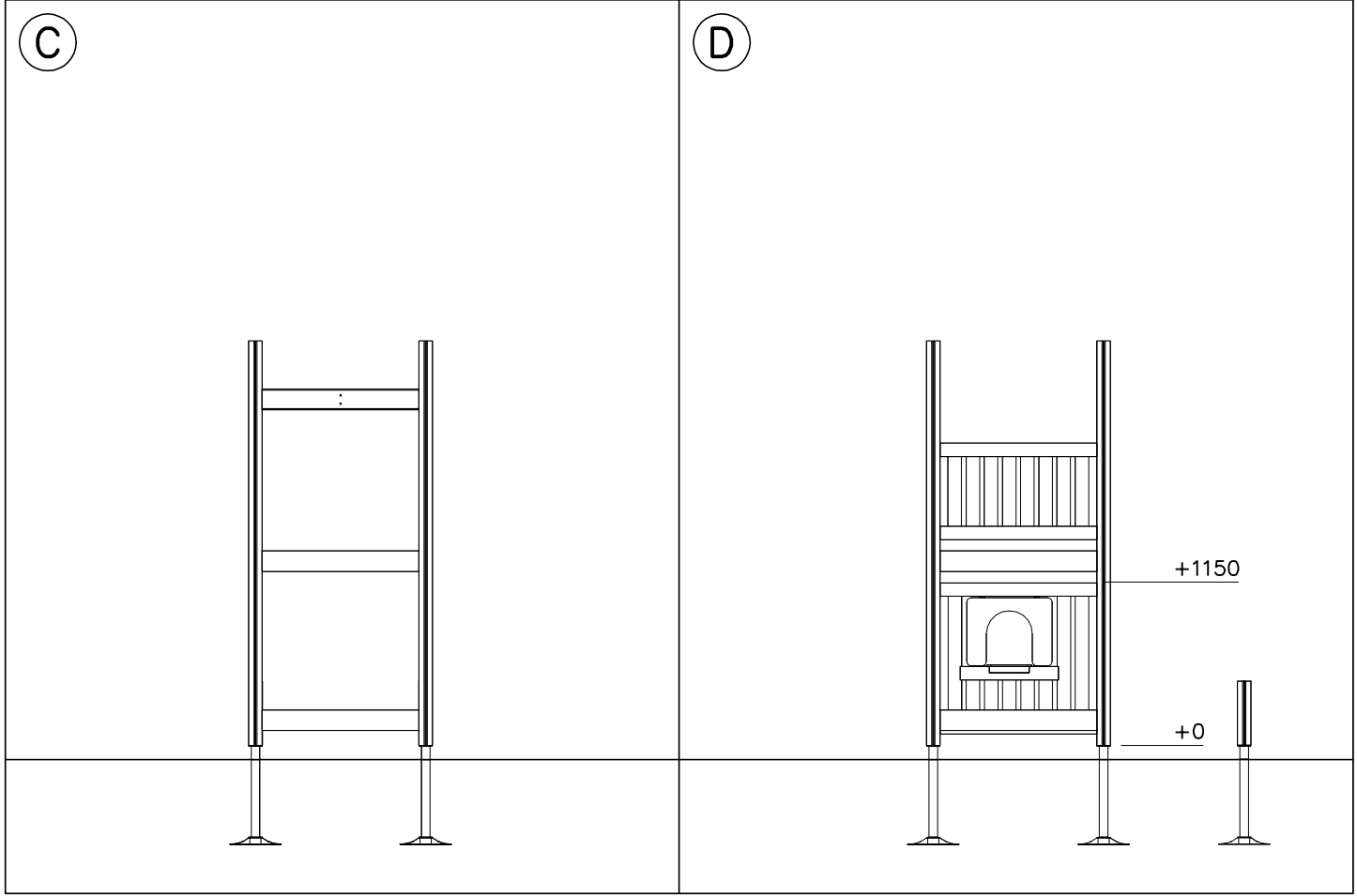
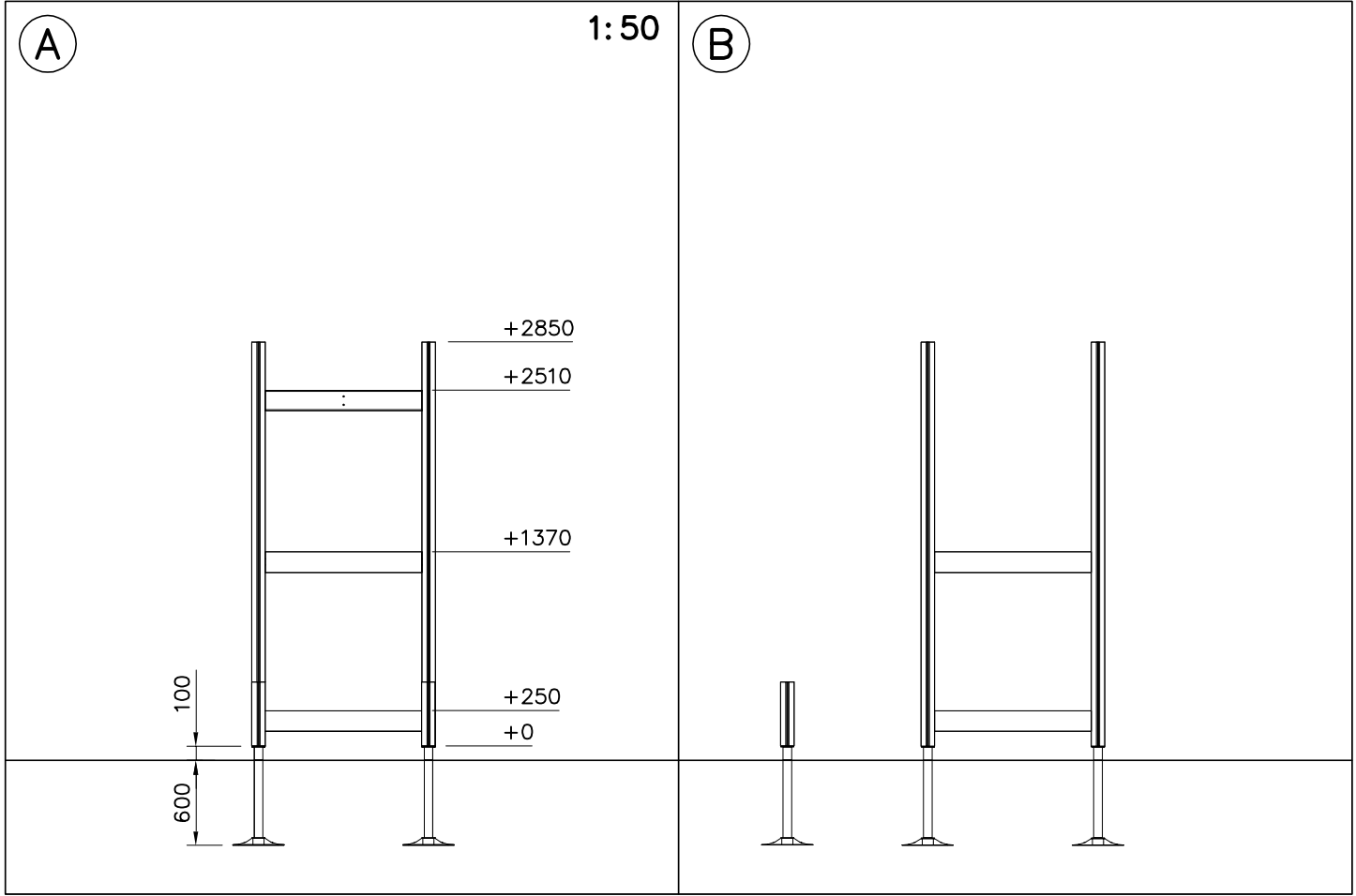

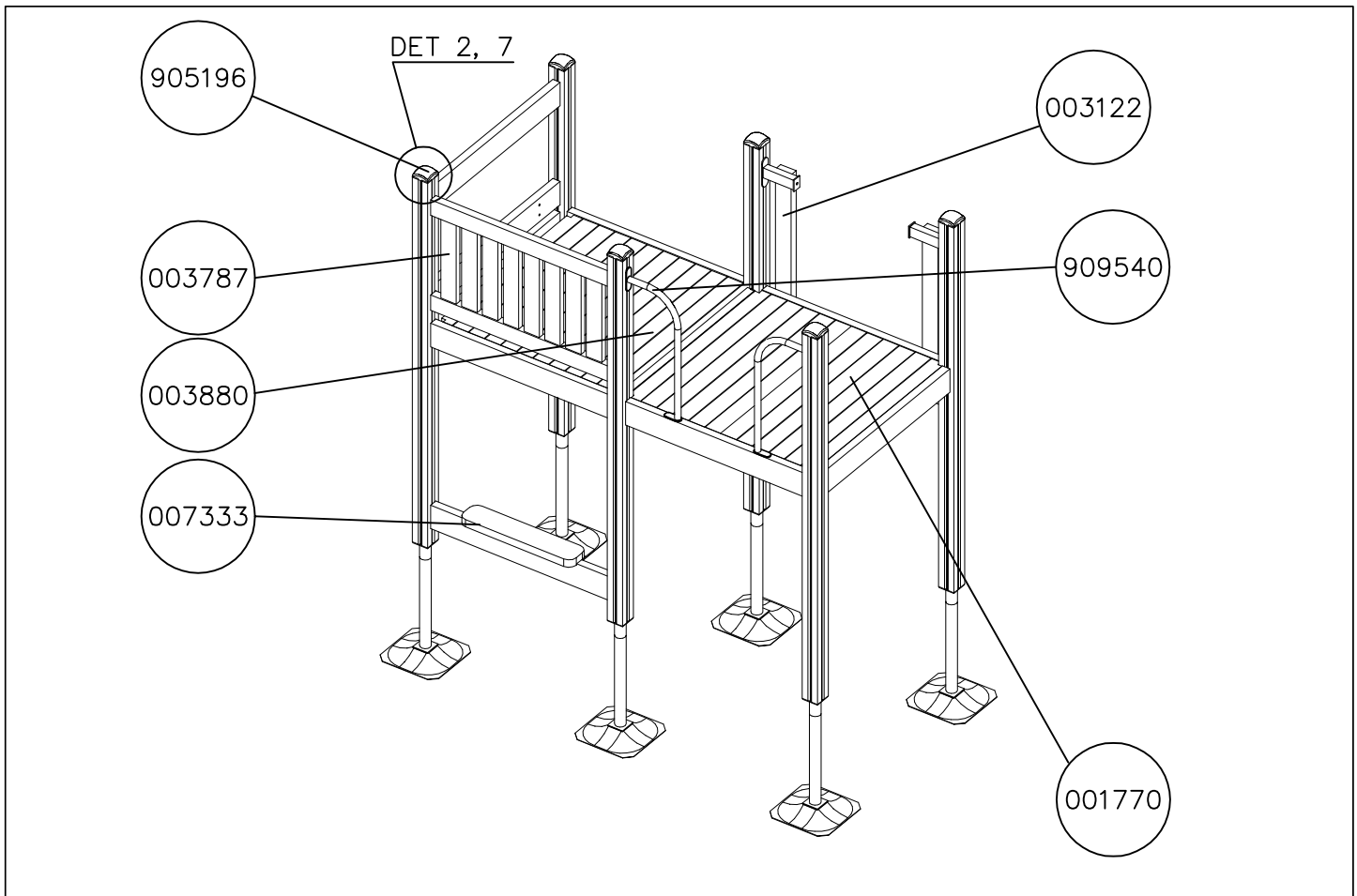
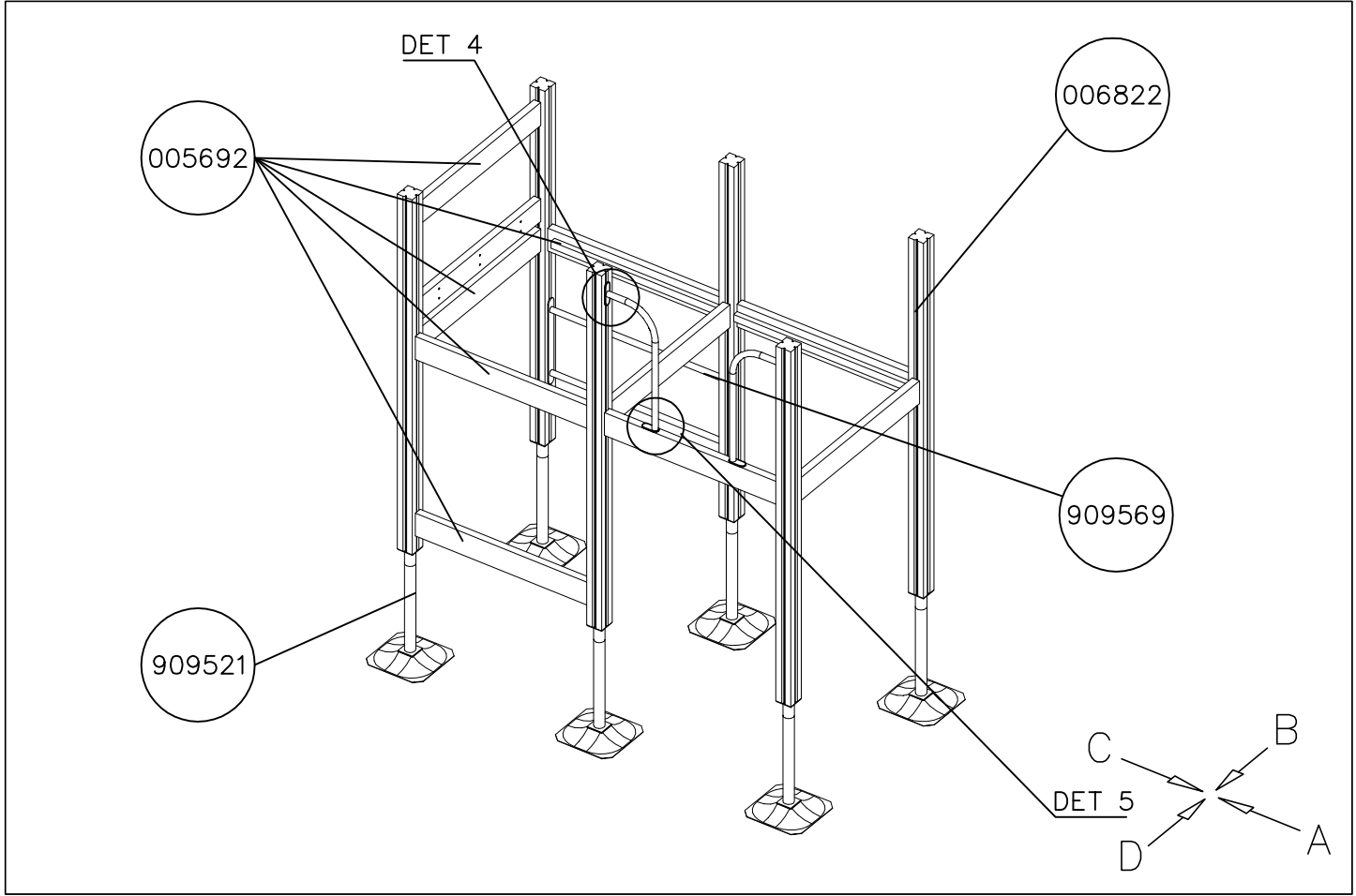

1: 50

(A)

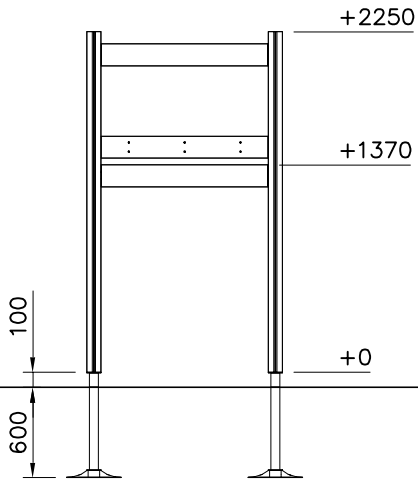

(B)

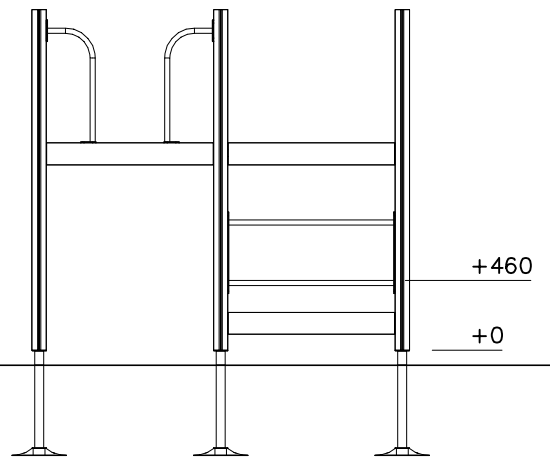

(C)

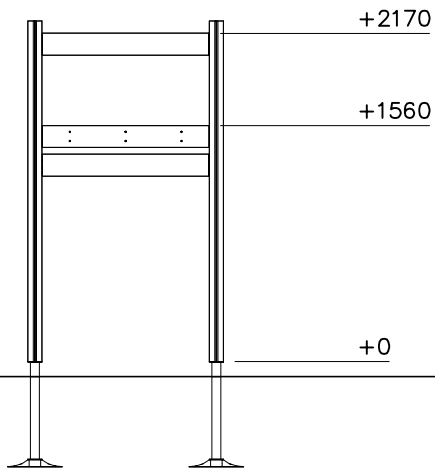

(D)

