

LAPPSET®

FINNO

ASENNUSOHJE
MONTERINGSANSVISNING
INSTALLATION INSTRUCTION
AUFBAUANLEITUNG
NOTICE D'INSTALLATION

REF: 122052
DATE: 1.4.2005

122052

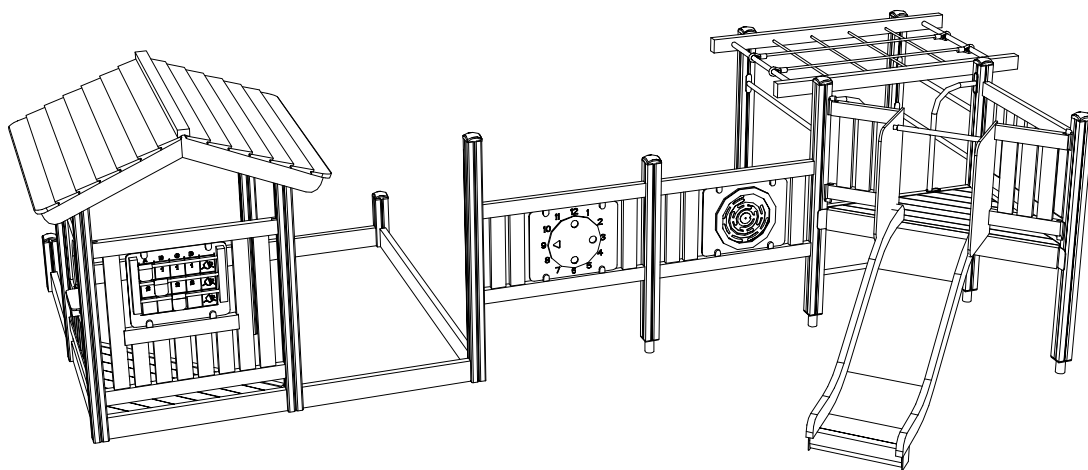

002781	PCS 1	003011	PCS 1	003618	PCS 1	003700	PCS 2	003787	PCS 1	003798	PCS 2
									BLUE		
003886	PCS 2	005271	PCS 1	005272	PCS 1	005273	PCS 1	005277	PCS 1	005285	PCS 1
005610	PCS 2	005692	PCS 6	005693	PCS 2	005735	PCS 2	006812	PCS 1	006816	PCS 5
		L 1104		L 2303		L 600		L 1250		L 1650	
006822	PCS 5	007841	PCS 1	900240	PCS 22	905051	PCS 32	905087	PCS 4	905104	PCS 24
L 2250				8x70		Ø24/8.4		Ø45		M10	
905120	PCS 30	905138	PCS 9	905196	PCS 9	909105	PCS 4	909224	PCS 4	909238	PCS 32
Ø14		GREY		GREY		M12x150		12x100		8x90	
909248	PCS 4	909521	PCS 6	909540	PCS 2	909542	PCS 4	980131	PCS 36	980154	PCS 4
M12						L 1104		6x60		Ø24/13	
	PCS		PCS		PCS		PCS		PCS		PCS

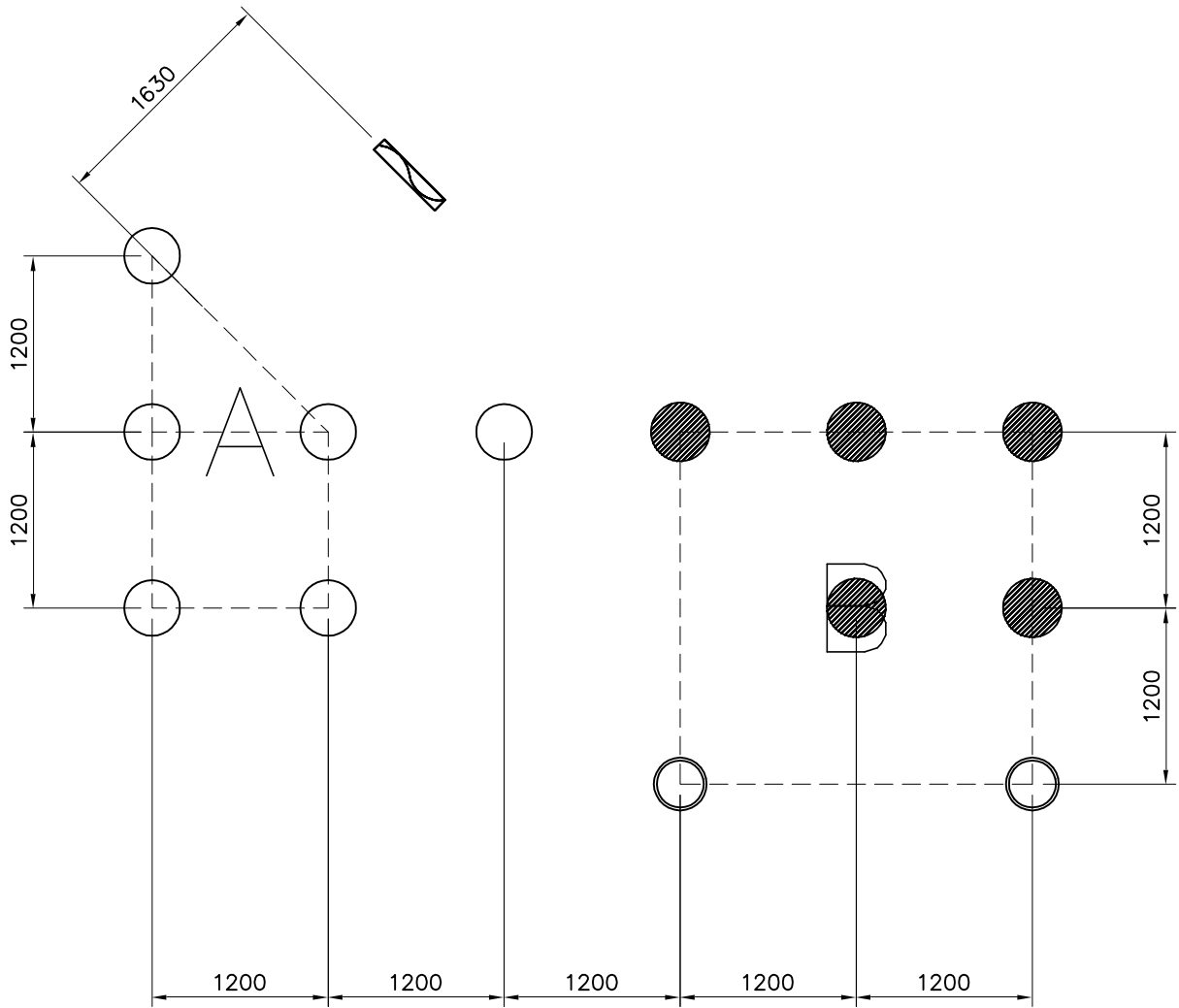
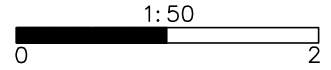

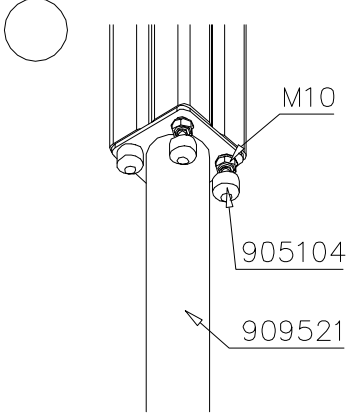
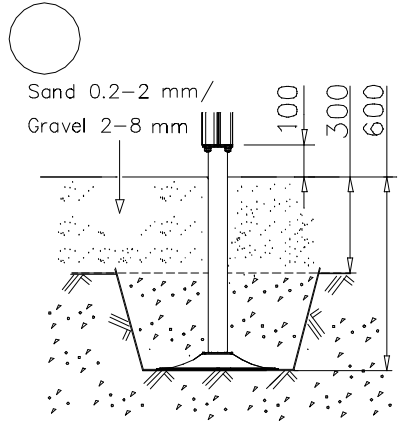
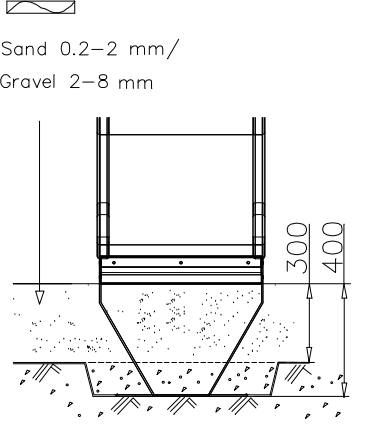
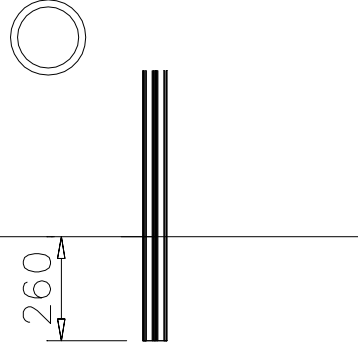
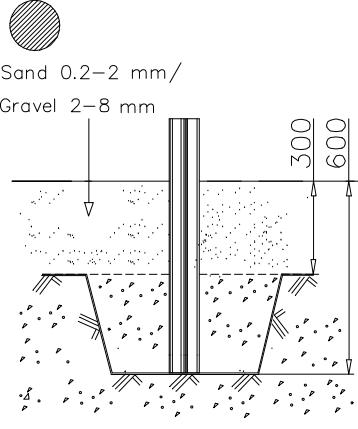
 <p>M10 905104 909521</p>	 <p>Sand 0.2–2 mm/ Gravel 2–8 mm</p> <p>100 300 600</p>	 <p>Sand 0.2–2 mm/ Gravel 2–8 mm</p> <p>300 400</p>
 <p>260</p>	 <p>Sand 0.2–2 mm/ Gravel 2–8 mm</p> <p>300 600</p>	

EN Impact Area 29.1 m²

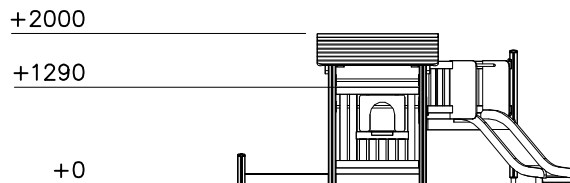
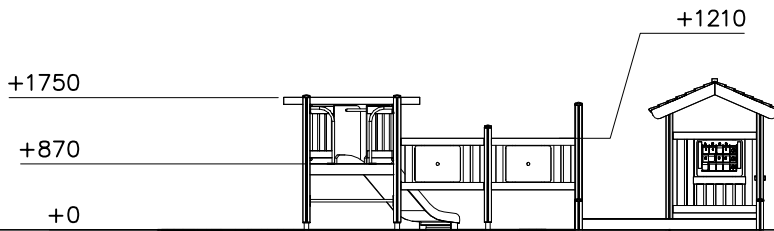
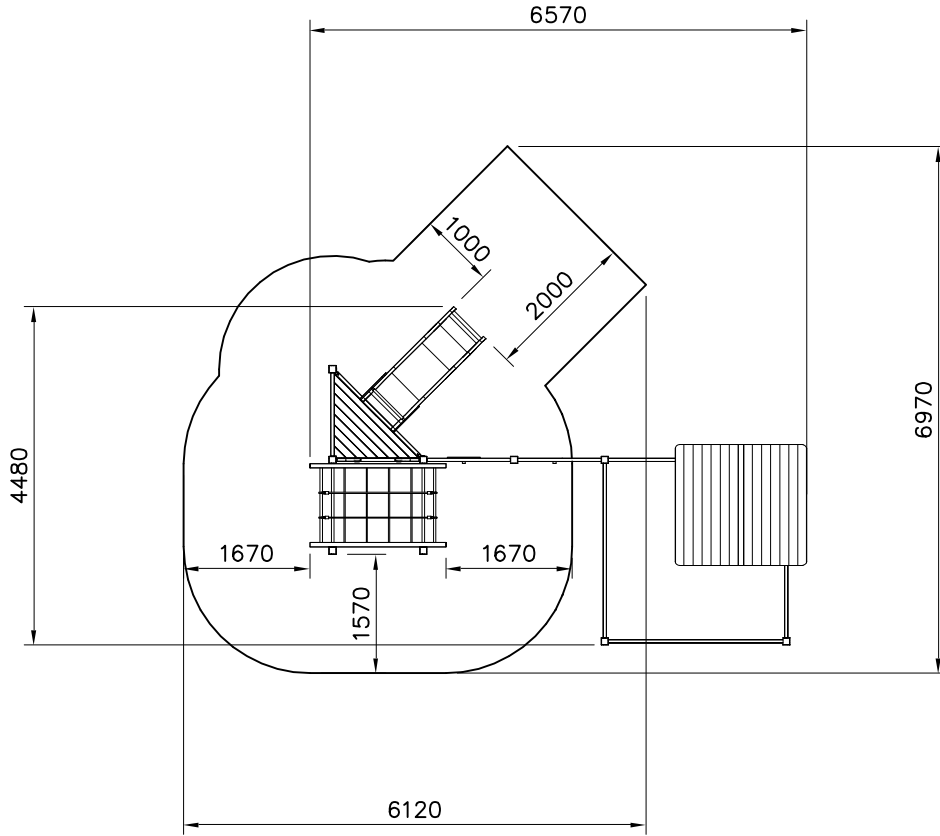
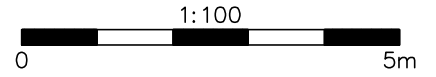

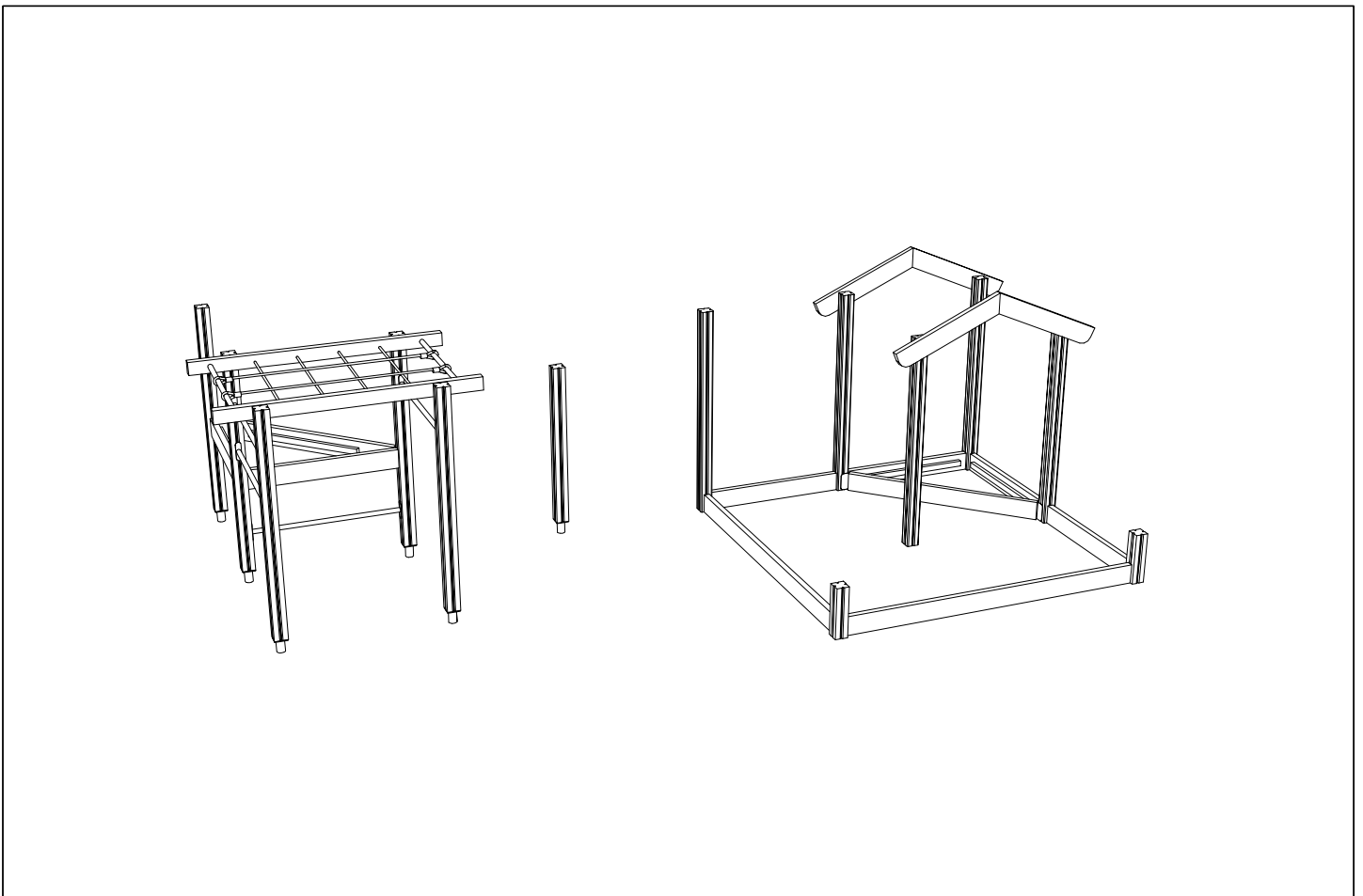
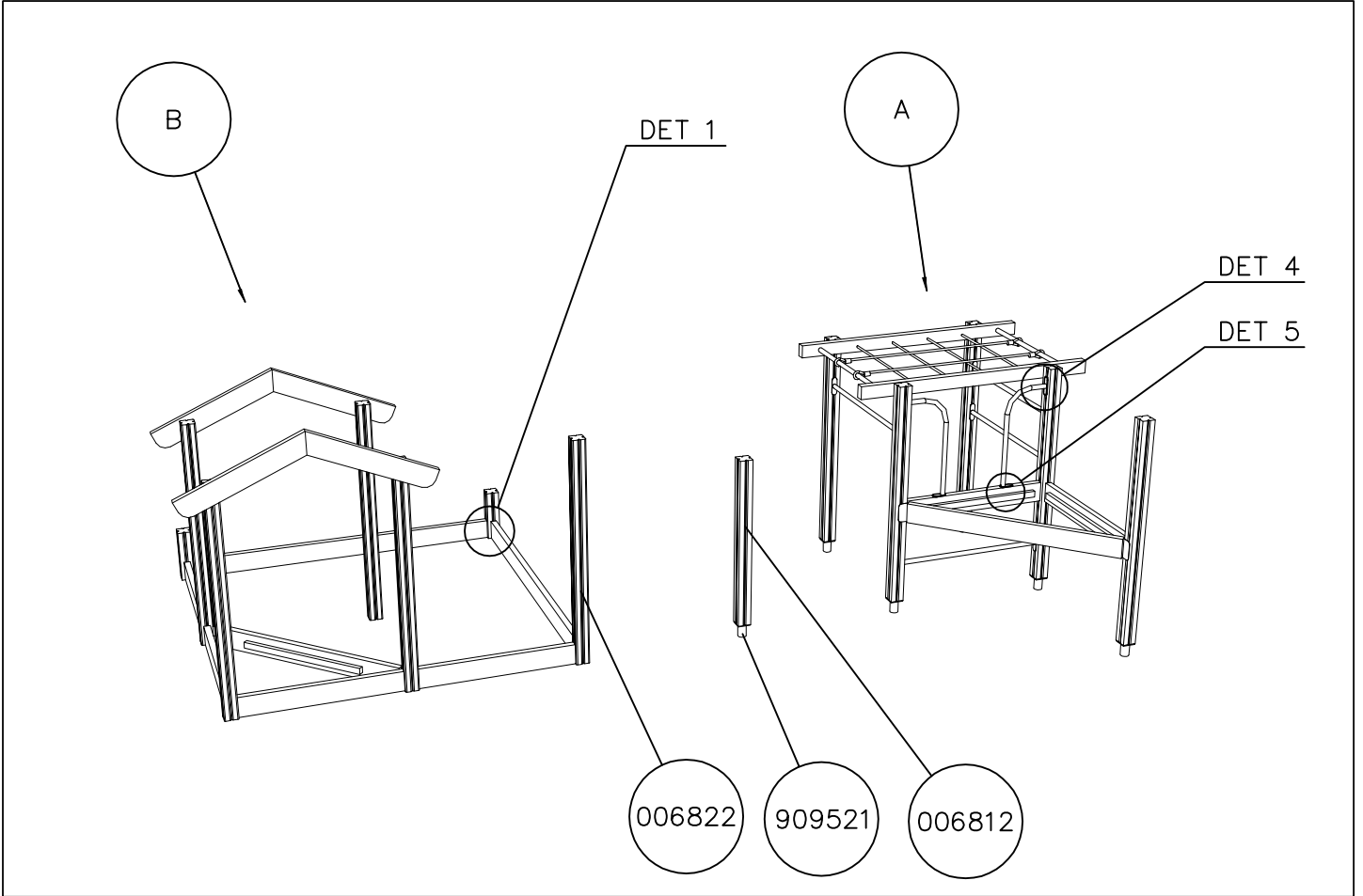

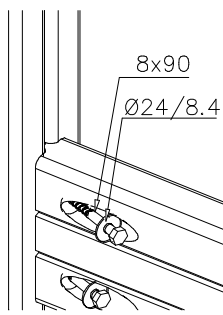
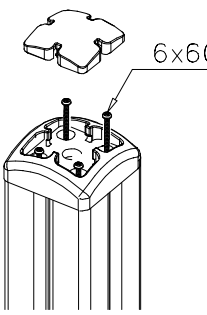
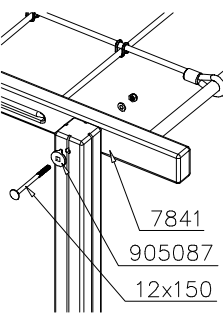
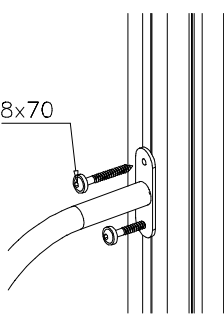
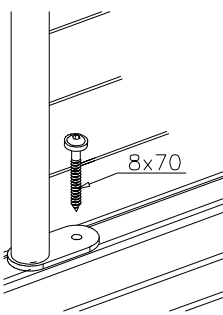
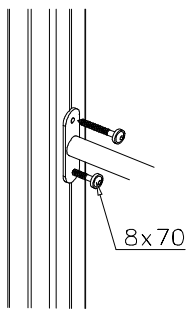
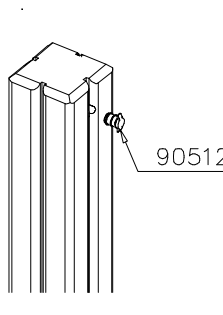
<p>DET 1</p>  <p>8x90 Ø24/8.4</p>	<p>DET 2</p>  <p>6x60</p>	<p>DET 3</p>  <p>7841 905087 12x150</p>	<p>DET 4</p>  <p>8x70</p>
<p>DET 5</p>  <p>8x70</p>	<p>DET 6</p>  <p>8x70</p>	<p>DET 7</p>  <p>905120</p>	

