

LAPPSET®









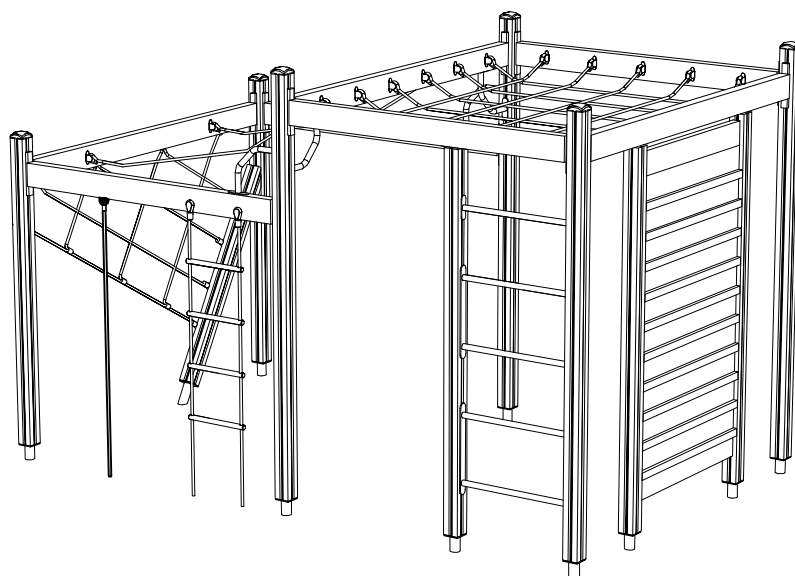

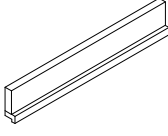
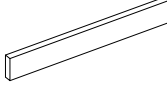





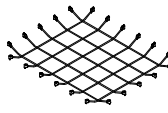
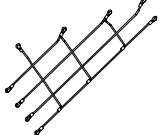

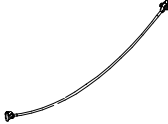
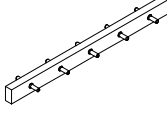
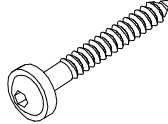





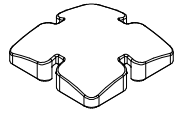
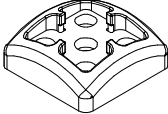
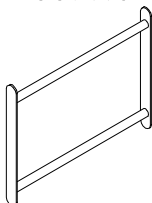
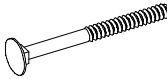
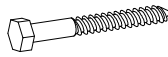

FINNO

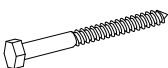
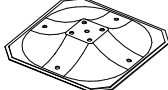
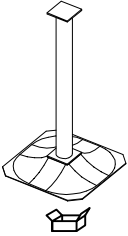
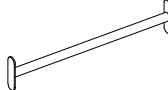
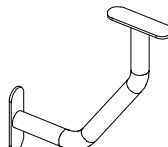
ASENNUSOHJE
MONTERINGSANSVISNING
INSTALLATION INSTRUCTION
AUFBAUANLEITUNG
NOTICE D'INSTALLATION

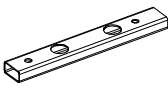
REF: 121110
DATE: 1.4.2005

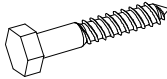
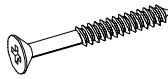
121110



005607  L 1104	PCS 10	005692  L 1104	PCS 2	006800  L 1530	PCS 1	006819  L 1950	PCS 2	006822  L 2250	PCS 3	006825  L 2550	PCS 4
006931  L 1860	PCS 3	006932  L 2260	PCS 3	006941  8x70	PCS 1	006942  Ø24/8.5	PCS 1	006961  Ø32	PCS 1	006964  SR-H-2040	PCS 1
006968  L 2030	PCS 2	006970  L 1860	PCS 1	900240  8x70	PCS 44	905051  Ø24/8.5	PCS 50	905083  Ø32	PCS 52	905102  SR-H-2040	PCS 28
905103  PT-28/32-H	PCS 28	905104  M10	PCS 40	905112  Ø22	PCS 63	905120  Ø14	PCS 18	905138  GREY	PCS 6	905196  GREY	PCS 6
907119  L 704	PCS 2	909126  8x90	PCS 57	909217  8x70	PCS 6	909231  8x130	PCS 1	909233  8x100	PCS 1	909238  8x90	PCS 48
909519  909578	PCS 1	909521  909521	PCS 10	909543  L 704	PCS 1	909547  980131	PCS 4	909574  6x40x200	PCS 3	909578  909578	PCS 14
909638  Ø20/10.5	PCS 28	909862  10x60	PCS 28	980100  5x60	PCS 12	980131  6x60	PCS 24	980150  M8	PCS 57	980151  Ø16/8.4	PCS 63

905122  Ø10	PCS		PCS		PCS		PCS		PCS		PCS
	44										
	PCS		PCS		PCS		PCS		PCS		PCS
	PCS		PCS		PCS		PCS		PCS		PCS
	PCS		PCS		PCS		PCS		PCS		PCS
	PCS		PCS		PCS		PCS		PCS		PCS

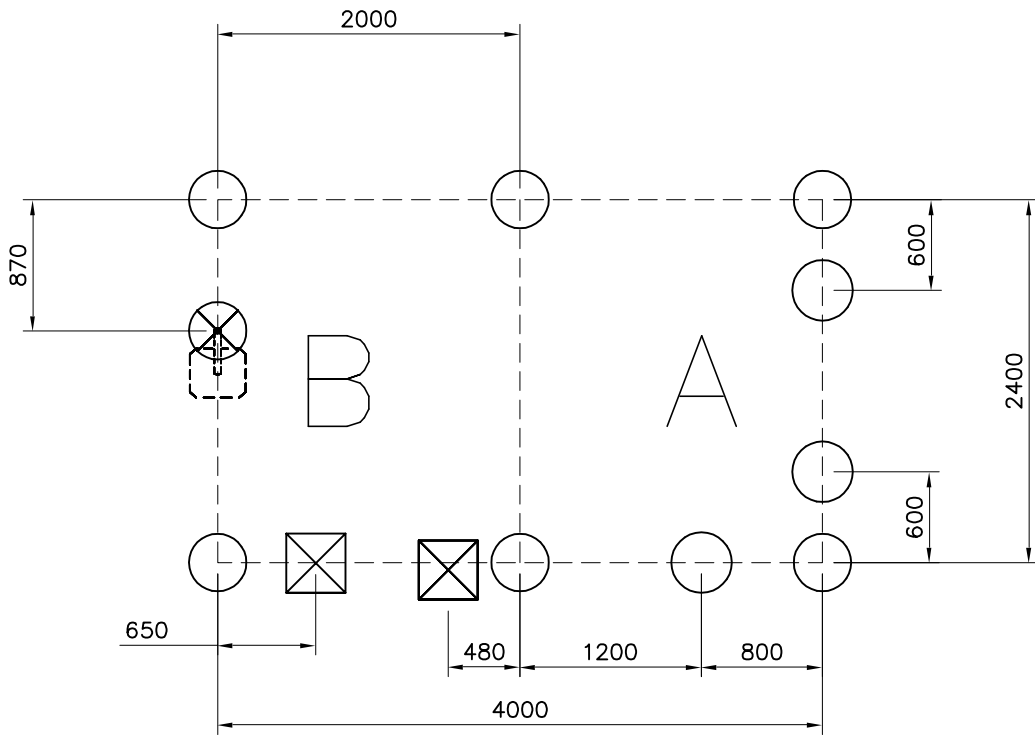
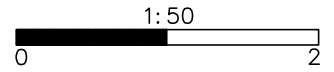

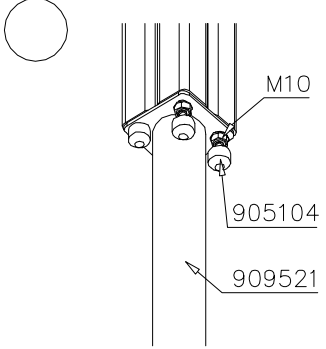
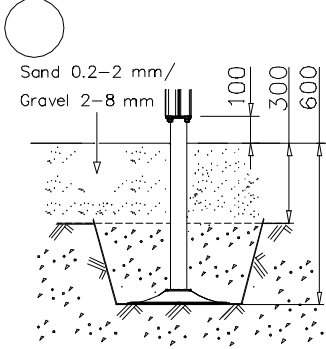
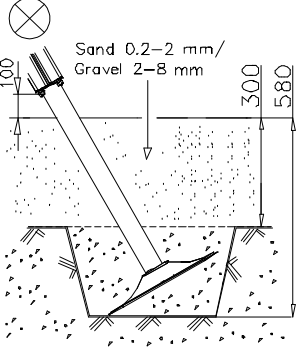
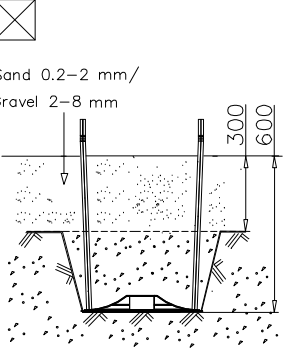
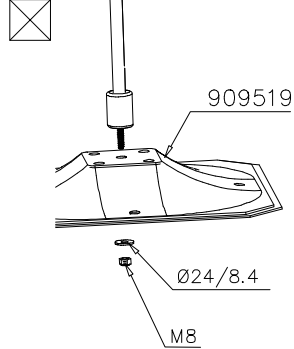
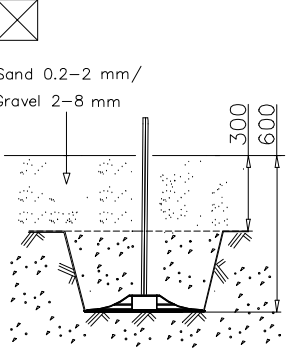
 <p>M10 905104 909521</p>	 <p>Sand 0.2–2 mm/ Gravel 2–8 mm</p> <p>100 300 600</p>	 <p>Sand 0.2–2 mm/ Gravel 2–8 mm</p> <p>100 300 580</p>
 <p>Sand 0.2–2 mm/ Gravel 2–8 mm</p> <p>300 600</p>	 <p>909519 Ø24/8.4 M8</p>	 <p>Sand 0.2–2 mm/ Gravel 2–8 mm</p> <p>300 600</p>

EN Impact Area 48.2 m²

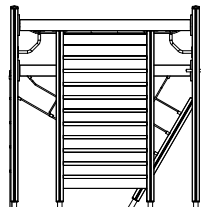
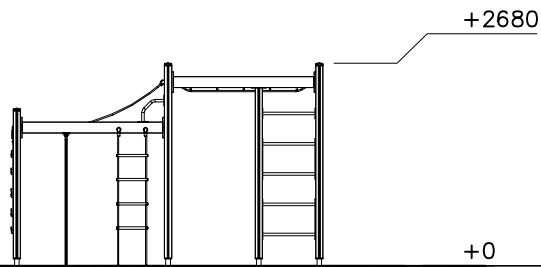
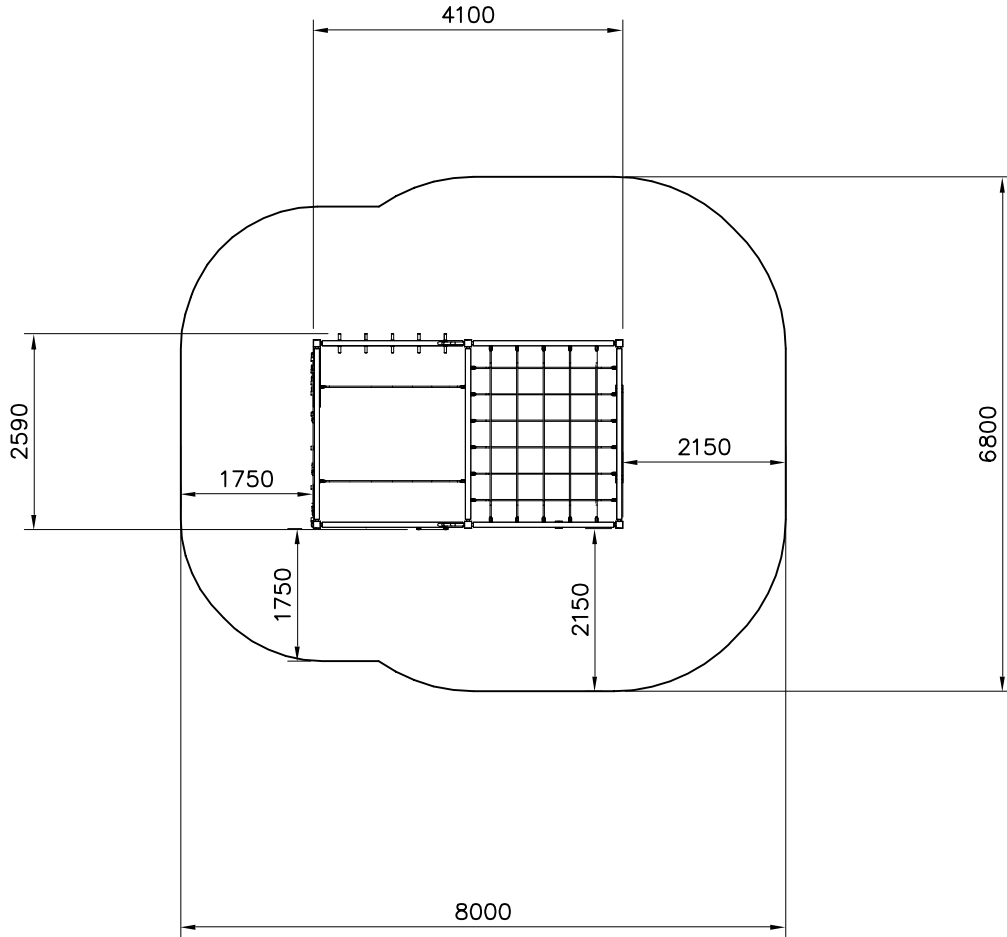
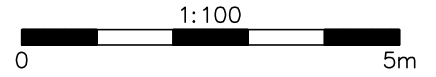

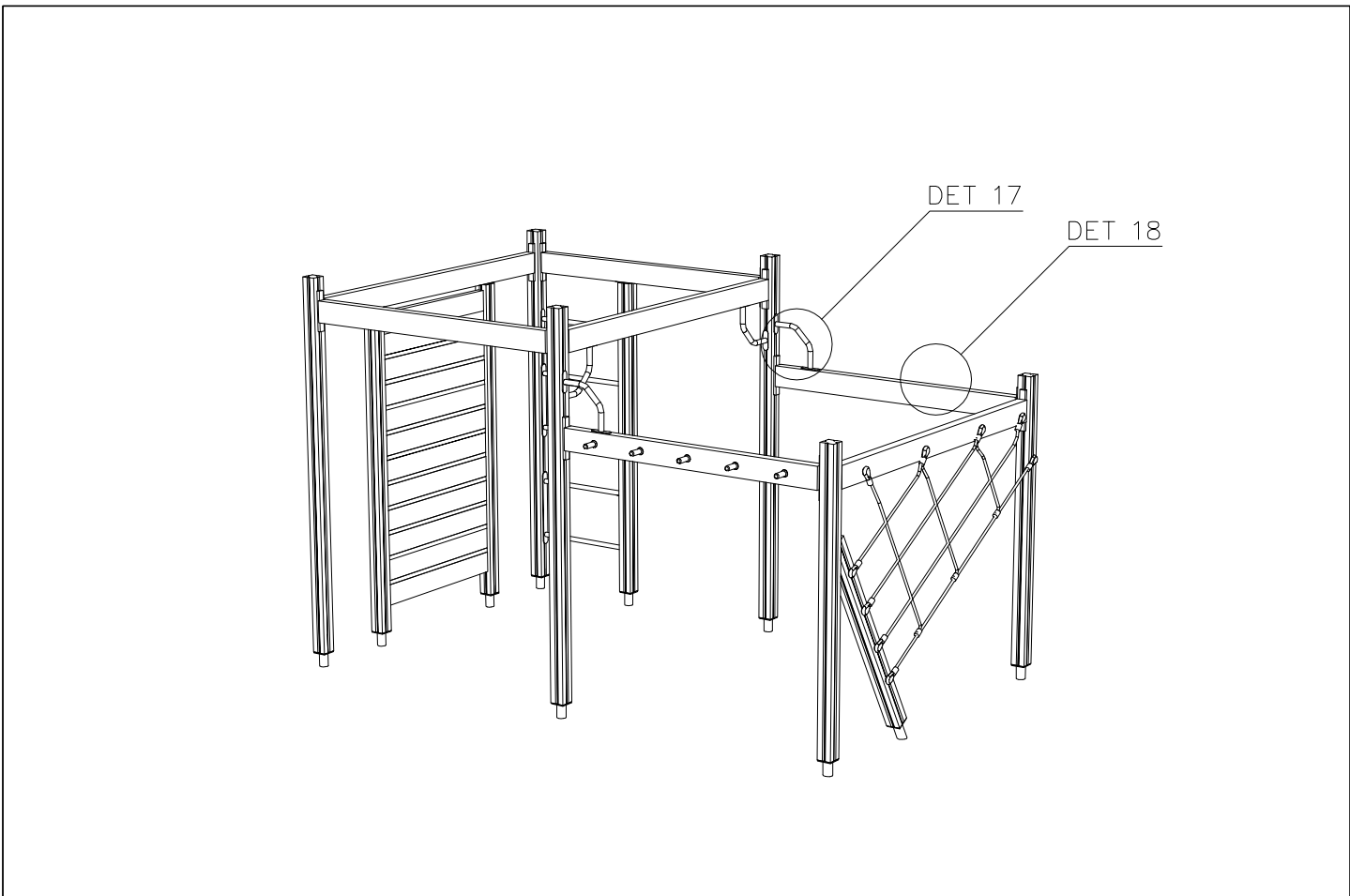
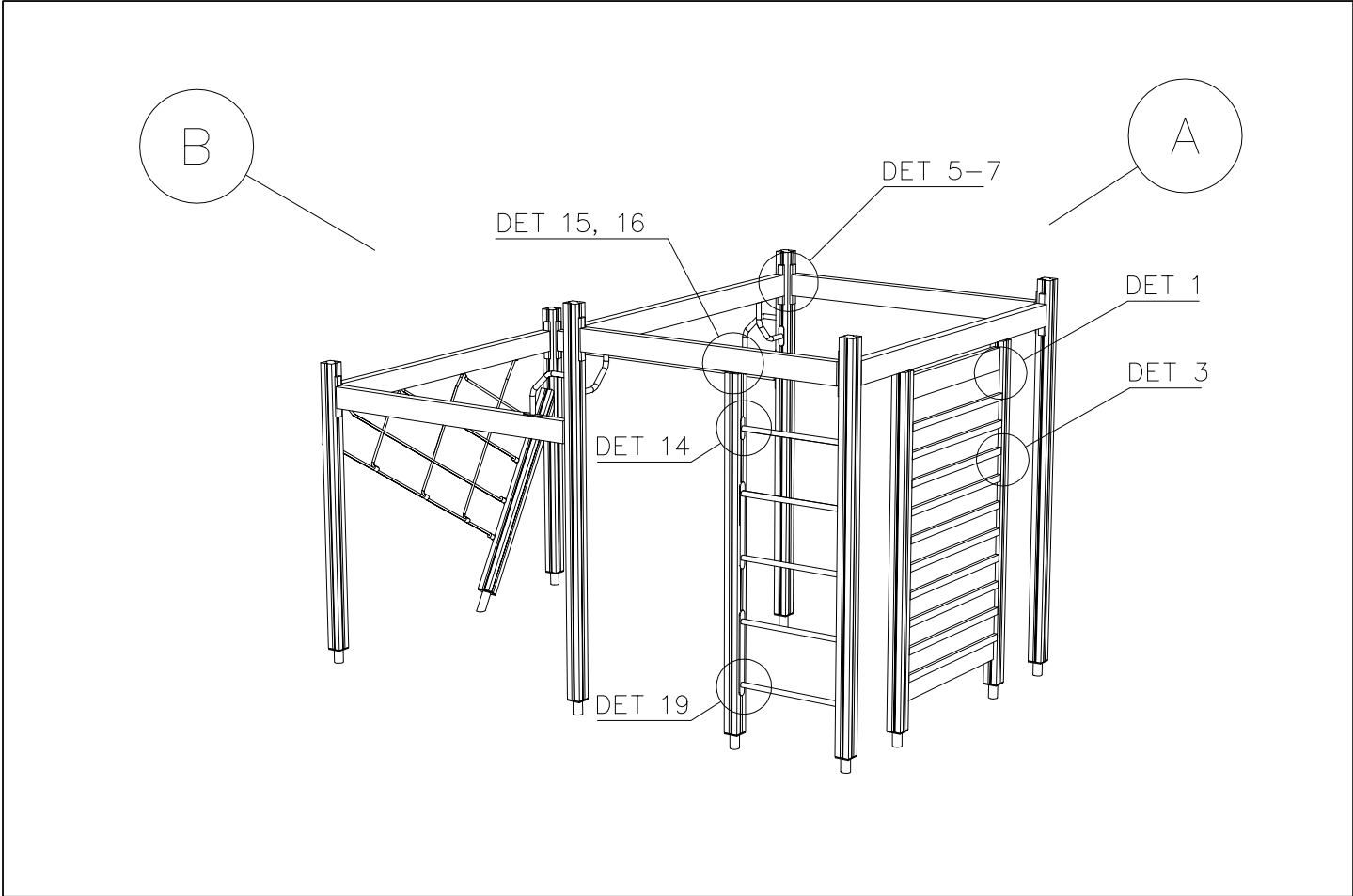

<p>DET 1</p>	<p>DET 2</p>	<p>DET 3</p>	<p>DET 4</p>
<p>DET 5</p>	<p>DET 6</p>	<p>DET 7</p>	<p>DET 8</p>
<p>DET 9</p>	<p>DET 10</p>	<p>DET 11</p>	<p>DET 12</p>
<p>DET 13</p>	<p>DET 14</p>	<p>DET 15</p>	<p>DET 16</p>
<p>DET 17</p>	<p>DET 18</p>	<p>DET 19</p>	<p>DET 20</p>

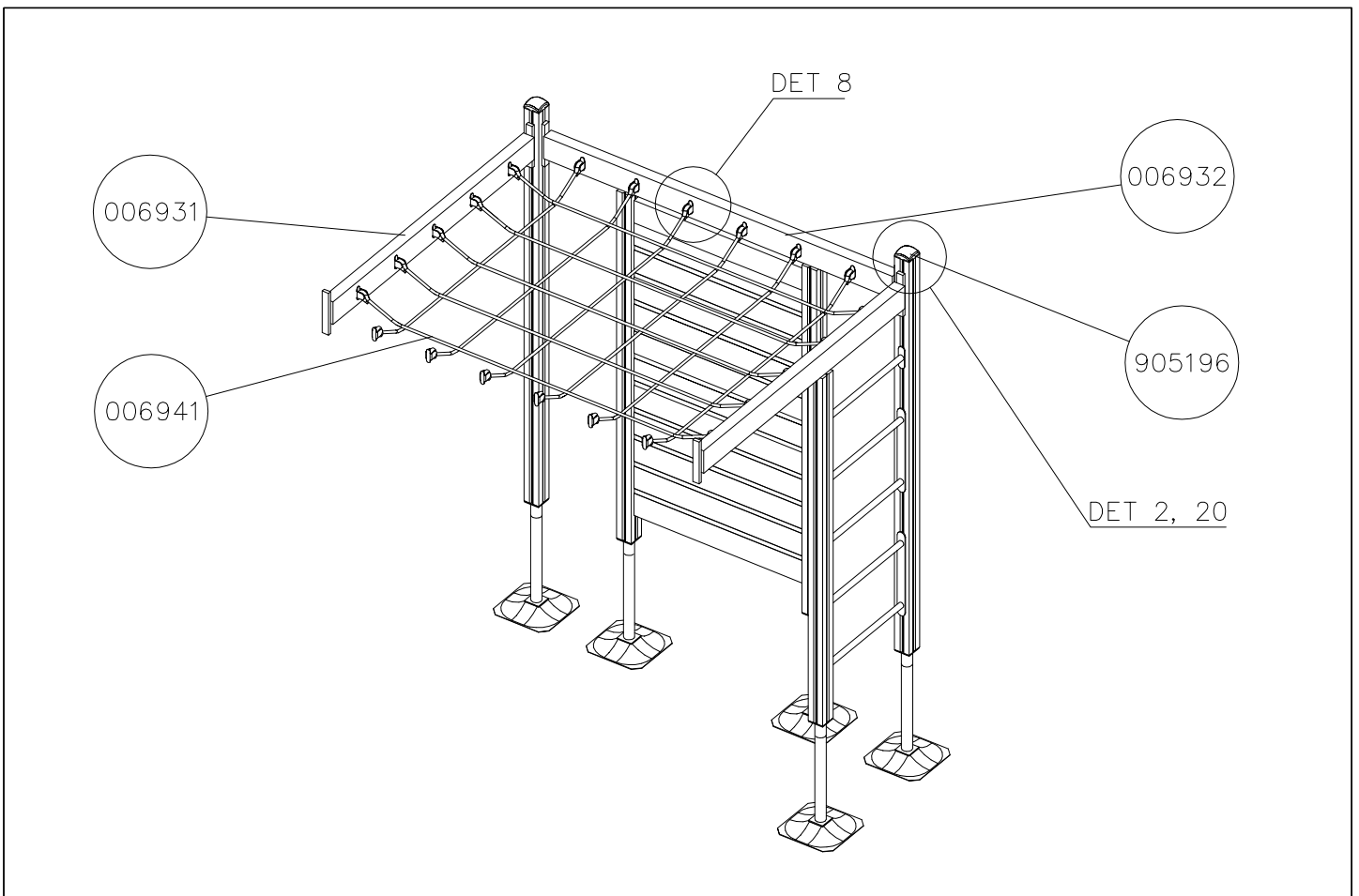
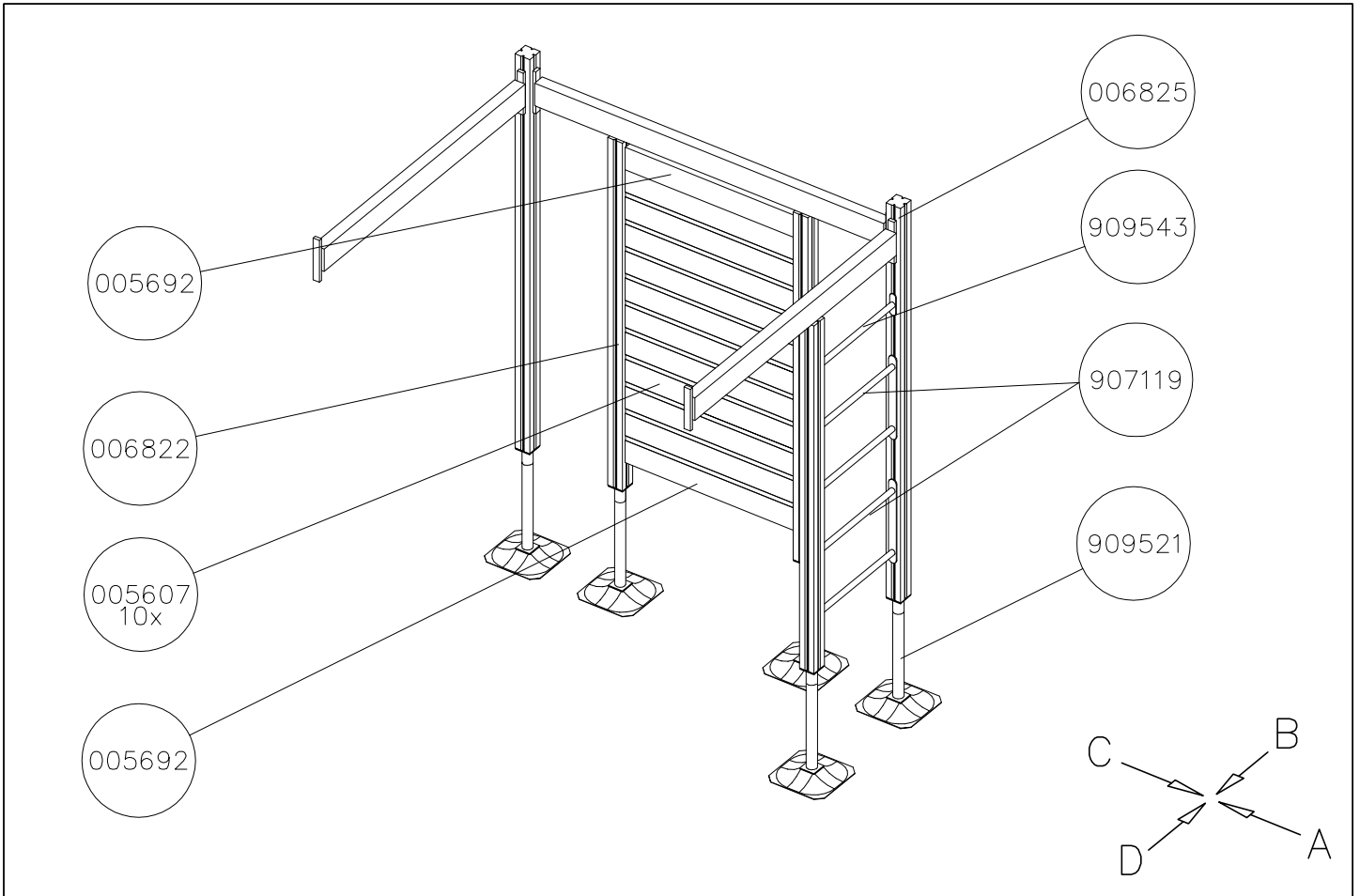

1:50

(A)

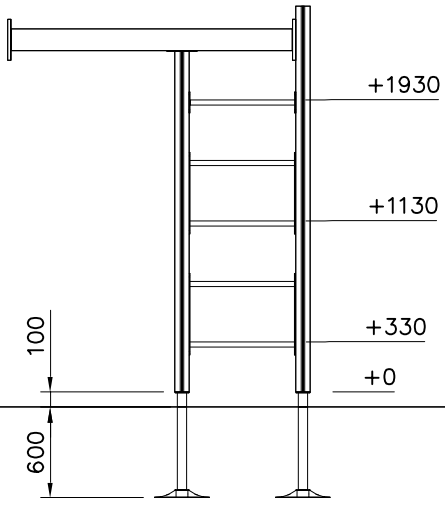

(B)

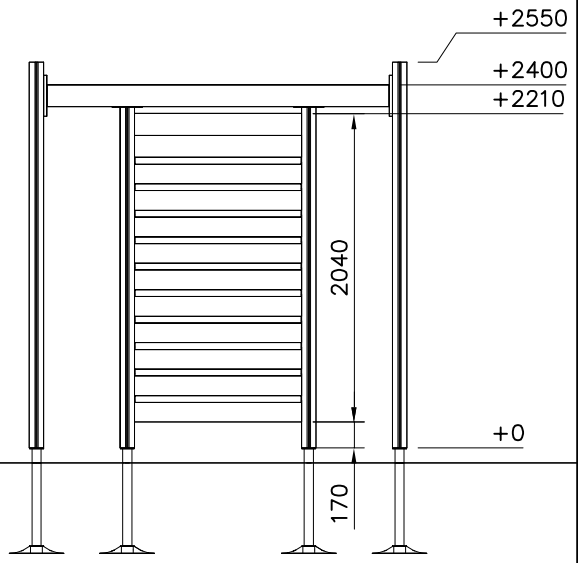

(C)

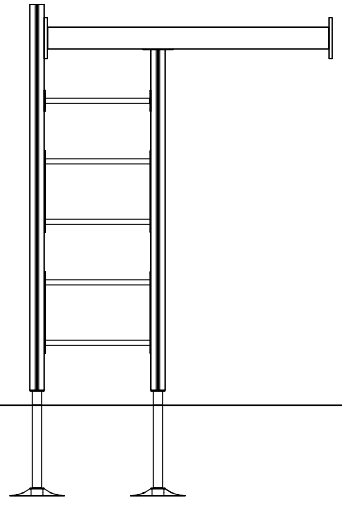

(D)

