

LAPPSET®

FINNO









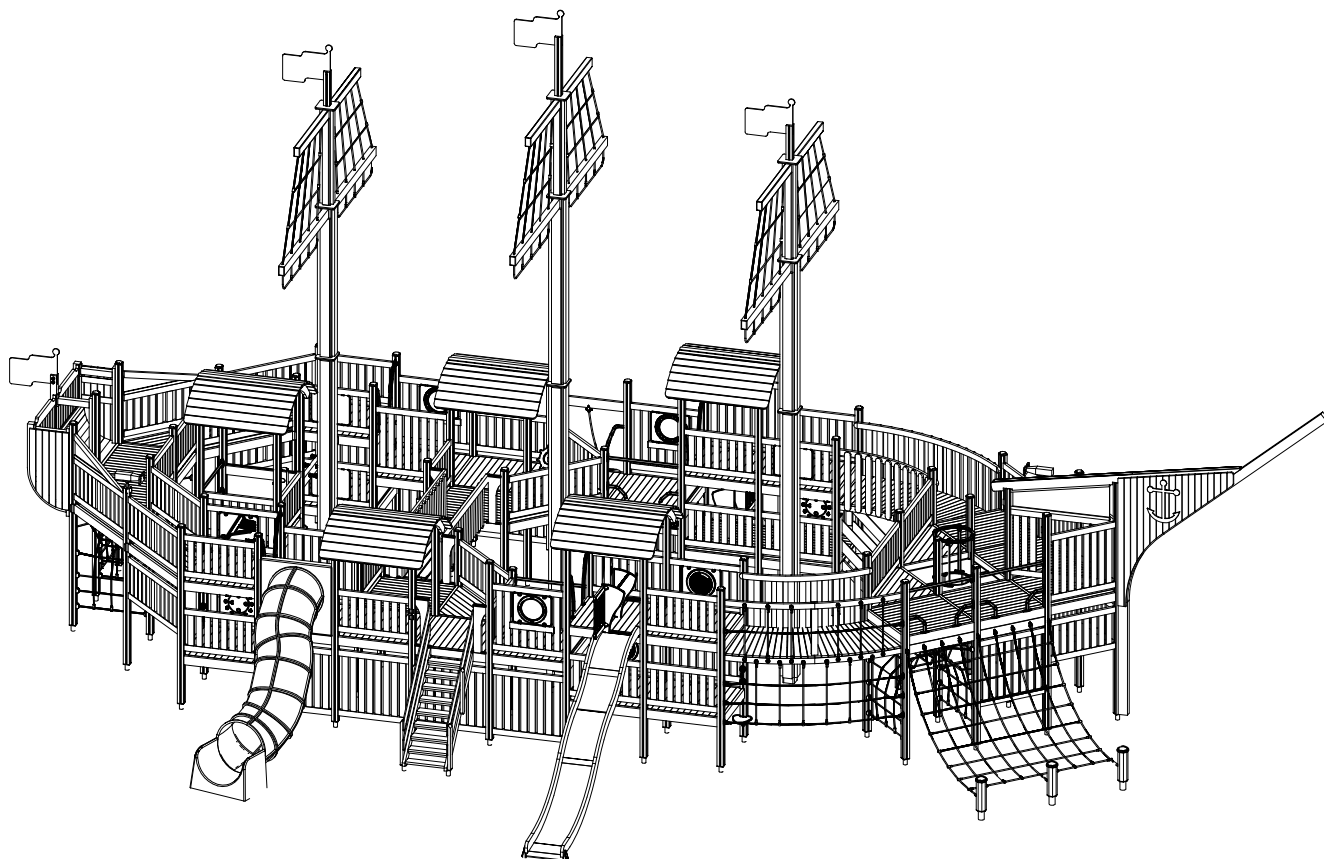





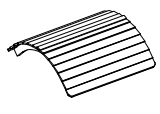

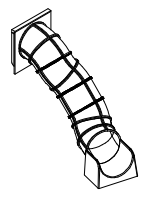

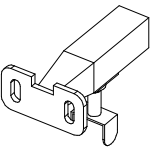

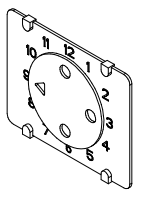

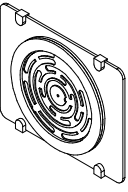

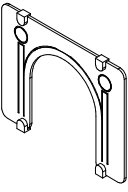

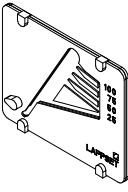

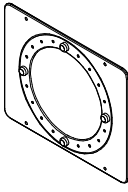

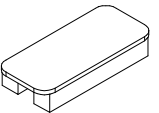



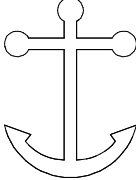

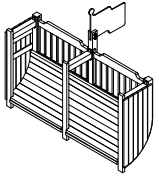

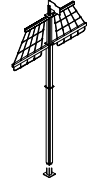



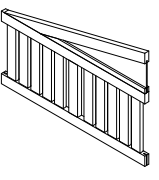

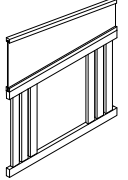

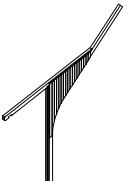

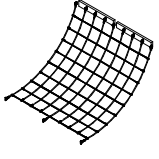

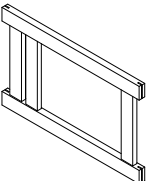

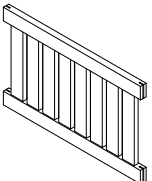

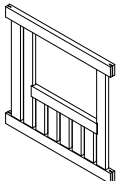

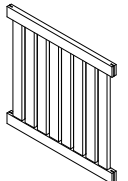

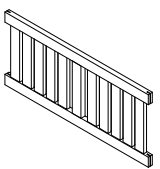



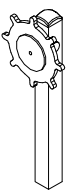

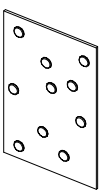

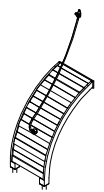

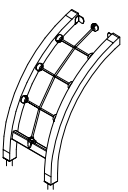







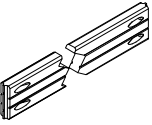





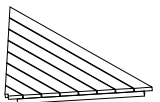

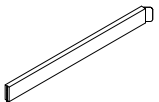
ASENNUSOHJE
MONTERINGSANSVISNING
INSTALLATION INSTRUCTION
AUFBAUANLEITUNG
NOTICE D'INSTALLATION

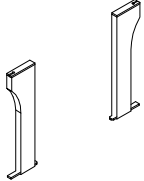

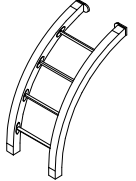

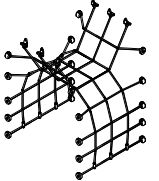

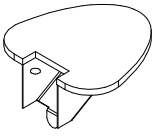



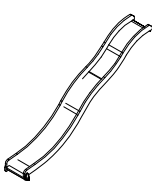

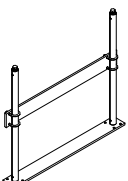



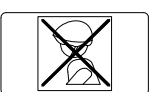

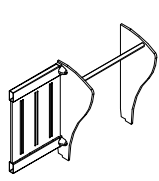

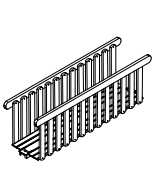

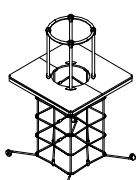

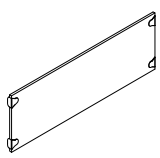

REF: 120835
DATE: 22.4.2015

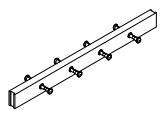
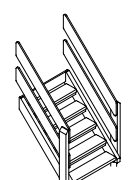
120835

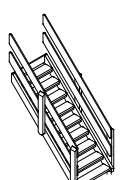
INCLUDE PRODUCTS WHICH
NEED EXPERT KNOWLEDGE
OF CONSTRUCTION TECHNIQUE

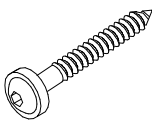

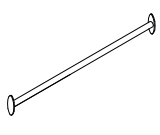
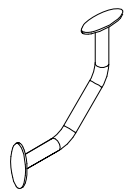
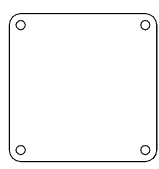
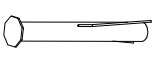
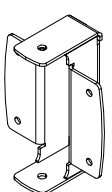
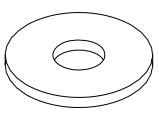
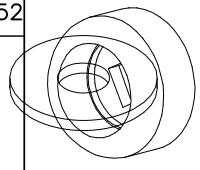
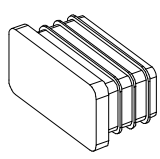
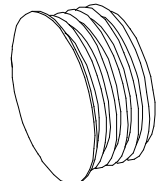
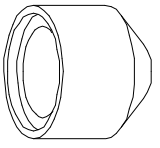
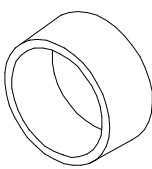
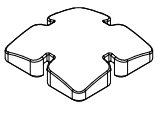
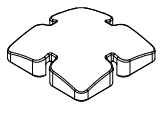
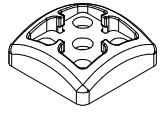
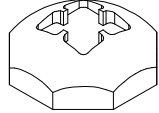
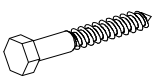
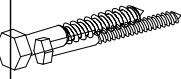
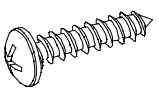
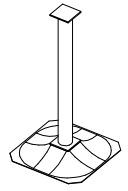
001825  	PCS 1	001826  	PCS 1	002780  	PCS 5	002927  	PCS 1	003974  	PCS 2	005271  	PCS 4
005272  	PCS 3	005273  	PCS 1	005275  	PCS 1	005282  	PCS 8	005285  	PCS 1	006827  L 3250 	PCS 3
007929  	PCS 2	007972  	PCS 1	007978  	PCS 2	007979  	PCS 1	007981  	PCS 2	007983  	PCS 1
007984  	PCS 1	007987  	PCS 1	007998  	PCS 8	007999  	PCS 26	008000  	PCS 9	008001  	PCS 10
008002  	PCS 11	009331  L 475 	PCS 3	011925  	PCS 2	700268  	PCS 1	701095  	PCS 1	701105  	PCS 1
701428  L 2250 	PCS 6	701434  L 2850 	PCS 36	701437  L 3450 	PCS 15	701482  L 1104 	PCS 113	701556  	PCS 1	701557  	PCS 30
701569  	PCS 10	701574  	PCS 10	701582  	PCS 4	701605  	PCS 1	701660  	PCS 3	701666  	PCS 3

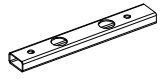
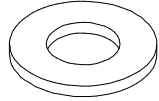
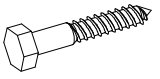
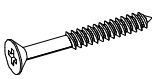
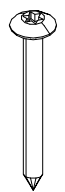
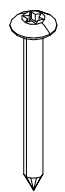
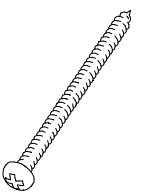
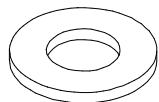
701672  1 	701928  2 	702286  1 	702339  1 	702572  2 	702700  1 	90x50	90x50	702722  1 	702792  3 	702943  8 	703160  1 L 1680	707201  1 	707202  1 	900240  212 8x70	901782  10	901785  8 L 1104	901798  10	902487  2 65x65	903112  3	903420  1	905051  452 Ø24/8.4	905083  12 Ø32	905102  2 SR-H-2040	905103  2 PT-28/32-H	905104  292 M10	905112  12 Ø22	905138  37 GRAY	905139  3 BLACK	905196  37 GRAY	905197  3 BLACK	909235  12 8x60	909238  452 8x90	909506  8 Ø3.5x13	909521  71 	909578  1	909638  2 Ø20/10.5	909862  2 10x60	980102  12 5x40	980123  36 Ø7x60	980128  24 Ø7x40	980131  160 Ø6x60	980151  12 Ø16/8.4
---	---	---	---	---	---	-------	-------	---	---	---	--	---	---	--	---	--	---	---	--	--	---	--	---	--	---	--	---	---	---	---	---	---	---	--	--	--	---	---	--	--	---	--

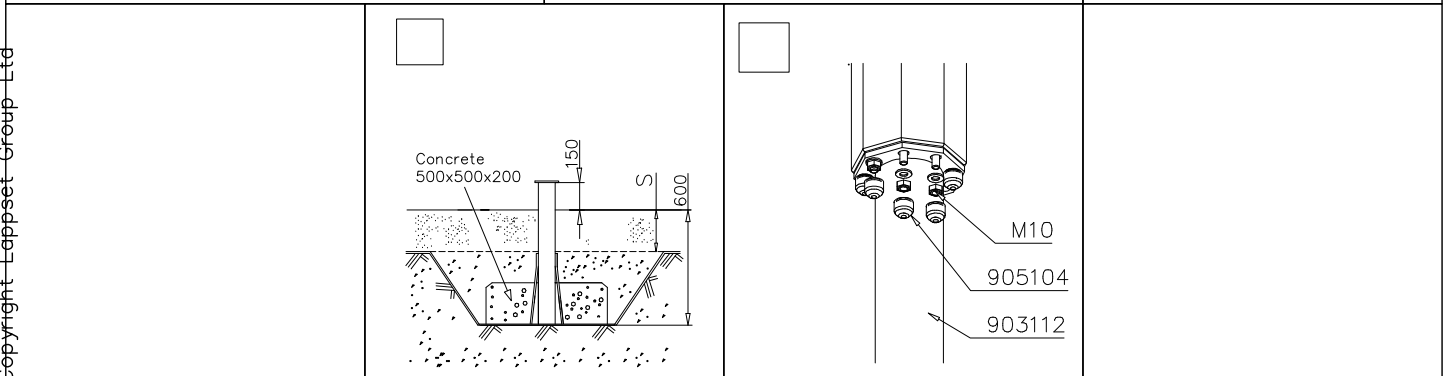
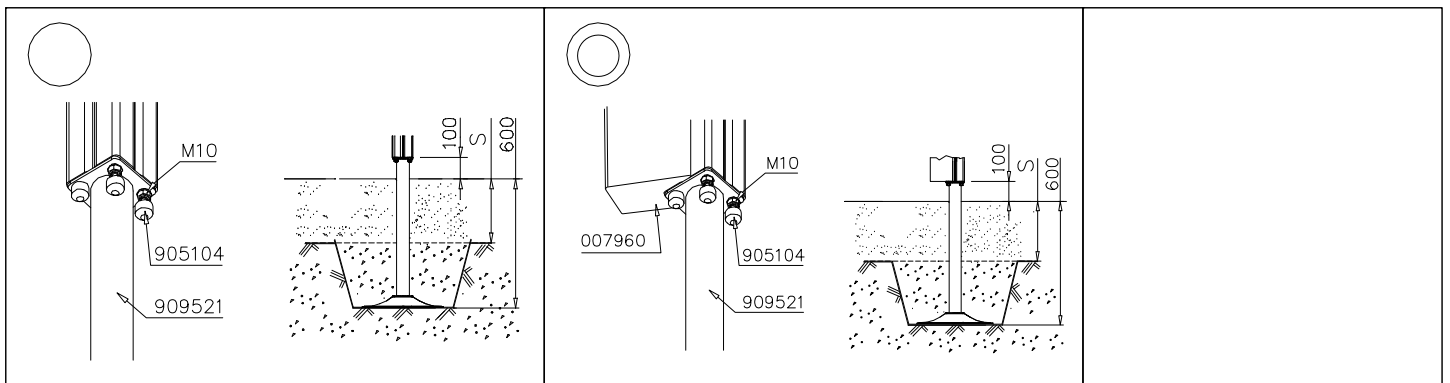
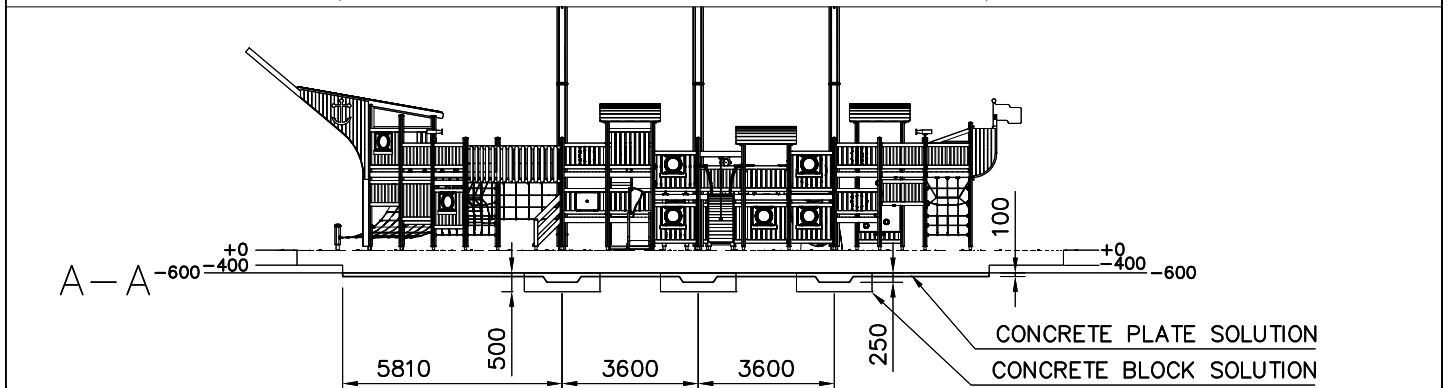
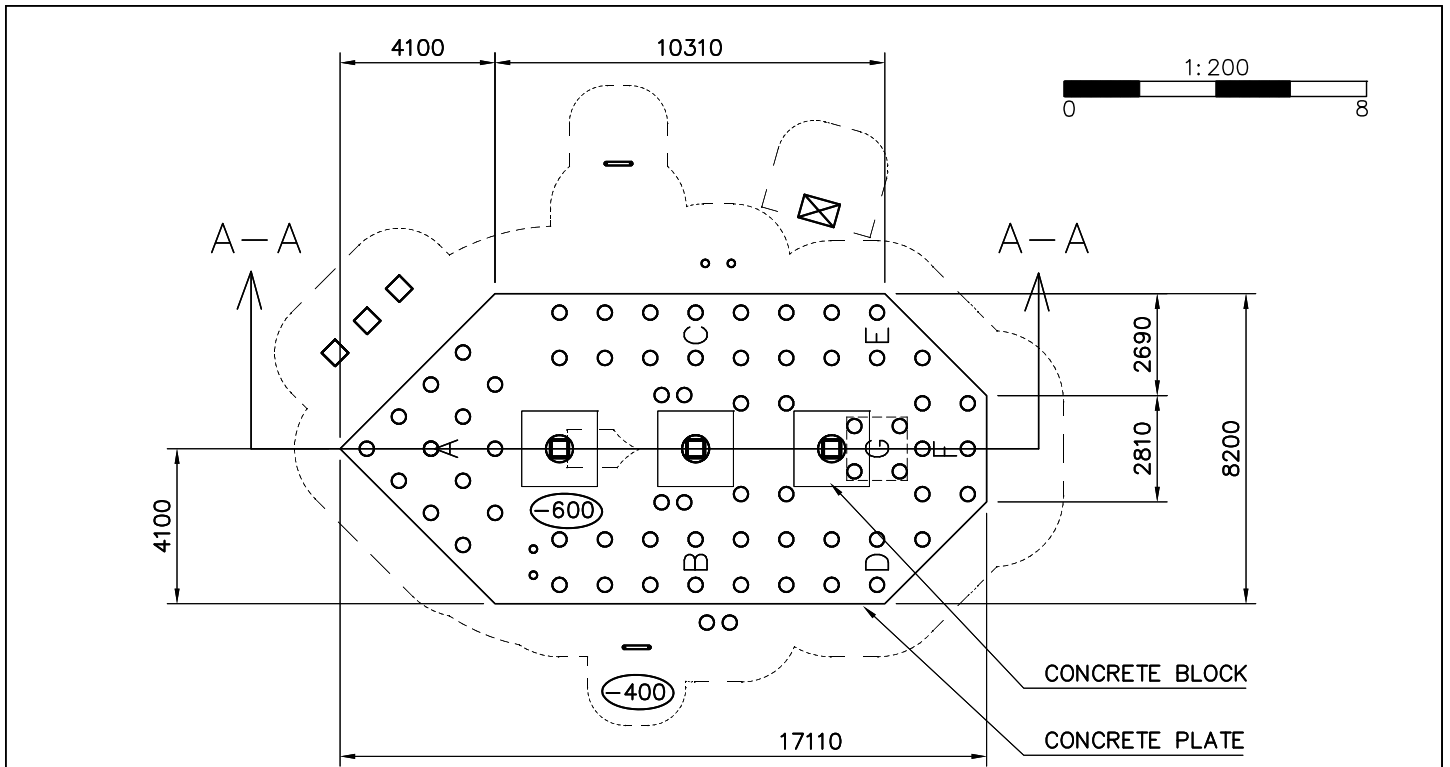

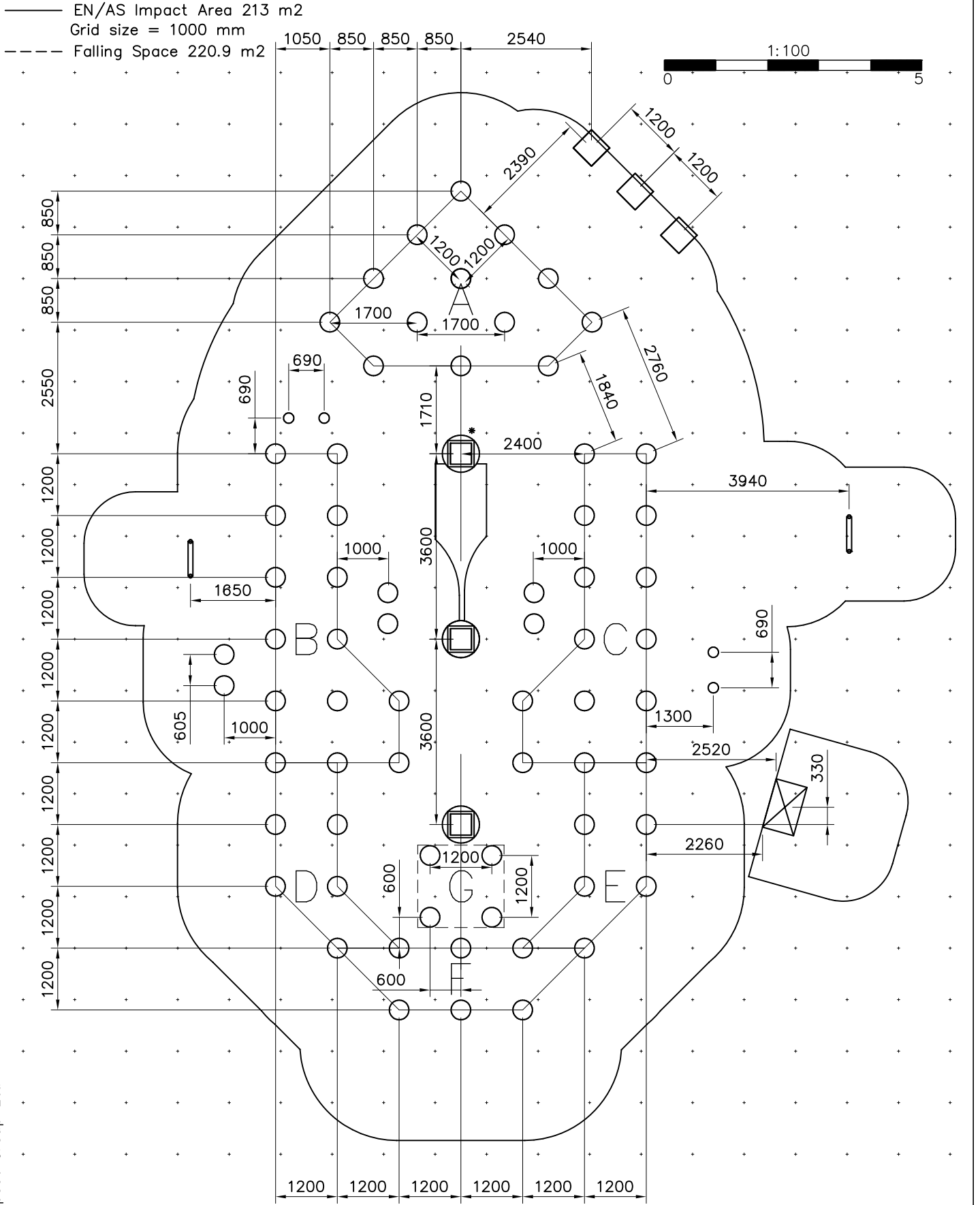

 * START POINT (CENTER TO CENTER)

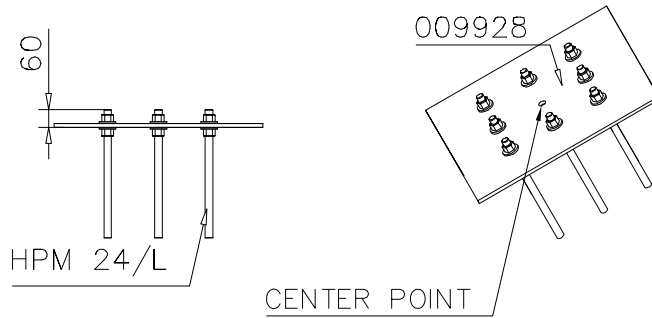

CONCRETE PLATE SOLUTION

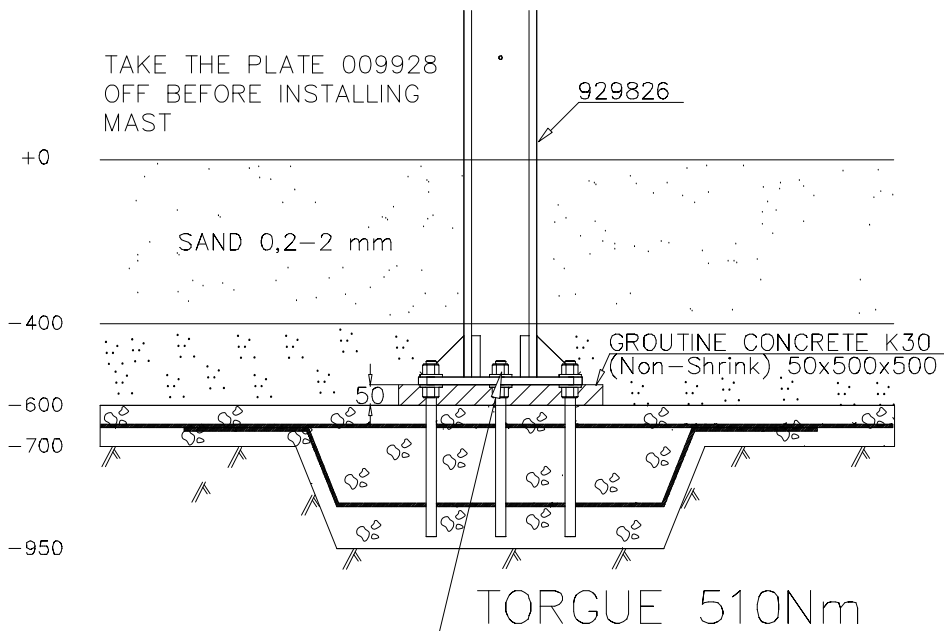
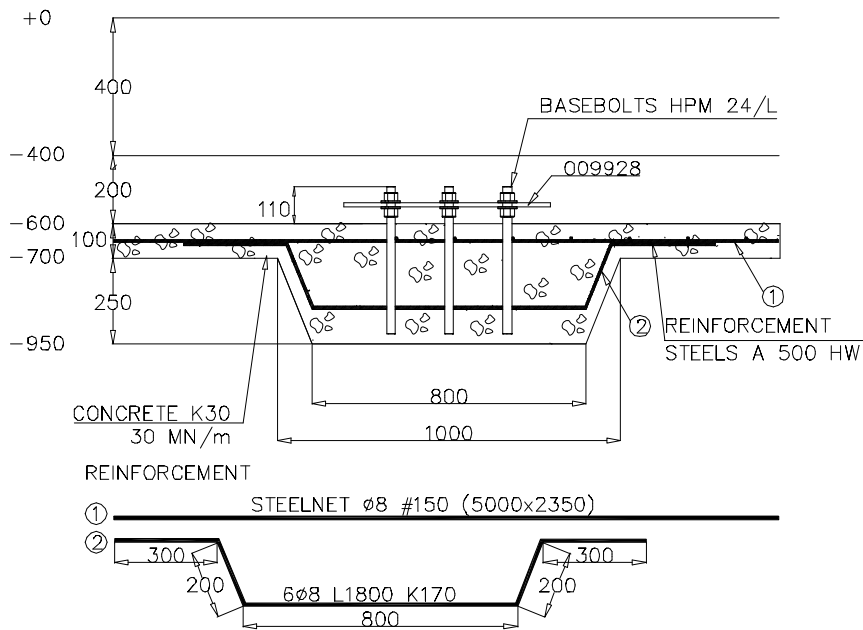

OPTION CONCRETE BLOCK SOLUTION

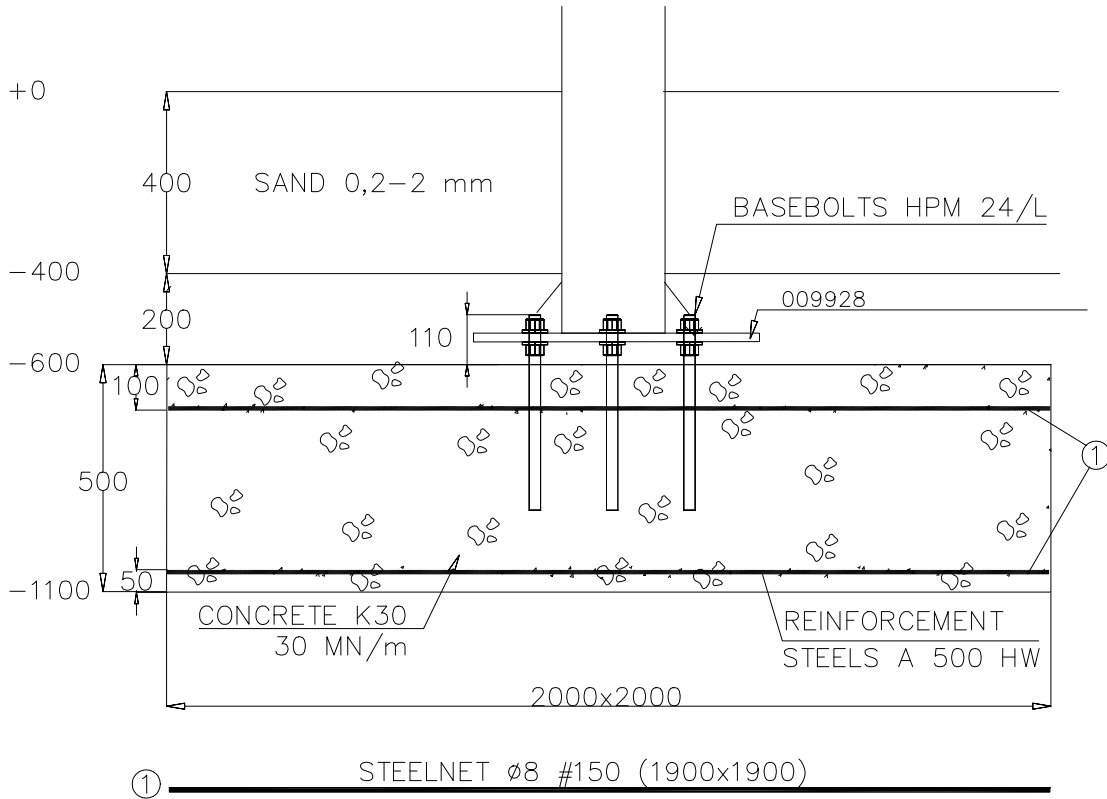

TAKE THE PLATE 009928
OFF BEFORE INSTALLING
MAST

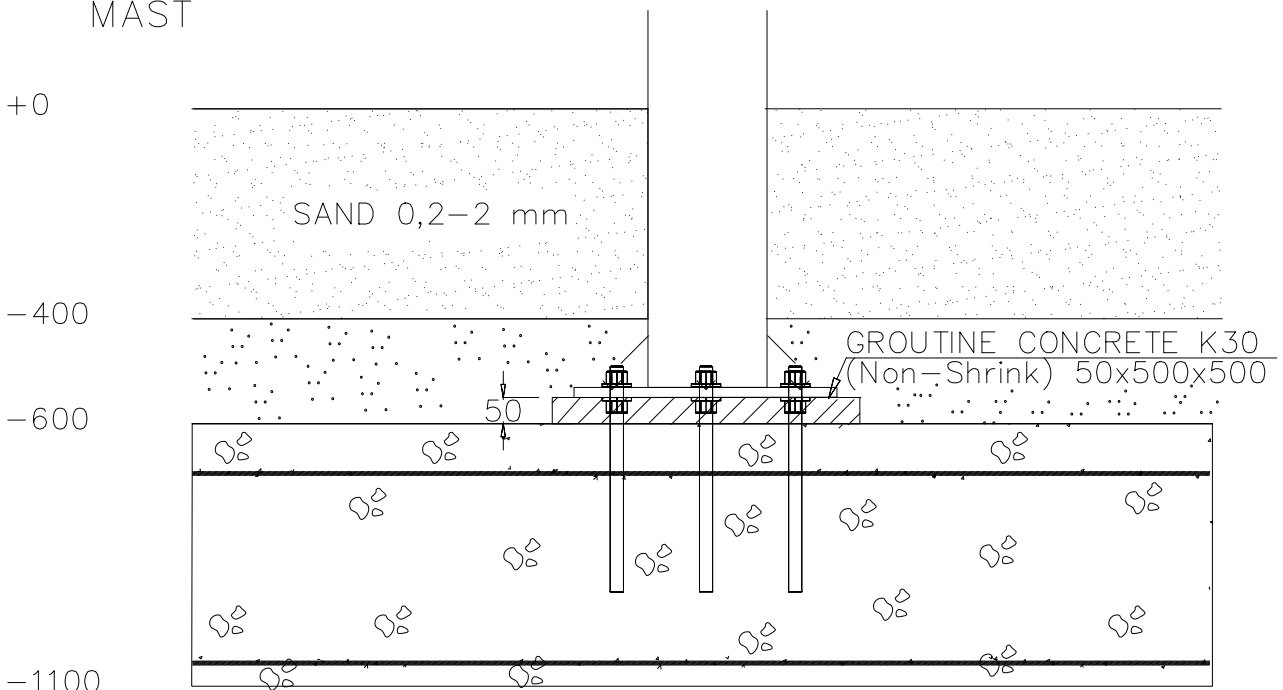

— EN/AS Impact Area 213 m²
 - - - Falling Space 220.9 m²
 Max Falling Height 2760 mm

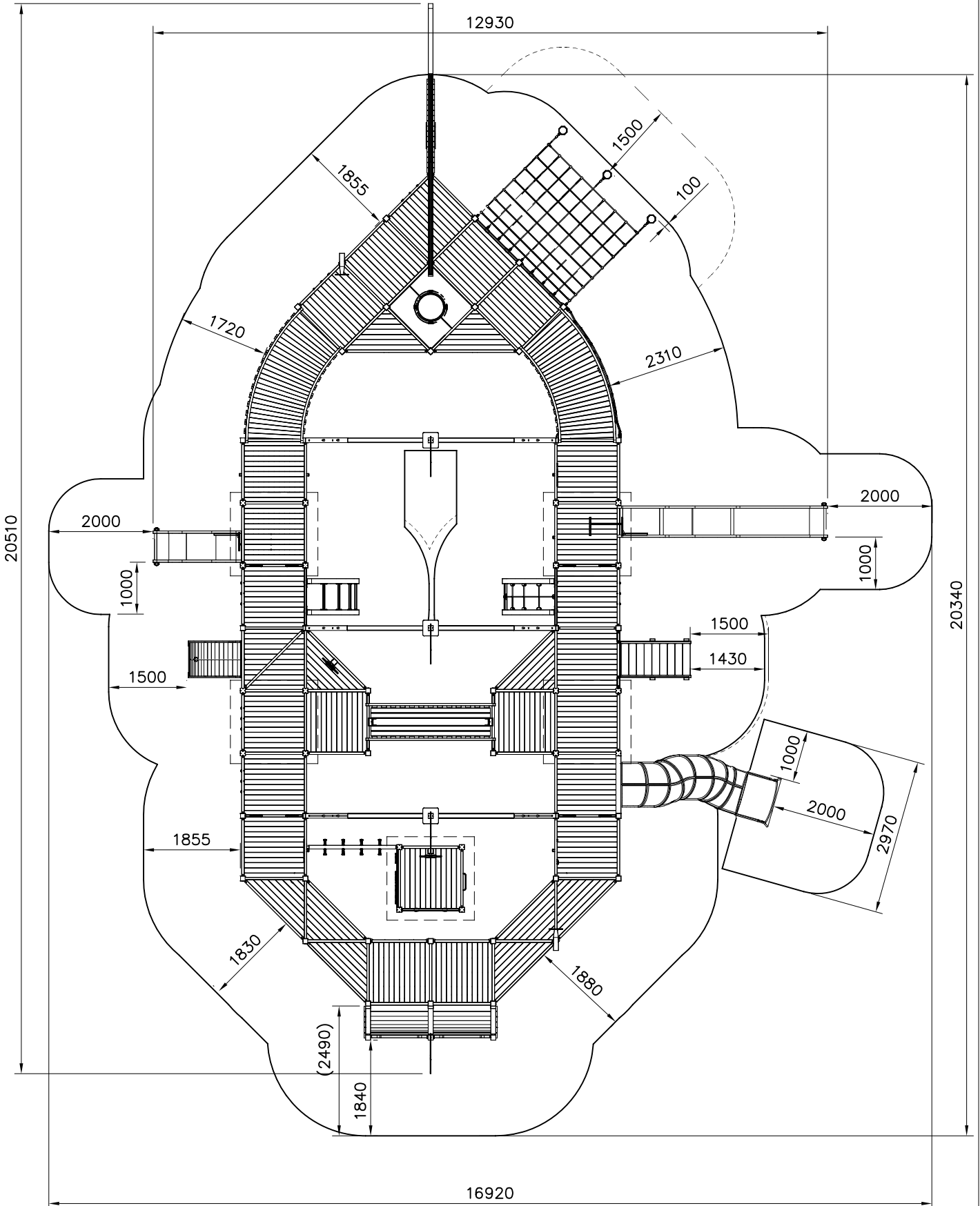
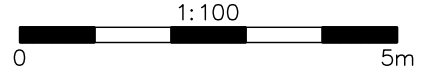

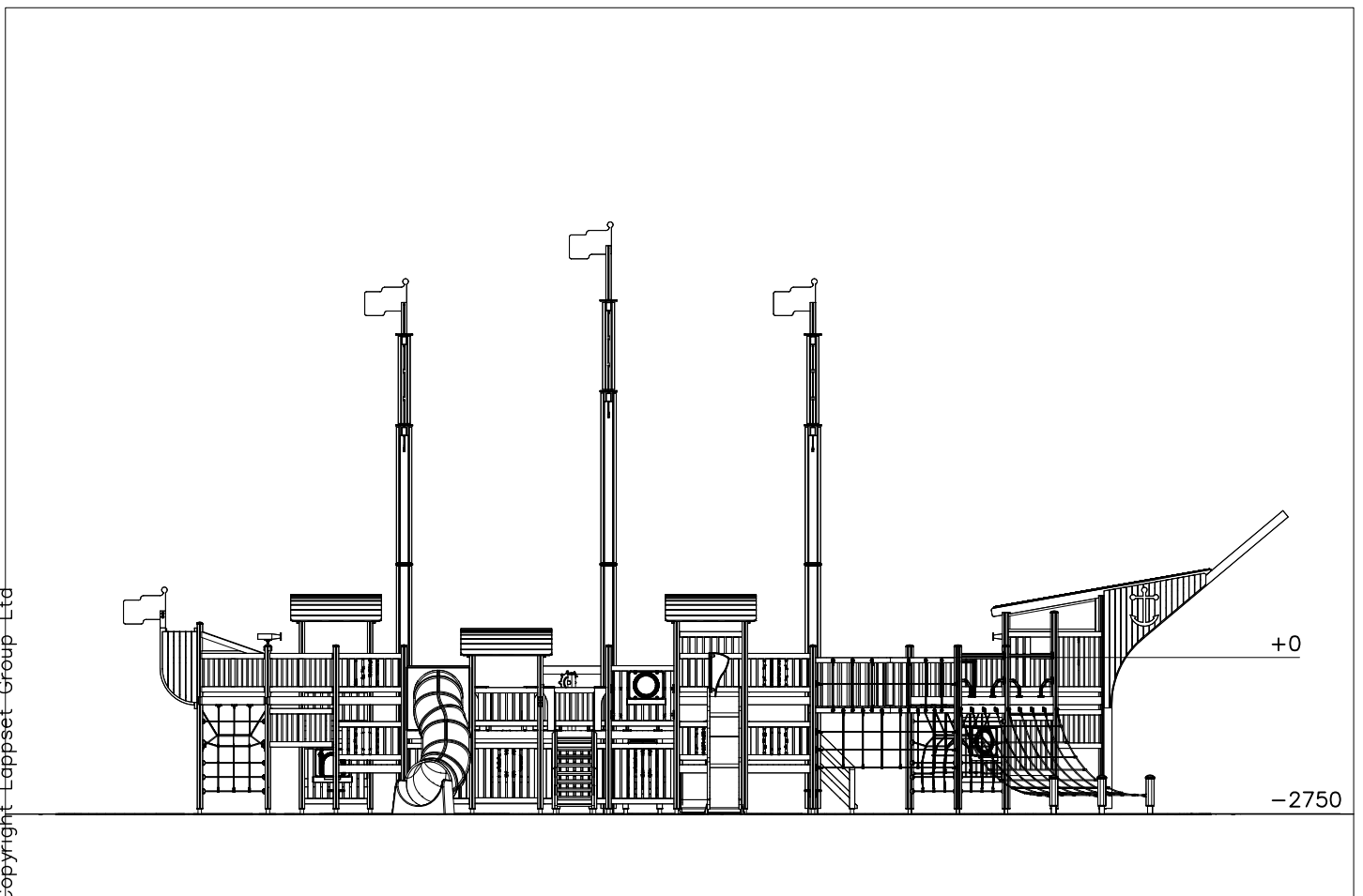
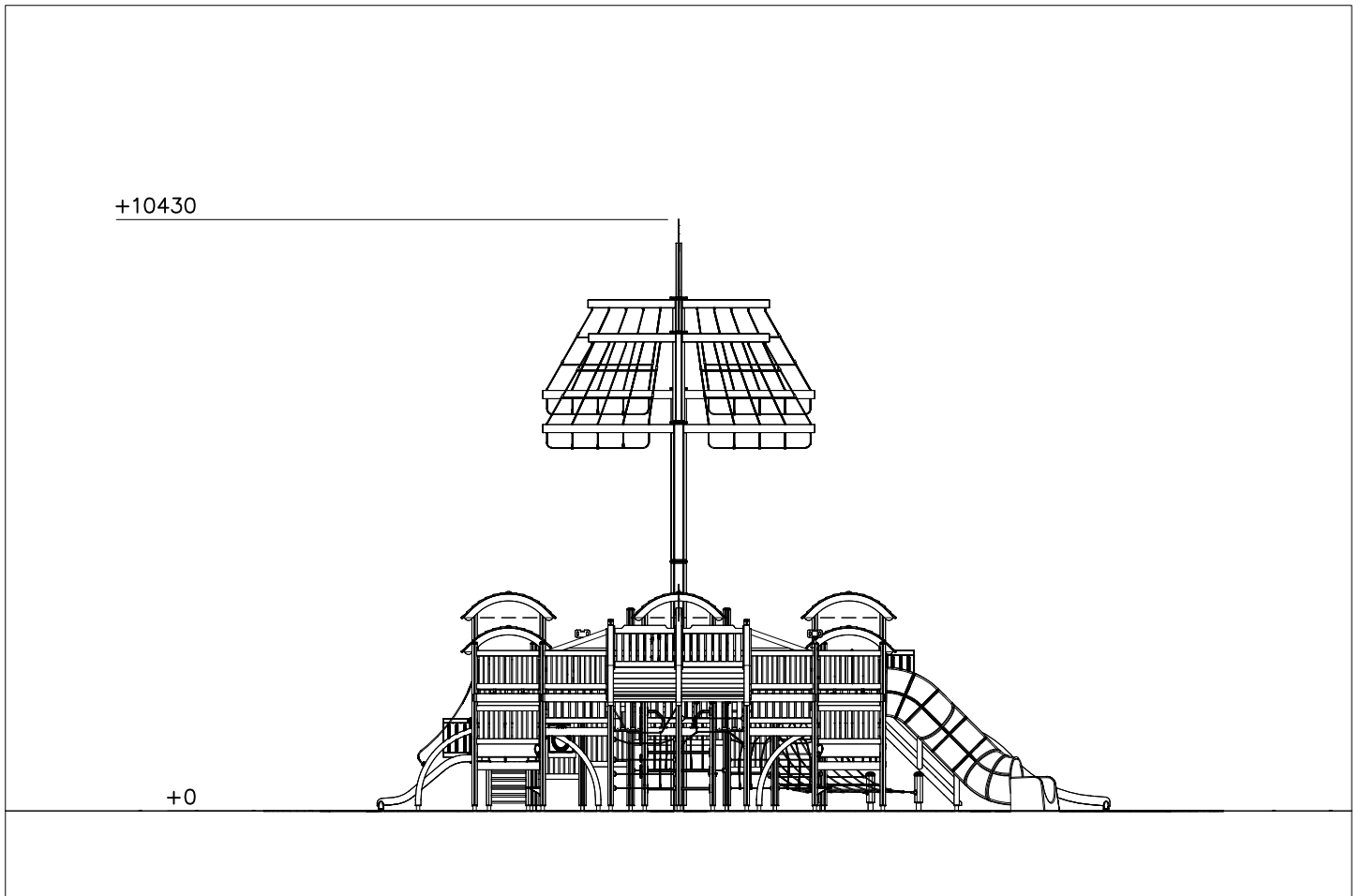

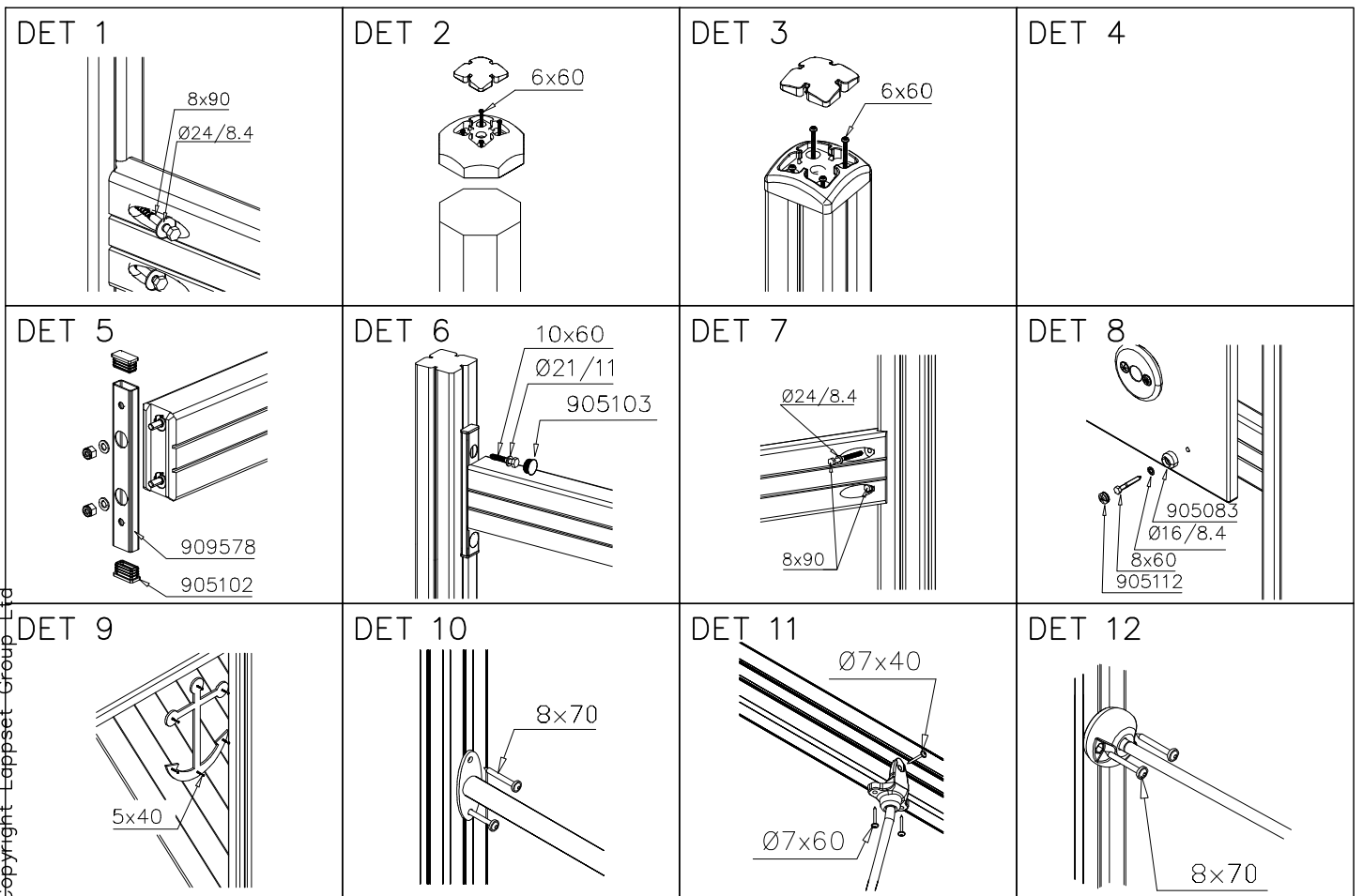
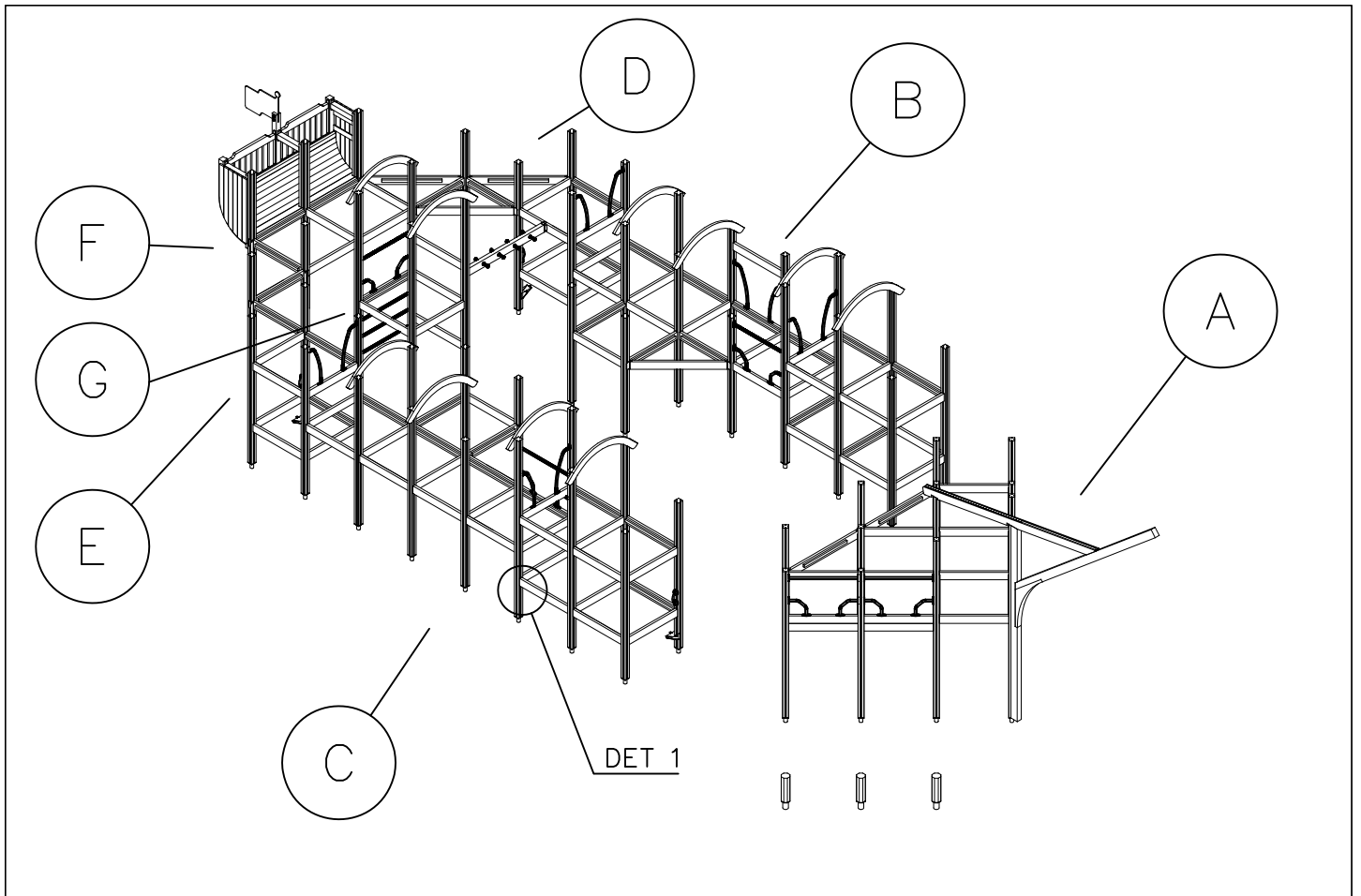

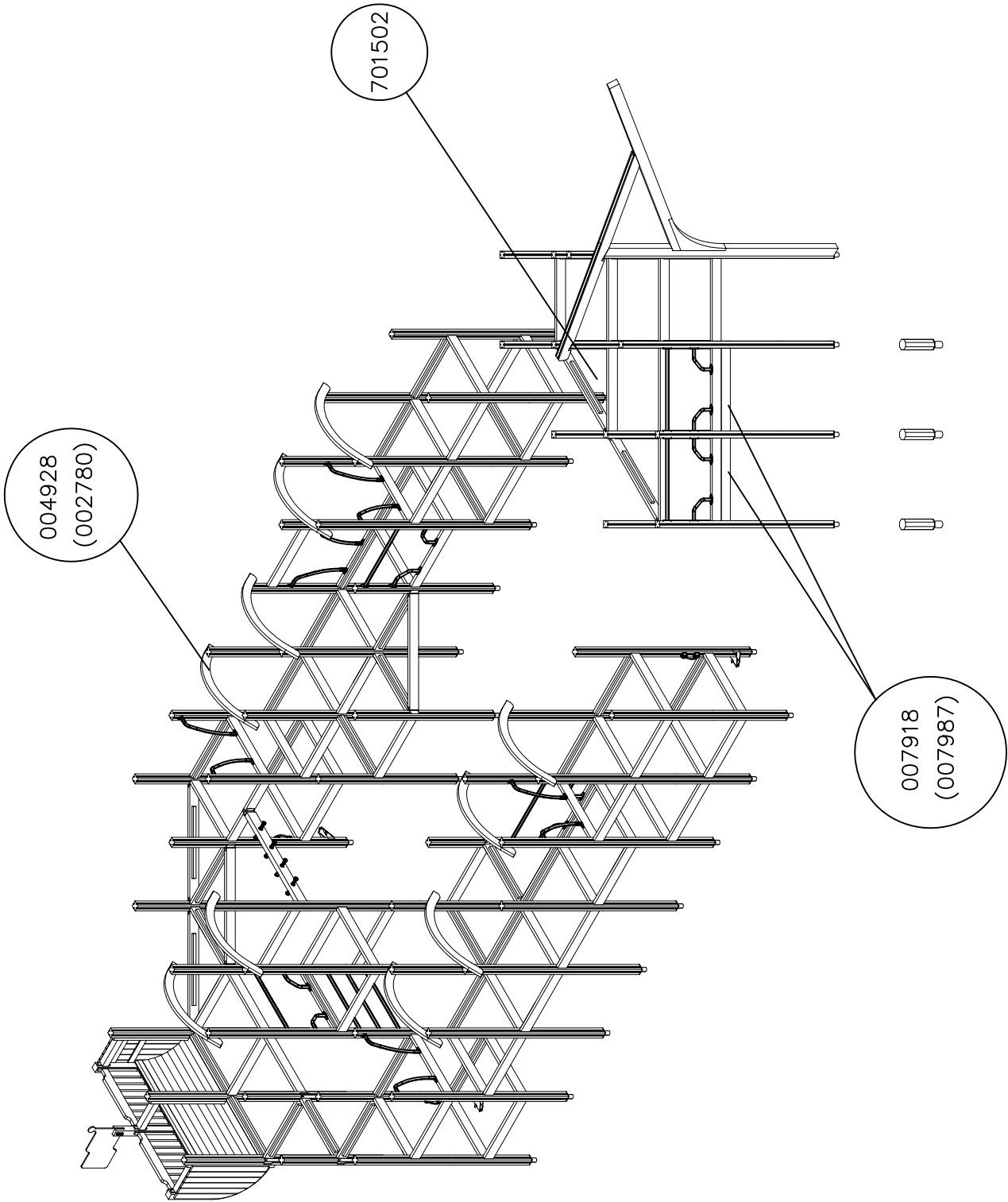

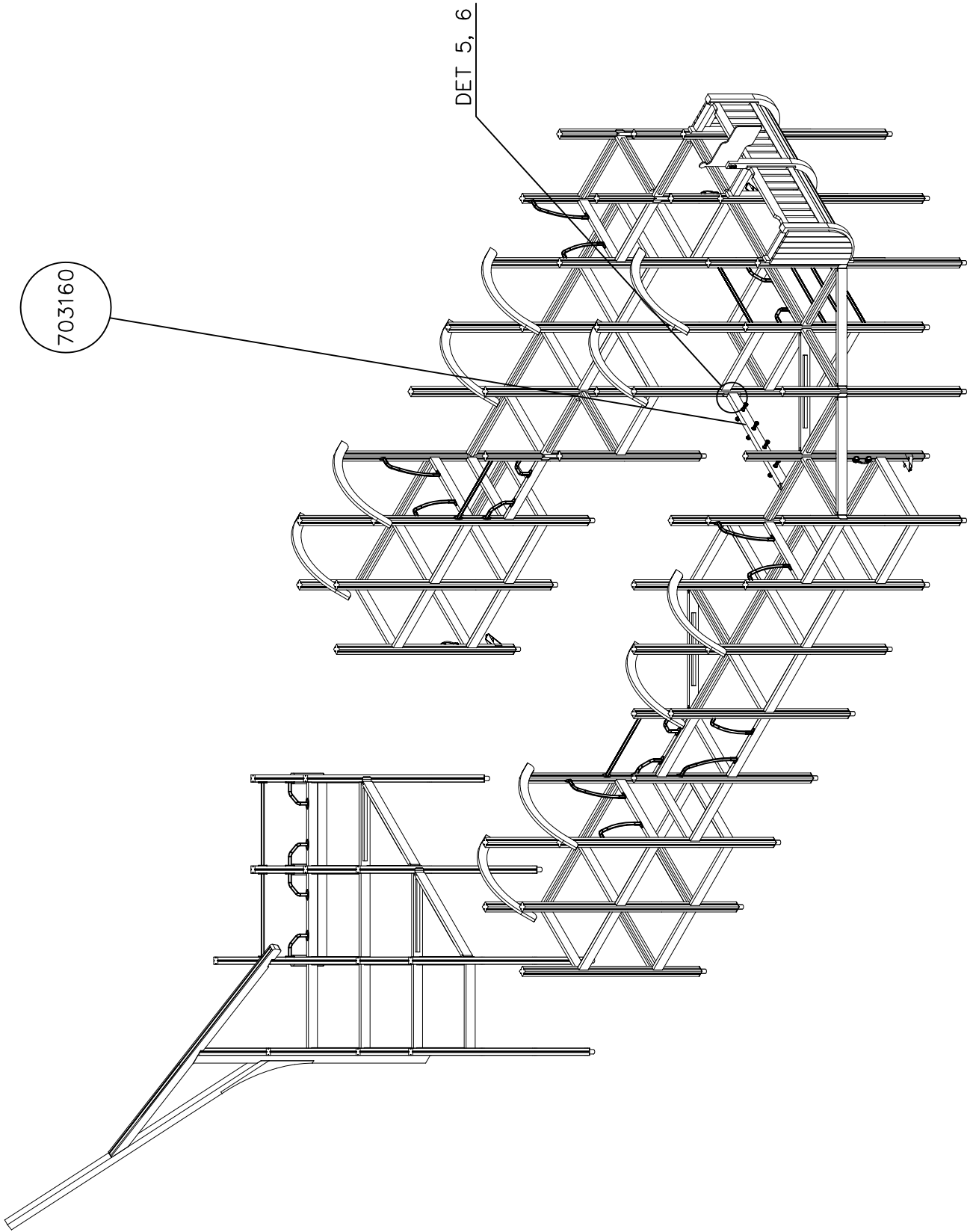

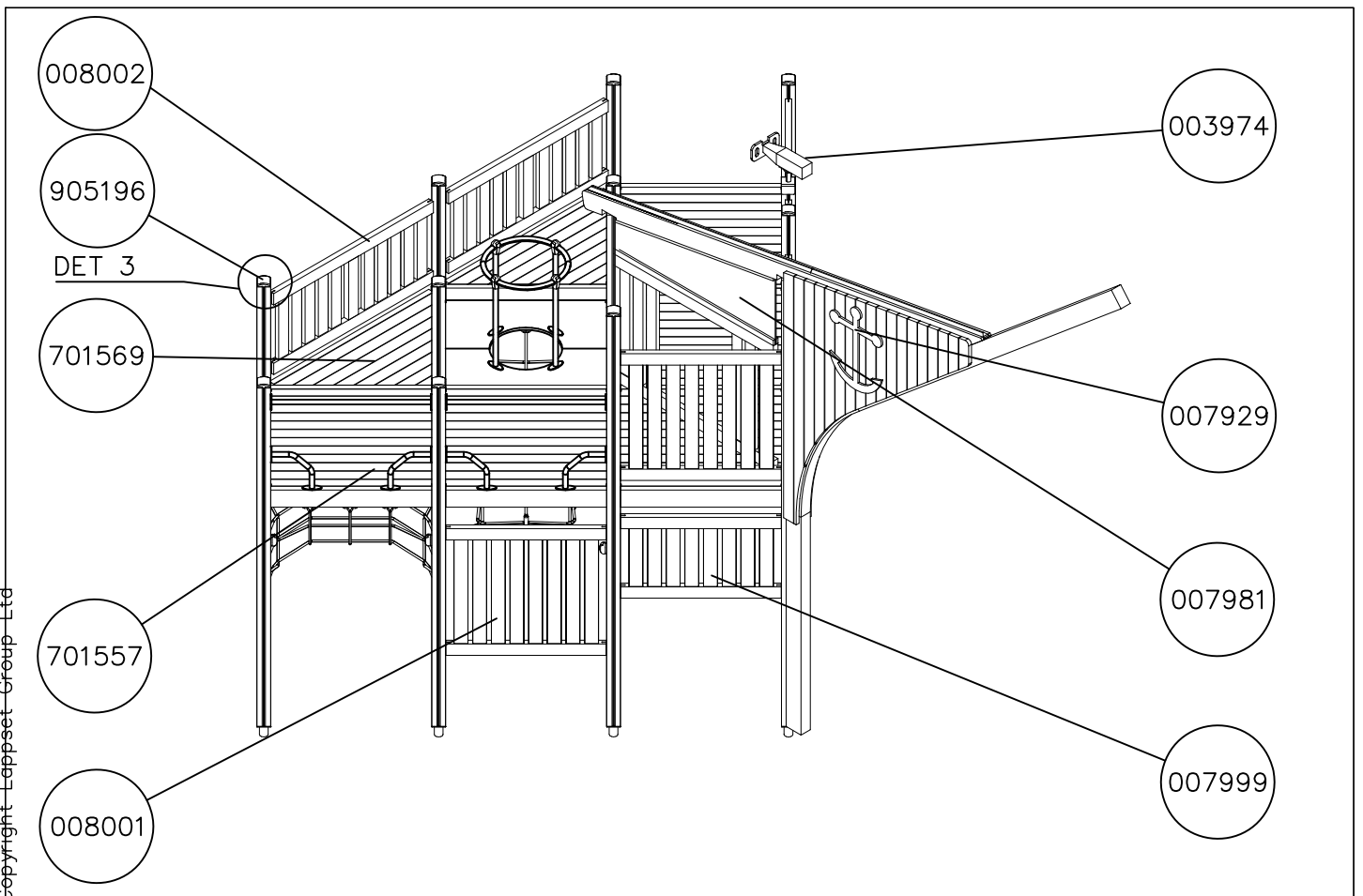
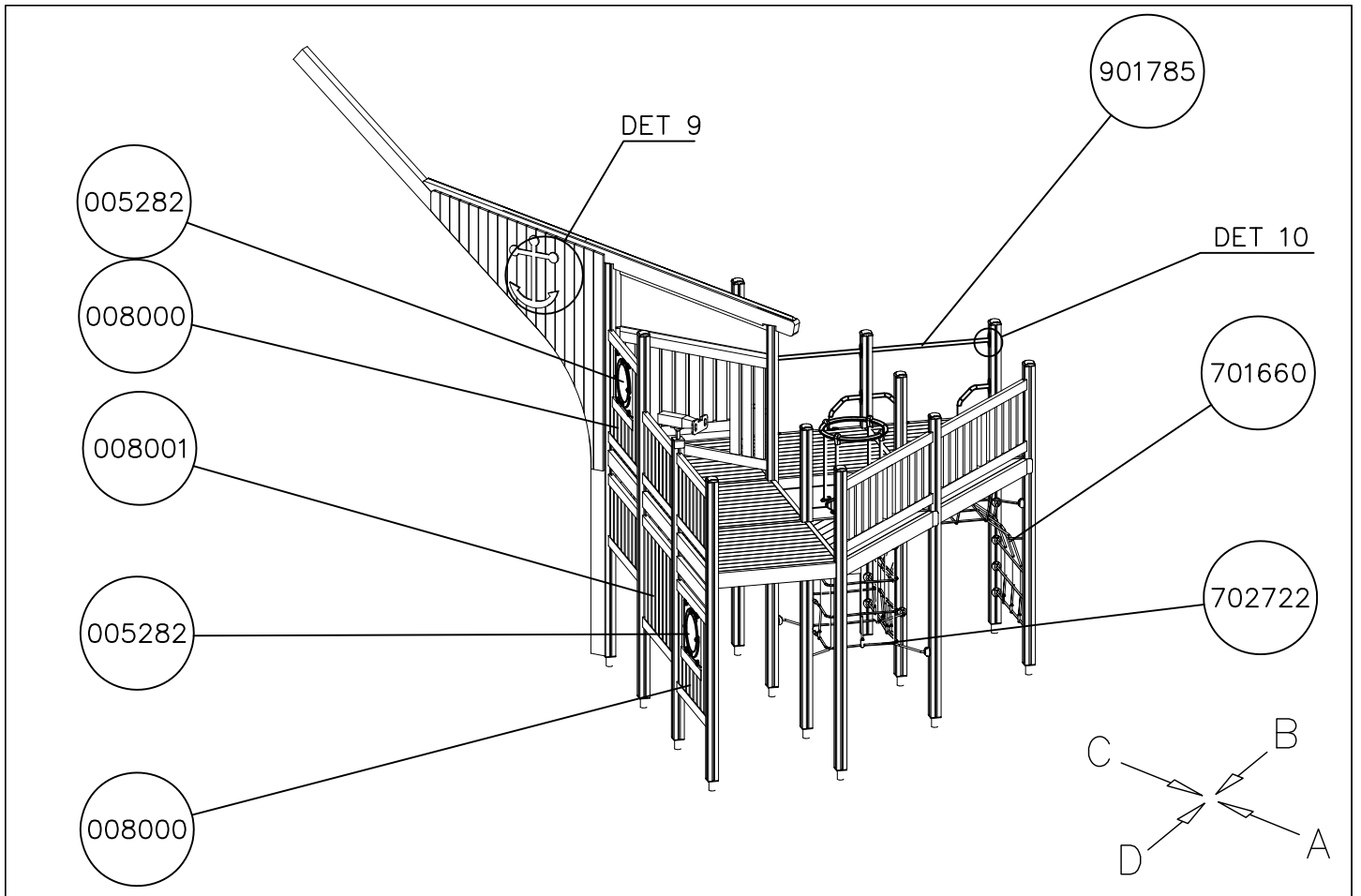

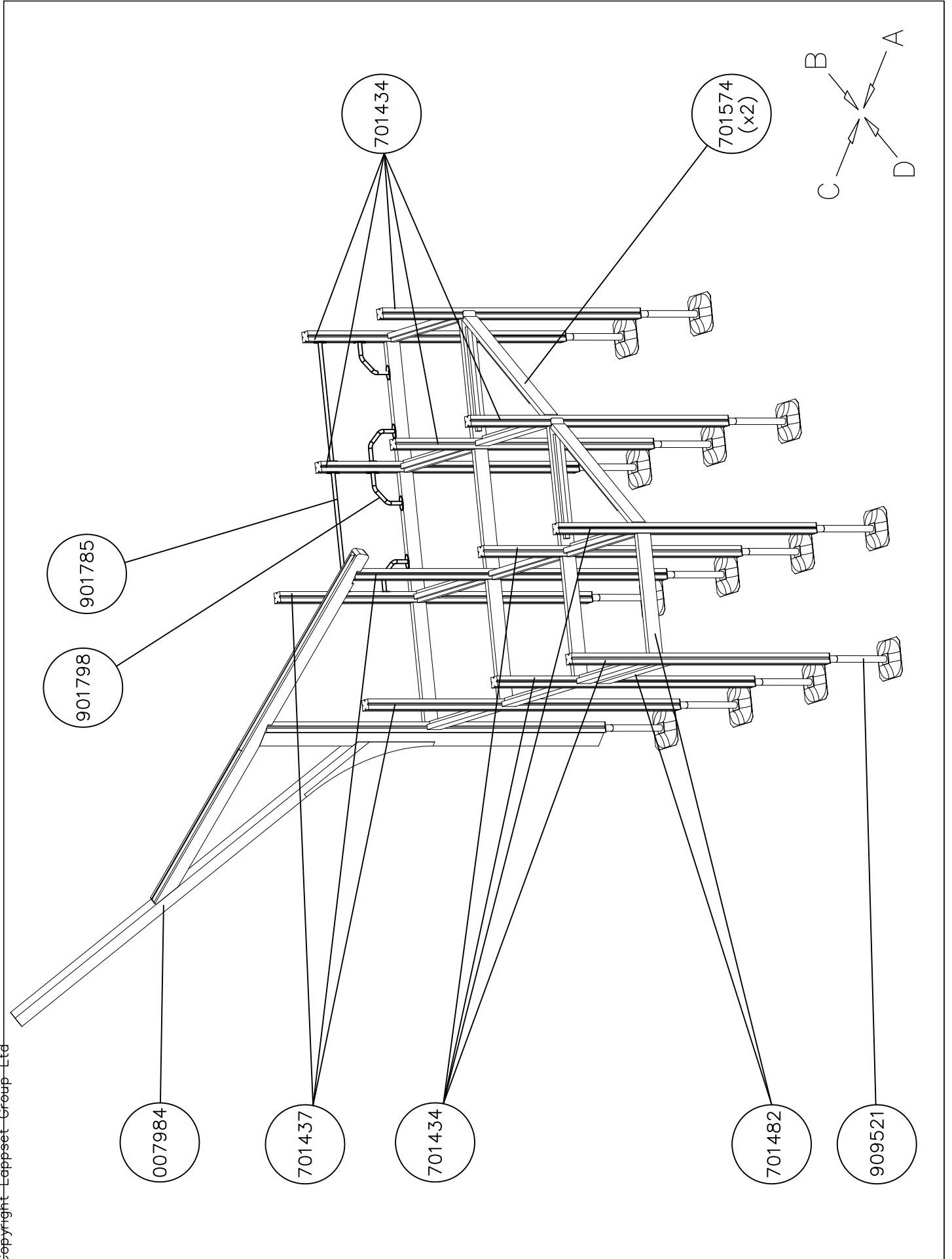

1:75

(A)

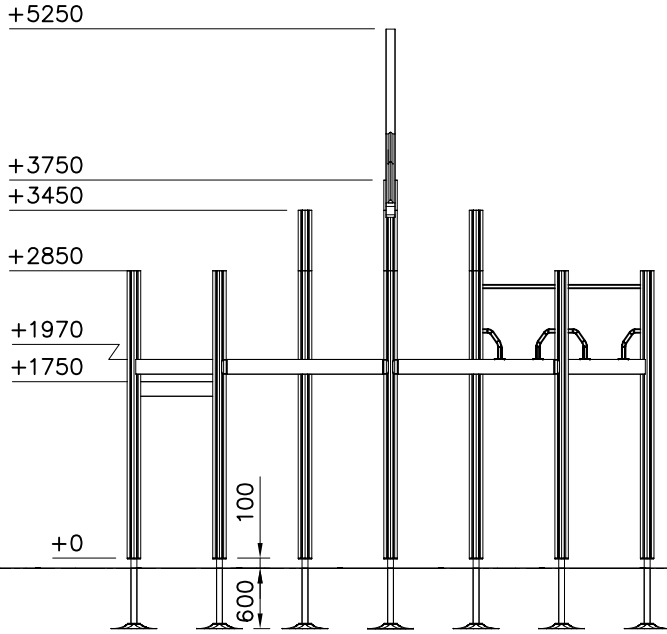

(B)

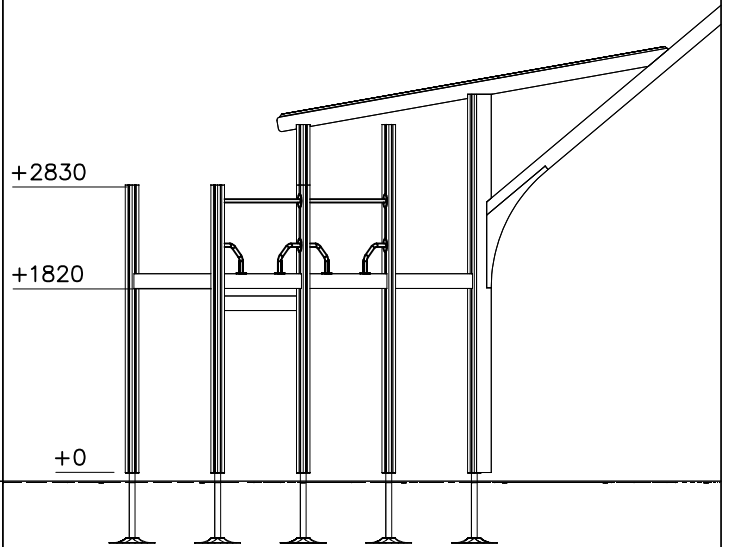

(C)

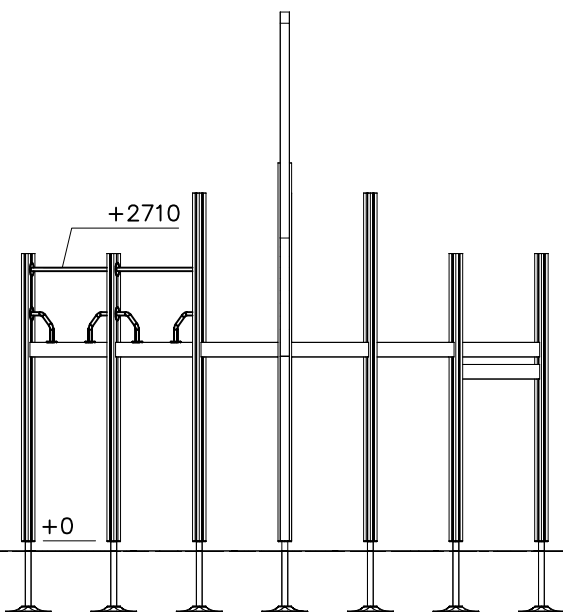

(D)

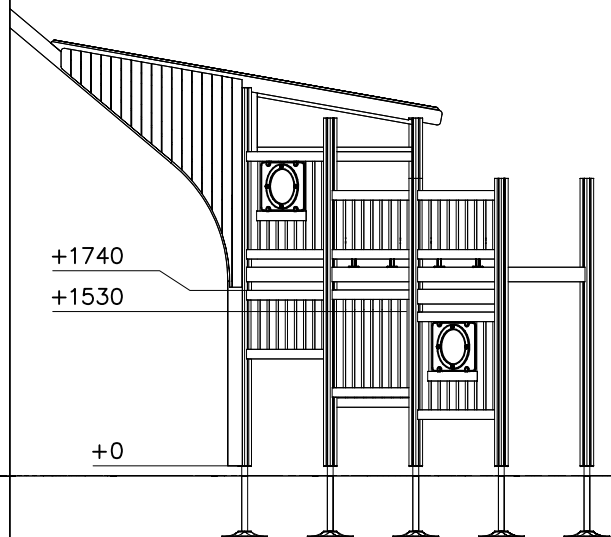

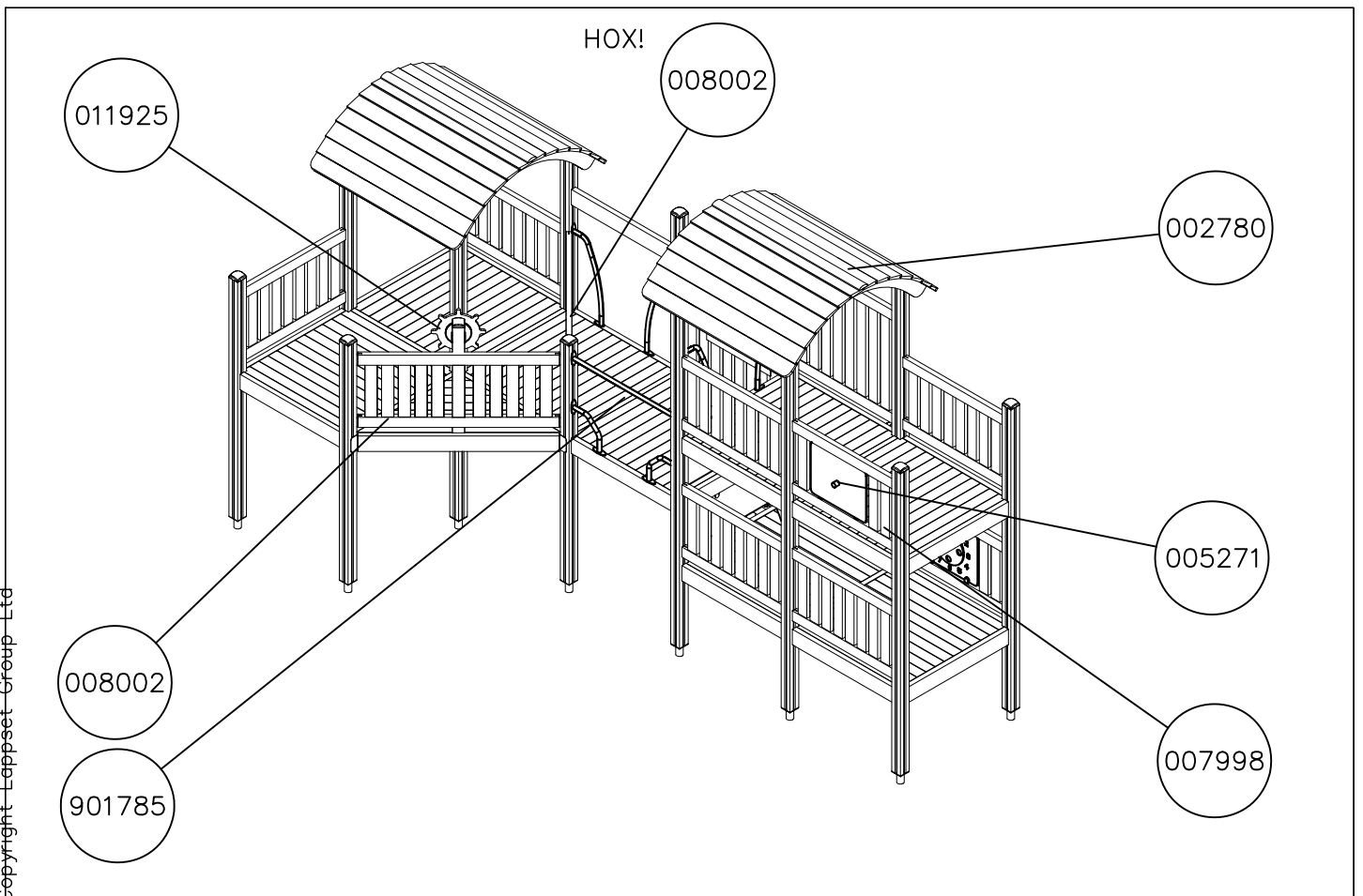
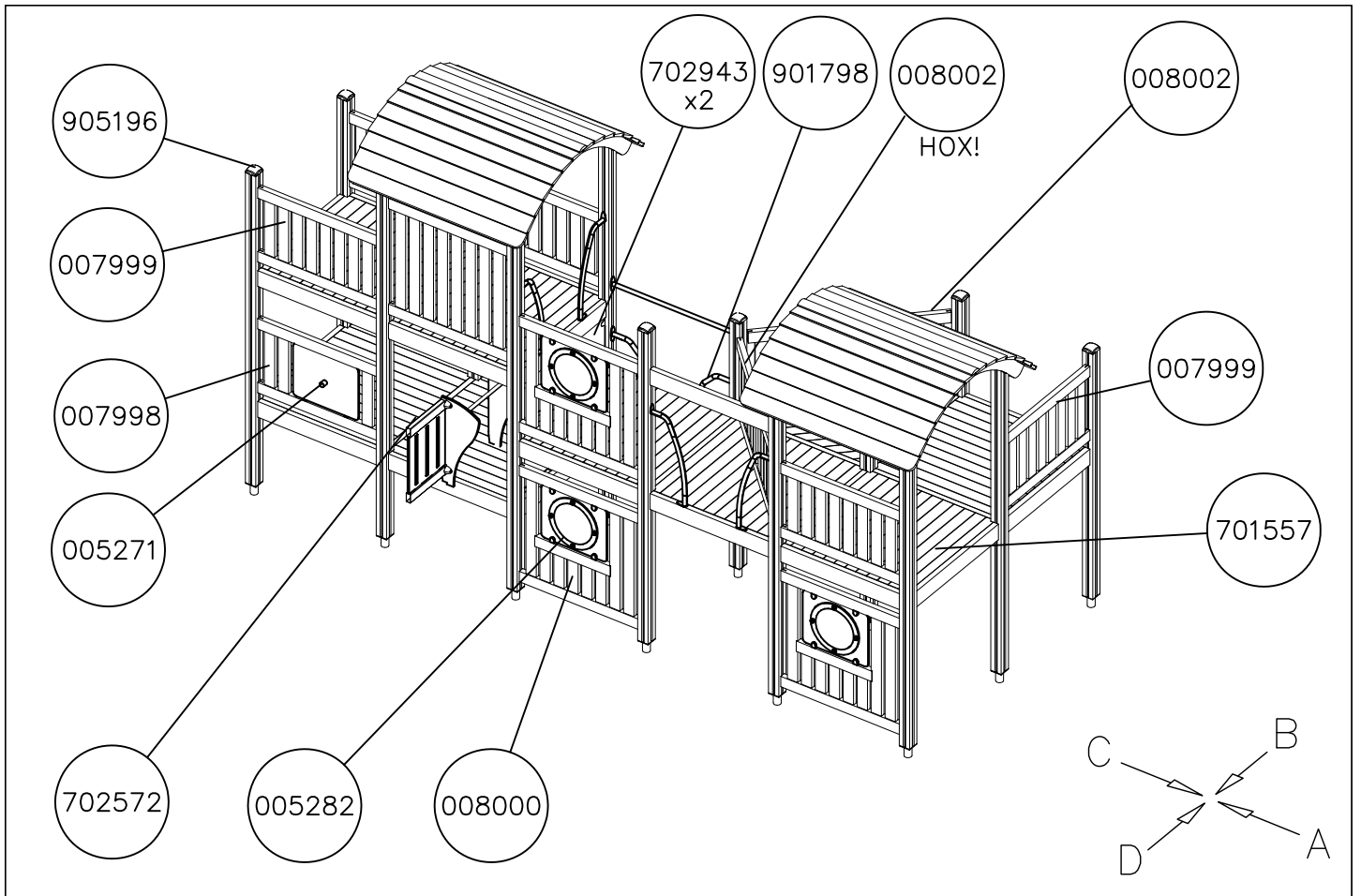

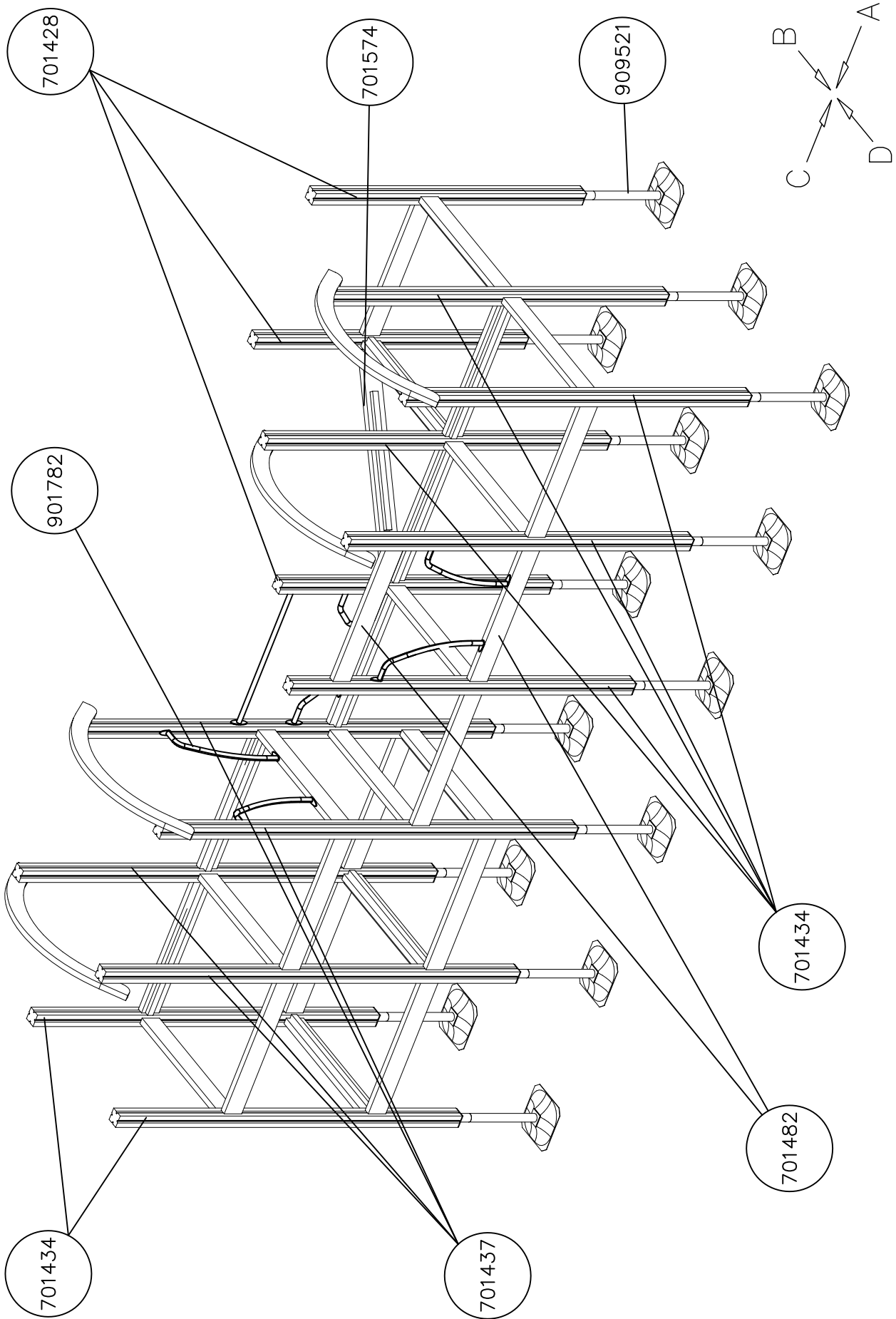

1:75

(A)

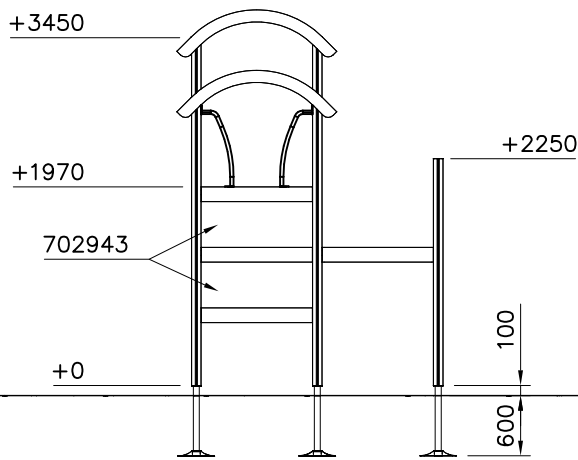

(B)

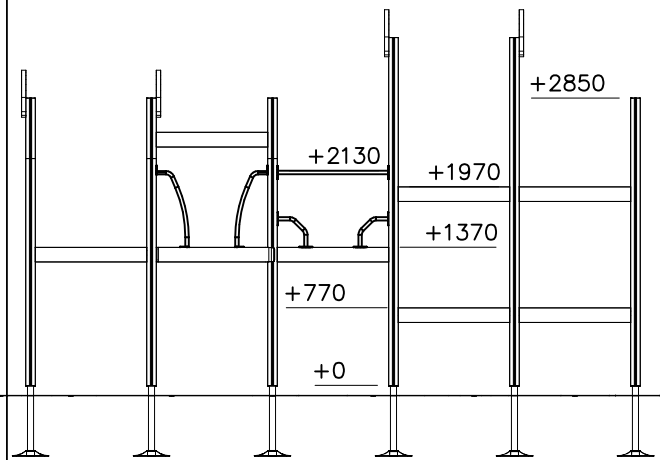

(C)

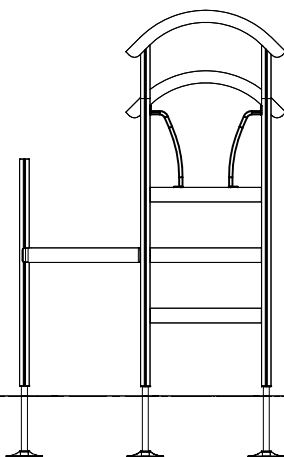

(D)

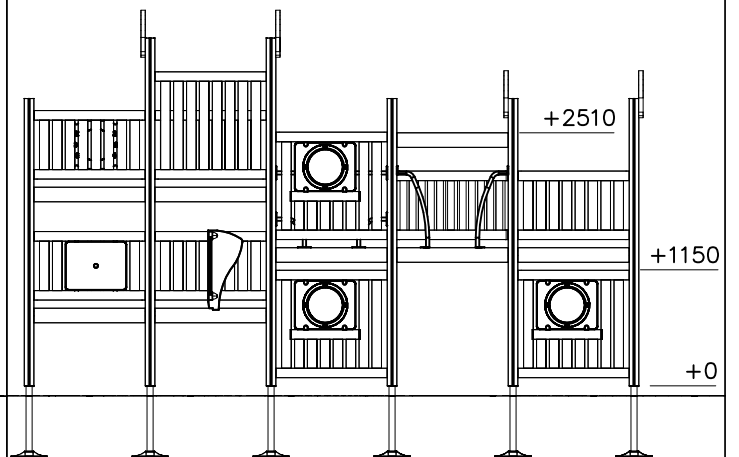

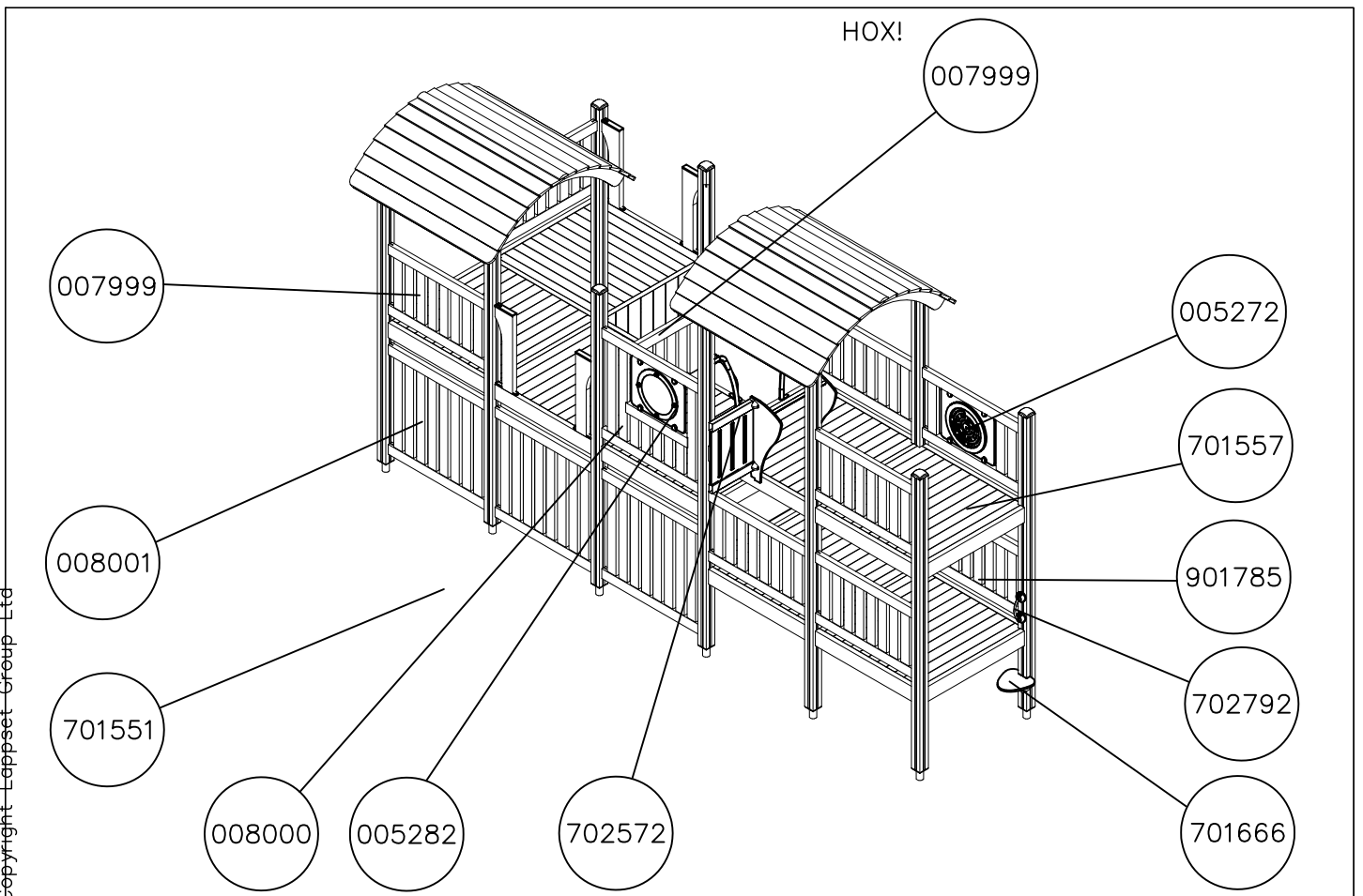
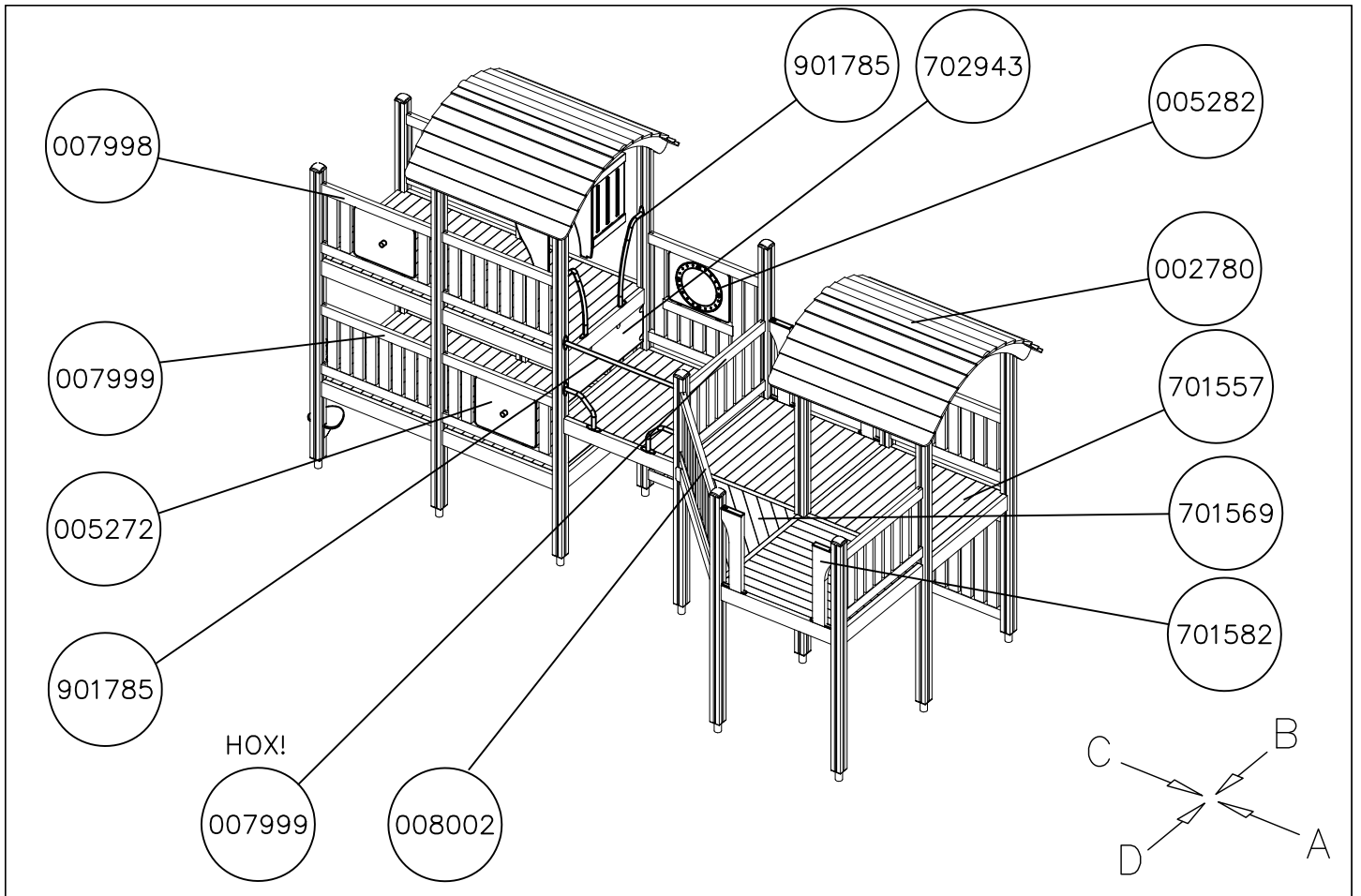

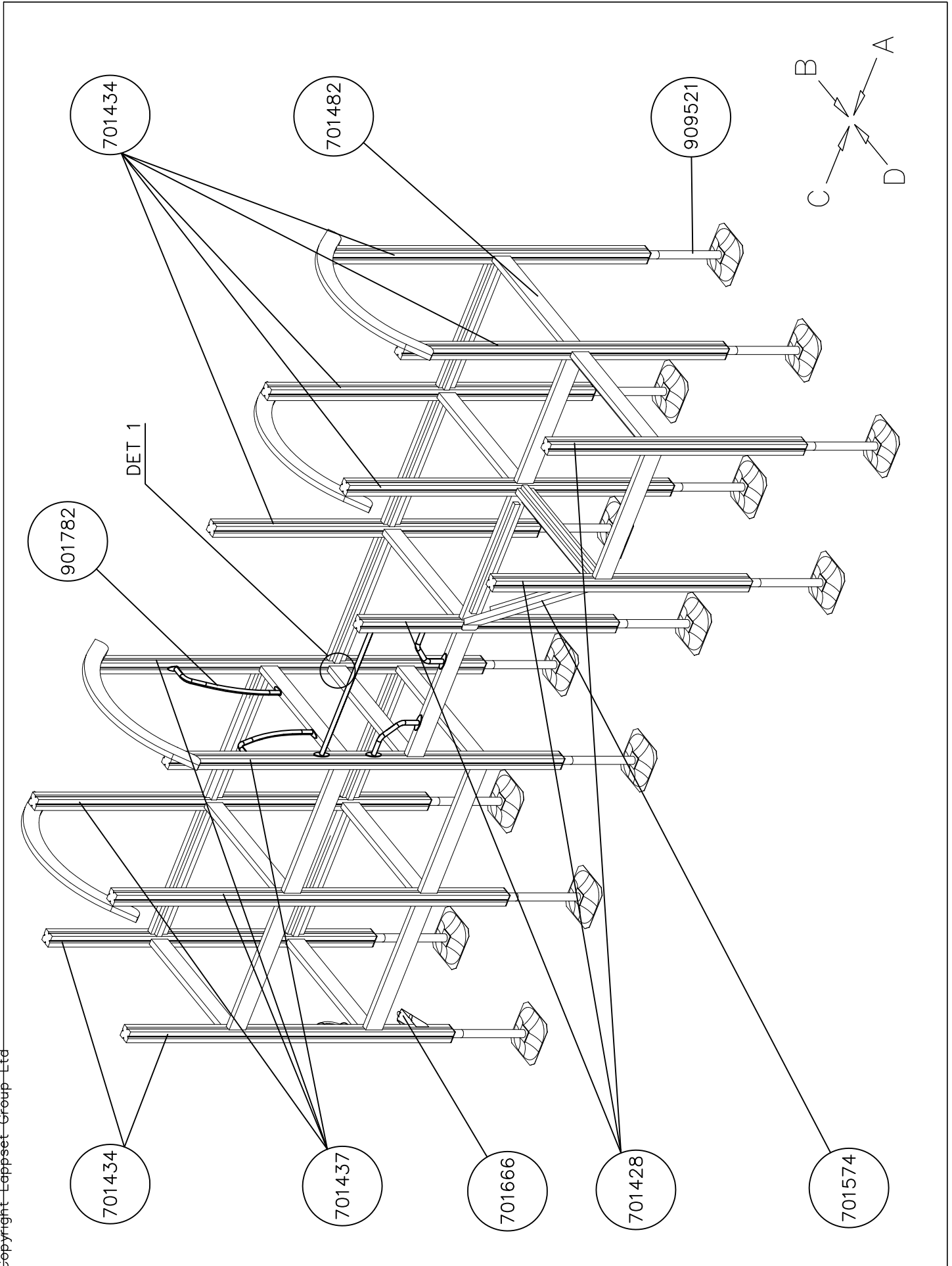

1:75

(A)

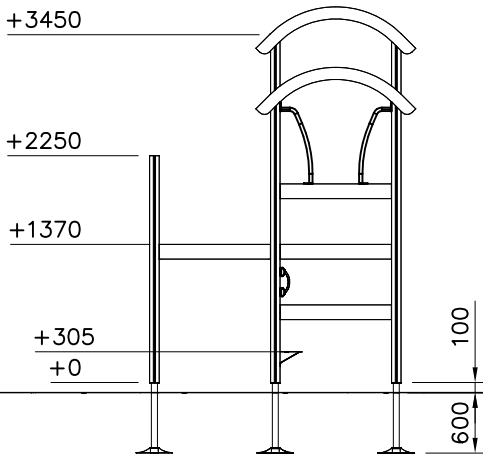

(B)

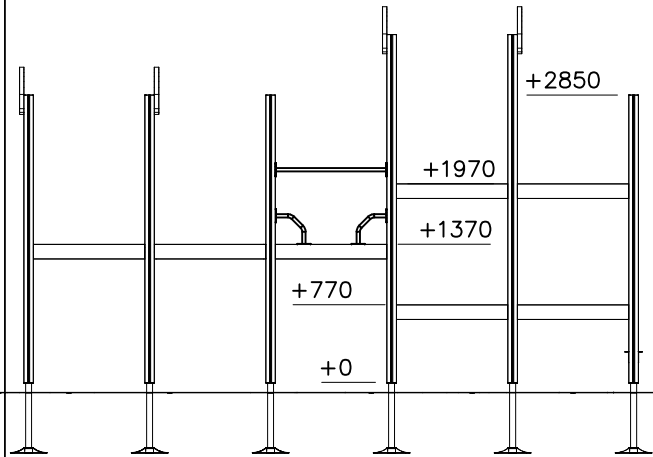

(C)

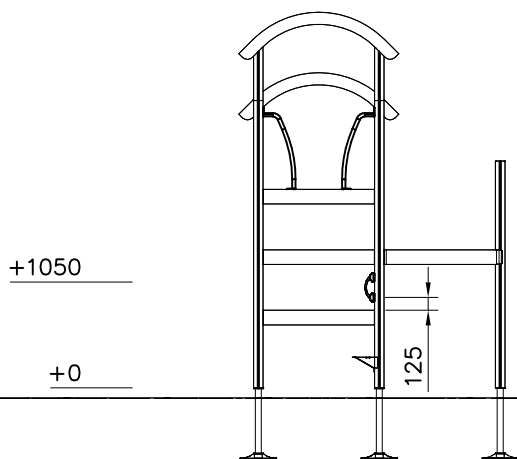

(D)

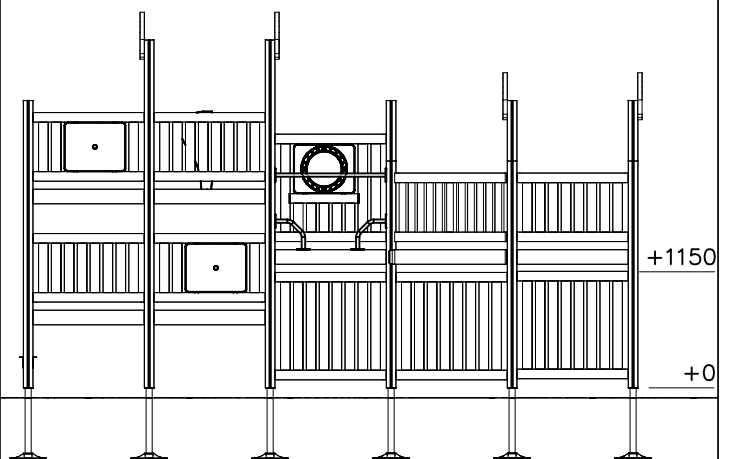

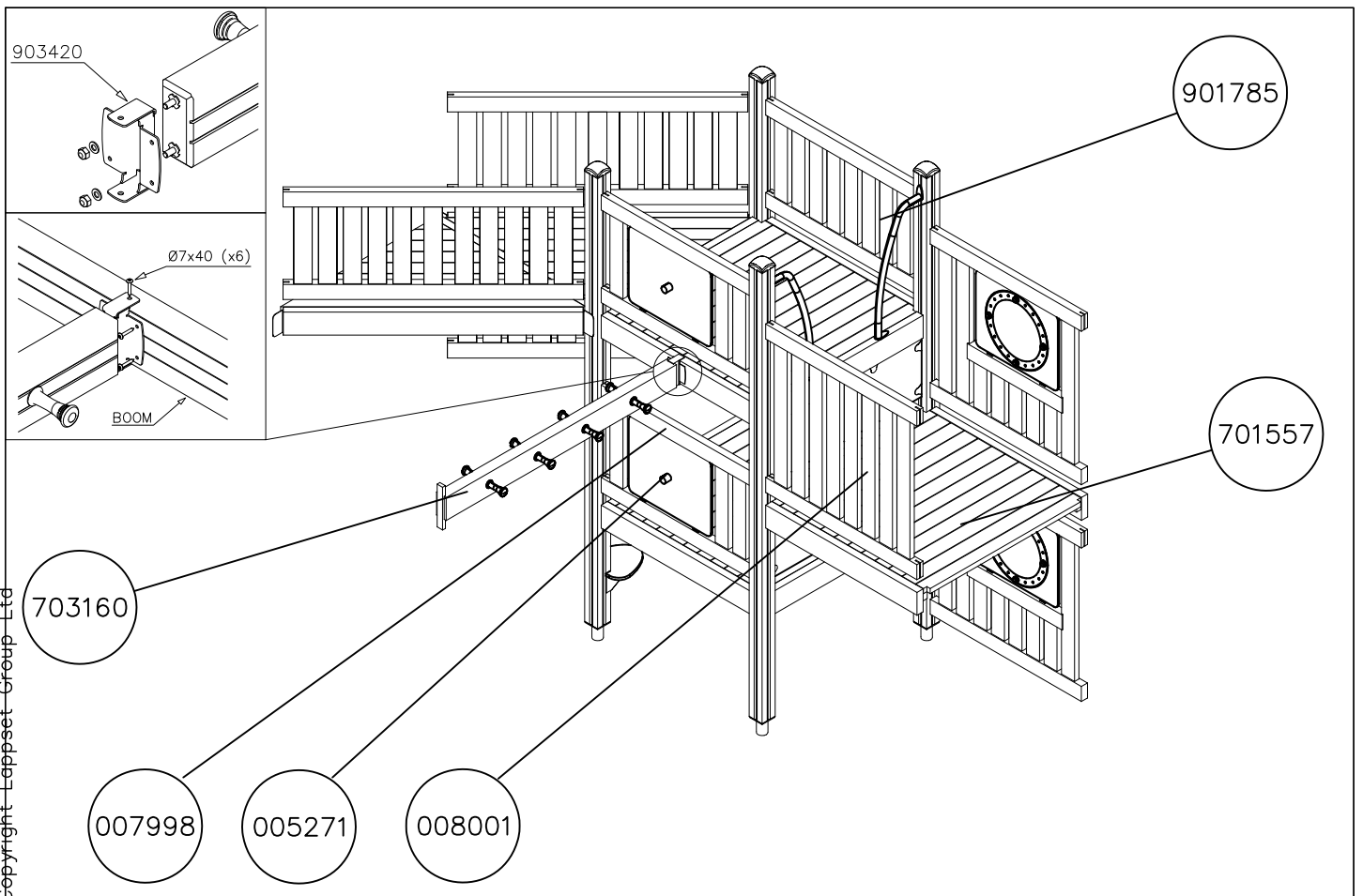
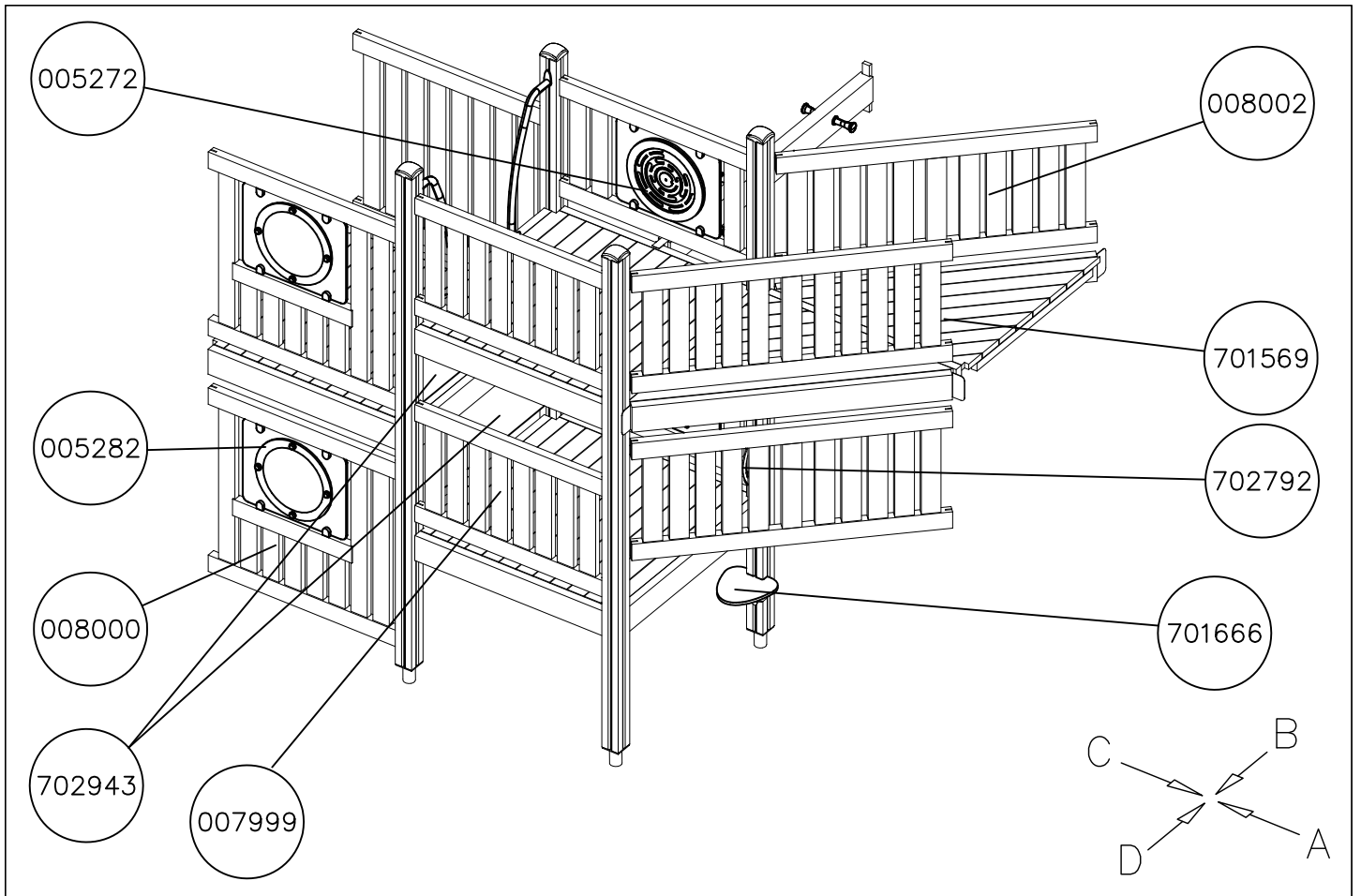

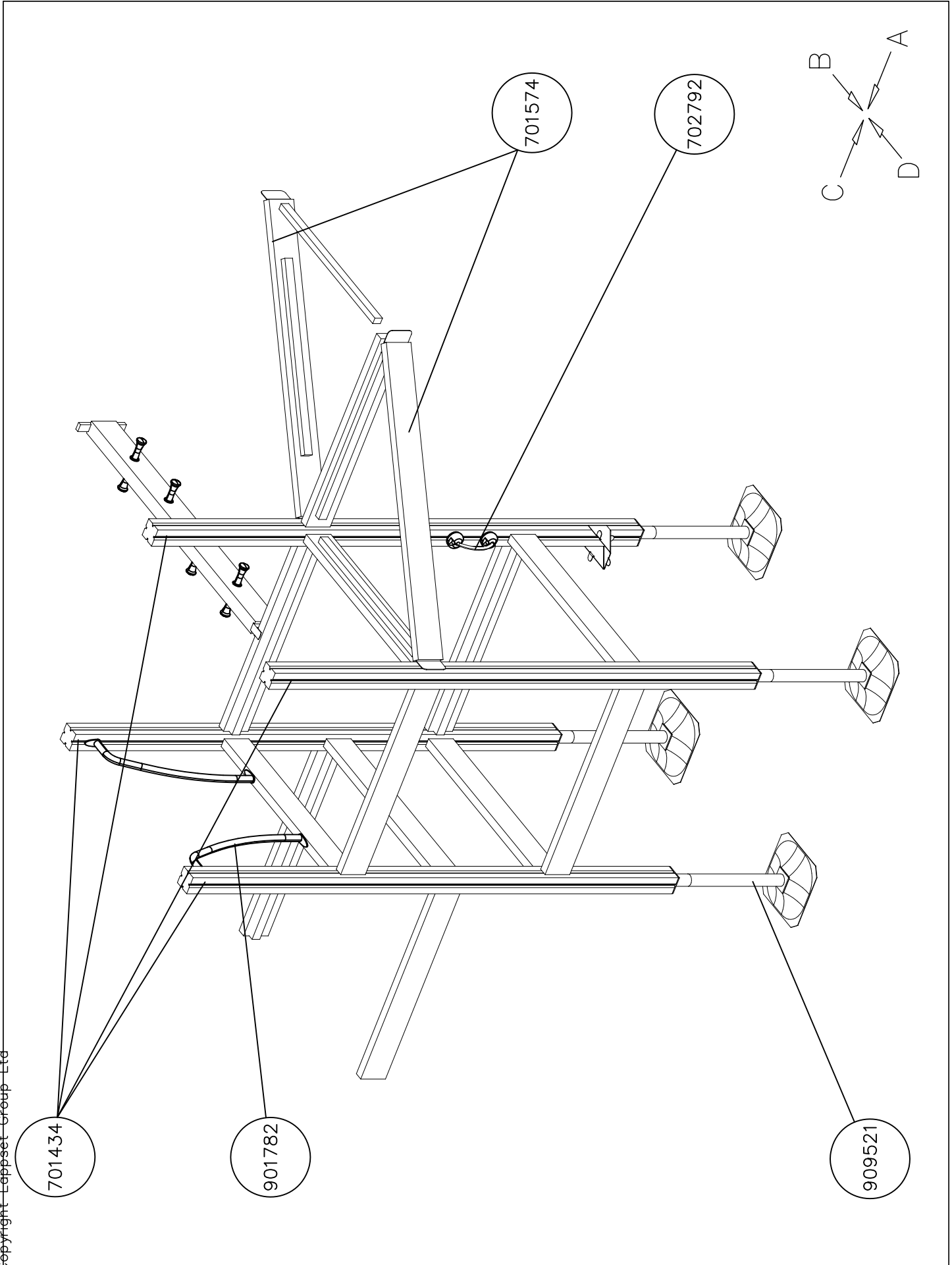

1:50

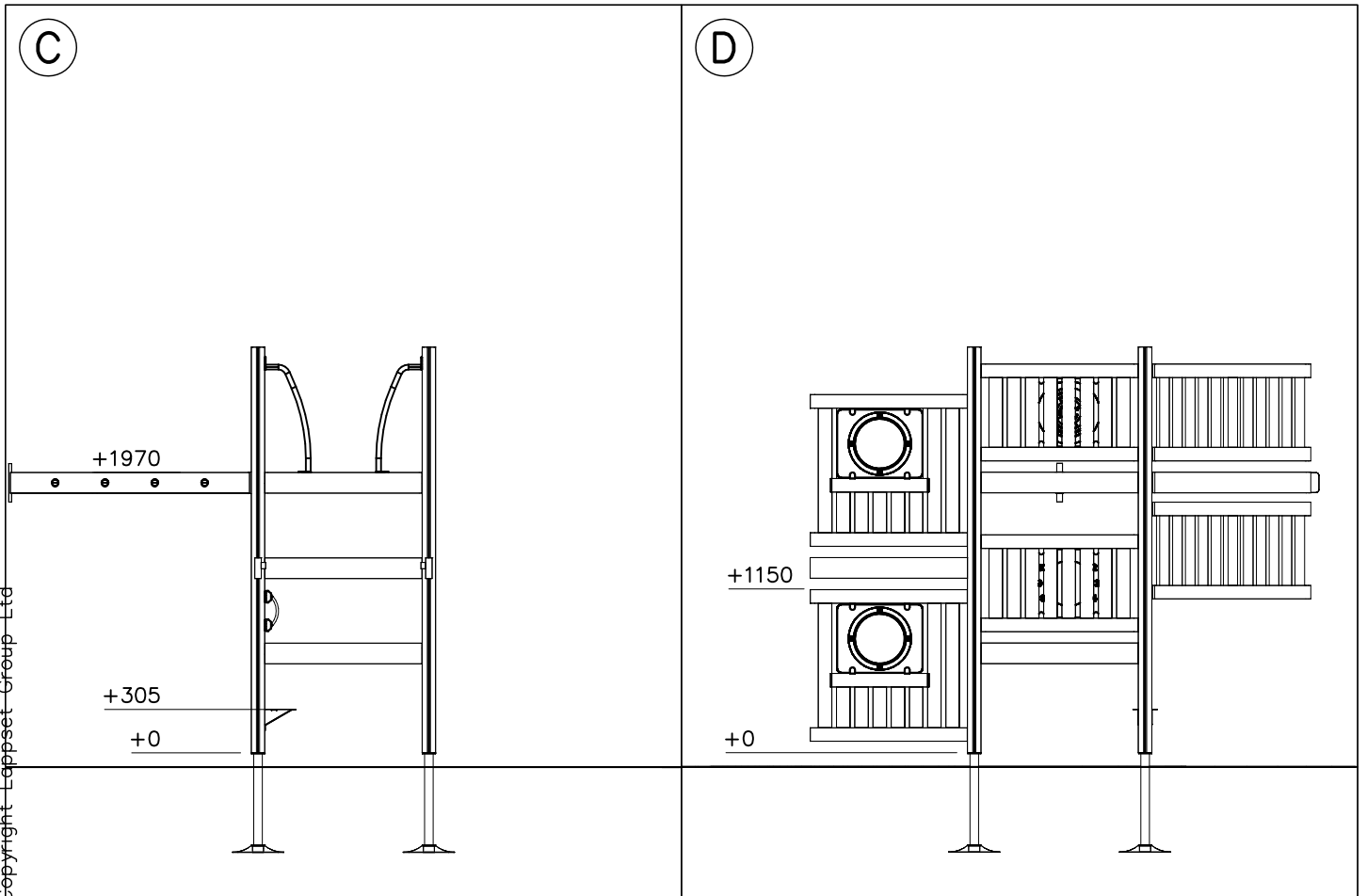
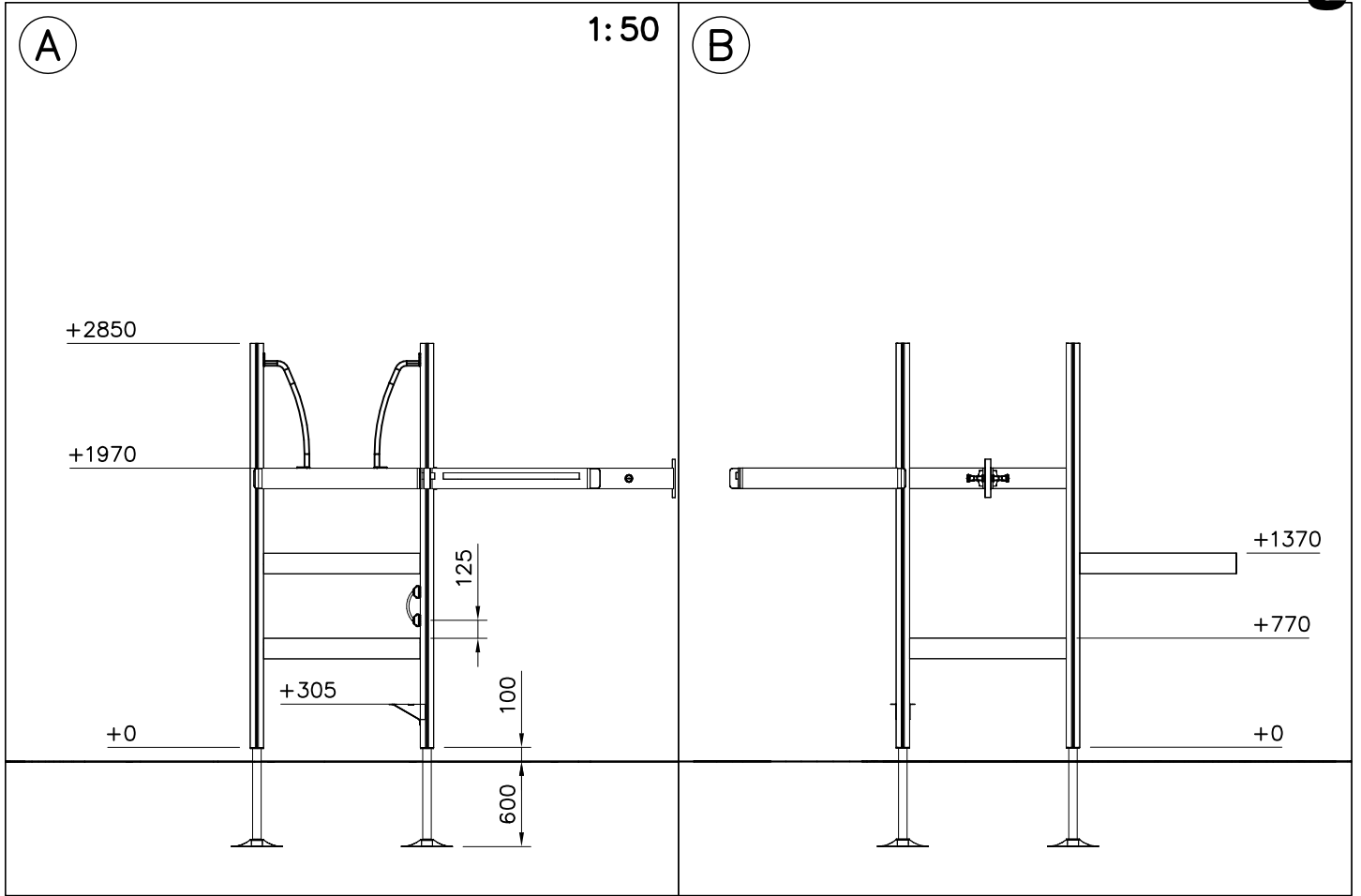

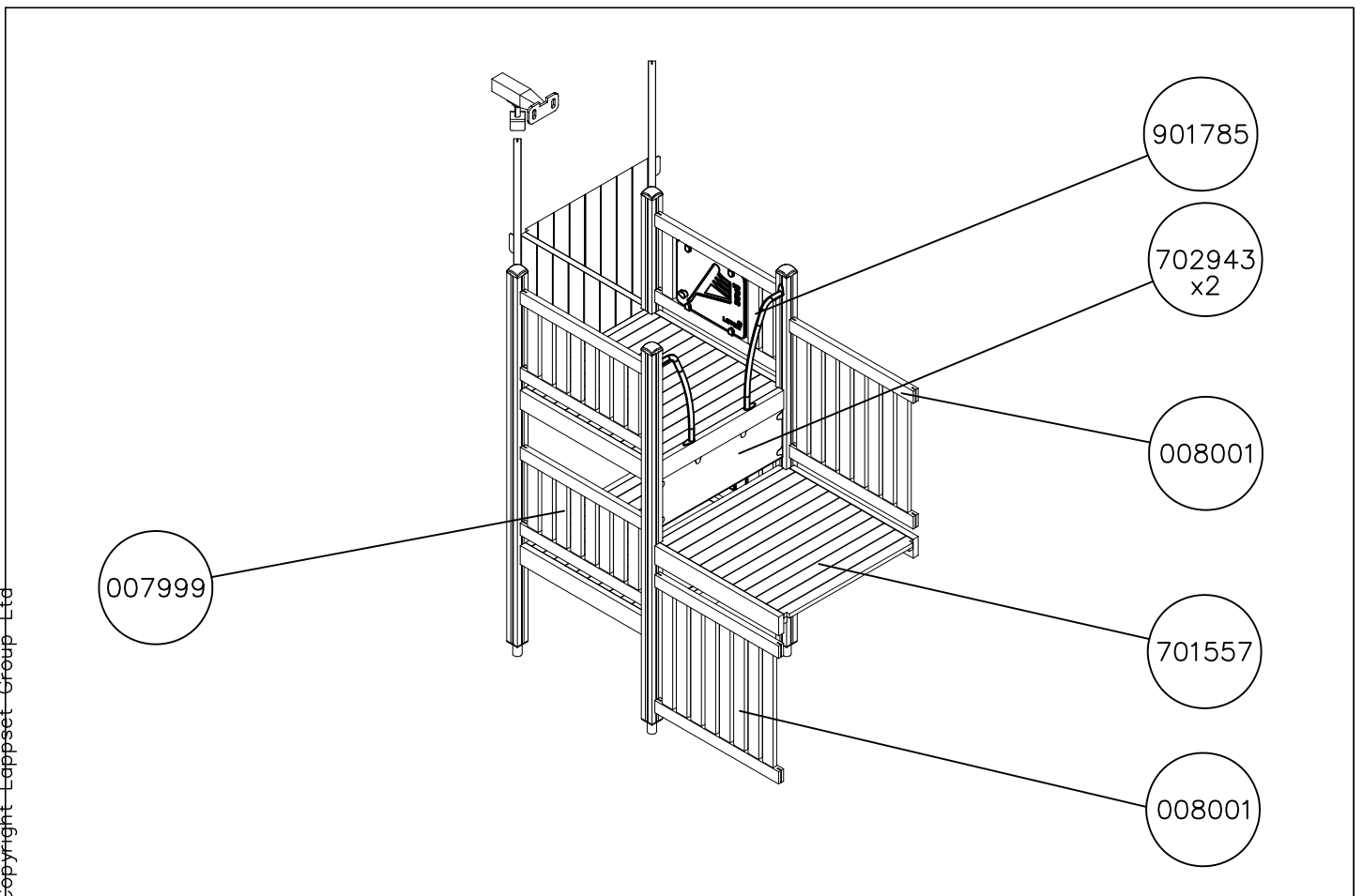
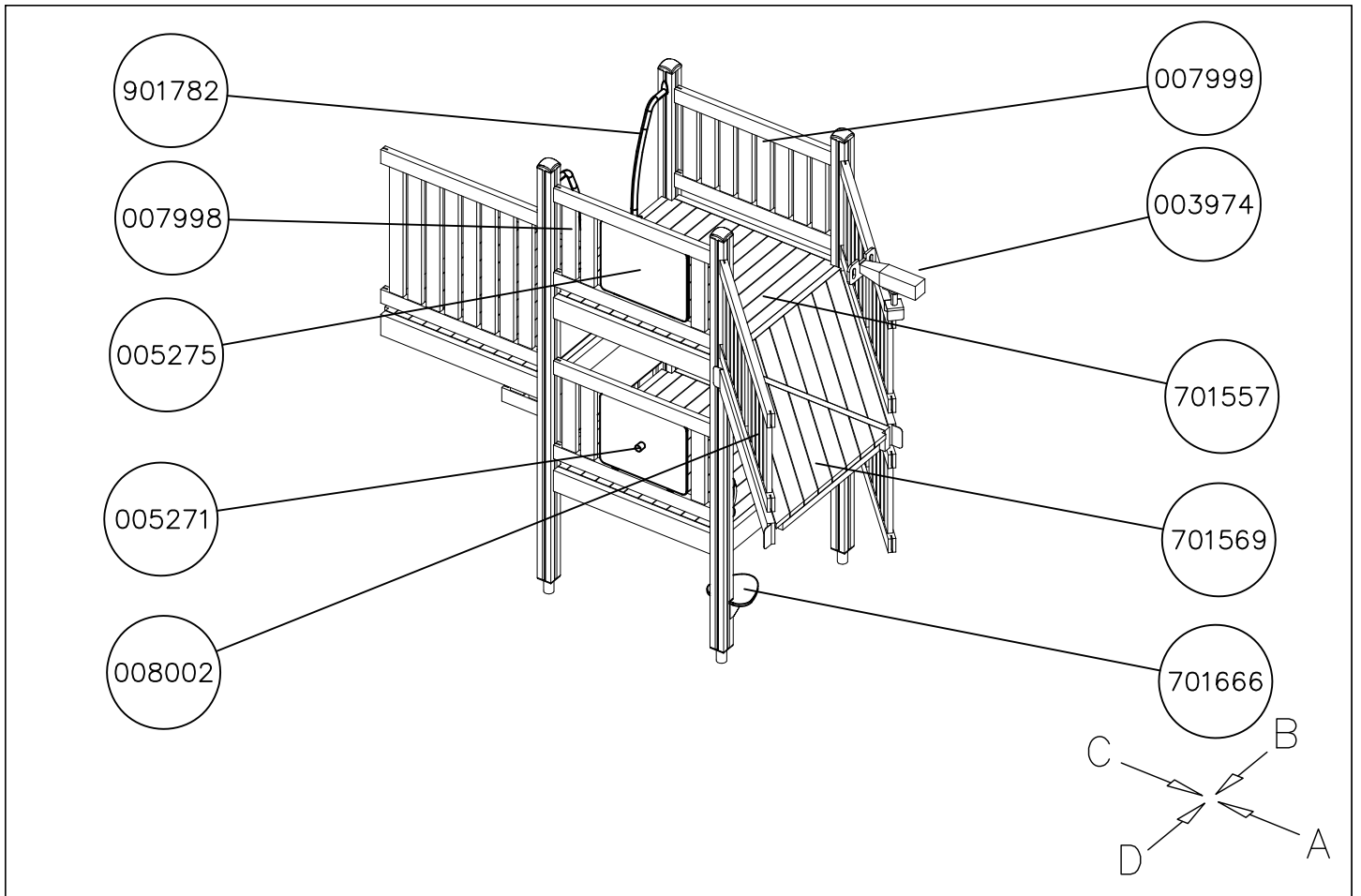

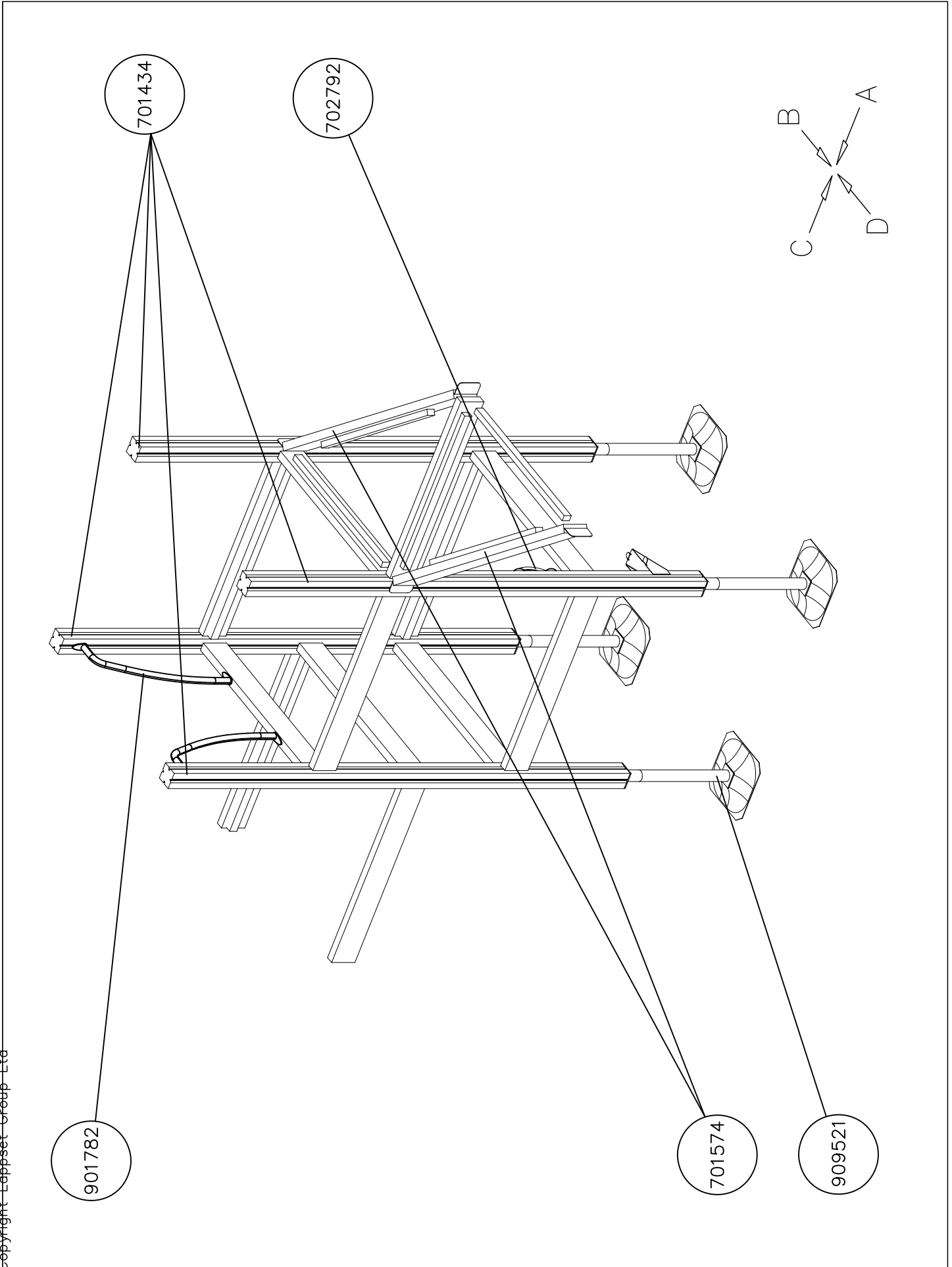

1:50

(A)

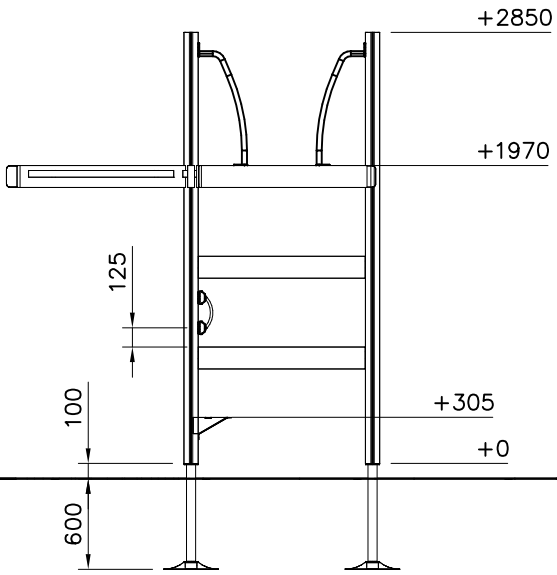

(B)

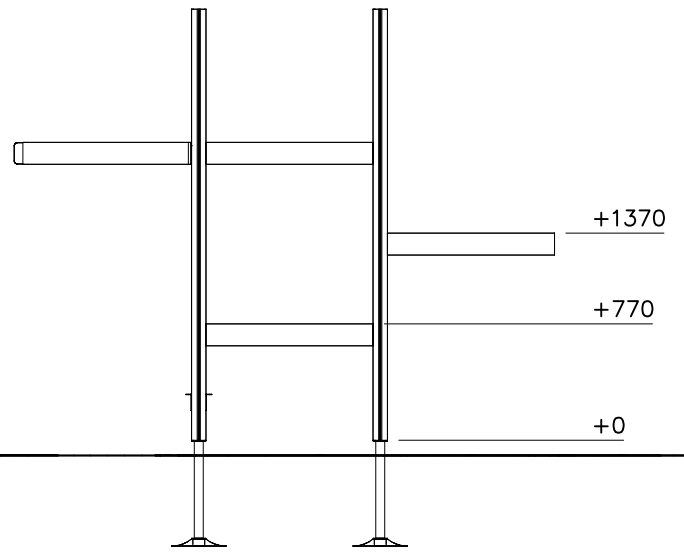

(C)

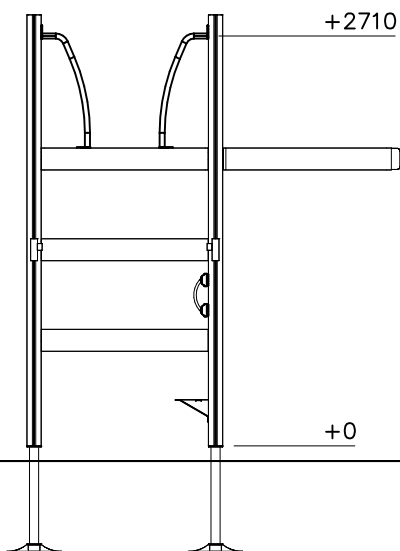

(D)

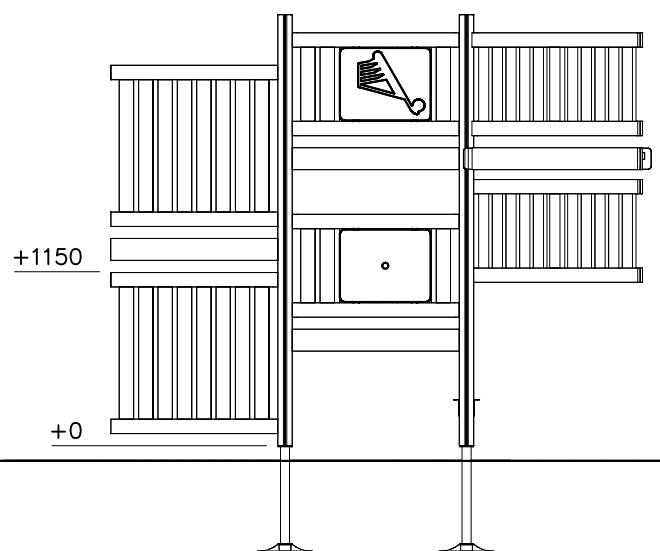

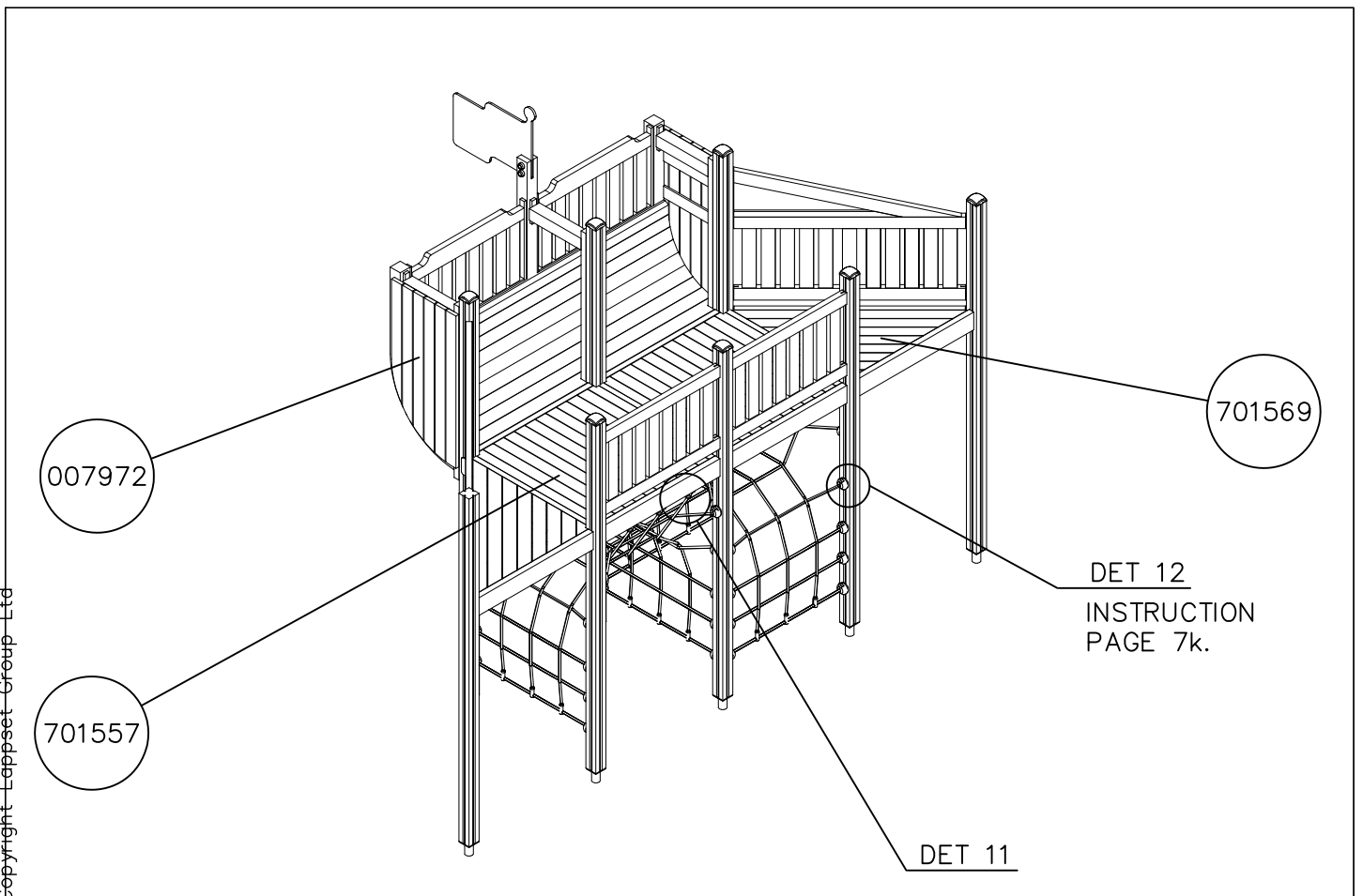
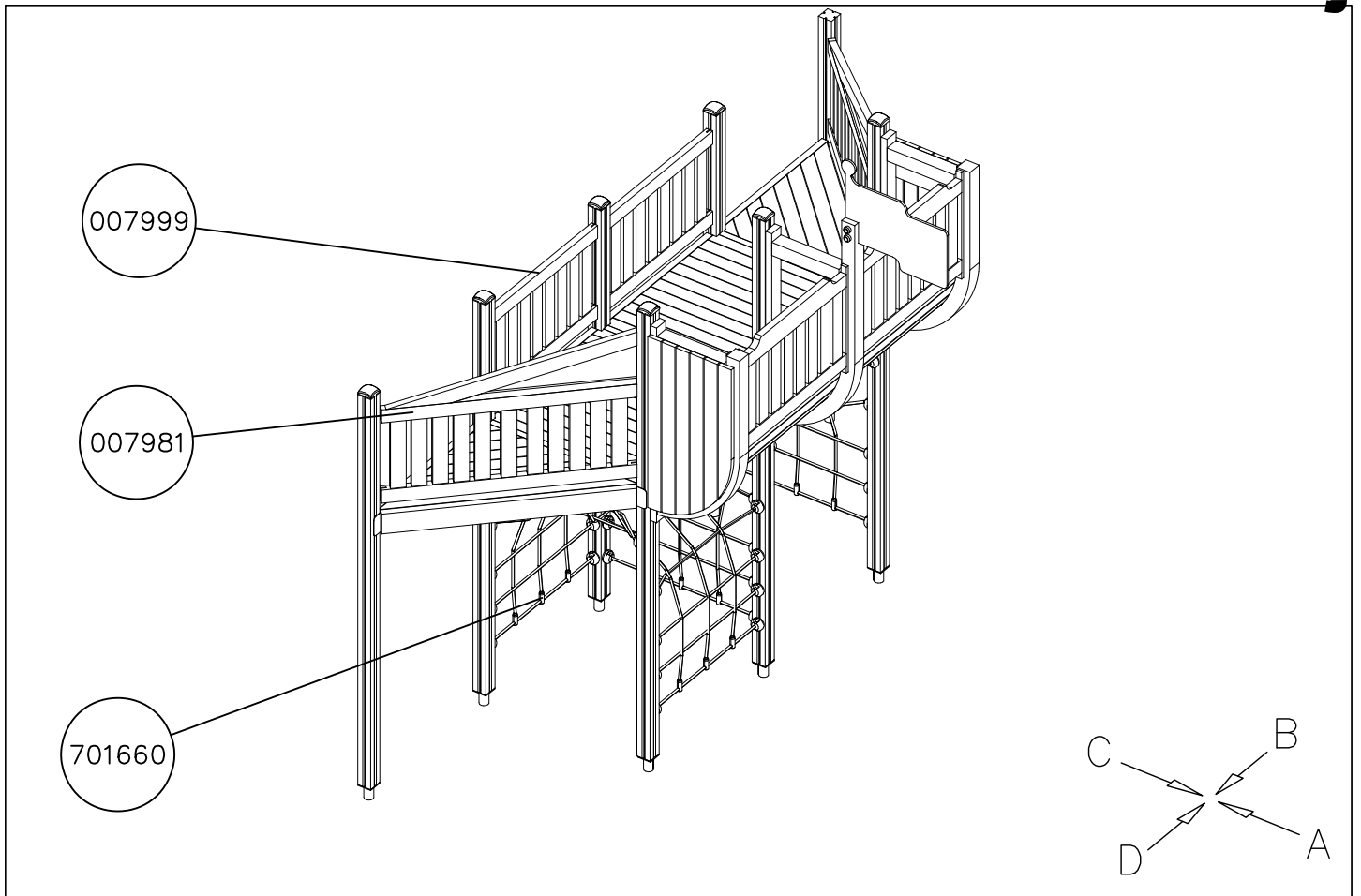

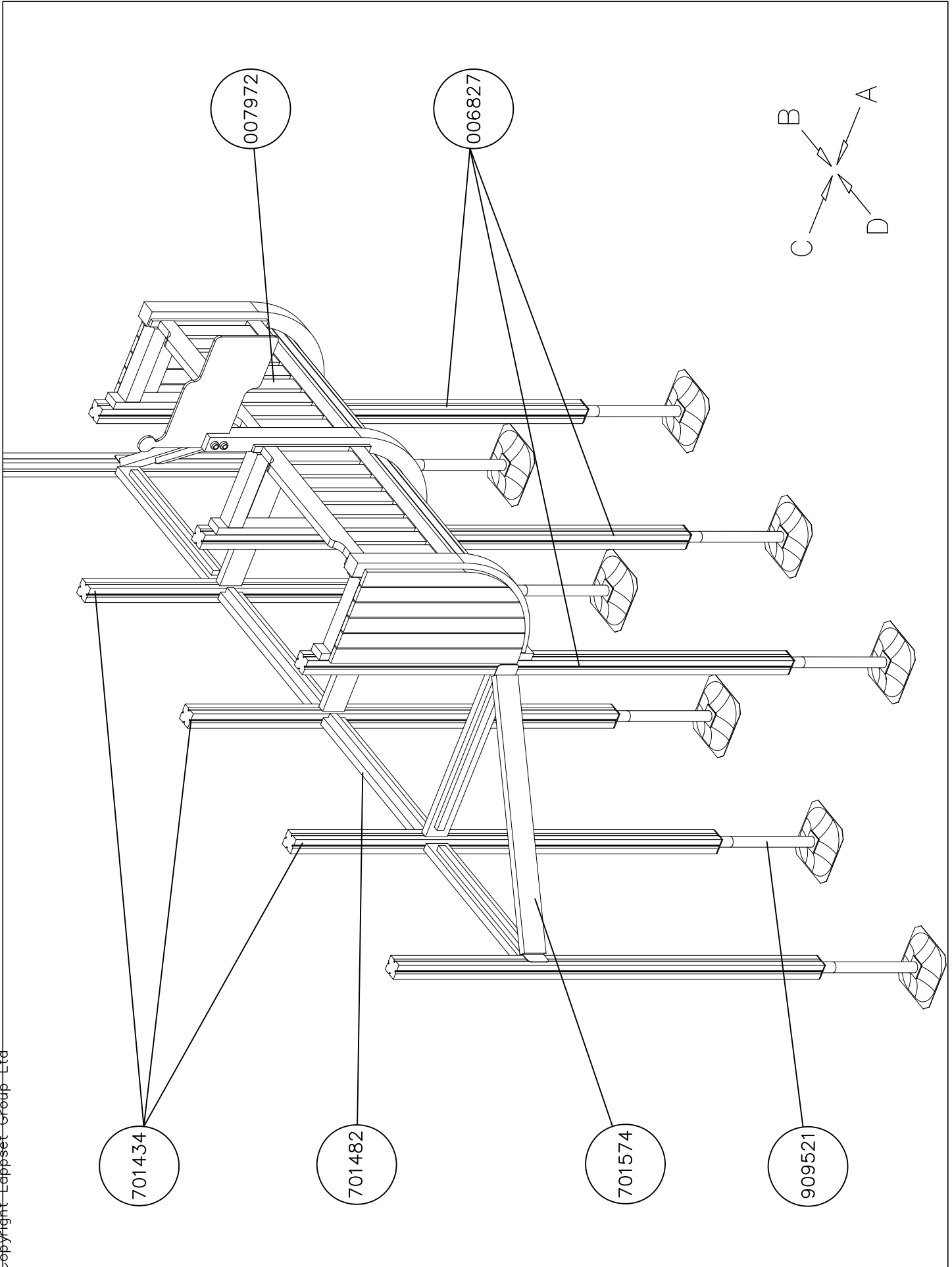

1:50

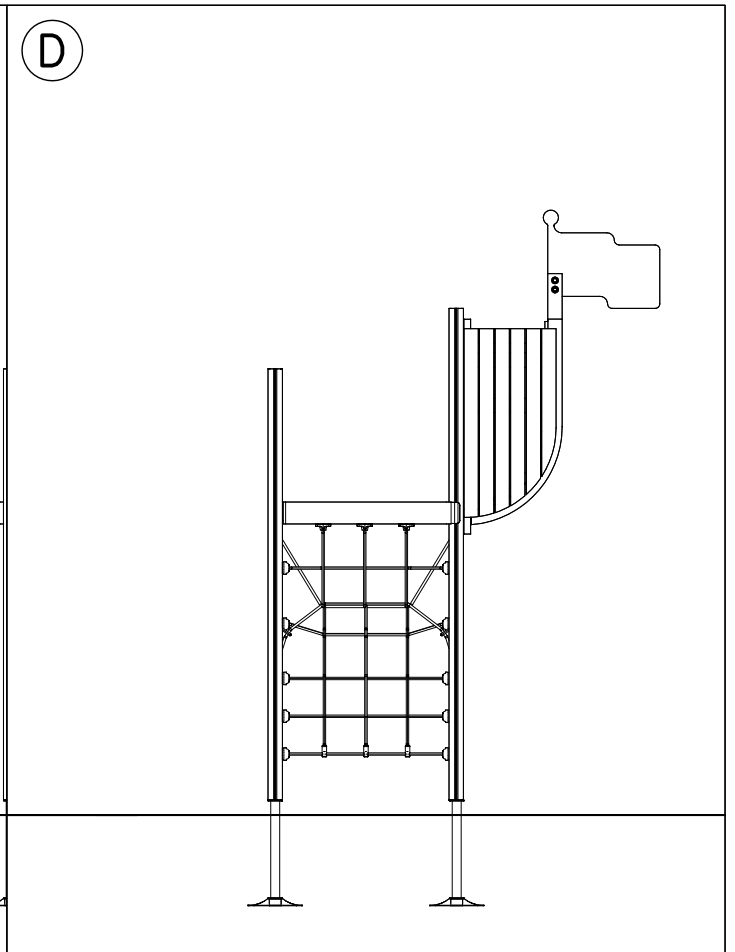
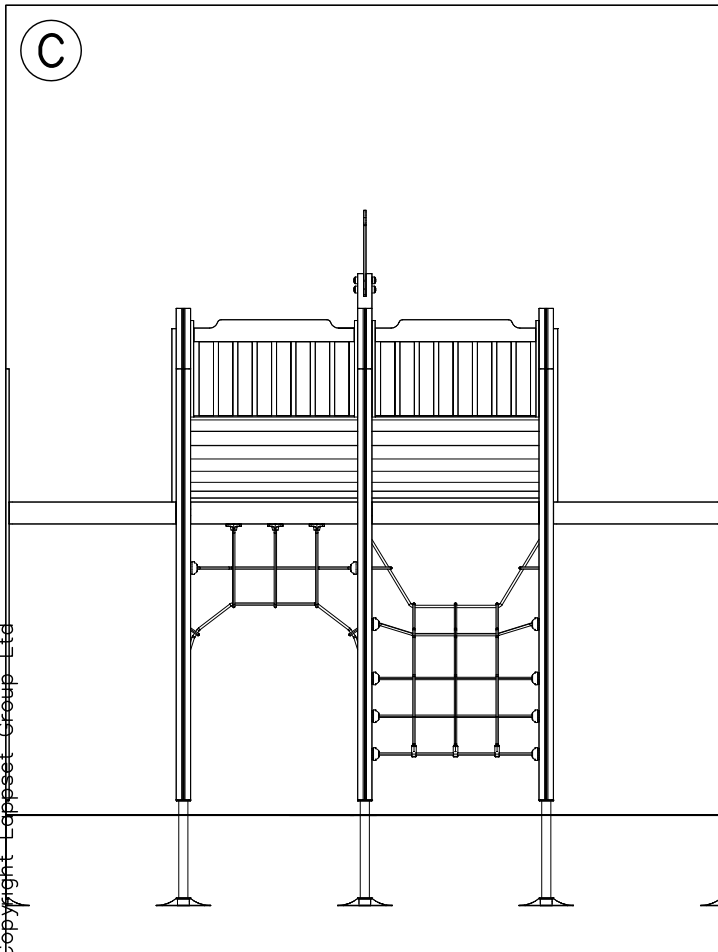
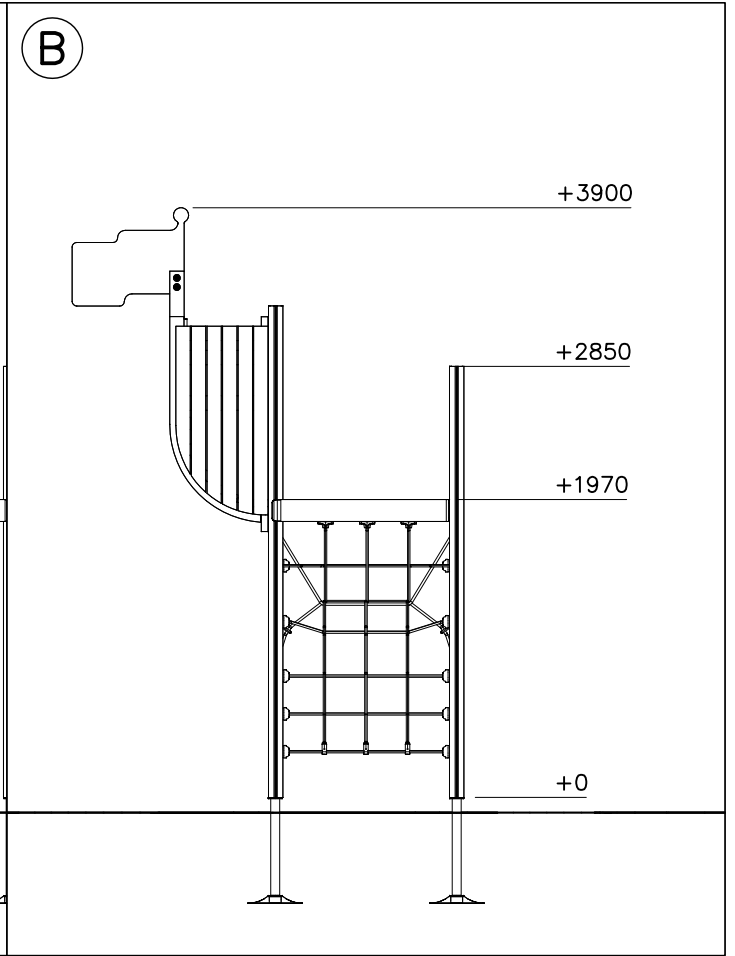
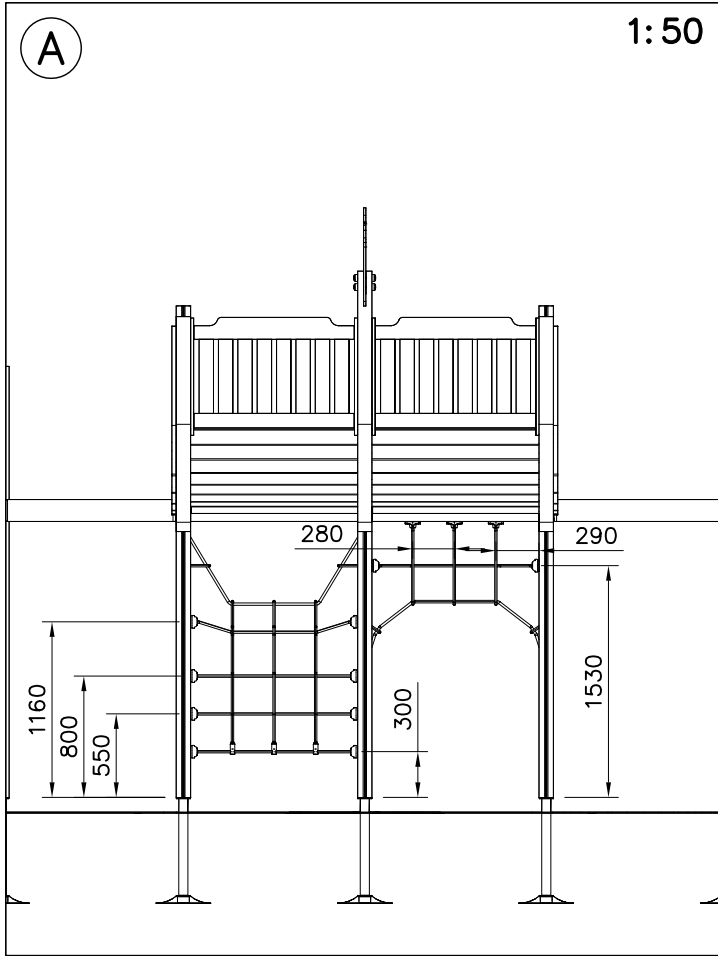

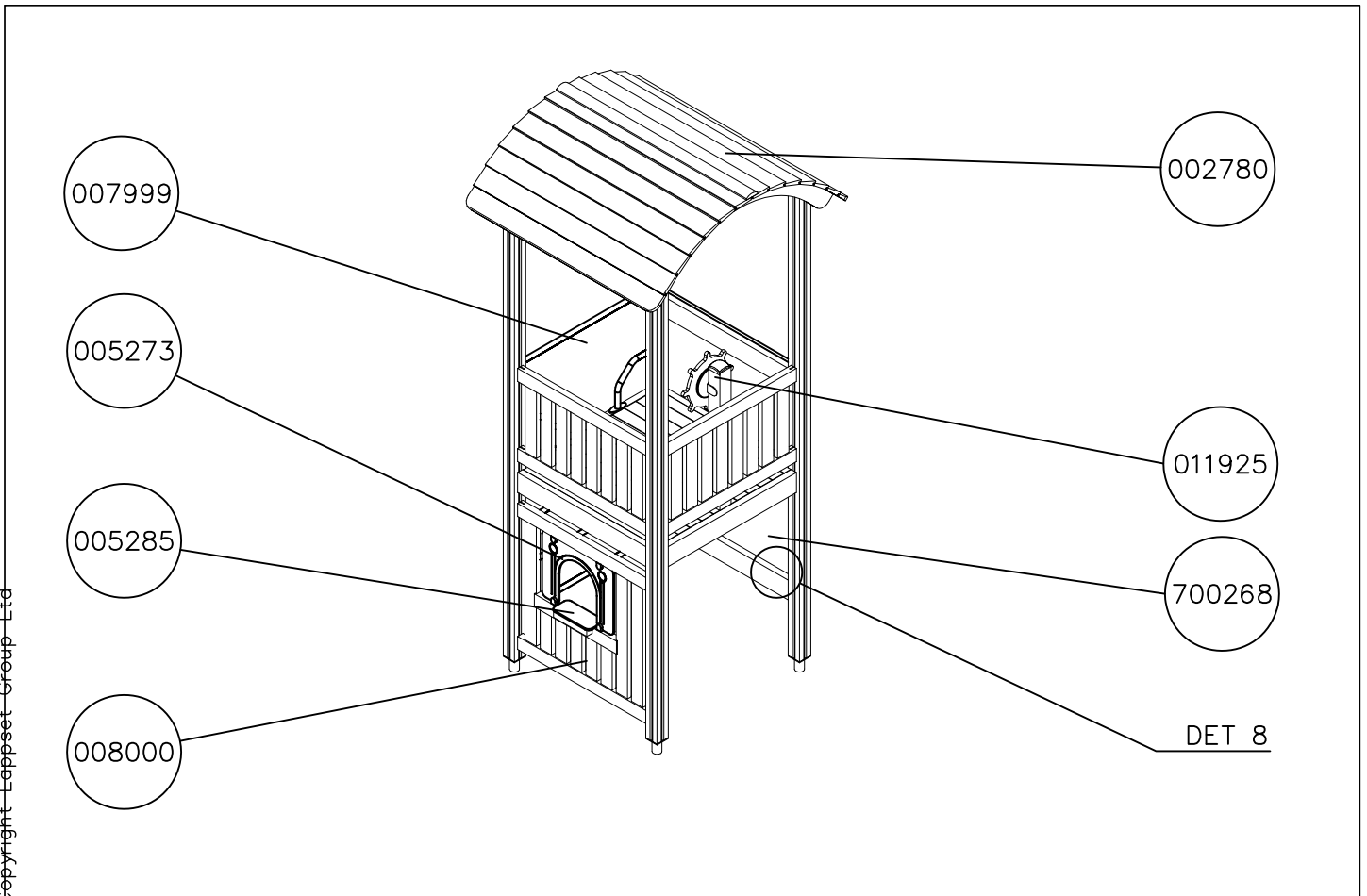
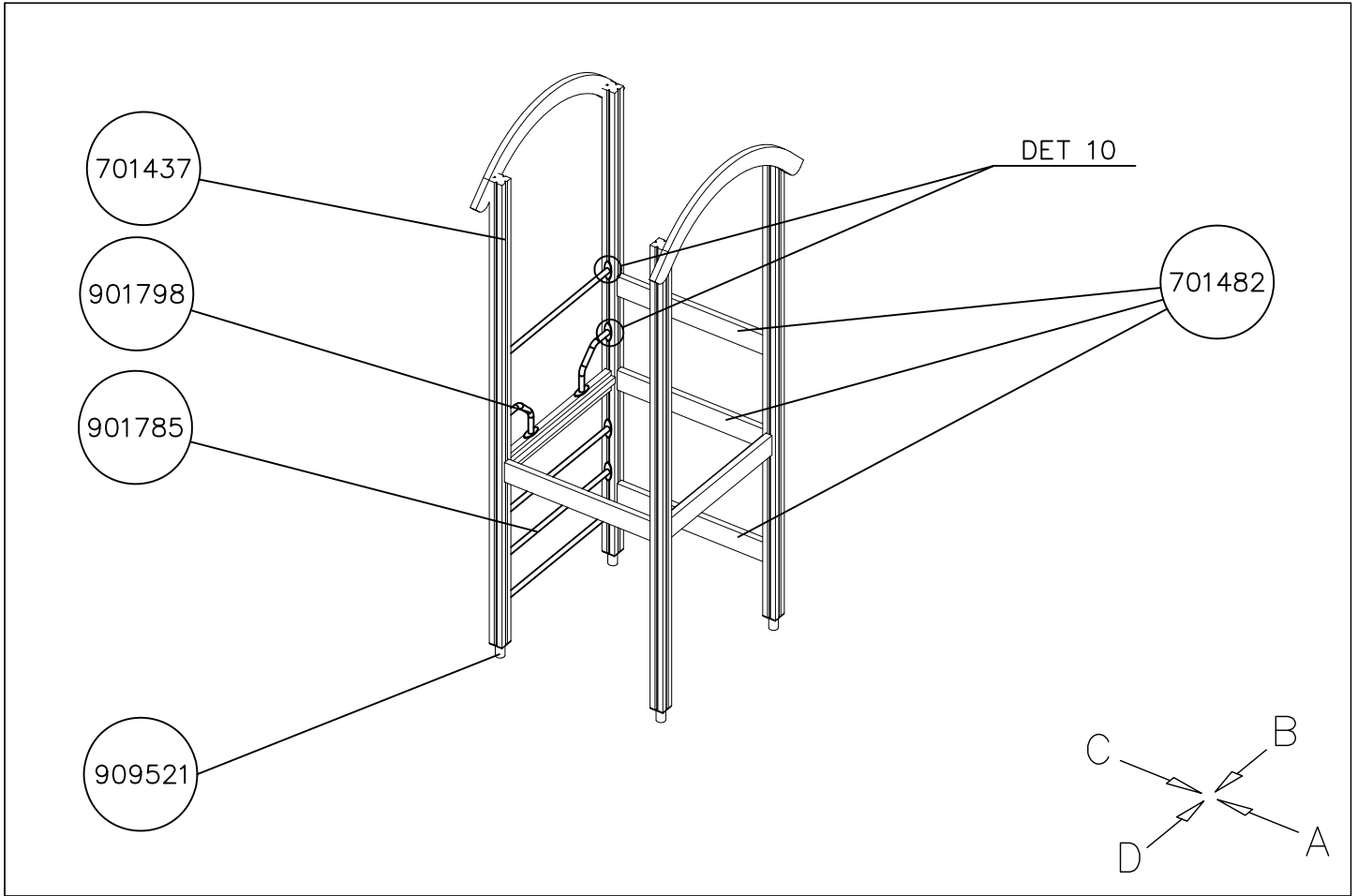

1:50

(A)

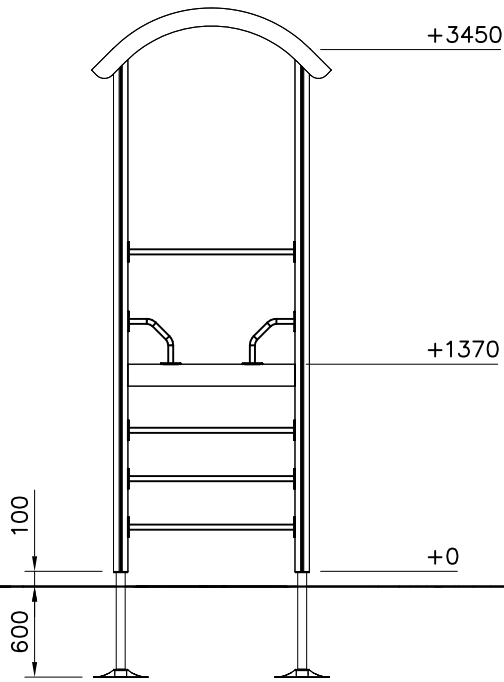

(B)

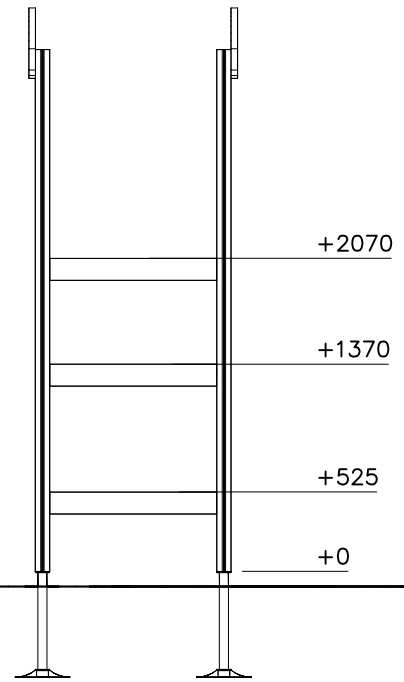

(C)

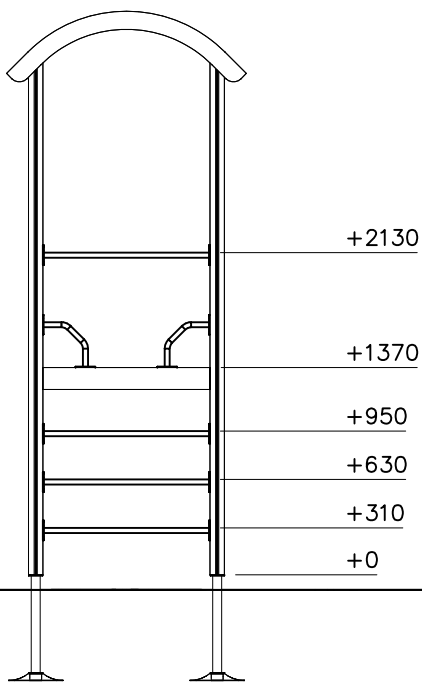

(D)

