

LAPPSET®

FINNO







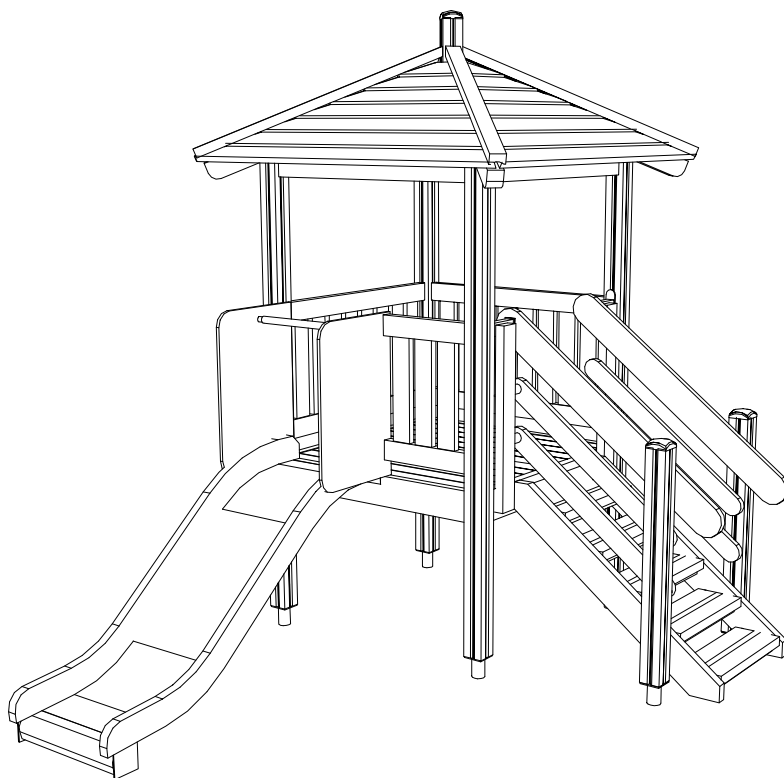

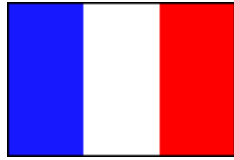
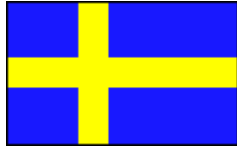

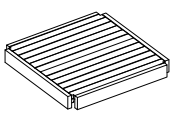

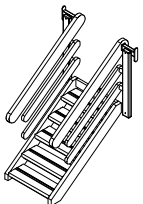

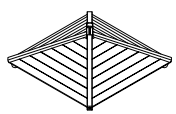

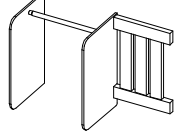

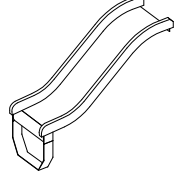
ASENNUSOHJE
MONTERINGSANSVISNING
INSTALLATION INSTRUCTION
AUFBAUANLEITUNG
NOTICE D'INSTALLATION

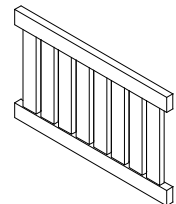
REF: 120347
DATE: 15.6.2003

120347



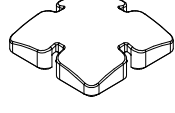
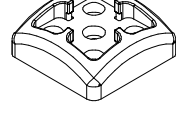
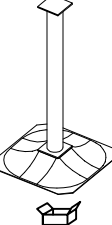

001770  	PCS 1	001848  	PCS 1	002799  	PCS 1	003010  	PCS 1	003618  	PCS 1	003787   BLUE	PCS 2
006810  L 1050	PCS 2	006822  L 2250	PCS 4	905104  M10	PCS 24	905120  Ø14	PCS 12	905138  GREY	PCS 2	905196  GREY	PCS 2
909521  	PCS 6	980131  6x60	PCS 8		PCS		PCS		PCS		PCS
	PCS		PCS		PCS		PCS		PCS		PCS
	PCS		PCS		PCS		PCS		PCS		PCS
	PCS		PCS		PCS		PCS		PCS		PCS
	PCS		PCS		PCS		PCS		PCS		PCS

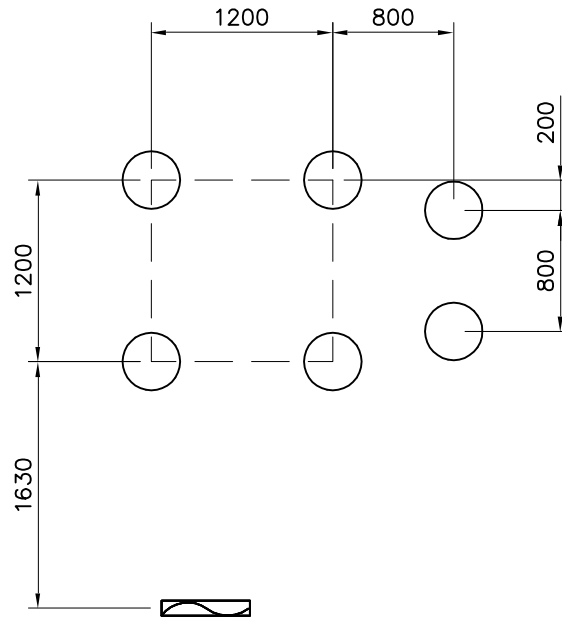
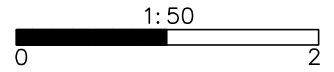

<p>M10 905104 909521</p>	<p>Sand 0.2-2 mm/ Gravel 2-8 mm 100 300 600</p>	<p>Sand 0.2-2 mm/ Gravel 2-8 mm 300 400</p>	

EN Impact Area 23.4 m²

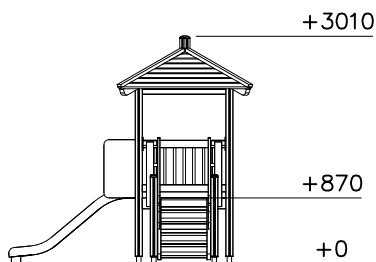
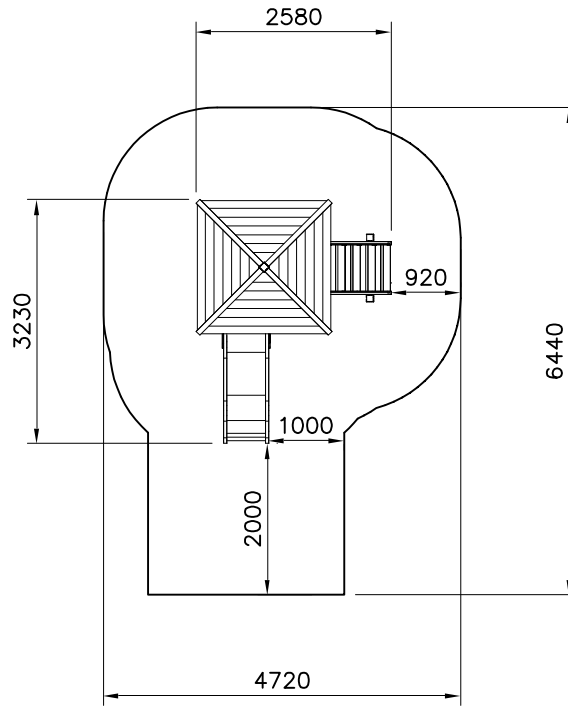
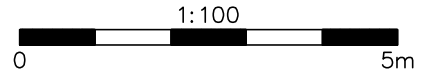

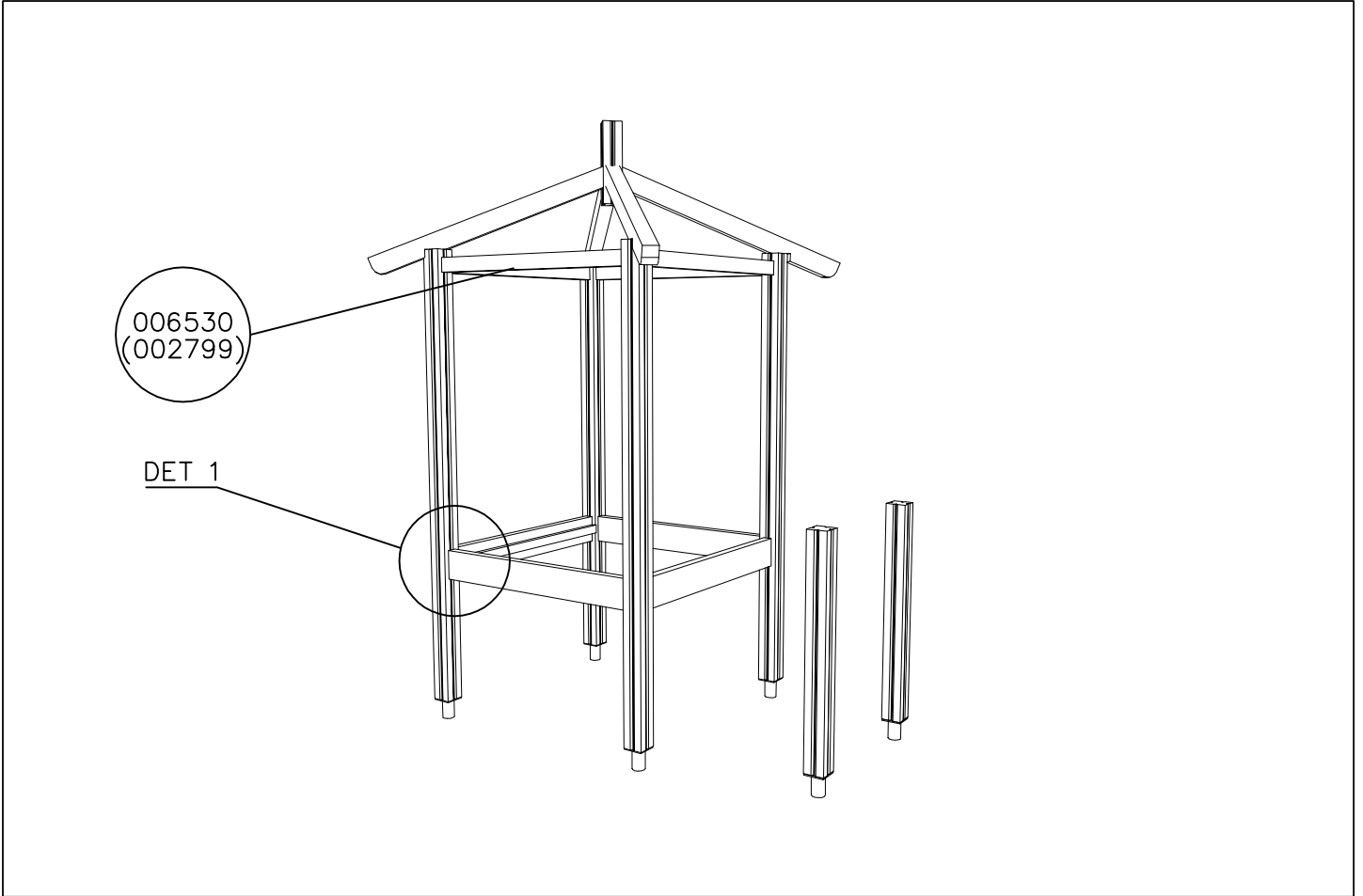

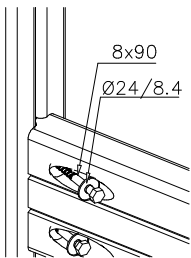
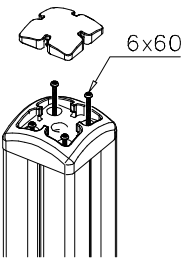
DET 1 	DET 2 	DET 3 