

① 702286	PCS	② 704690	PCS
	1		1
90x50		15mm	
③ 704699	PCS	④ 705101	PCS
	1		1
300x210x210			
⑤ 903192	PCS	⑦ 903870	PCS
	1		3
20x200		M10x40	
		⑧ 903191	PCS
			2
		M10x35 (902252)	
		Ø20/10.5x2 (901302)	
		M10 (909637)	
		19x21x25 (903193)	
	PCS		PCS
	PCS		PCS
	PCS		PCS

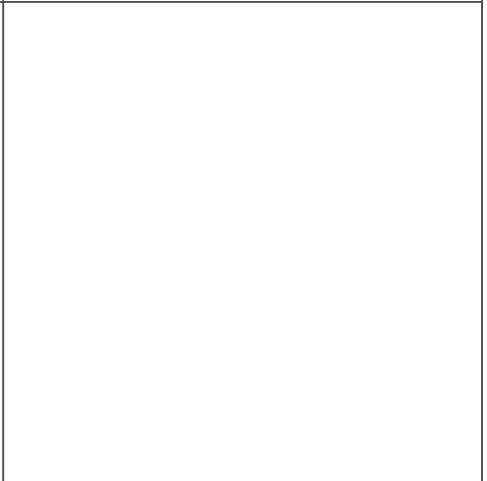

— EN Impact Area 7.7 m²
 - - - Falling Space 7.7 m²
 Max Falling Height 420 mm

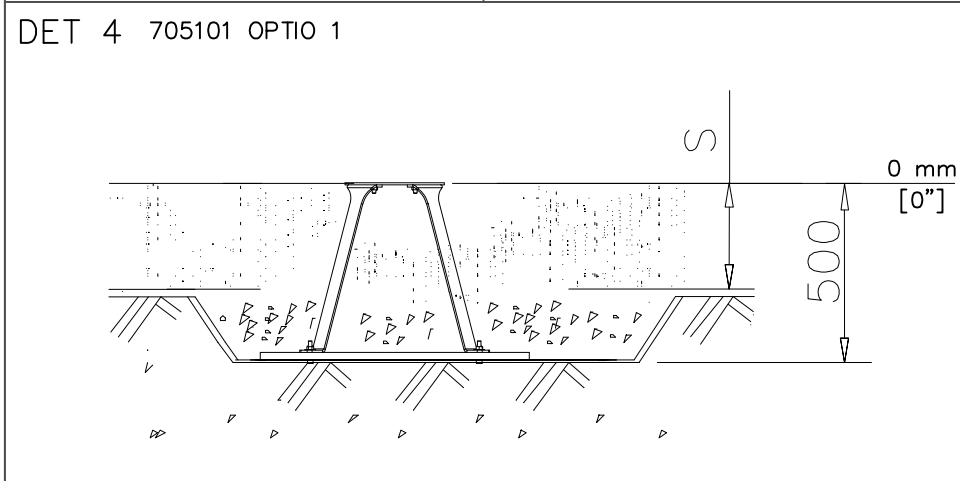
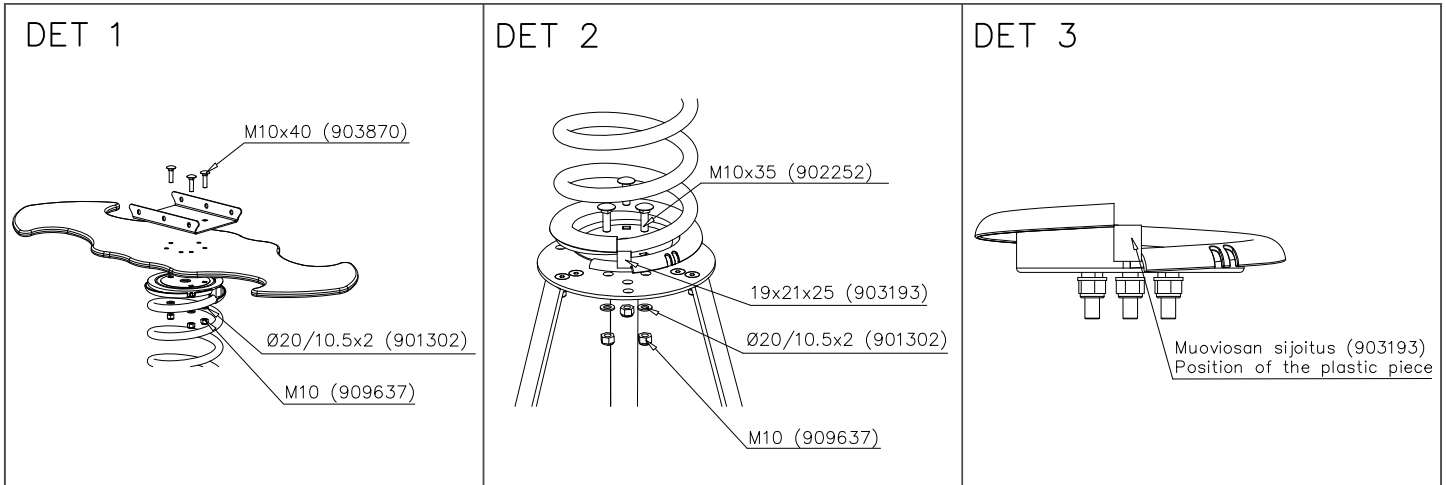
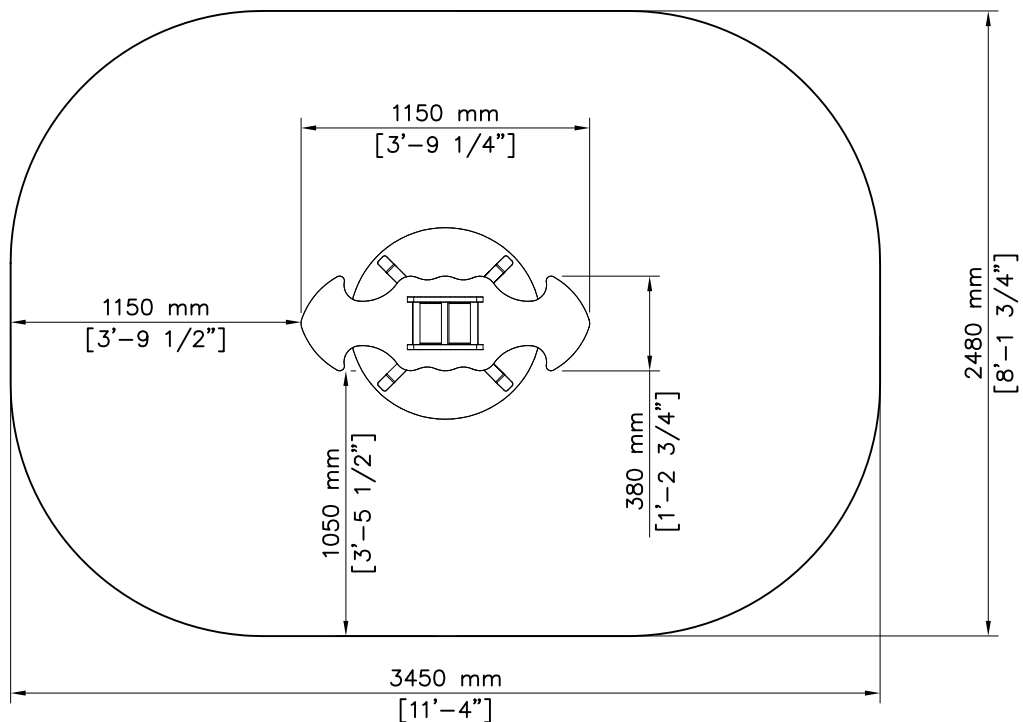

096320



CLOXX

DATE: 2.3.2021

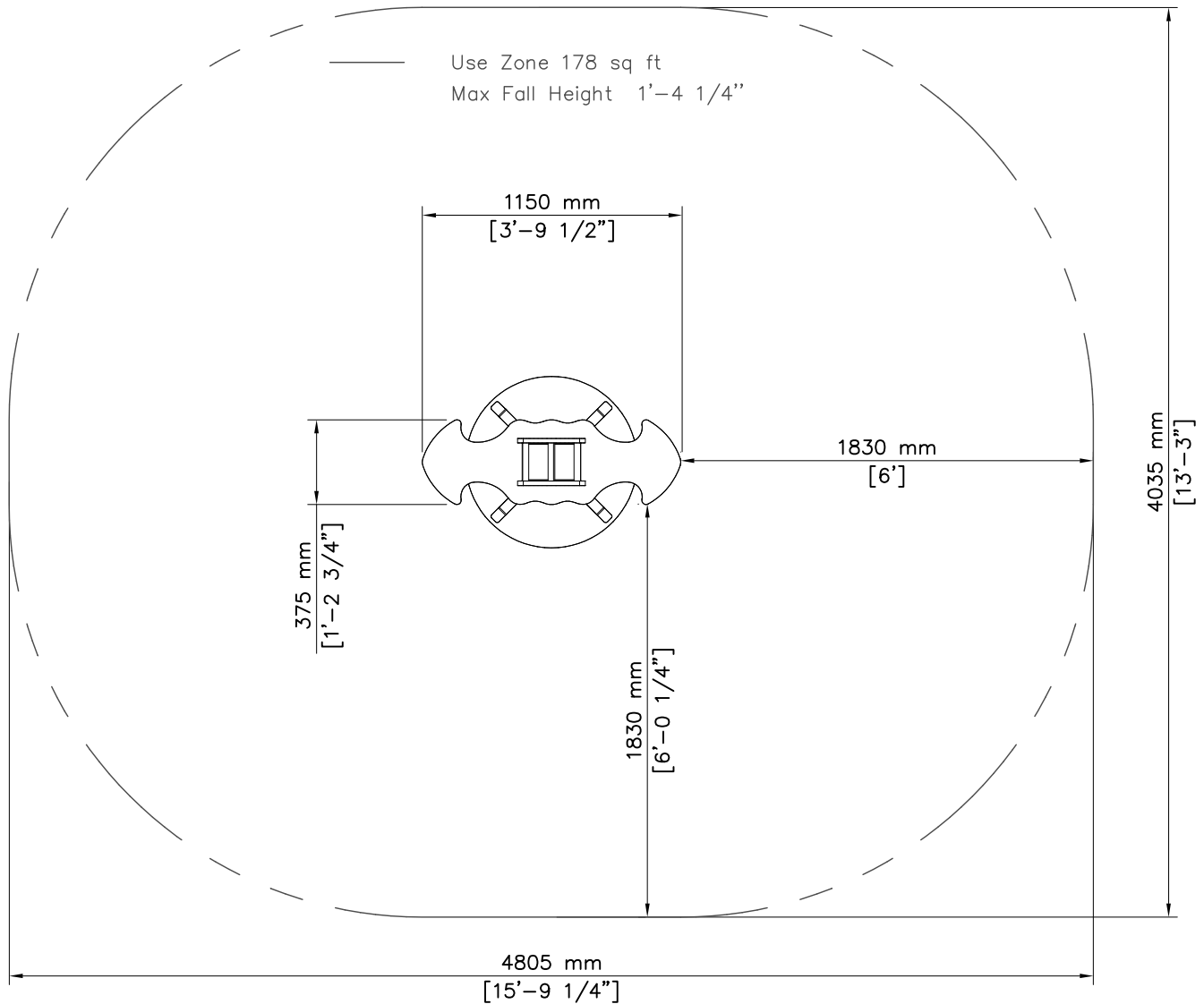
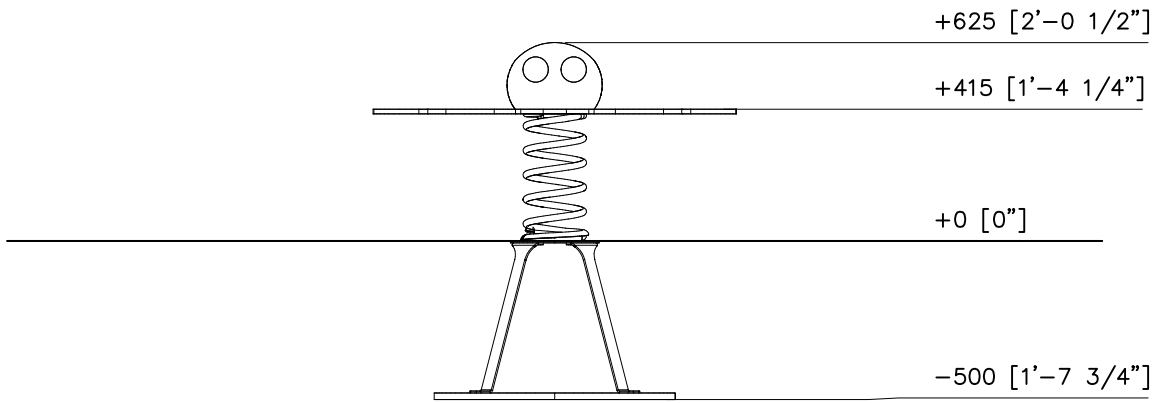
3(3)

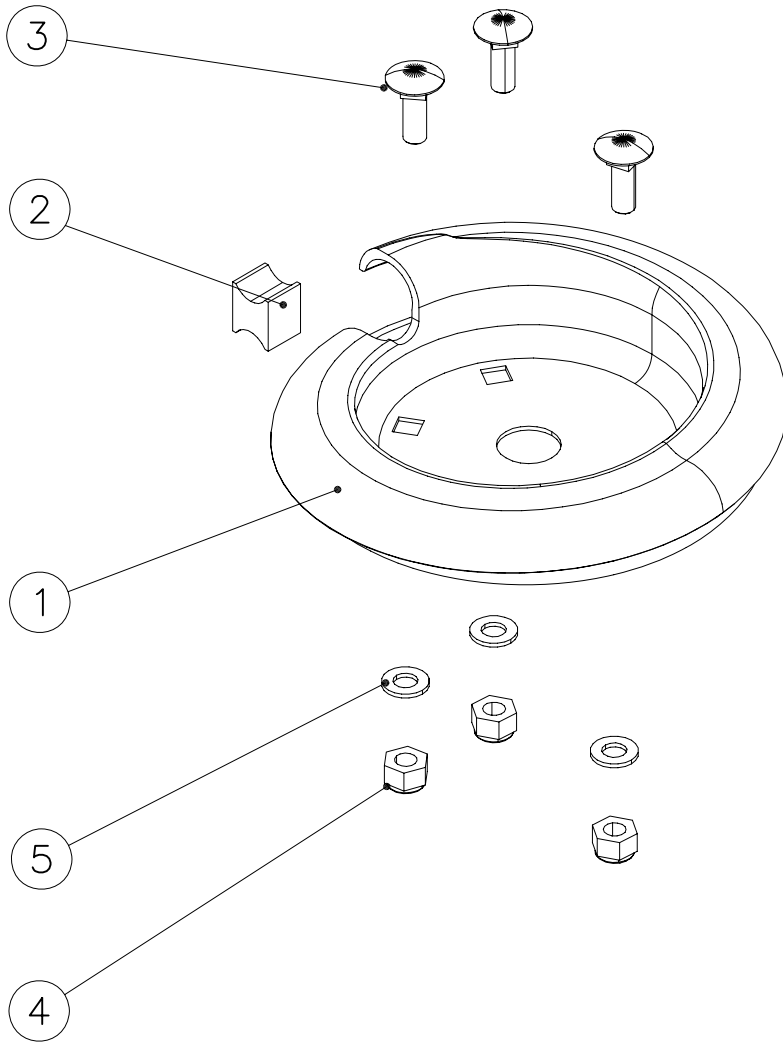

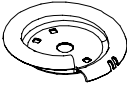
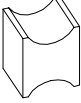
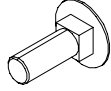

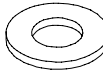
①	PCS 1	②	PCS 1
			
		19x21x25	
③	PCS 3	④	PCS 3
			
M10x35		M10	
⑤	PCS 3		PCS
			
Ø20/10.5			
	PCS		PCS
	PCS		PCS
	PCS		PCS
	PCS		PCS

Jousen ja kiinnityslevyn kiinnittäminen

Fixing the spring and gable plate

Aseta jousen kiinnityslevy jousen kierteiden väliin.
Place the spring berch between the bottom coils



Kierrä kiinnityslevyä kohti kiinnitysalustaa.
Turn the spring berch towards the anchor



Aseta muovipala kiinnityslevyn kierteen aloitus- ja lopetus osan väliin kuvan osoittamalla tavalla.

Place the plastic piece between coils as shown below



Kierrä kiinnitys levyä myötäpäivää, kunnes muovipala koskettaa jousen kierrettä.

Turn the spring berch clockwise until the plastic piece is in contact to coils below and underneath.

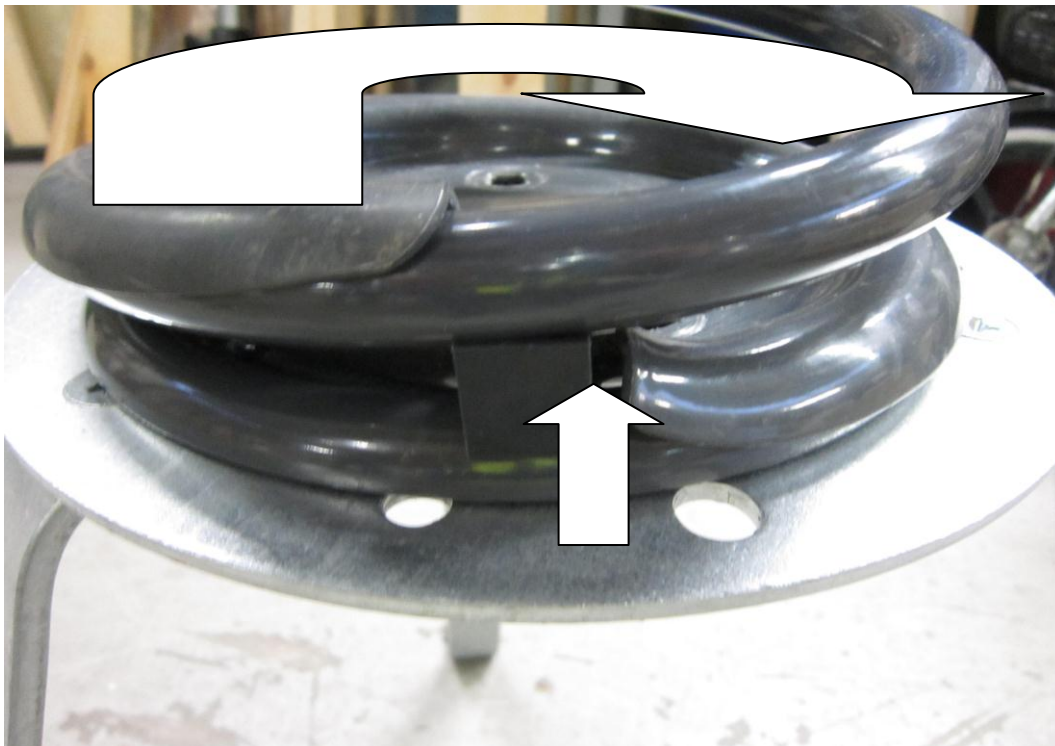

Kohdista kiinnityslevyn pulttien reiät ja perustuksen kiinnitysreiät kohdalleen. 5mm – 10mm rako ennen kiristystä.

Center the fixing holes of anchor and spring berch. There should be 5-10 mm gap between the parts prior to tightening.

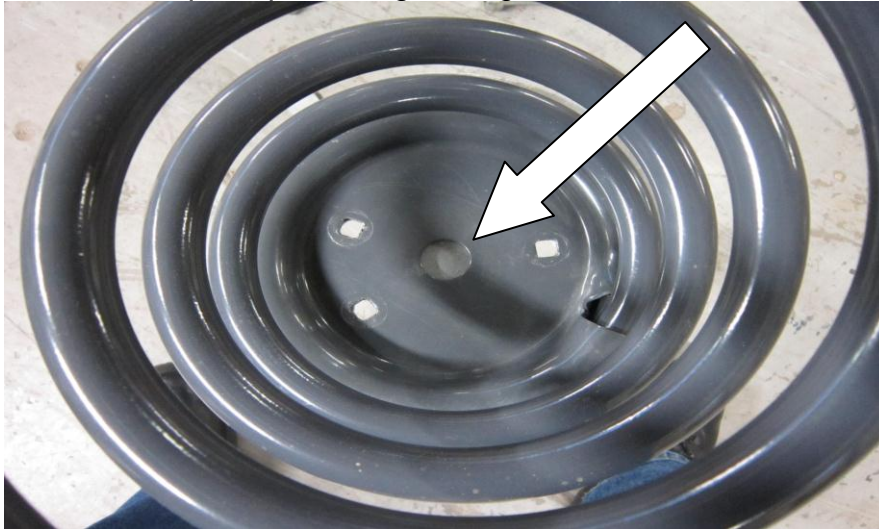

Kiristä huolellisesti pultit vuorotellen kiristäen. Kiristuksen jälkeen osien välillä saa olla korkeintaan 1mm rako keskireiästä katsoen.

Tighten the bolts gradually, about 1 turn at the time. After the tightening, there must not be more than 1mm gap between the parts





Tuotekyltti tulee tuotteen mukana yhdellä seuraavista tavoista:

1) Metallinen tuotekyltti ja kiinnitysruuvit

- Kiinnitä tuotekyltti ruuveilla tolppaan noin 2 metrin korkeuteen kuvan 1 mukaisesti.

2) Tuotekylttitarra

- Puhdista maalattu metalli- tai vaneripinta pölystä ja kosteudesta. Liimaa tarra kuvan 2 mukaisesti.
- Huom. Älä kiinnitä tarraa karheapintaiseen laminaattiin tai maalattuun puuhun.

Vår produktmärkning levereras på ett av följande sätt:

1) Produktskylt i metall

- Fäst skylten med de medföljande skruvarna

2) Självhäftande produktetikett

- Rengör den pulverlackerade metallytan eller laminatyten så att den blir fri från smuts och fukt. Fäst etiketten enligt fig. 2.
- Obs! Fäst ej etiketten på detaljer med skrovlig yta eller på målat trä.

Product label is delivered by one of following ways:

1) Metal product label and screws

- Fasten the label with screws.

2) Label sticker

- Clean the painted metal or plywood surface from dirt and moisture. Fasten the sticker as shown in the figure 2.
- Note. Do not attach the sticker to rough surfaced laminate or painted wood.

La plaque d'informations produit est livrée sous l'une de ces 3 formes :

1) Plaque métallique et vis

- Fixez la plaque à l'aide des vis.

2) Etiquette autocollante

- Avant de coller l'étiquette, nettoyez le composant métallique peint ou la plaque de contreplaqué, de toute saleté. La surface doit être sèche (voir image 2).
- Attention, ne pas coller l'étiquette sur une surface lamellé-collée irrégulière ou sur du bois peint.

Die Auslieferung des Produktaufklebers erfolgt auf eine dieser Arten:

1) Produkt-Schild aus Metall incl. Schrauben

- Die Befestigung des Schildes erfolgt mittels der Schrauben.

2) Aufkleber

- Entfernen Sie zunächst Schmutz und Feuchtigkeit vom lackierten Metall bzw. von der Holzoberfläche und bringen Sie den Aufkleber wie im Bild oben rechts beschrieben auf den gesäuberten Untergrund auf.
- Beachten Sie: Bringen Sie den Aufkleber nicht auf raues laminiertes oder lackiertes Holz an.





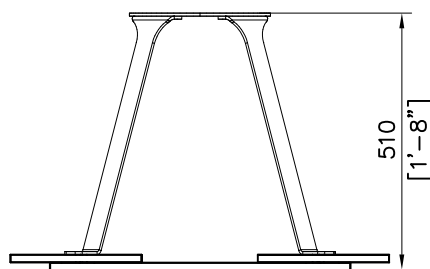
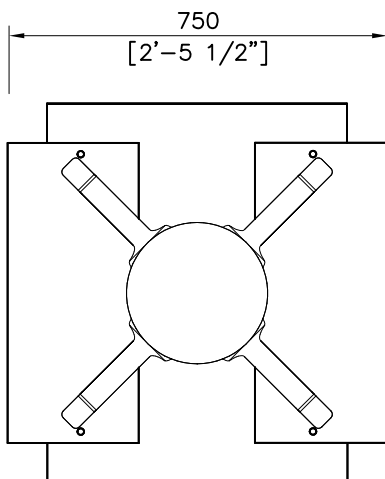
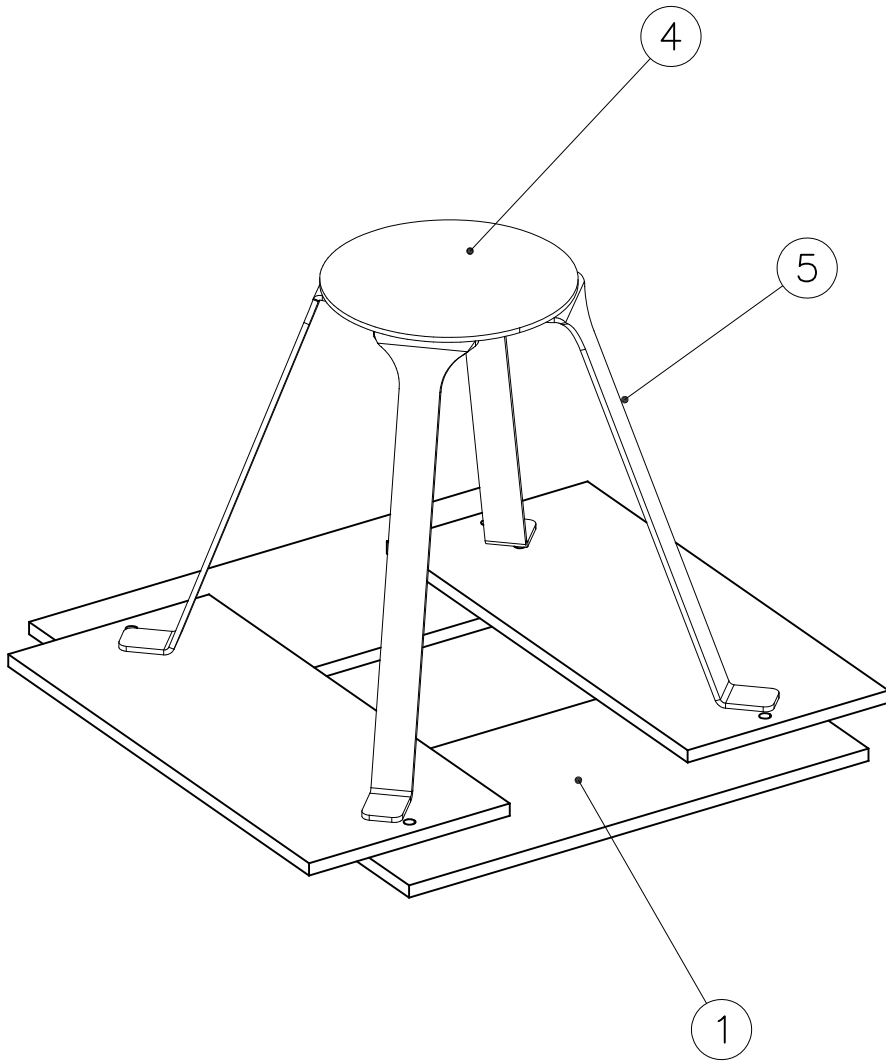

LAPPSET® GROUNDING

705101

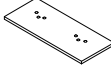
DATE: 5.6.2023

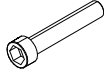
1(2)



①	707138	PCS	②	900958	PCS
		4			8
	260x595			M10x30	
③	902232	PCS	④	905993	PCS
		4			1
	M10x55				
⑤	906000	PCS	⑥	909255	PCS
		4			8
				Ø30/10.5	
⑦	980161	PCS			PCS
		12			
	M10				
		PCS			PCS
		PCS			PCS
		PCS			PCS

DET 1

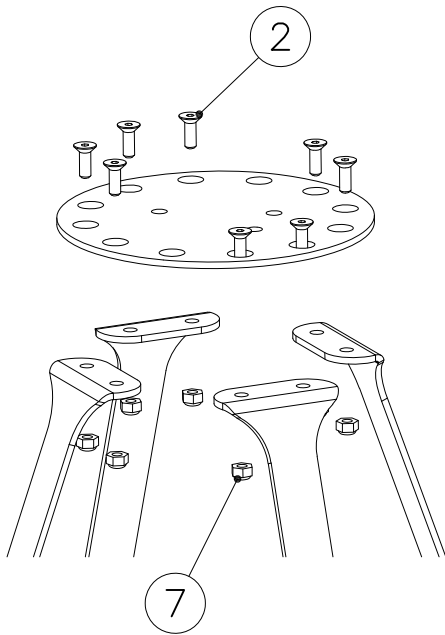

DET 2

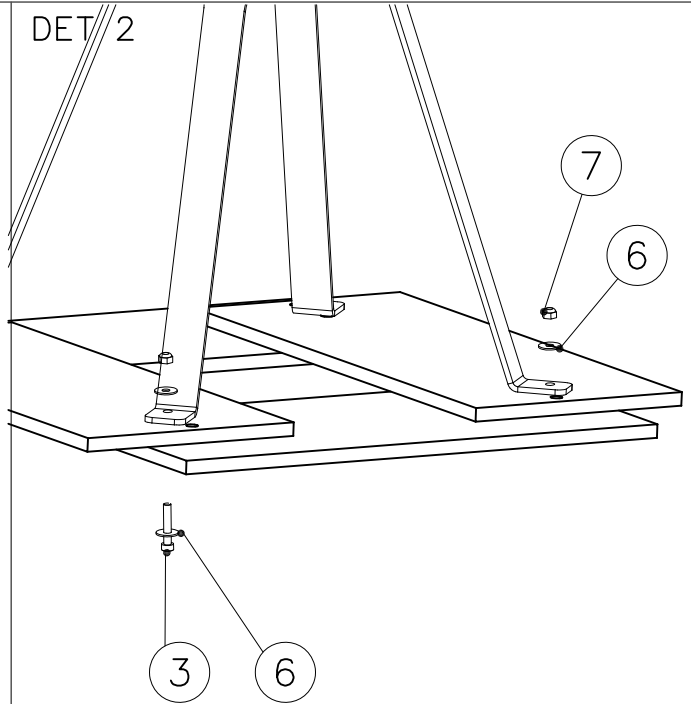

DET 3 OPTIO 1

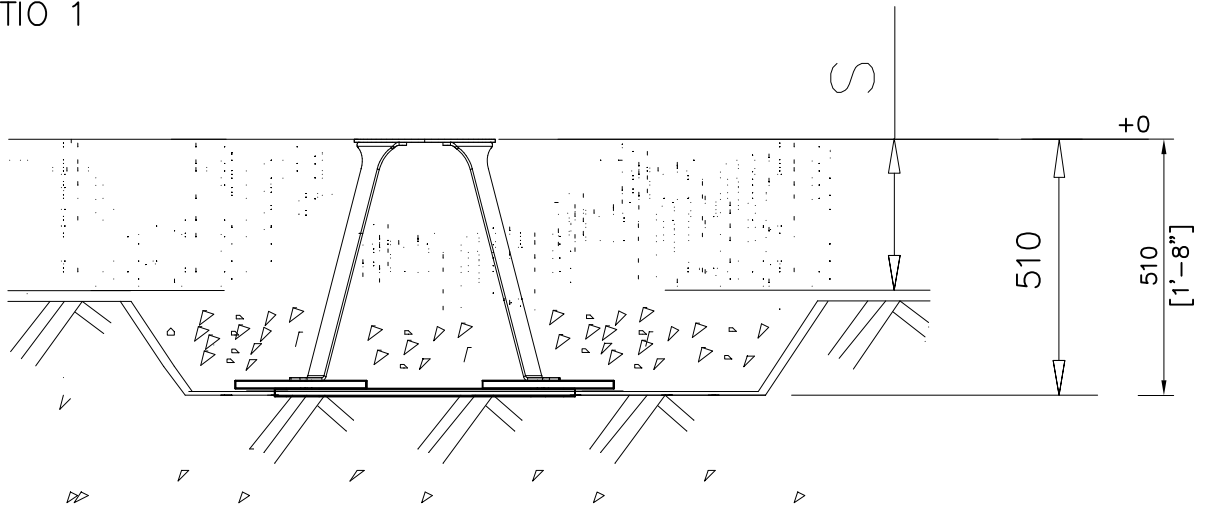

DET 3 OPTIO 2 (WITH CONCRETE)

