

LAPPSET®

FINNO











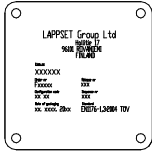

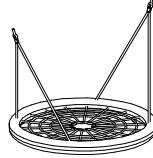

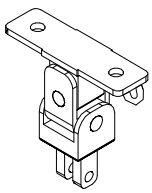

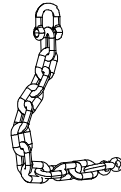
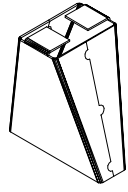

ASENNUSOHJE
MONTERINGSANSVISNING
INSTALLATION INSTRUCTION
AUFBAUANLEITUNG
NOTICE D'INSTALLATION

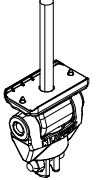
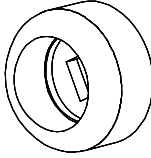
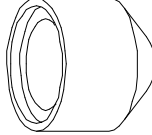
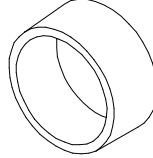
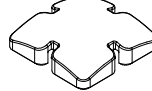
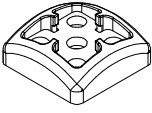
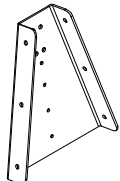
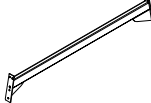
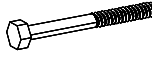
DATE: 13.4.2021

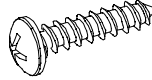
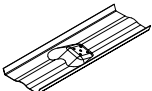
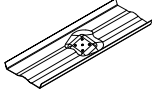
Q13840

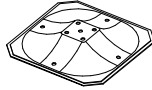
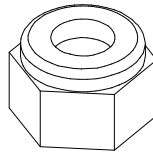
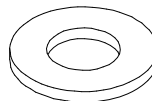
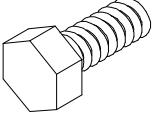
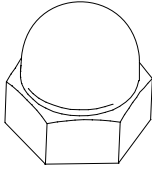

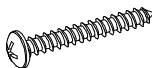
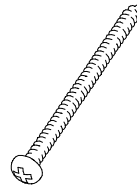
DATE: 13.4.2021

702286  65x65	PCS 1	702533  118x78	PCS 1	706562-603  L2250	PCS 8	706947  M10	PCS 1	900965  M10	PCS 12	901958  L2940	PCS 2
901959  L2940	PCS 1	902234  M12	PCS 4	903149  M12x30	PCS 12	903577  L2940	PCS 2	904317  L2940	PCS 2	904333  L2940	PCS 1
904904  Ø45	PCS 6	905090  M10	PCS 24	905104  M10	PCS 32	905115  Ø30	PCS 24	905138  L 1000	PCS 8	905196  L 1000	PCS 8
905991  L 1000	PCS 2	906216  L650	PCS 1	906499  M12x110	PCS 4	909347  M12x35	PCS 24	909506  Ø3.5x13	PCS 4	909507  L 1000	PCS 2
909508  L 1000	PCS 2	909511  L650	PCS 4	909519  50x380x380	PCS 4	909637  M10	PCS 32	909638  Ø20/10.5	PCS 88	909639  M10x25	PCS 44
909644  M12	PCS 12	911155  L650	PCS 4	980114  Ø4x20	PCS 4	980131  Ø6x60	PCS 32	980154  Ø24x13	PCS 56	999561  10g	PCS 1
	PCS		PCS		PCS		PCS		PCS		PCS

- EN/AS Impact Area 54.9 m²
- Falling Space 54.9 m²

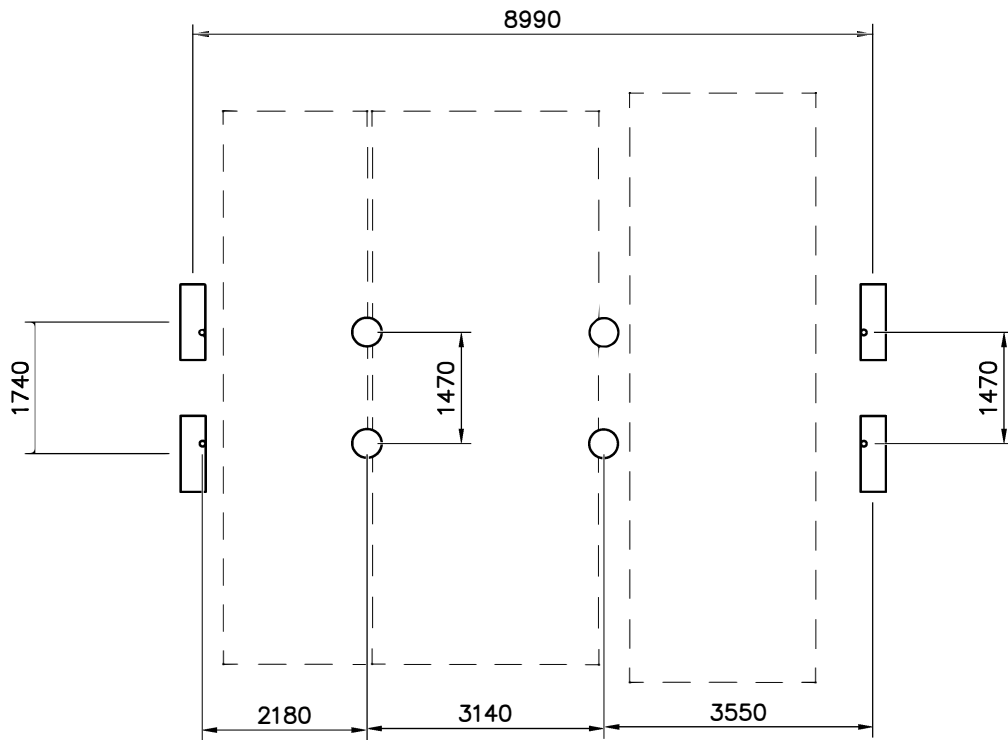

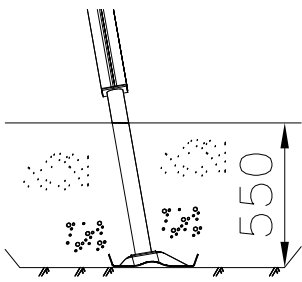
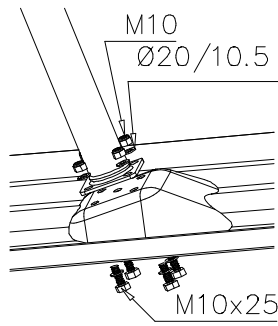
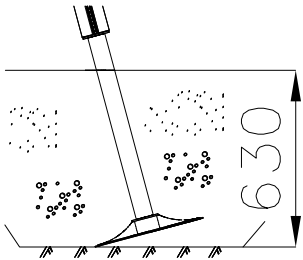
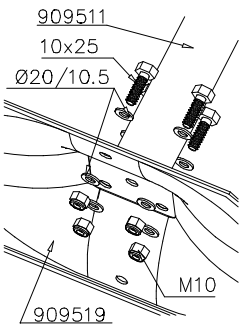
 <p>550</p>	 <p>M10 Ø20/10.5 M10x25</p>	 <p>630</p>
 <p>909511 10x25 Ø20/10.5 M10 909519</p>		

- EN/AS Impact Area 54.9 m²
- - - - Falling Space 54.9 m²
Max Falling Height 1200 mm

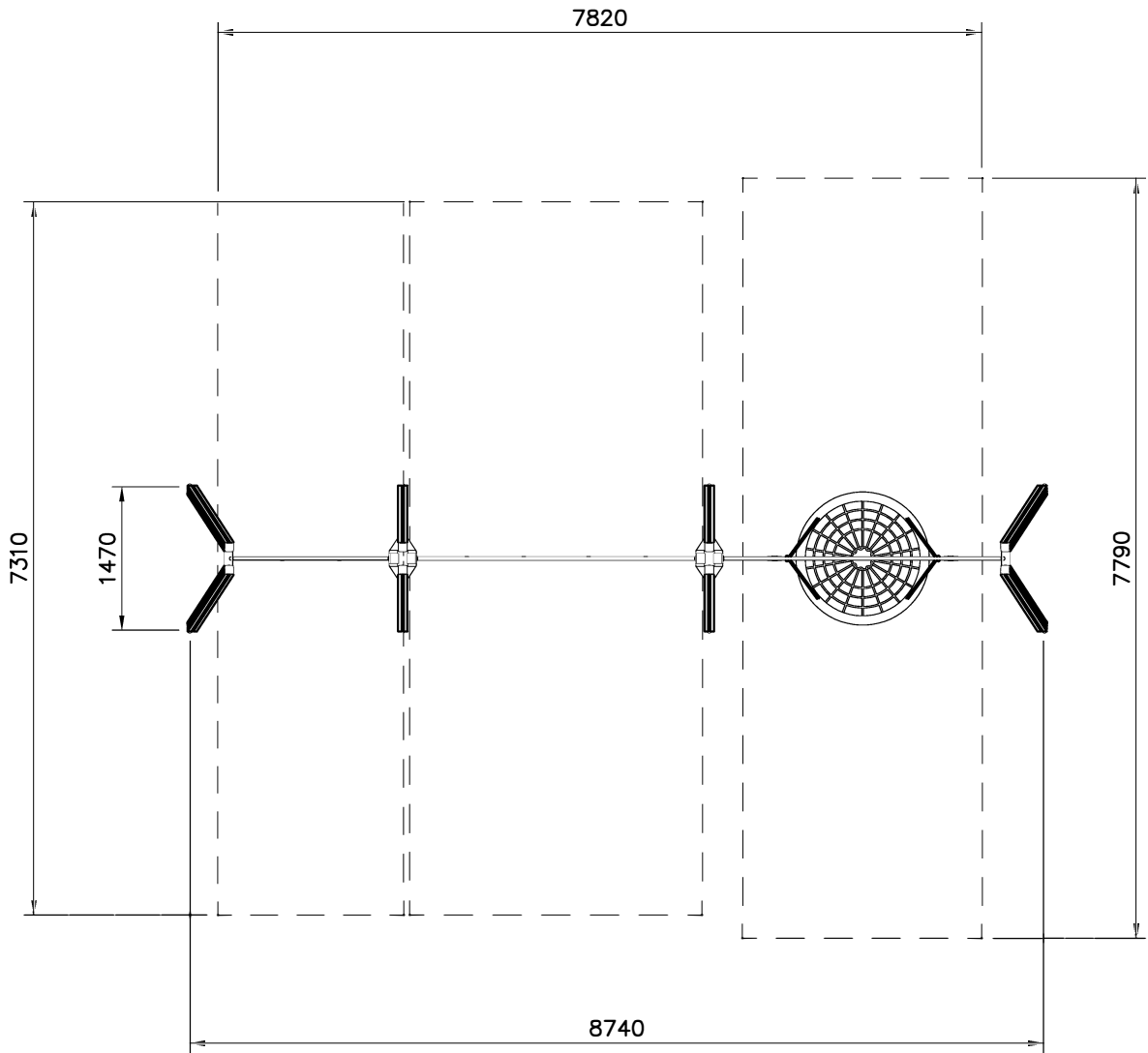
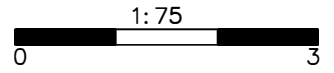

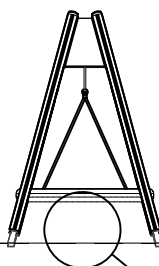
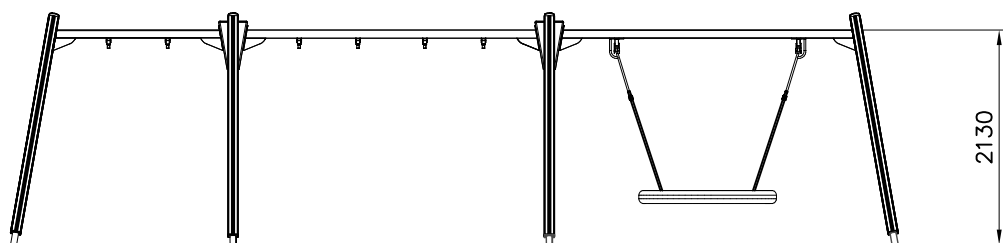

DET 5

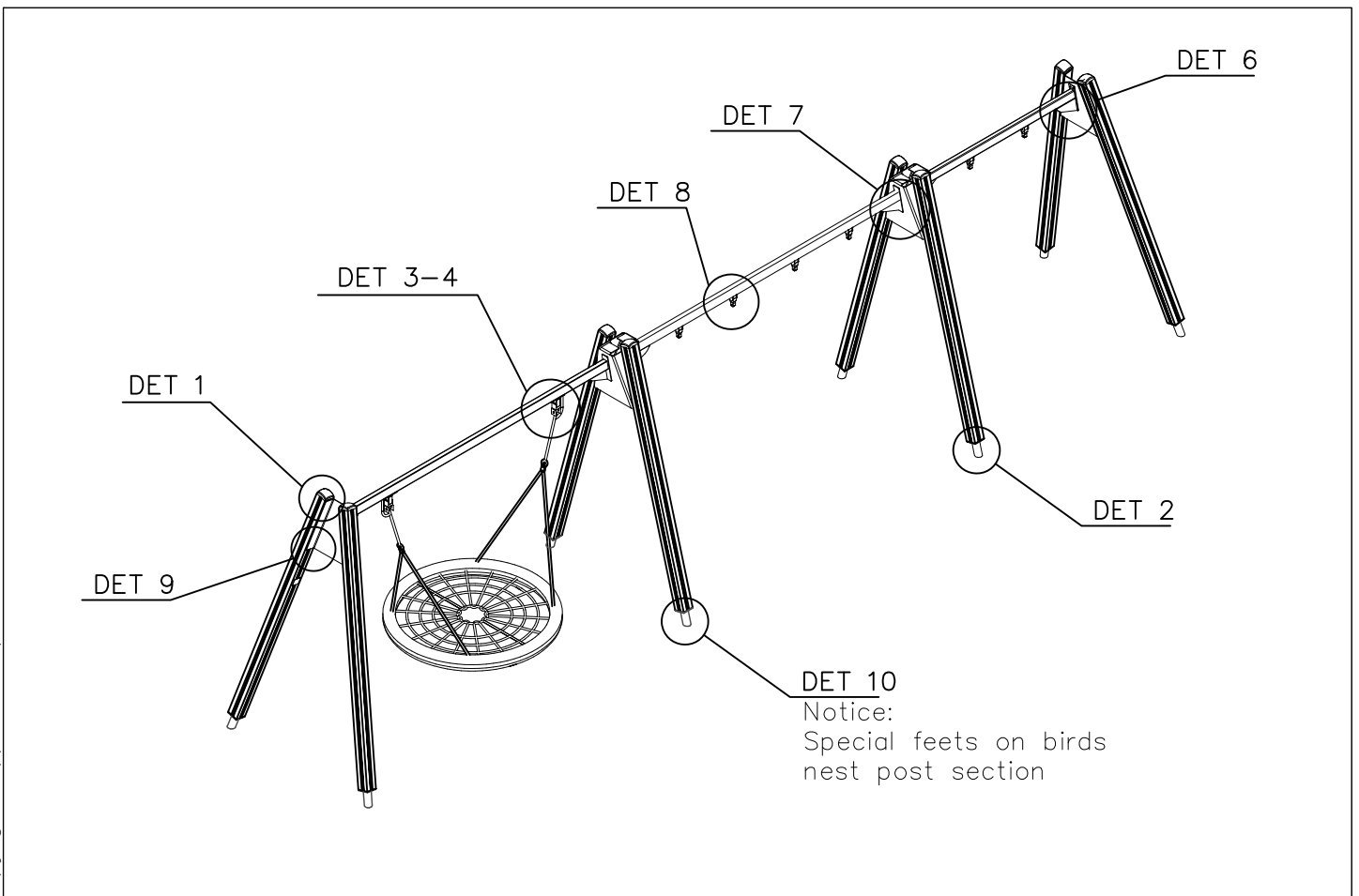
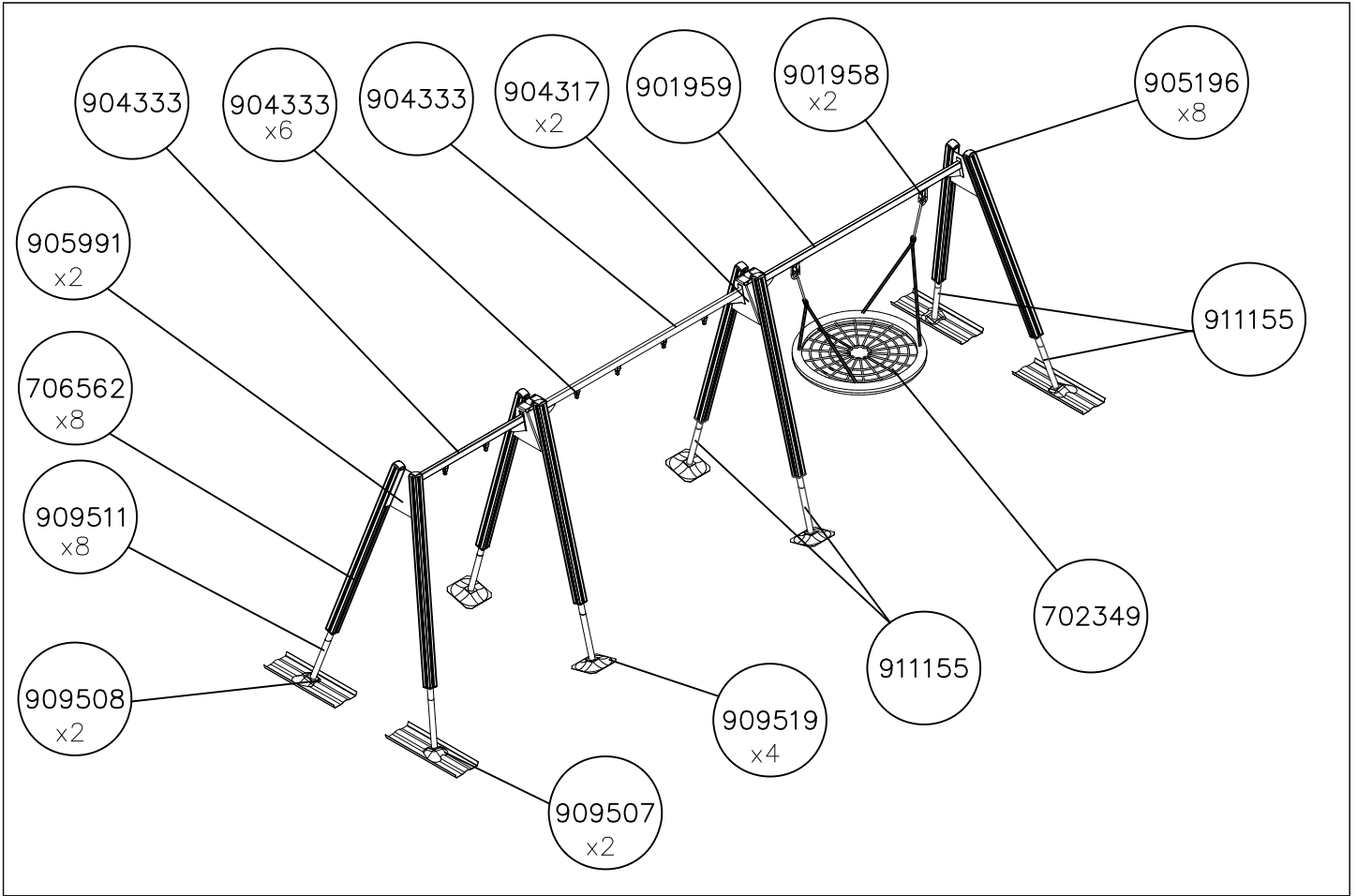

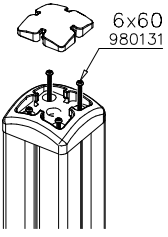
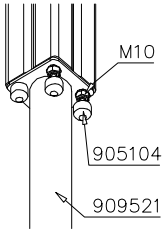
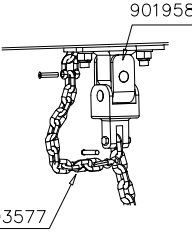
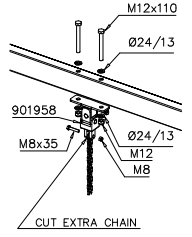
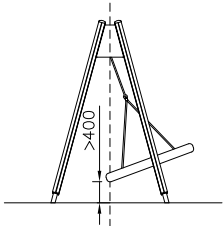
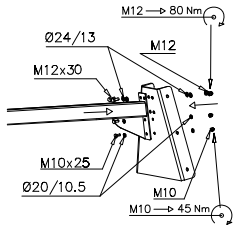
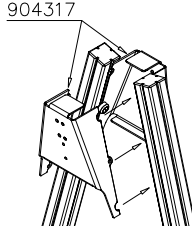
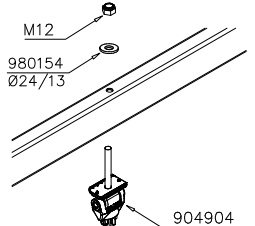
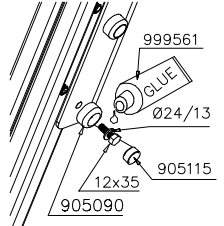
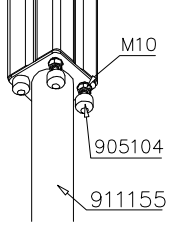
<p>DET 1</p>  <p>6x60 980131</p>	<p>DET 2</p>  <p>M10 905104 909521</p>	<p>DET 3</p>  <p>901958 903577</p>	<p>DET 4</p>  <p>M12x110 Ø24/13 901958 M8x35 Ø24/13 M12 M8 CUT EXTRA CHAIN</p>
<p>DET 5</p>  <p>>400</p>	<p>DET 6</p>  <p>M12 → 80 Nm Ø24/13 M12 M12x30 M10x25 Ø20/10.5 M10 M10 → 45 Nm</p>	<p>DET 7</p>  <p>904317</p>	<p>DET 8</p>  <p>M12 980154 Ø24/13 904904</p>
<p>DET 9</p>  <p>999561 GLUE Ø24/13 12x35 905115 905090</p>	<p>DET 10</p>  <p>M10 905104 911155</p>		



		
<p>$h < 600$</p> <p>Without movement and therefore without Impact Area</p>	<p>Totally hard surfaces.</p> <p>Note. Lappset does <u>not recommend</u> totally hard surfaces at all.</p>	<p>E.g. concrete or asphalt</p> 
<p>$h < 600$</p> <p>With movement e.g. rocking</p>	<p>Materials with very limited impact attenuating properties.</p>	<p>E.g. wood</p> 
<p>$h < 1000$</p>	<p>Materials with significant impact attenuating properties.</p>	<p>fine gravel 0–8 mm</p>  <p>grass</p>  <p>unsorted sand</p> 
<p>$h < 3000$</p>	<p>Loose fill material</p> <p>E.g. sand/gravel 0,25...8 mm D60/D10<3,0 Woodchips 5...30 mm bark 20...80 mm</p>	 <p>\underline{S} \underline{h}</p> <p>30 cm < 2,0 m</p> <p>40 cm < 3,0 m</p>
	<p>Syntethic granulates</p> <p>\underline{S} \underline{h}</p> <p>40 mm ~> 1,2...1,3 m</p> <p>50 mm ~> 1,5...1,7 m</p> <p>60 mm ~> 1,8...2,0 m</p> <p>70 mm ~> 2,1...2,5 m</p> <p>Note. For accurate values, see manufacturer's instructions.</p>	

REMOVE SAFETY SURFACE/SAND/GRAVEL
TO CHECK FOUNDATION



REMOVE SAFETY SURFACE/SAND/GRAVEL
TO CHECK FOUNDATION



DET A

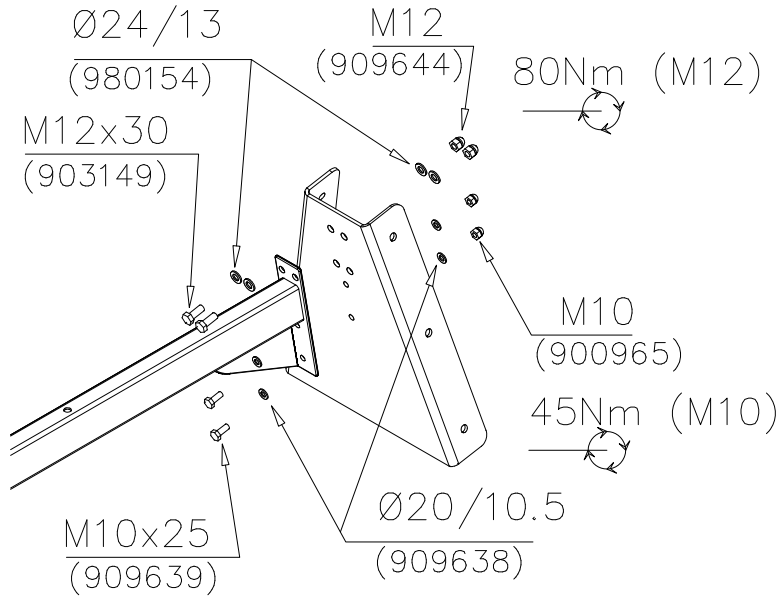

-  M12x30 2 pcs
-  Ø24/13 4 pcs
-  M12 2 pcs
-  M10x25 2 pcs
-  Ø20/10.5 4 pcs
-  M10 2 pcs
-  905991 1 pcs

DET A1

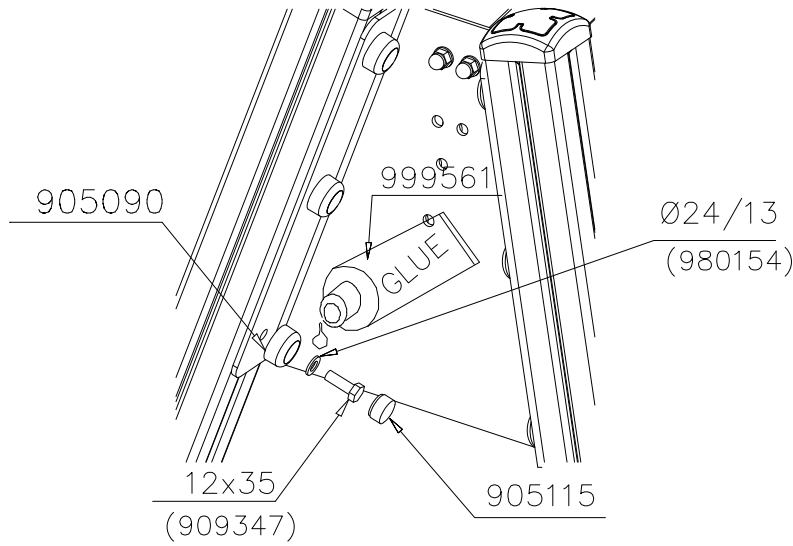

-  M12x35 6 pcs
-  Ø24/13 6 pcs
-  Ø45 6 pcs
-  Ø30 6 pcs
-  GLUE

DET B

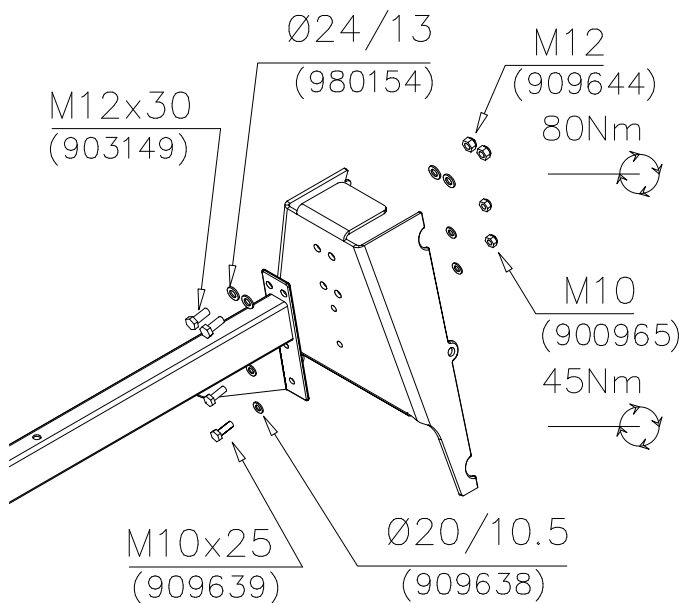

-  M12x30 2 pcs
-  Ø24/13 4 pcs
-  M12 2 pcs
-  M10x25 2 pcs
-  Ø20/10.5 4 pcs
-  M10 2 pcs

DET B

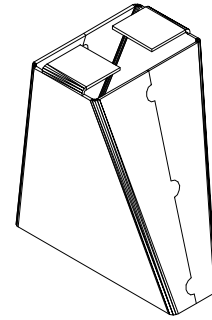
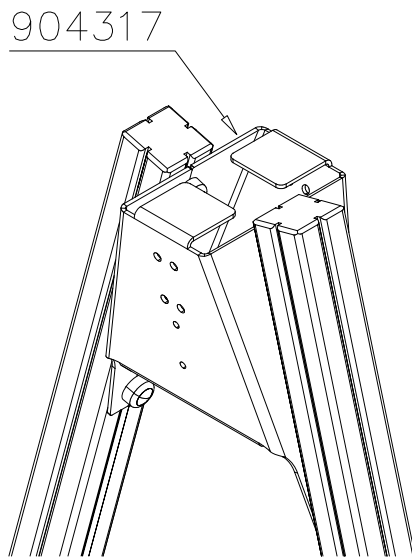

904317

DET B1

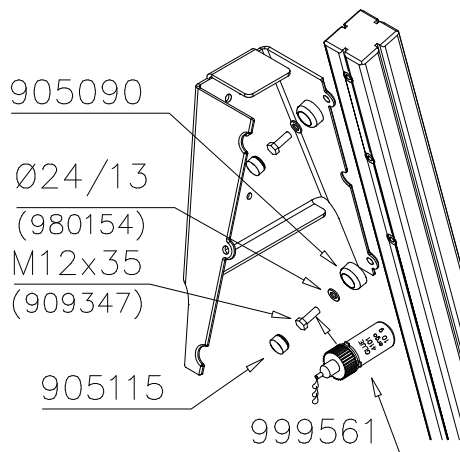

M12x35 6 pcs



Ø24/13 6 pcs

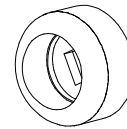

Ø45 6 pcs

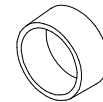

Ø30 6 pcs



GLUE

DET C

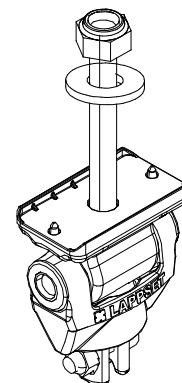
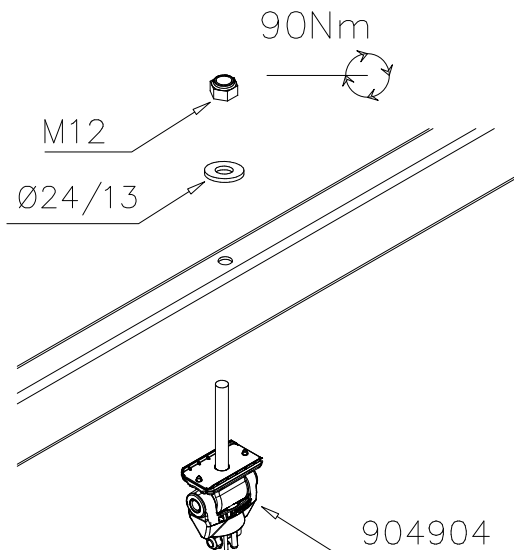

904904

DET D

90Nm

M12x110 (906499)

Ø24/13 (980154)

901958

M8x35

M12 (902234)

M8

CUT EXTRA CHAIN

M12x110 2 pcs

Ø24/13 4 pcs

M12 2 pcs

901958 1 pcs

DET D

903577

903577 1 pcs

DET E

6x60 980131

980131 4 pcs

905138 1 pcs

905196 1 pcs

REF: SWING
DATE: 29.6.2022

DET F

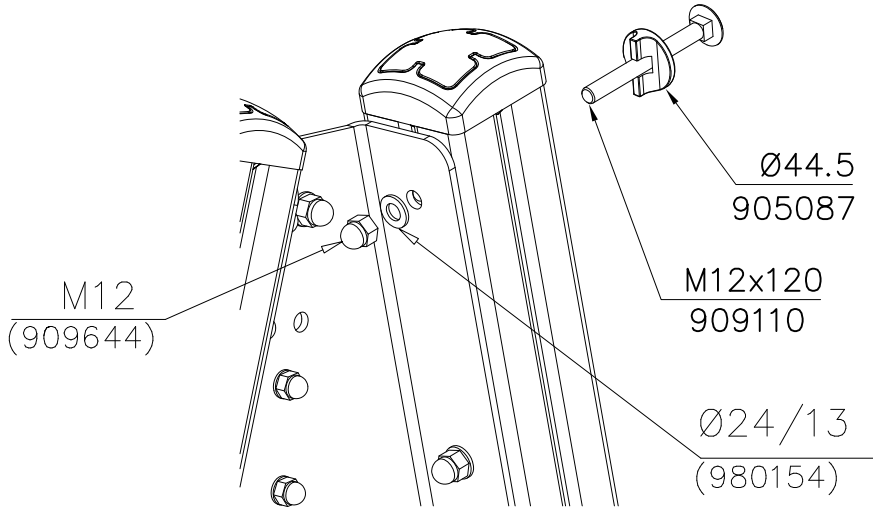

DET G



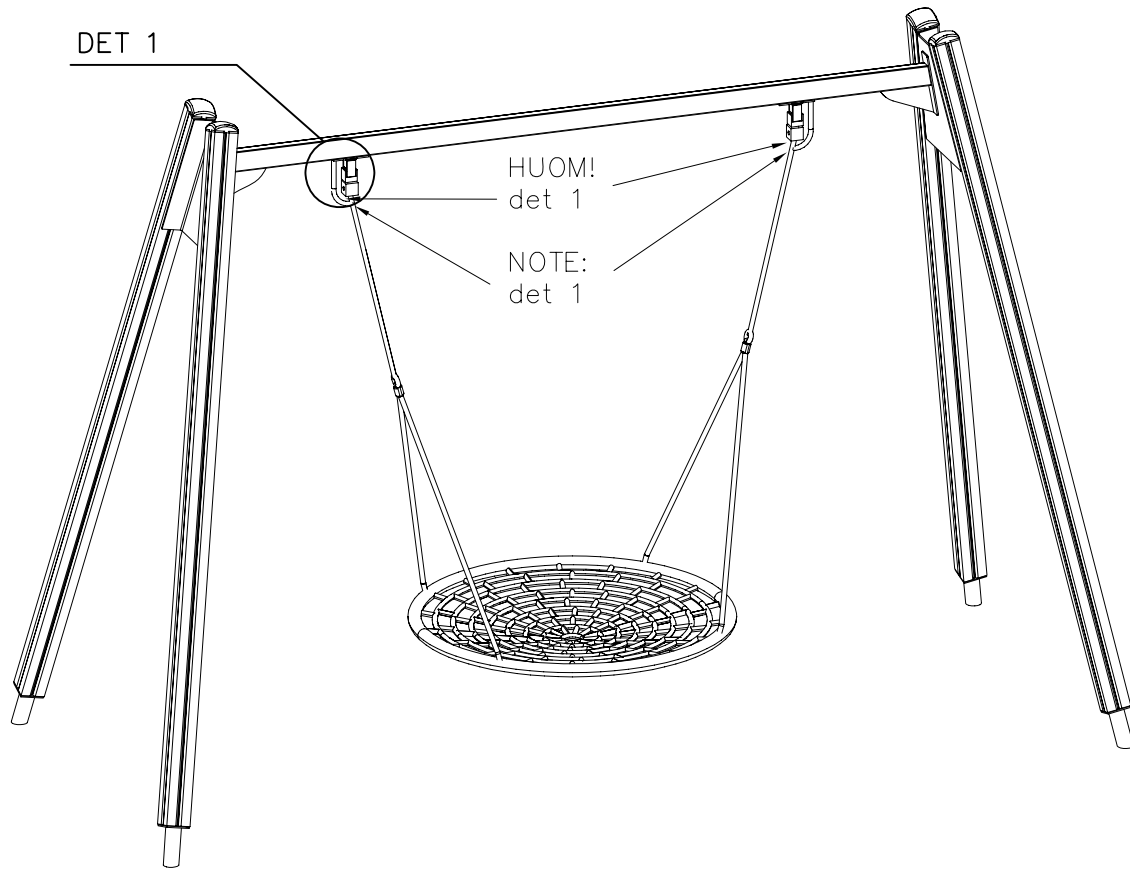

DET 1

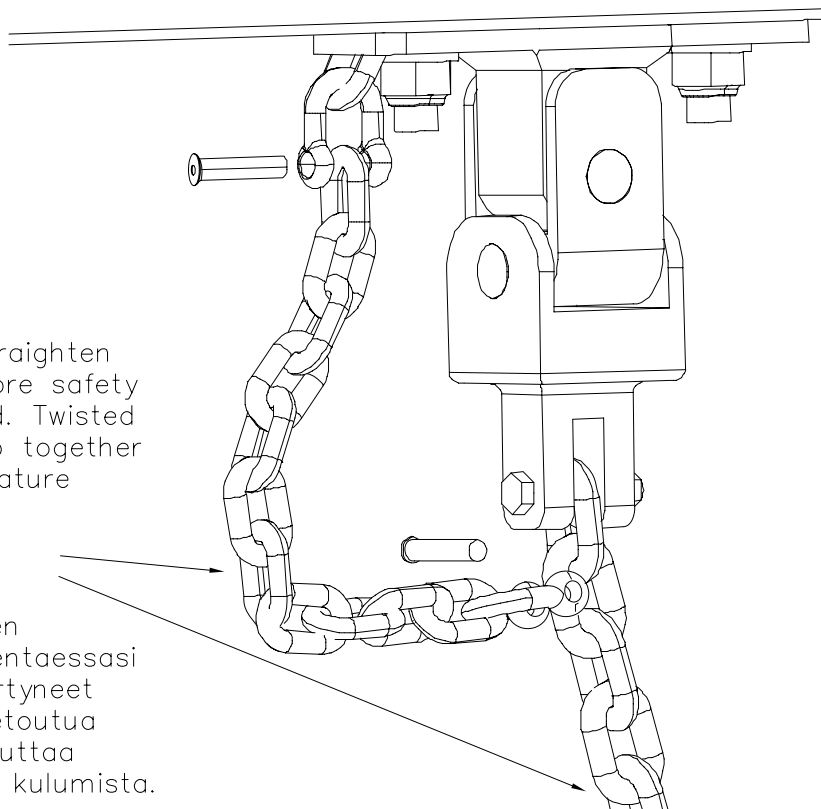

LAPPSET®
BETON FOUNDATION

FOOT

DATE: 27.10.2015

1(1)

② 905104	PCS		PCS
	4		
 M10	PCS		PCS



905104

**Tuotekyltti tulee tuotteen mukana yhdellä seuraavista tavoista:****1) Metallinen tuotekyltti ja kiinnitysruuvit**

- Kiinnitä tuotekyltti ruuveilla tolppaan noin 2 metrin korkeuteen kuvan 1 mukaisesti.

2) Tuotekylttitarra

- Puhdista maalattu metalli- tai vaneripinta pölystä ja kosteudesta. Liimaa tarra kuvan 2 mukaisesti.
- Huom. Älä kiinnitä tarraa karheapintaiseen laminaattiin tai maalattuun puuhun.

Vår produktmärkning levereras på ett av följande sätt:**1) Produktskylt i metall**

- Fäst skylten med de medföljande skruvarna

2) Självhäftande produktetikett

- Rengör den pulverlackerade metallytan eller laminatyten så att den blir fri från smuts och fukt. Fäst etiketten enligt fig. 2.
- Obs! Fäst ej etiketten på detaljer med skrovlig yta eller på målat trä.

Product label is delivered by one of following ways:**1) Metal product label and screws**

- Fasten the label with screws.

2) Label sticker

- Clean the painted metal or plywood surface from dirt and moisture. Fasten the sticker as shown in the figure 2.
- Note. Do not attach the sticker to rough surfaced laminate or painted wood.

La plaque d'informations produit est livrée sous l'une de ces 3 formes :**1) Plaque métallique et vis**

- Fixez la plaque à l'aide des vis.

2) Etiquette autocollante

- Avant de coller l'étiquette, nettoyez le composant métallique peint ou la plaque de contreplaqué, de toute saleté. La surface doit être sèche (voir image 2).
- Attention, ne pas coller l'étiquette sur une surface lamellé-collée irrégulière ou sur du bois peint.

Die Auslieferung des Produktaufklebers erfolgt auf eine dieser Arten:**1) Produkt-Schild aus Metall incl. Schrauben**

- Die Befestigung des Schildes erfolgt mittels der Schrauben.

2) Aufkleber

- Entfernen Sie zunächst Schmutz und Feuchtigkeit vom lackierten Metall bzw. von der Holzoberfläche und bringen Sie den Aufkleber wie im Bild oben rechts beschrieben auf den gesäuberten Untergrund auf.
- Beachten Sie: Bringen Sie den Aufkleber nicht auf raues laminiertes oder lackiertes Holz an.