

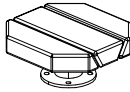

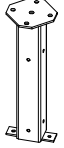

| | | | | | |
|---|--------|-----|---|--------|-----|
| ① | 009338 | PCS | ② | 903107 | PCS |
|  | | 1 |  | | 1 |
| | | | L 602 | | |
| ③ | 909347 | PCS | ④ | 909248 | PCS |
|  | | 4 |  | | 4 |
| M12x35 | | | M12 | | |
| ⑤ | 980154 | PCS | ⑥ | 702341 | PCS |
|  | | 8 |  | | 1 |
| Ø24/13 | | | 90x50 | | |
| | PCS | | | PCS | |
| | | | | | |
| | PCS | | | PCS | |
| | | | | | |
| | PCS | | | PCS | |
| | | | | | |
| | PCS | | | PCS | |
| | | | | | |



Falling Space Area 9.5 m²
Max falling height 180 mm.

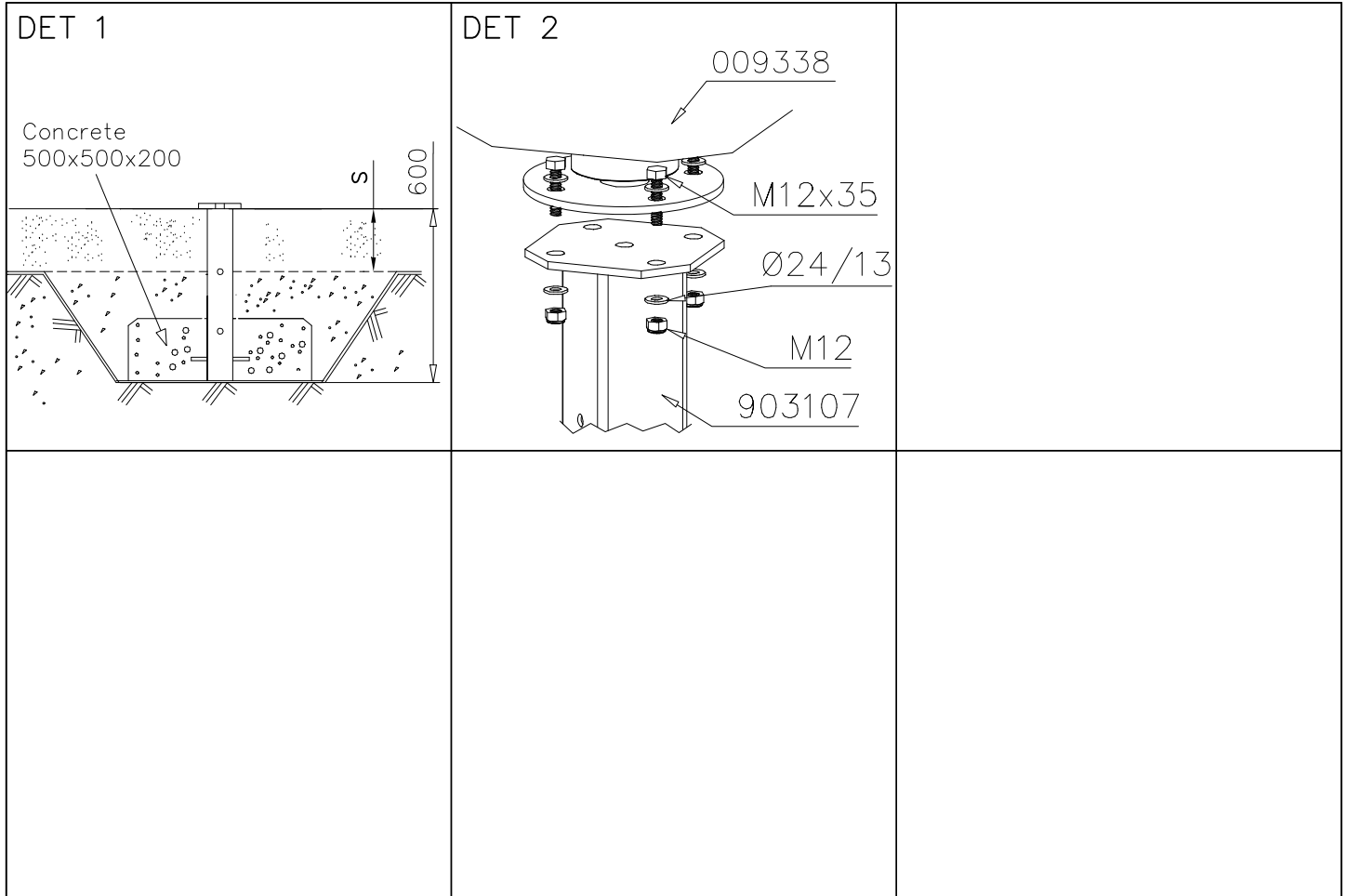