

LAPPSET®







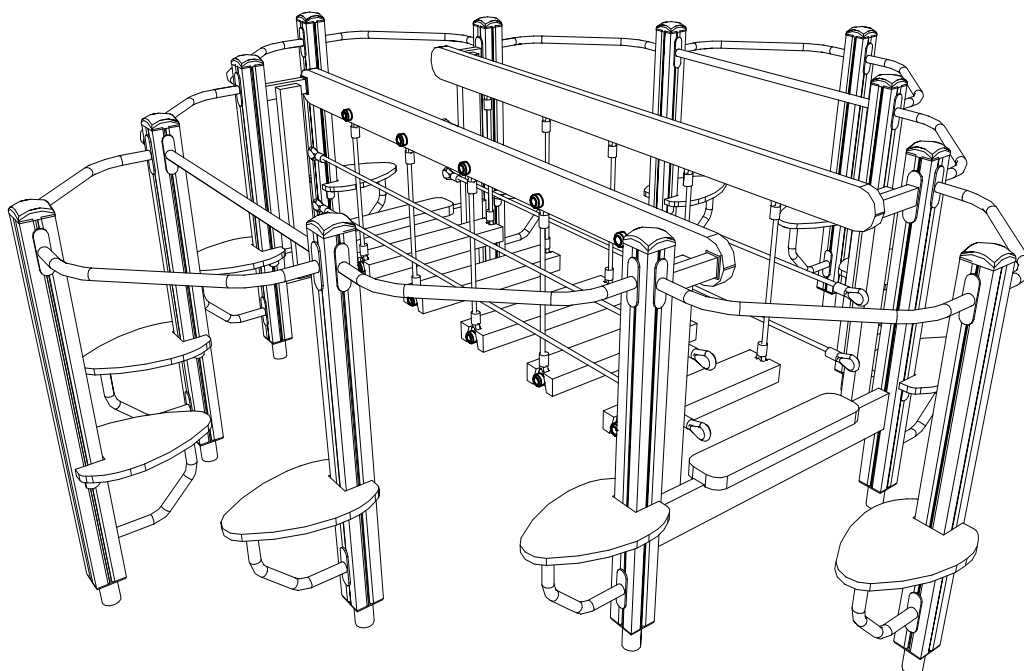

FINNO

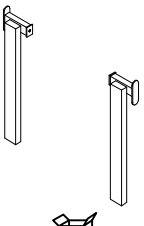
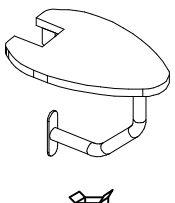
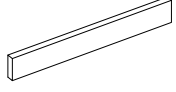
ASENNUSOHJE
MONTERINGSANSVISNING
INSTALLATION INSTRUCTION
AUFBAUANLEITUNG
NOTICE D'INSTALLATION

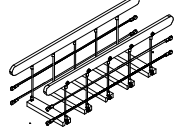
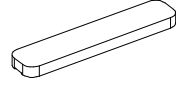
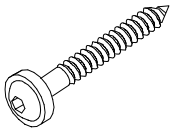
REF: 120031
DATE: 1.4.2005

120031

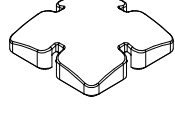
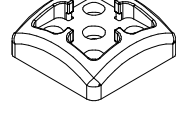
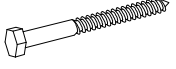
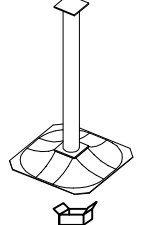
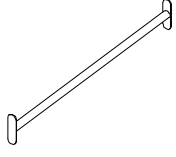
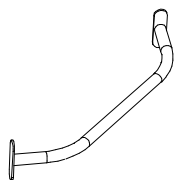

003122	PCS 2	003990	PCS 12	005692	PCS 2	006812	PCS 12	007127	PCS 1	007333	PCS 2
											
				L 1104		L 1250					
900240	PCS 56	905051	PCS 8	905104	PCS 48	905120	PCS 24	905138	PCS 12	905196	PCS 12
											
8x70		Ø24/8.4		M10		Ø14		GREY		GREY	
909238	PCS 8	909521	PCS 12	909542	PCS 2	909893	PCS 12	980131	PCS 48		PCS
											
8x90				L 1104				6x60			
	PCS		PCS		PCS		PCS		PCS		PCS
	PCS		PCS		PCS		PCS		PCS		PCS
	PCS		PCS		PCS		PCS		PCS		PCS

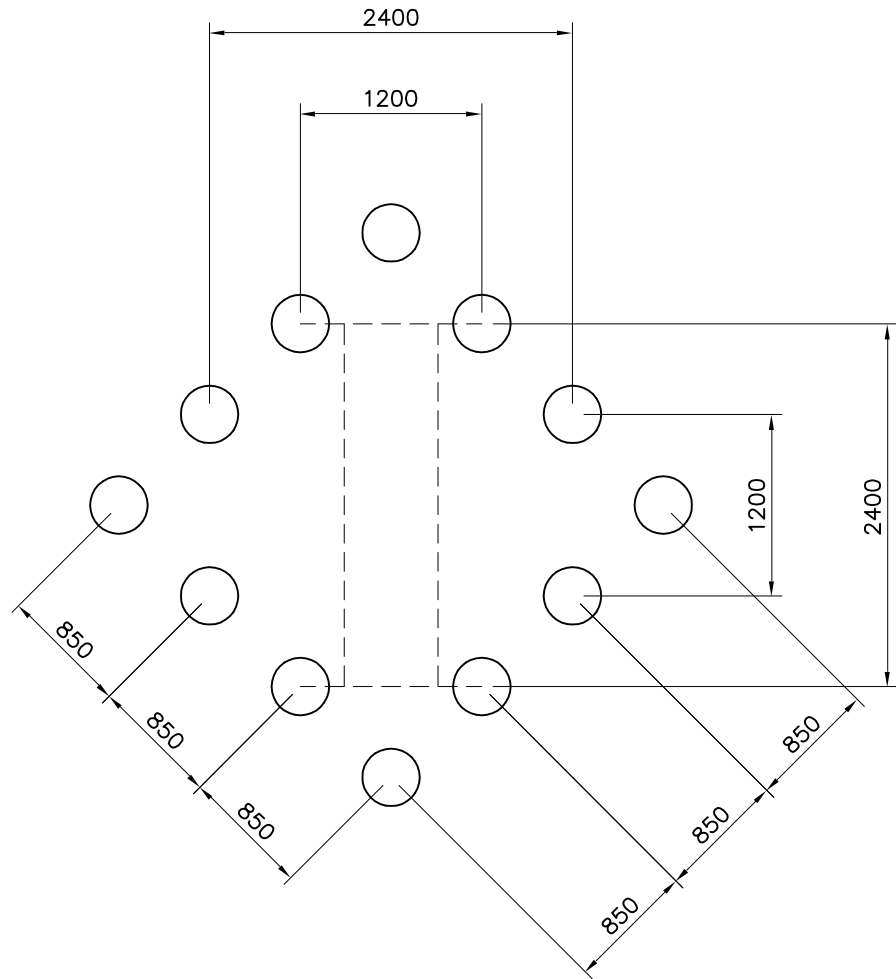
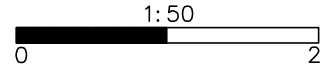

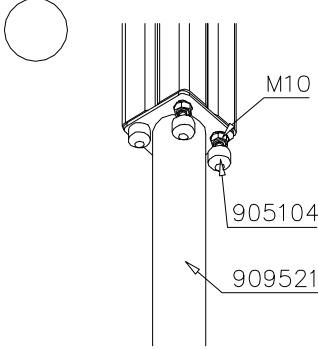
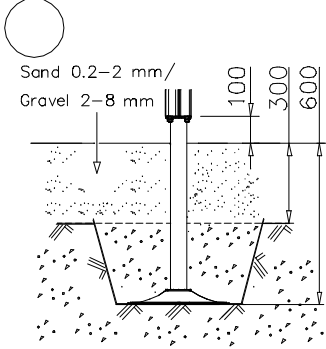
 <p>M10 905104 909521</p>	 <p>Sand 0.2-2 mm/ Gravel 2-8 mm</p> <p>100 300 600</p>	

EN Impact Area 31.9 m²

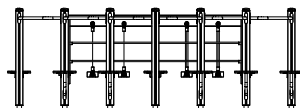
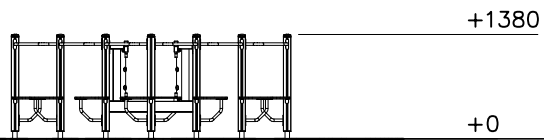
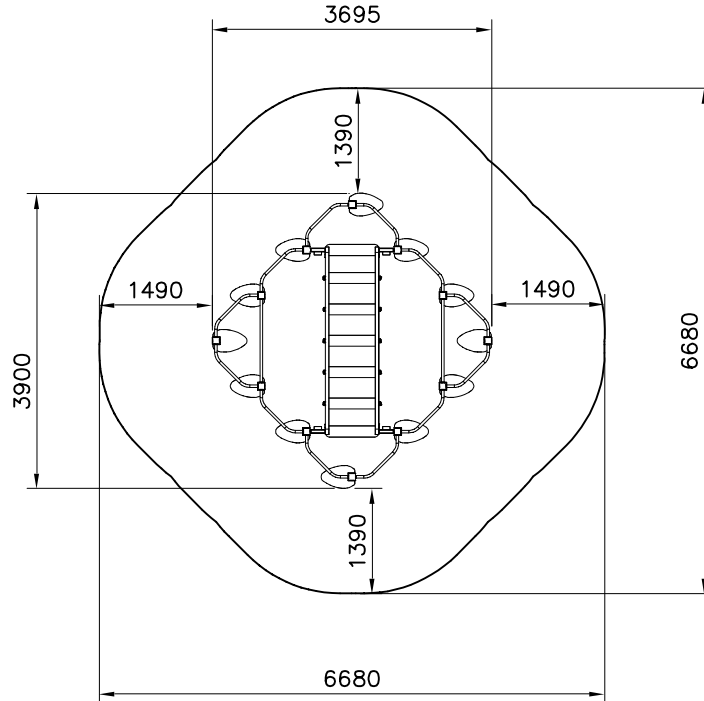
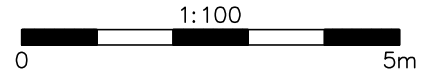

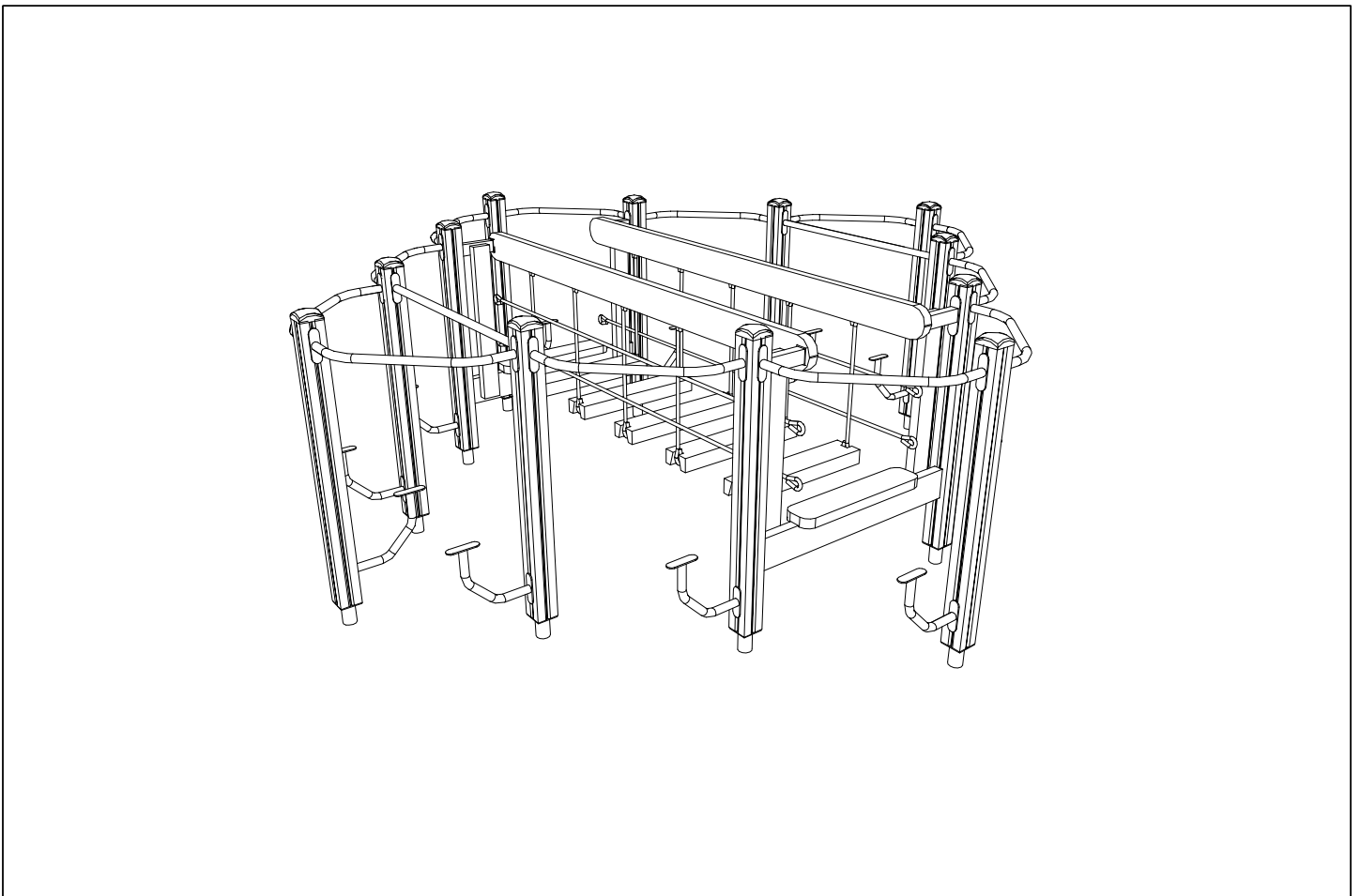
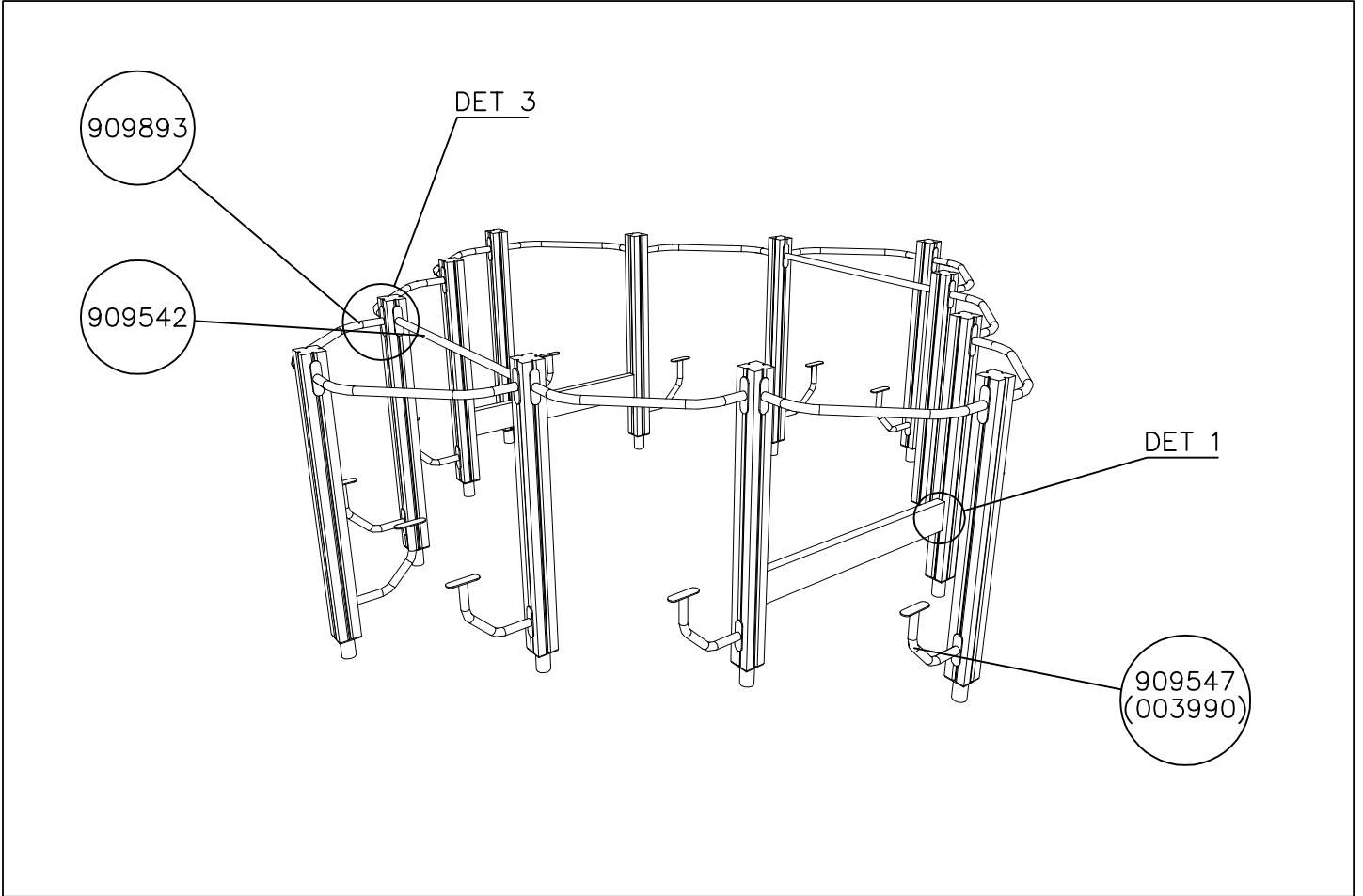

DET 1	DET 2	DET 3	DET 4
