

LAPPSET®









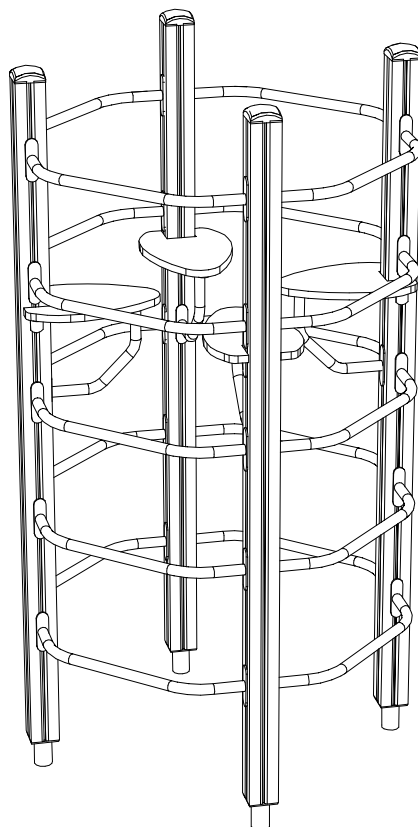

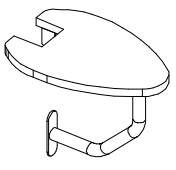
FINNO

ASENNUSOHJE
MONTERINGSANSVISNING
INSTALLATION INSTRUCTION
AUFBAUANLEITUNG
NOTICE D'INSTALLATION

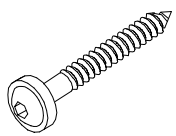
REF: 120282
DATE: 1.4.2005

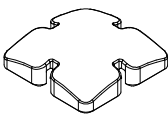
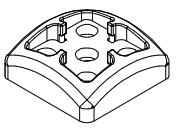
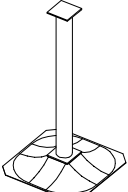
120282

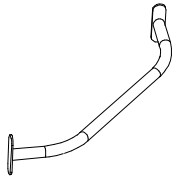

003990  4 	PCS 4	006822  L 2250 4 	PCS 4	900240  8x70 80	PCS 80	905104  M10 16	PCS 16	905120  Ø14 8	PCS 8	905138  GREY 4	PCS 4
905196  GREY 4	PCS 4	909521  4 	PCS 4	909893  20	PCS 20	980131  6x60 16	PCS 16		PCS		PCS
	PCS		PCS		PCS		PCS		PCS		PCS
	PCS		PCS		PCS		PCS		PCS		PCS
	PCS		PCS		PCS		PCS		PCS		PCS
	PCS		PCS		PCS		PCS		PCS		PCS
	PCS		PCS		PCS		PCS		PCS		PCS

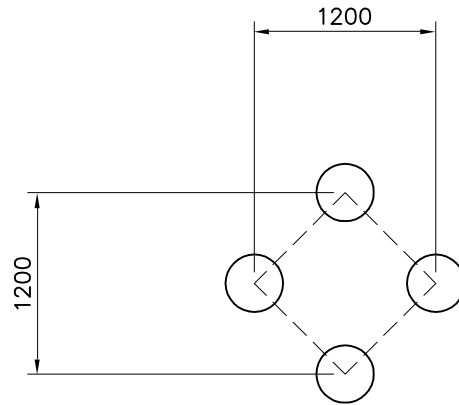
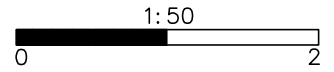

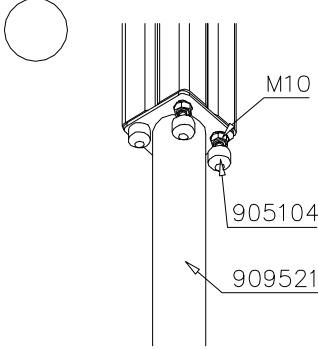
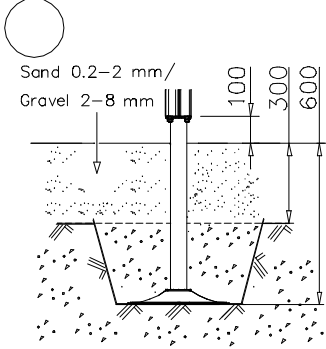
 <p>M10 905104 909521</p>	 <p>Sand 0.2-2 mm/ Gravel 2-8 mm</p> <p>100 300 600</p>	

EN Impact Area 20.6 m²

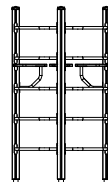
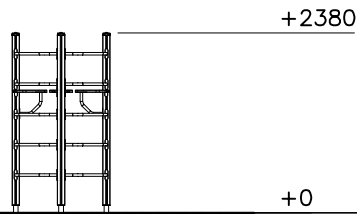
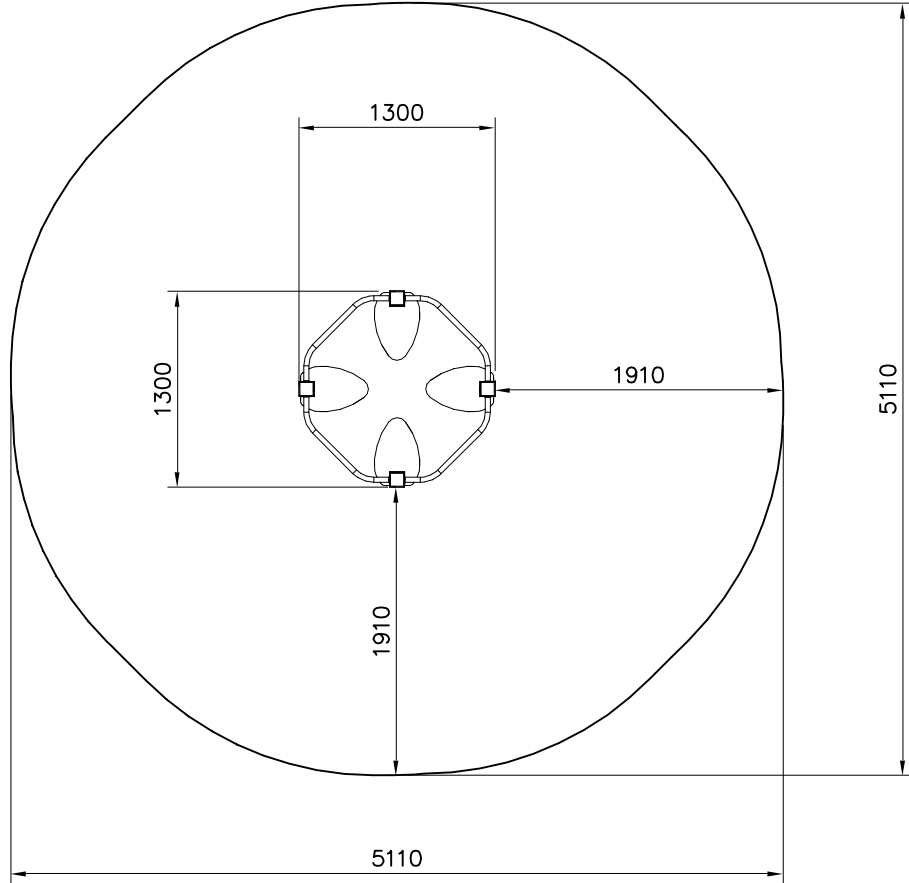
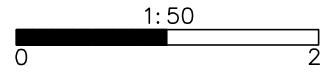

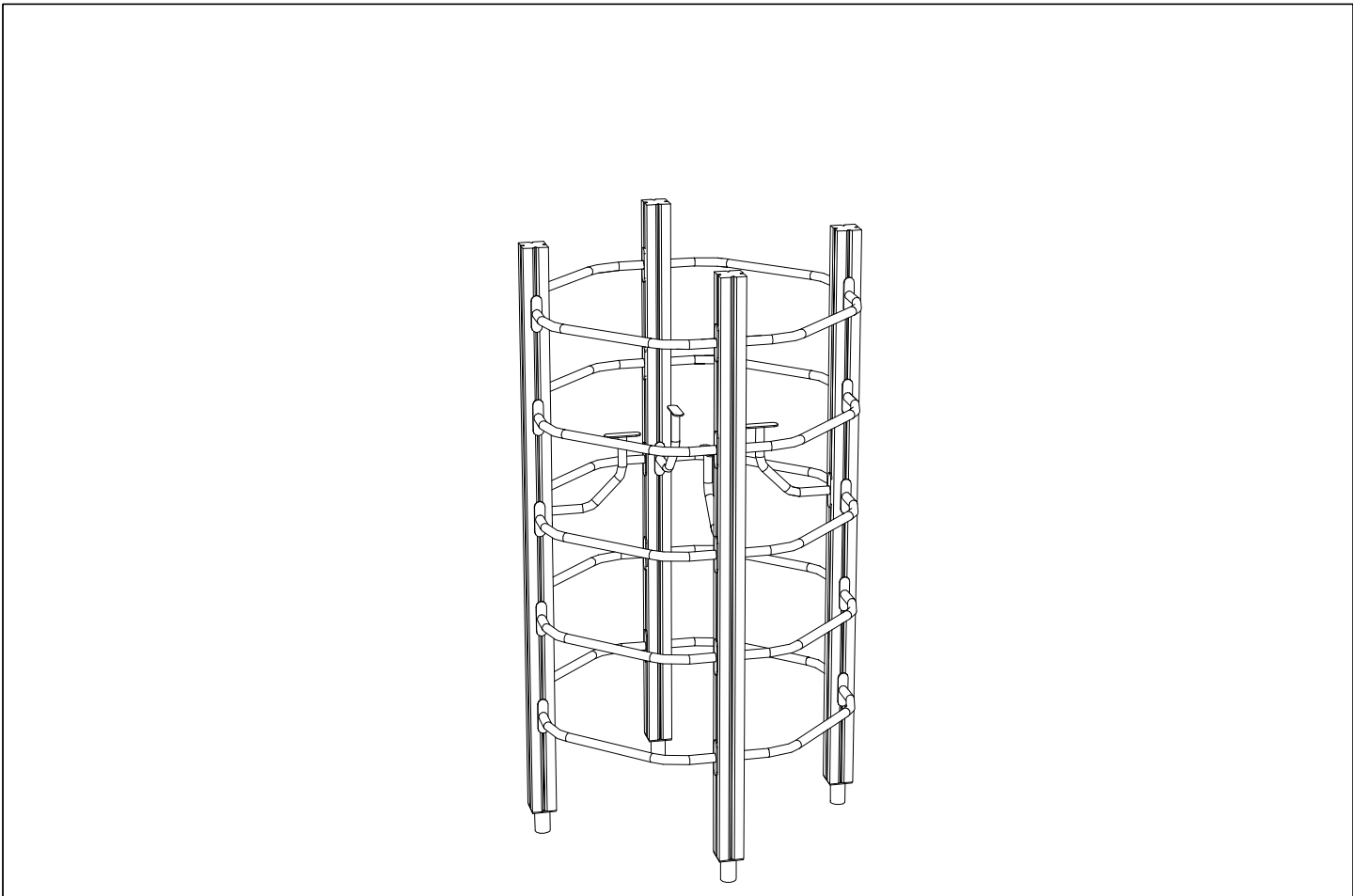
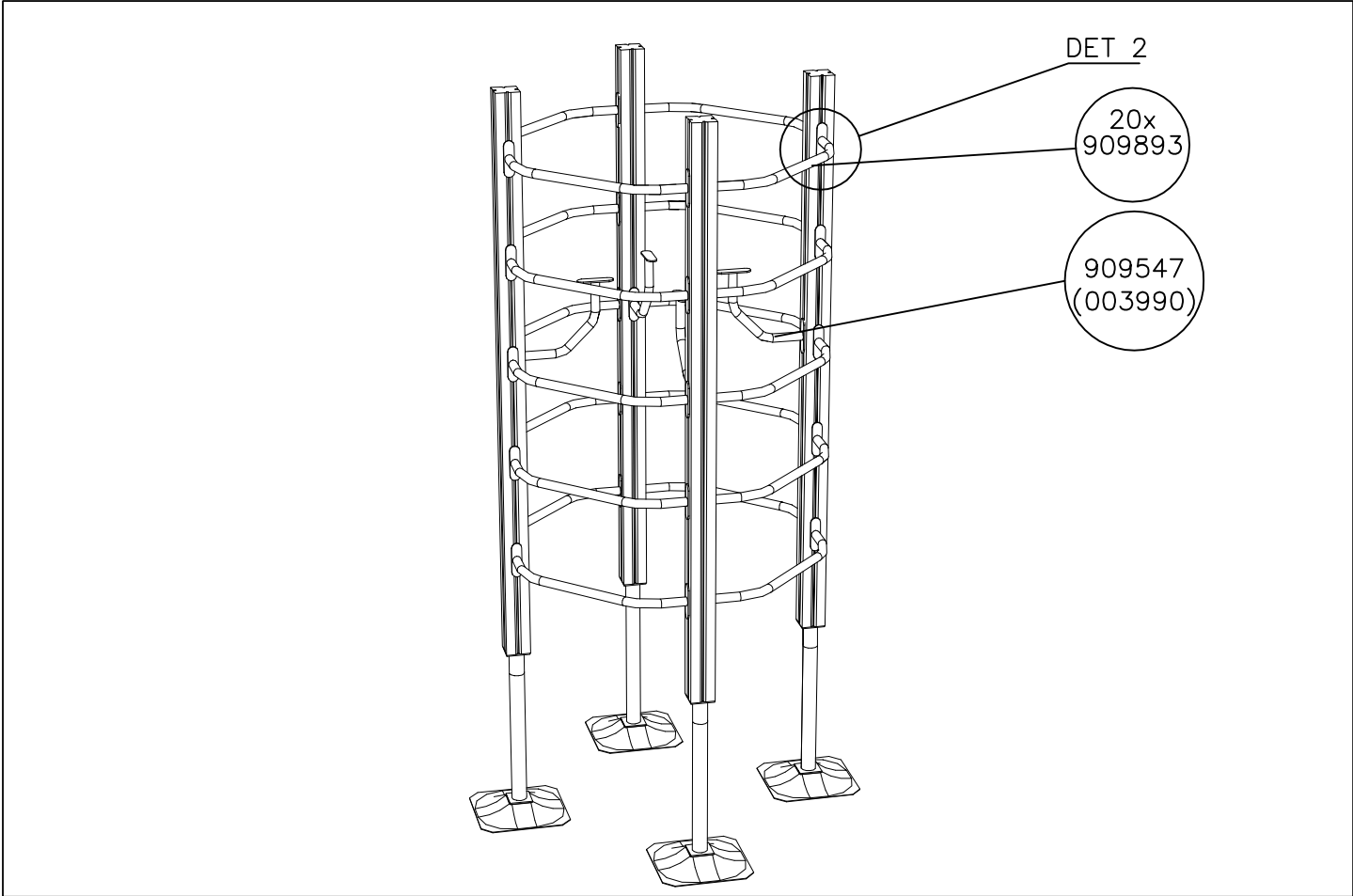

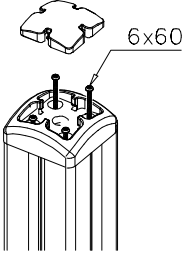
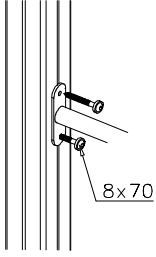
DET 1 	DET 2 	DET 3 