

# **LAPPSET®**









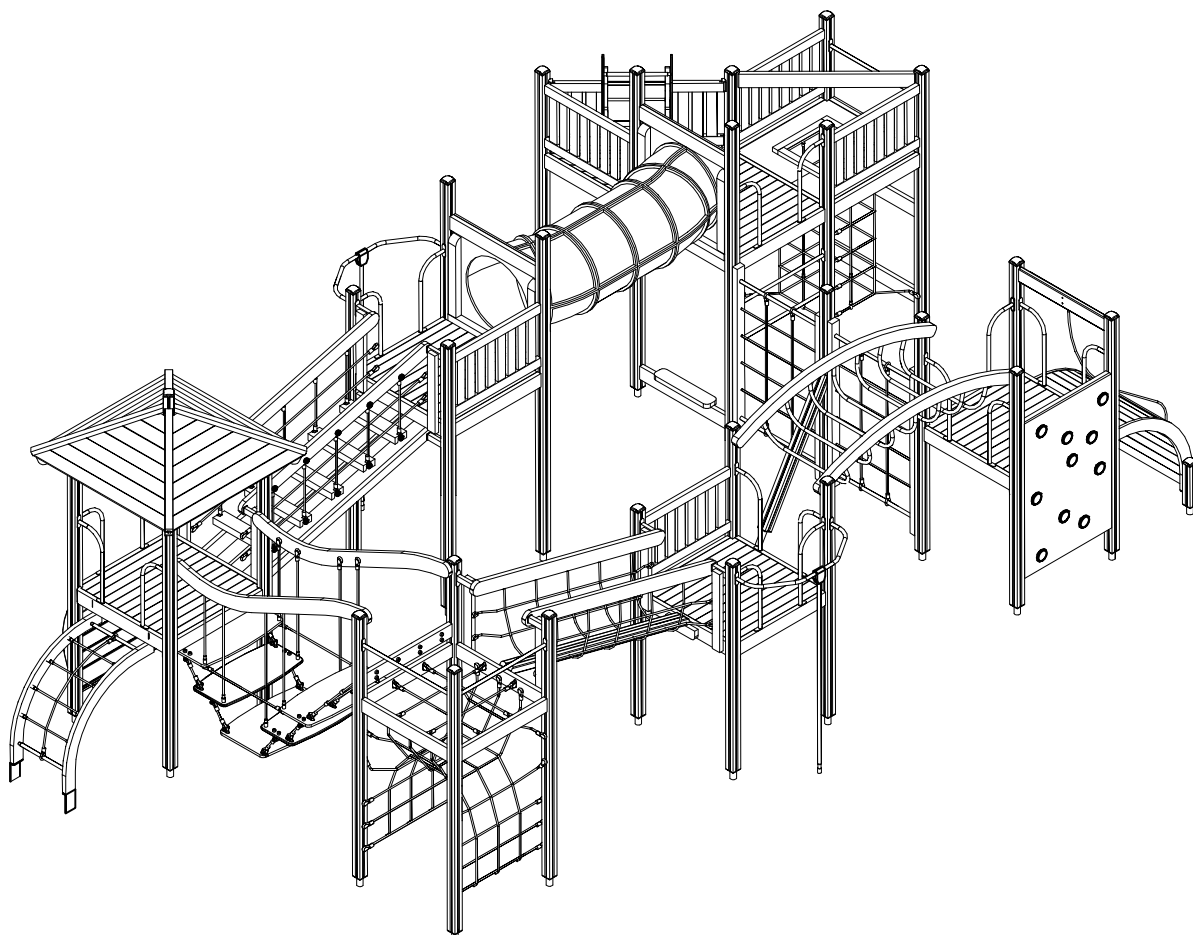

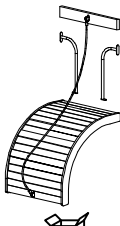
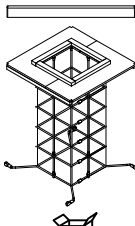
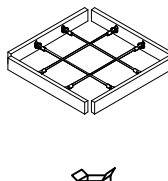
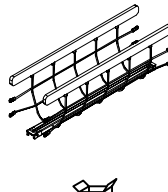
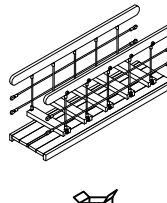
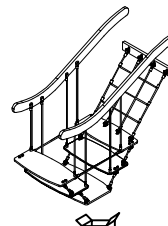
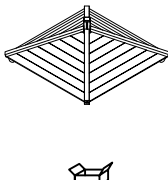
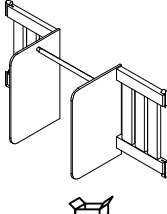
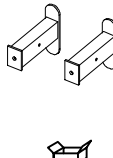
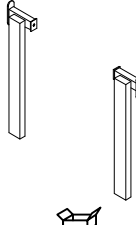
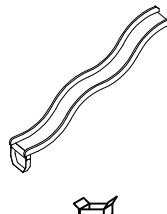
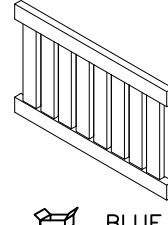
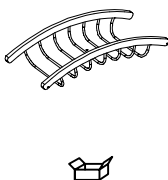
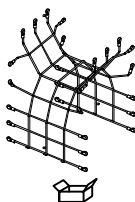
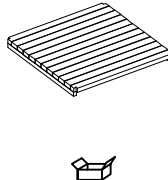
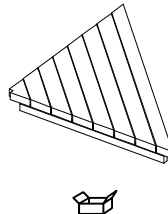
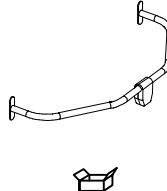
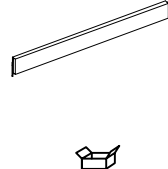
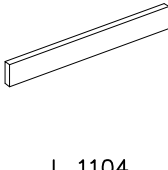
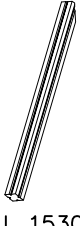
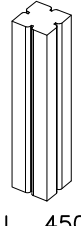

## **FINNO**

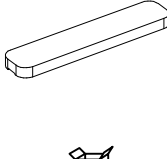
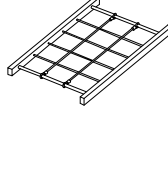
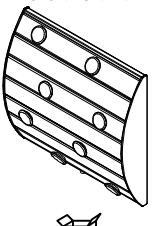
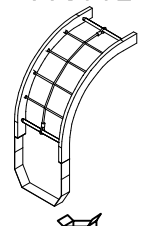
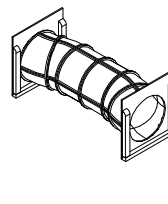
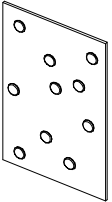
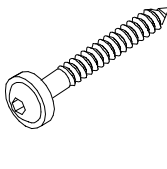



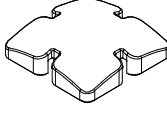
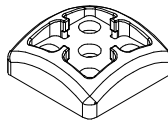

ASENNUSOHJE  
MONTERINGSANSVISNING  
INSTALLATION INSTRUCTION  
AUFBAUANLEITUNG  
NOTICE D'INSTALLATION

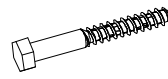
REF: 120301  
DATE: 1.4.2005

# **120301**

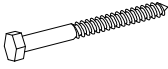
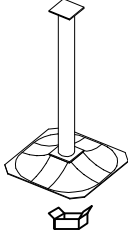
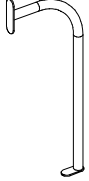
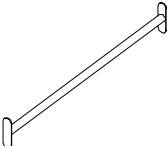

001818  1	PCS 1	001821  1	PCS 1	001823  1	PCS 1	001854  1	PCS 1	001855  1	PCS 1	001870  1	PCS 1
002799  1	PCS 1	003011  1	PCS 1	003120  3	PCS 3	003122  4	PCS 4	003613  1	PCS 1	003787  5 BLUE	PCS 5
003838  1	PCS 1	003850  1	PCS 1	003880  5	PCS 5	003886  1	PCS 1	005077  2	PCS 2	005610  1	PCS 1
005692  L 1104 31	PCS 31	006800  L 1530 1	PCS 1	006804  L 450 2	PCS 2	006822  L 2250 3	PCS 3	006825  L 2550 6	PCS 6	006828  L 2850 15	PCS 15
006834  L 3450 4	PCS 4	007333  1	PCS 1	007841  2	PCS 2	007974  1	PCS 1	008902  1	PCS 1	700229  1	PCS 1
700268  2	PCS 2	900240  8x70 65	PCS 65	905051  Ø24/8.5 126	PCS 126	905083  Ø32 24	PCS 24	905104  M10 124	PCS 124	905112  Ø22 24	PCS 24
905120  Ø14 60	PCS 60	905138  GREY 26	PCS 26	905196  GREY 26	PCS 26	907043  L 2690 1	PCS 1	907044  L 2090 1	PCS 1	909224  12x100 8	PCS 8

909231  8x130	PCS 1	909233  8x100	PCS 1	909235  8x60	PCS 24	909238  8x90	PCS 124	909521  909521	PCS 31	909540  909540	PCS 15
909542  L 1104	PCS 5	980131  6x60	PCS 104	980151  Ø16/8.4	PCS 24	980154  Ø24/13	PCS 8		PCS		PCS
	PCS		PCS		PCS		PCS		PCS		PCS
	PCS		PCS		PCS		PCS		PCS		PCS
	PCS		PCS		PCS		PCS		PCS		PCS
	PCS		PCS		PCS		PCS		PCS		PCS
	PCS		PCS		PCS		PCS		PCS		PCS

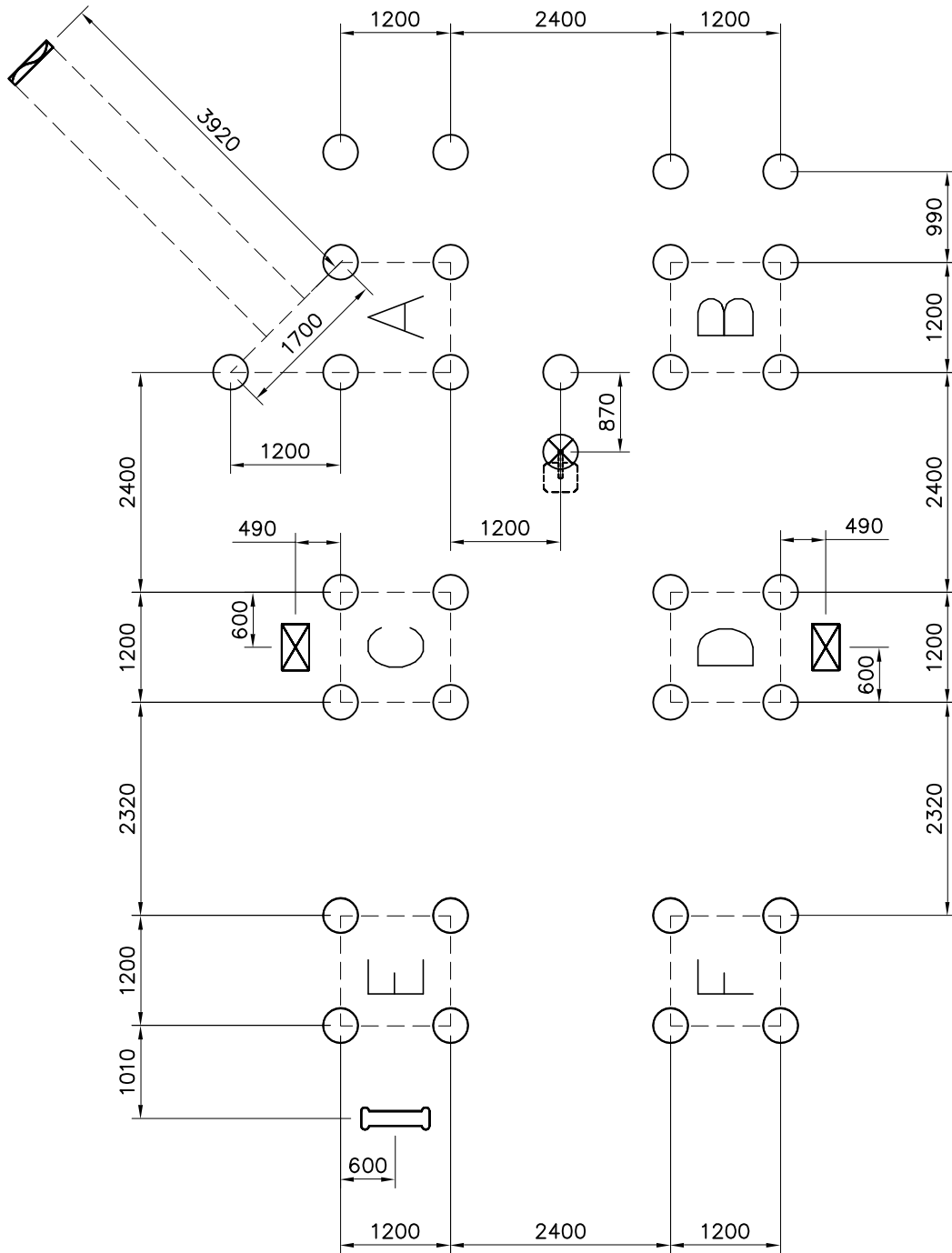
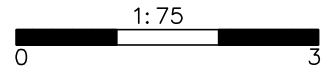

<p>M10          905104          909521</p>	<p>Sand 0.2–2 mm/          Gravel 2–8 mm</p> <p>100          300          600</p>	<p>Sand 0.2–2 mm/          Gravel 2–8 mm</p> <p>100          300          580</p>
<p>Sand 0.2–2 mm/          Gravel 2–8 mm</p> <p>300          400</p>	<p>Sand 0.2–2 mm/          Gravel 2–8 mm</p> <p>907040</p> <p>300          600</p>	<p>905104          909822</p>
<p>Sand 0.2–2 mm/          Gravel 2–8 mm</p> <p>210          300          400</p>		

EN Impact Area 135.2 m<sup>2</sup>

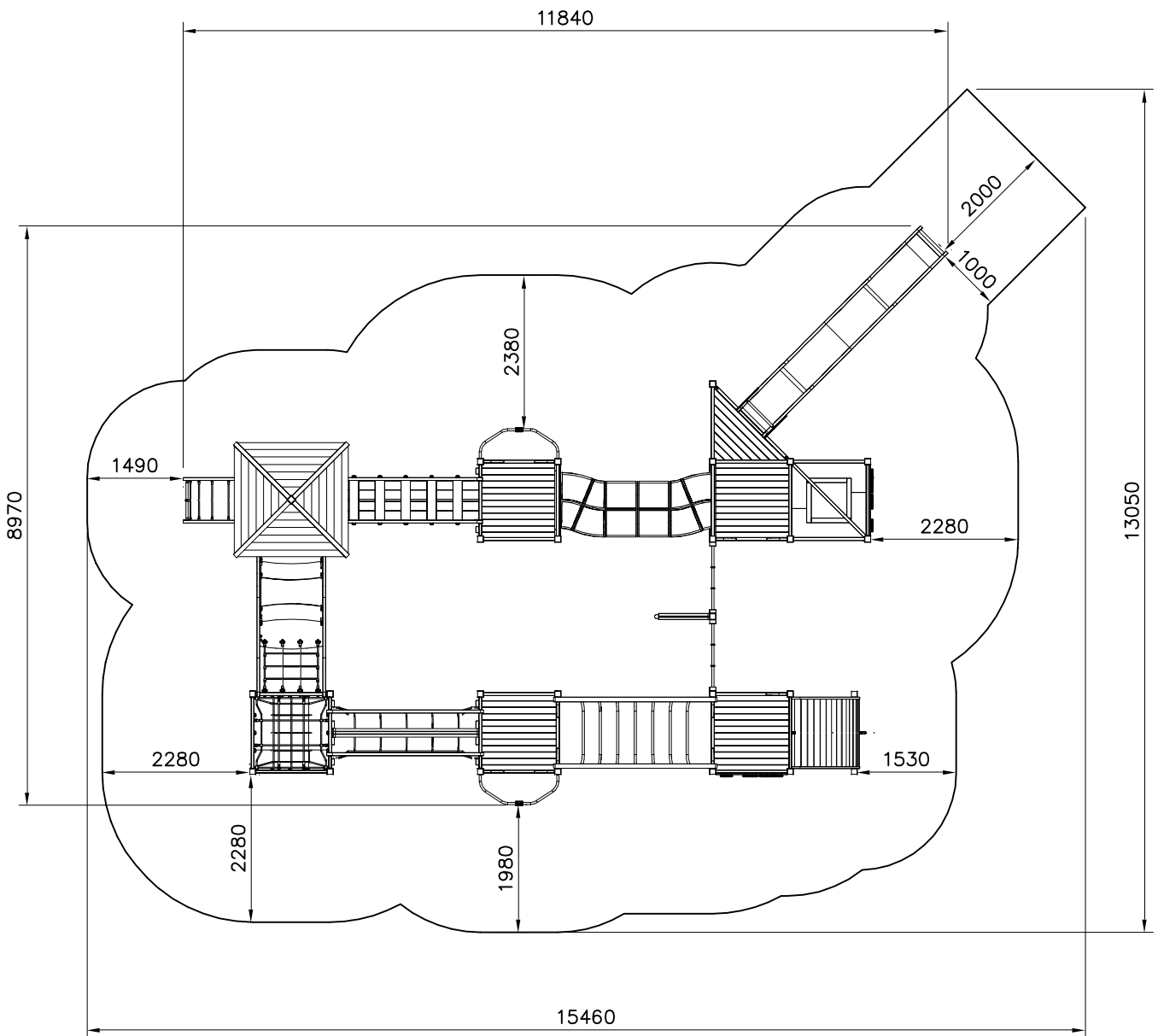
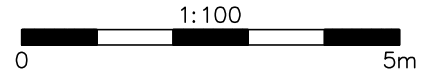

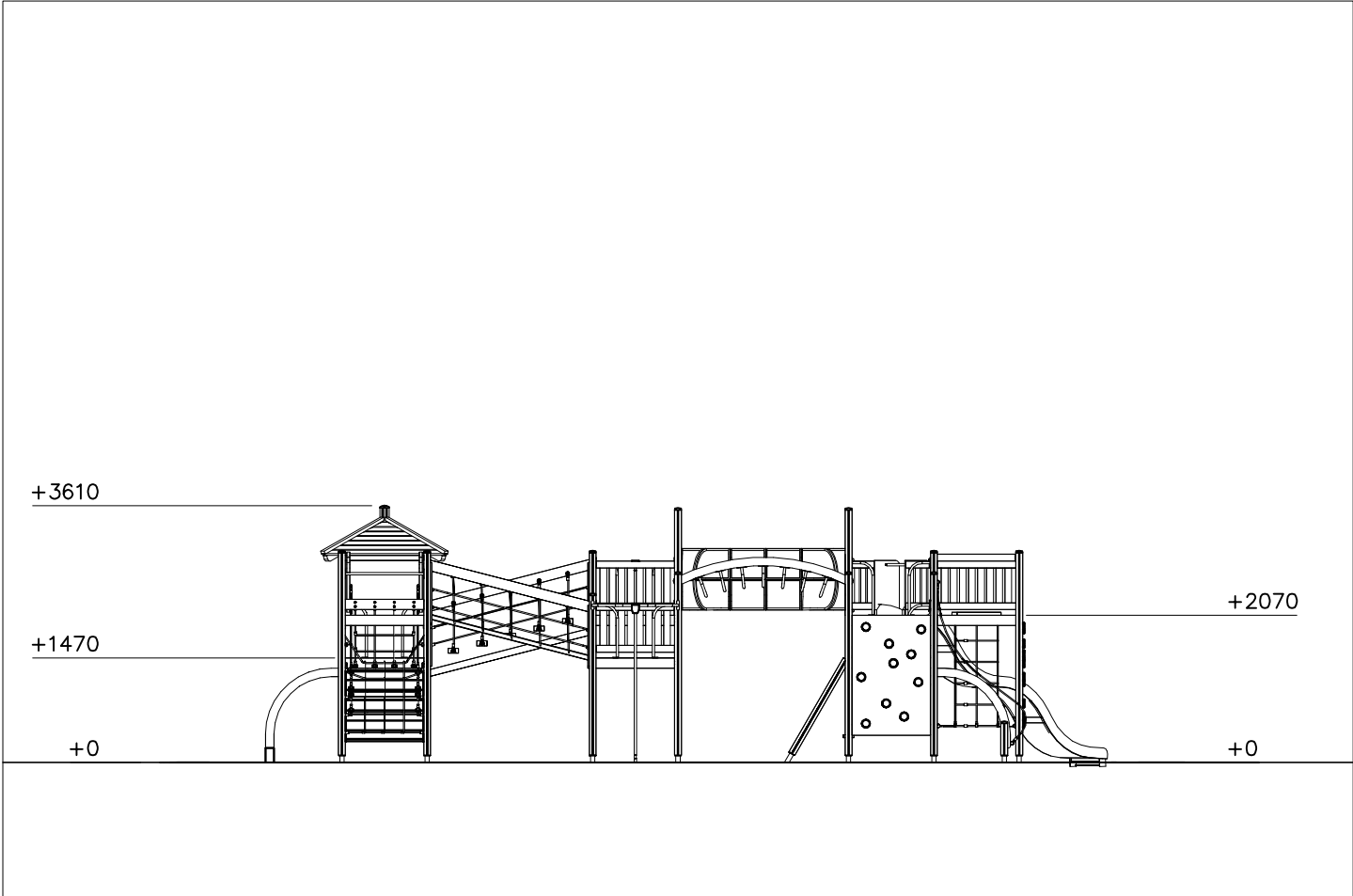

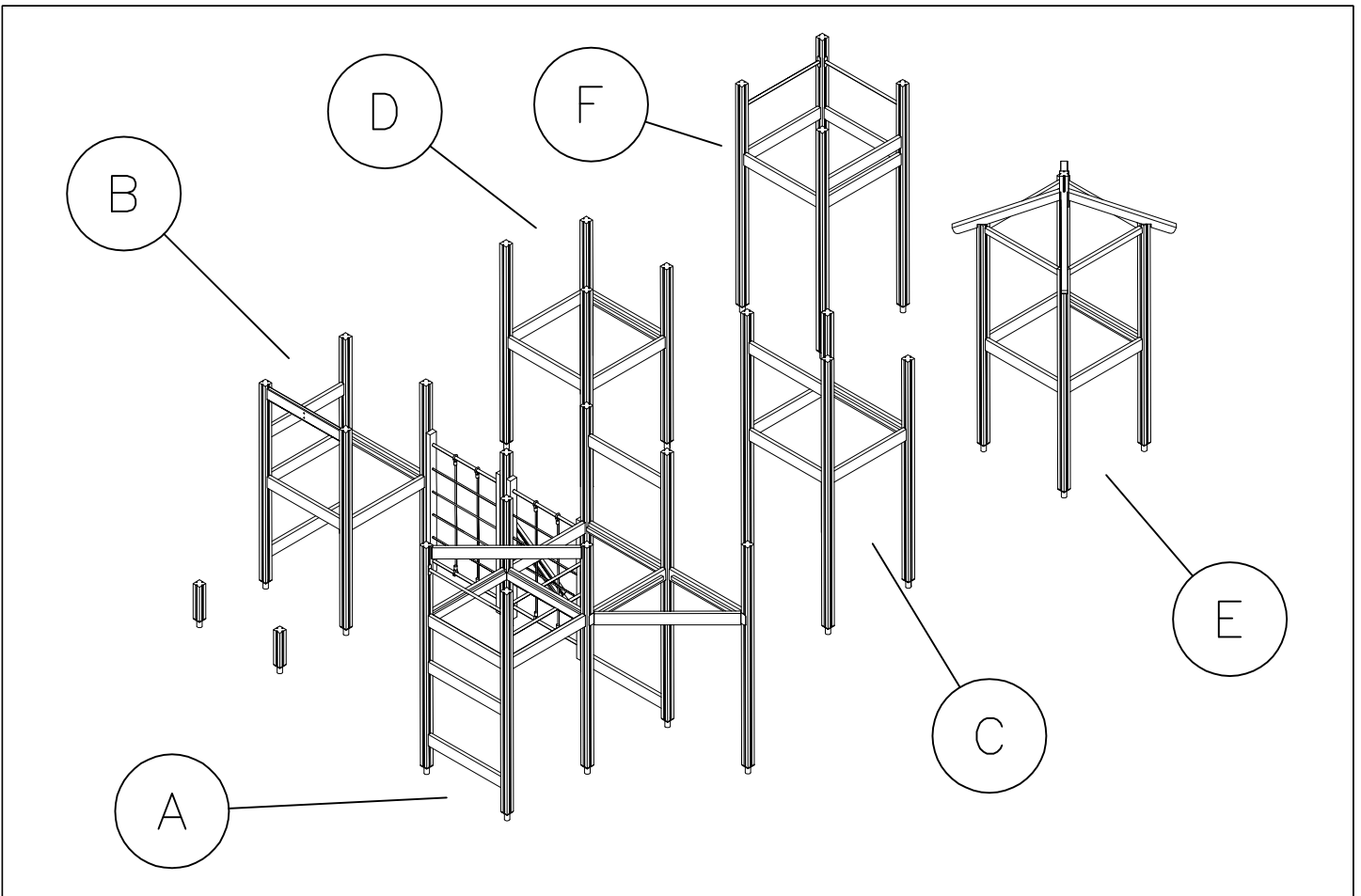
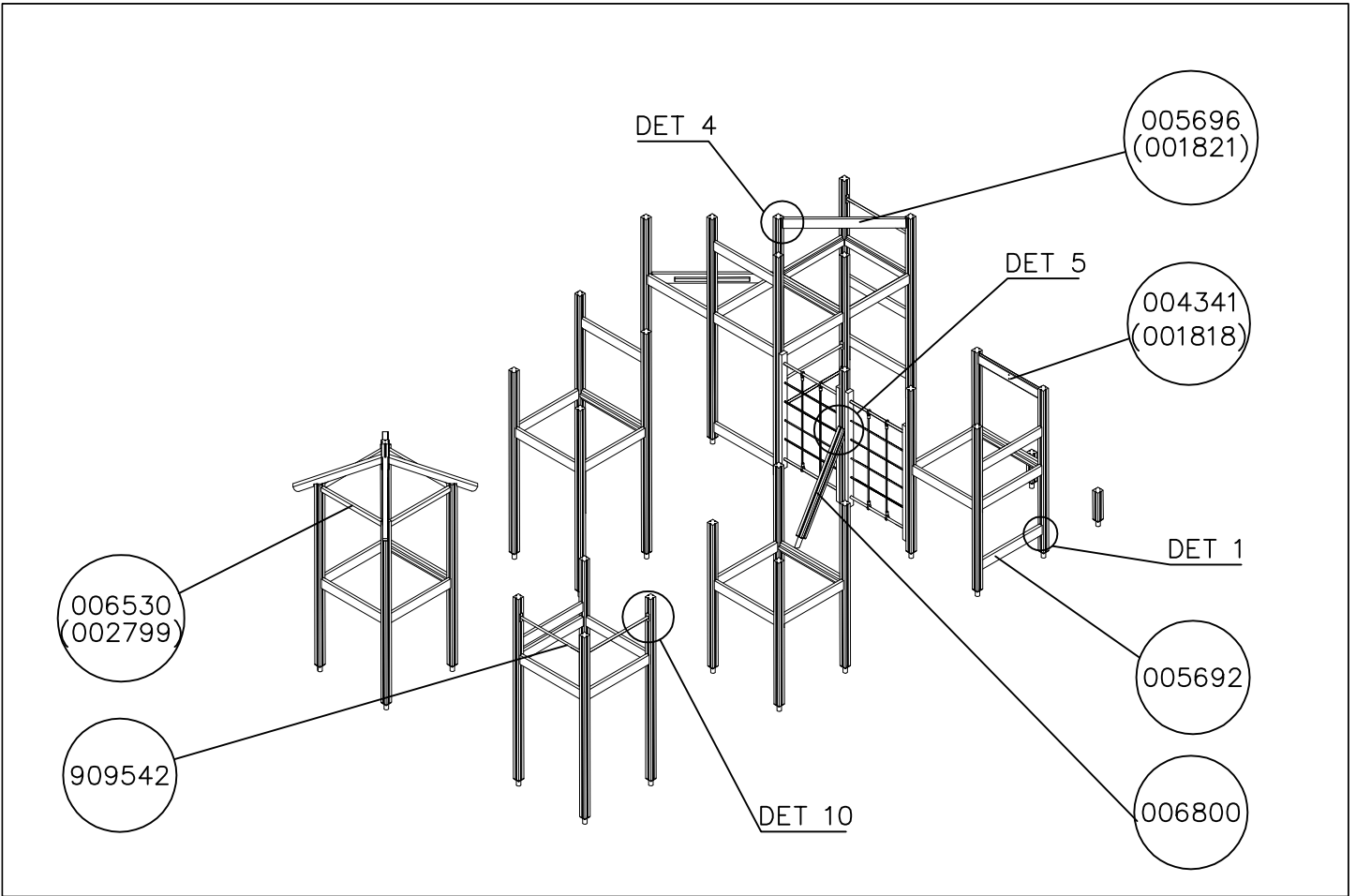



<p>DET 1</p>	<p>DET 2</p>	<p>DET 3</p>	<p>DET 4</p>
<p>DET 5</p>	<p>DET 6</p>	<p>DET 7</p>	<p>DET 8</p>
<p>DET 9</p>	<p>DET 10</p>	<p>DET 11</p>	<p>DET 12</p>

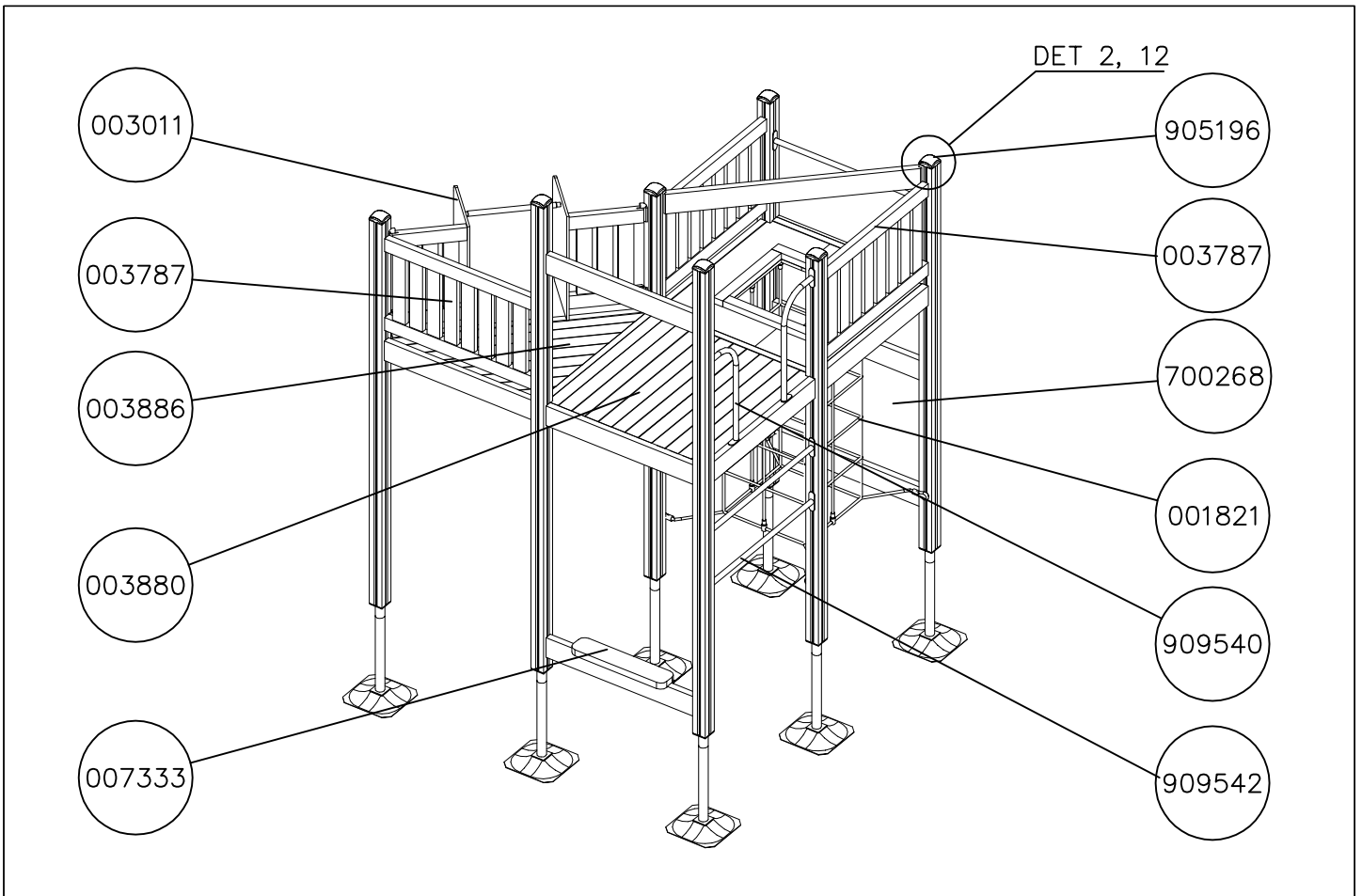
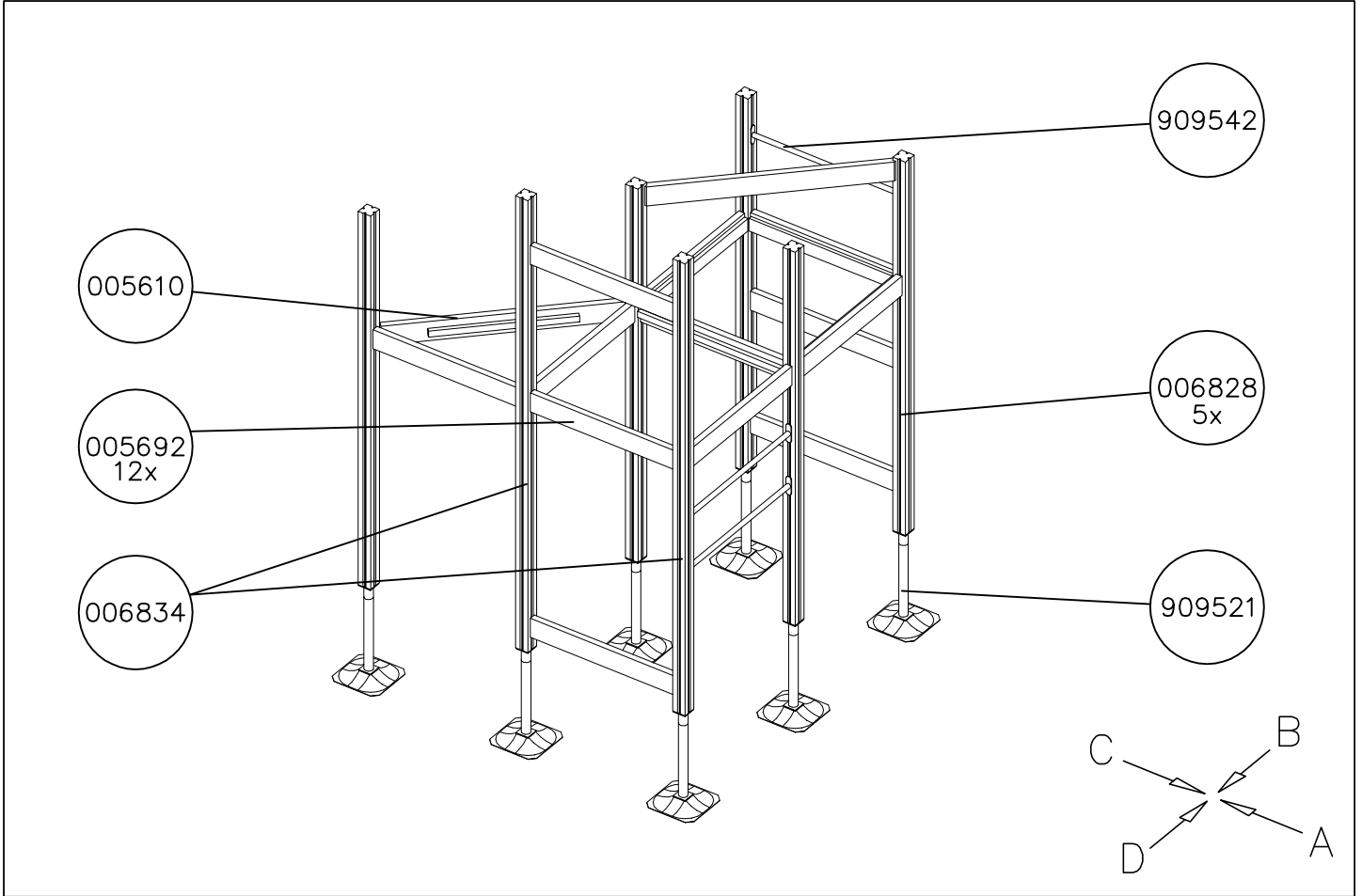

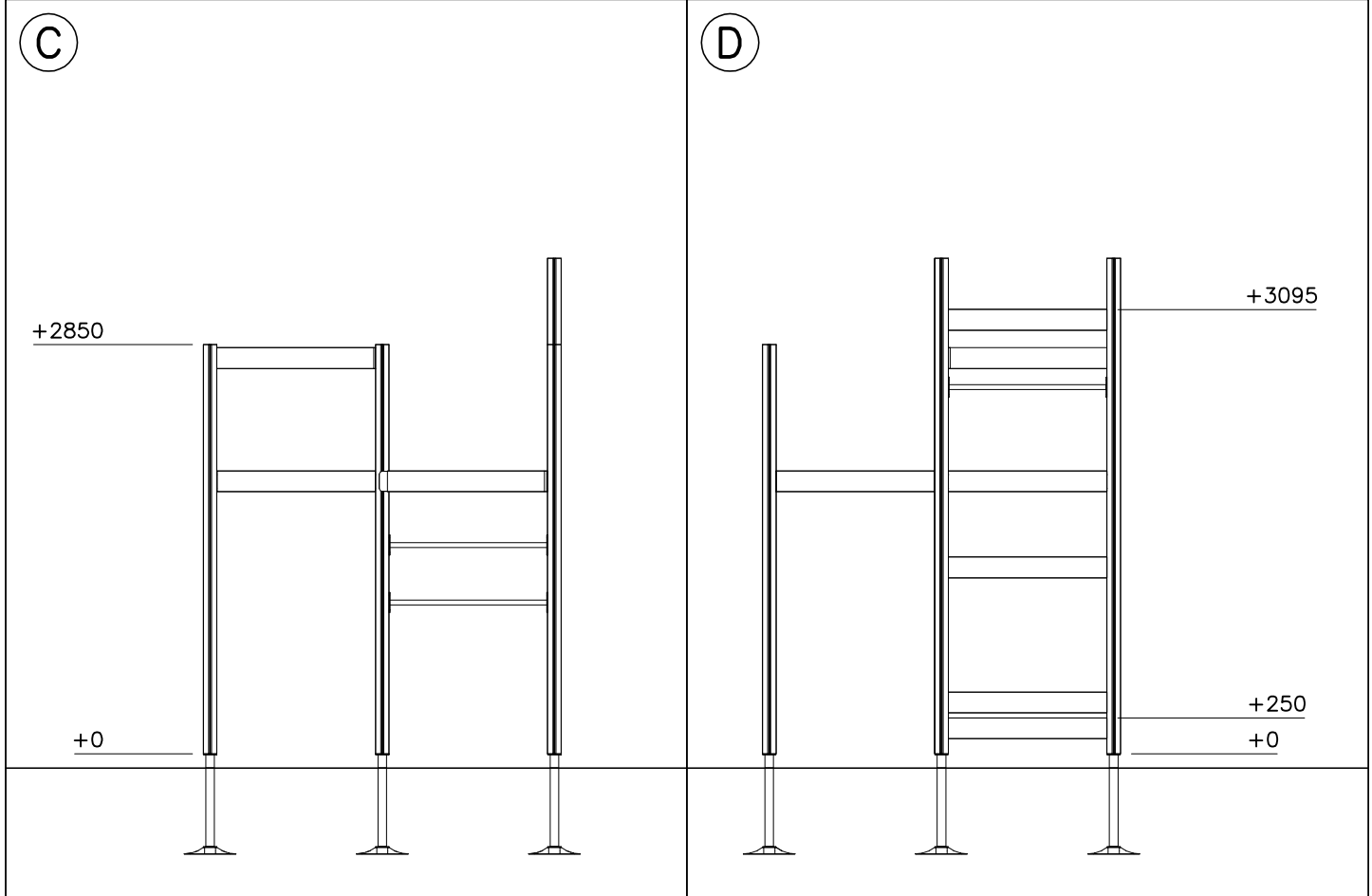
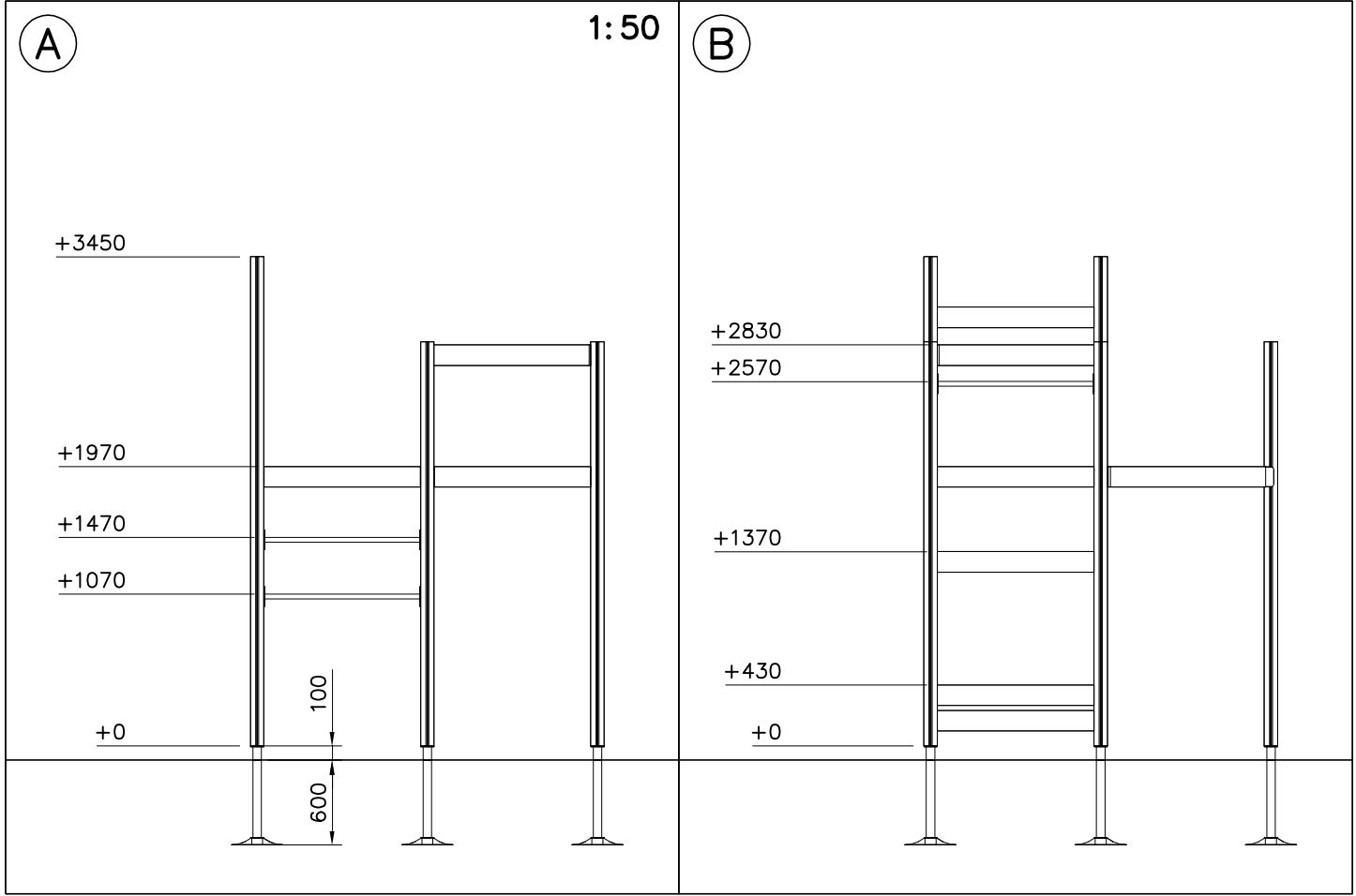

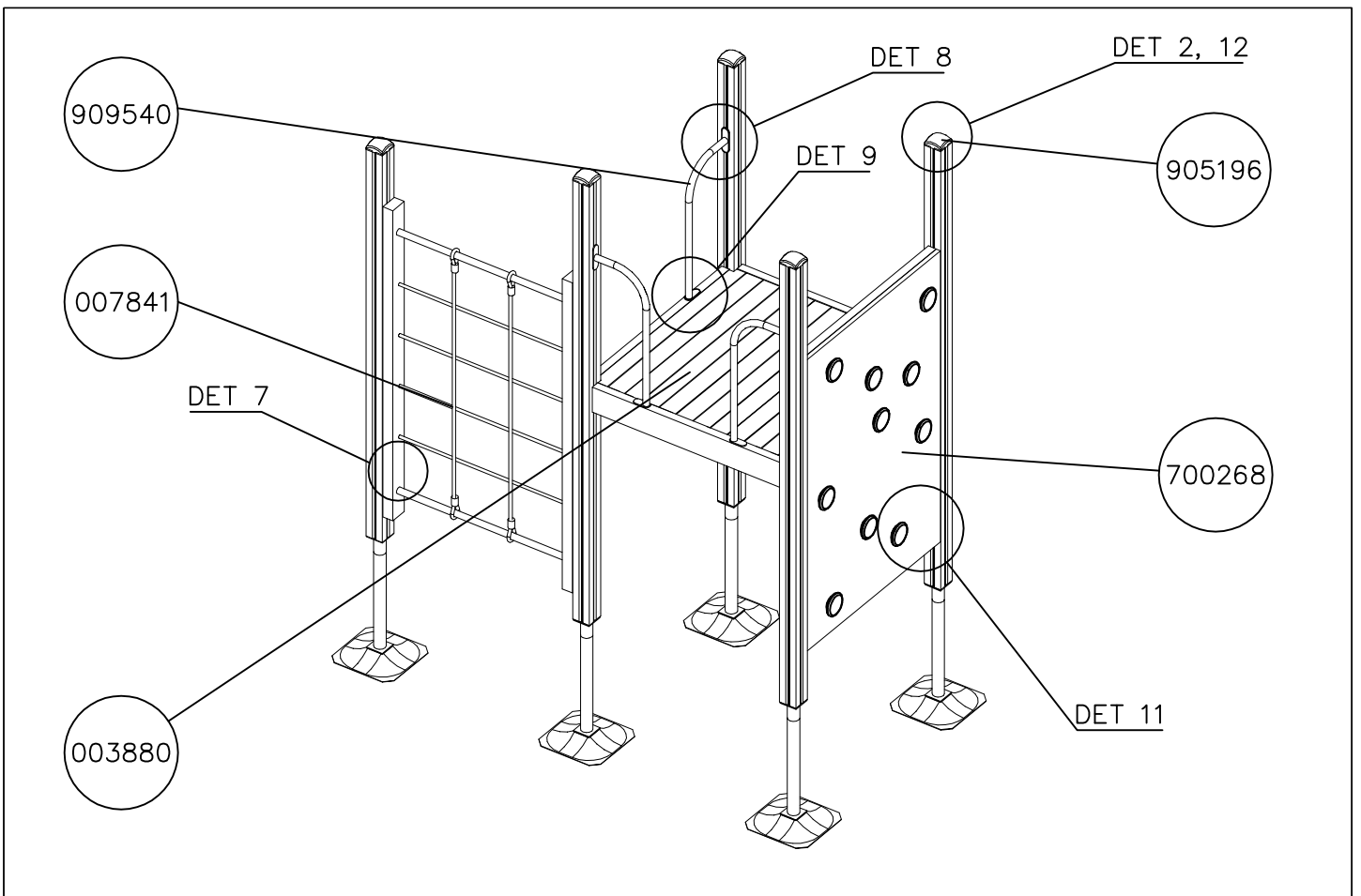
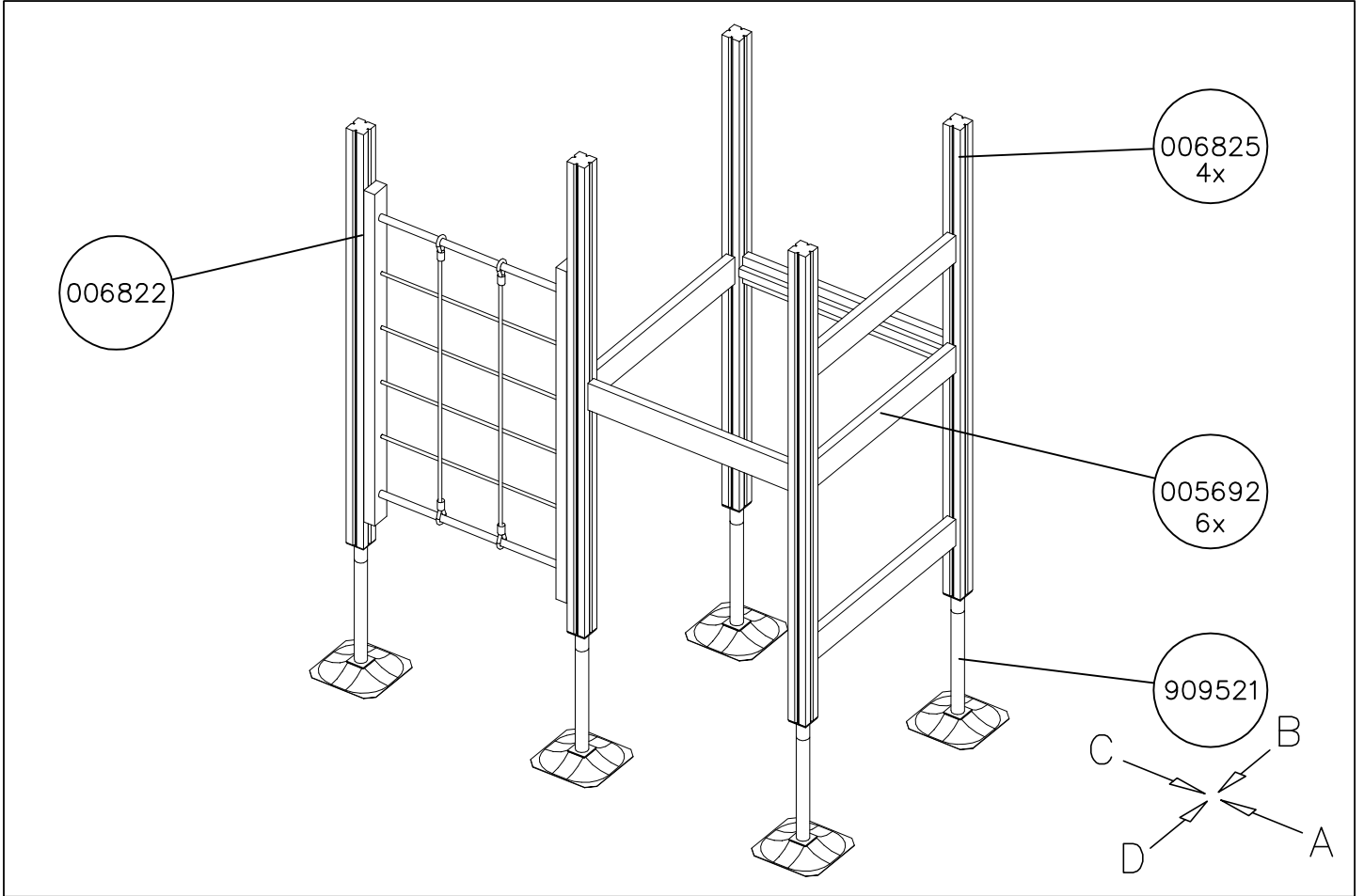

1: 50

(A)

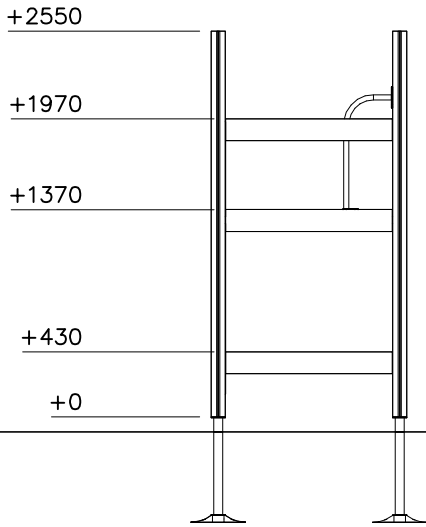

(B)

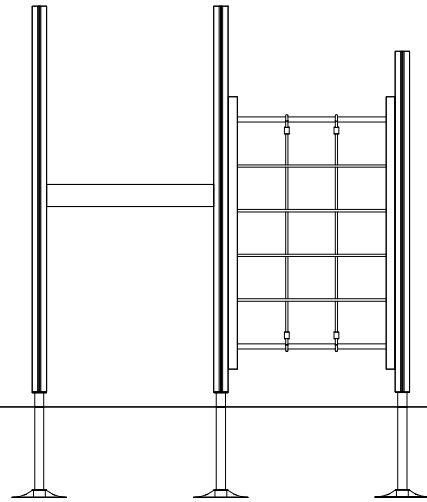

(C)

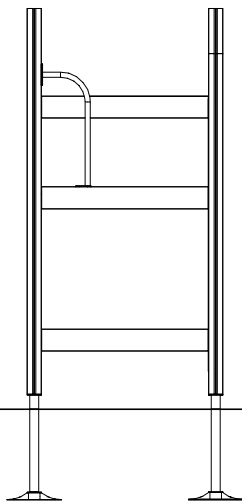

(D)

