

LAPPSET®

FINNO

ASENNUSOHJE
MONTERINGSANSVISNING
INSTALLATION INSTRUCTION
AUFBAUANLEITUNG
NOTICE D'INSTALLATION

REF: 120346
DATE: 15.6.2003

120346



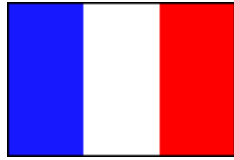
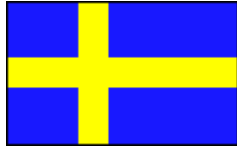

001770	PCS 1	001849	PCS 1	002799	PCS 1	003010	PCS 1	003614	PCS 1	003700	PCS 2
003787	PCS 2	005273	PCS 1	005277	PCS 1	005285	PCS 1	005692	PCS 1	006810	PCS 2
	BLUE							L 1104		L 1050	
006828	PCS 4	007333	PCS 1	905051	PCS 4	905104	PCS 24	905120	PCS 20	905138	PCS 2
L 2850				Ø24/8.4		M10		Ø14		GREY	
905196	PCS 2	909238	PCS 4	909521	PCS 6	980131	PCS 8				
GREY		8x90				6x60					
	PCS		PCS		PCS		PCS		PCS		PCS
	PCS		PCS		PCS		PCS		PCS		PCS
	PCS		PCS		PCS		PCS		PCS		PCS

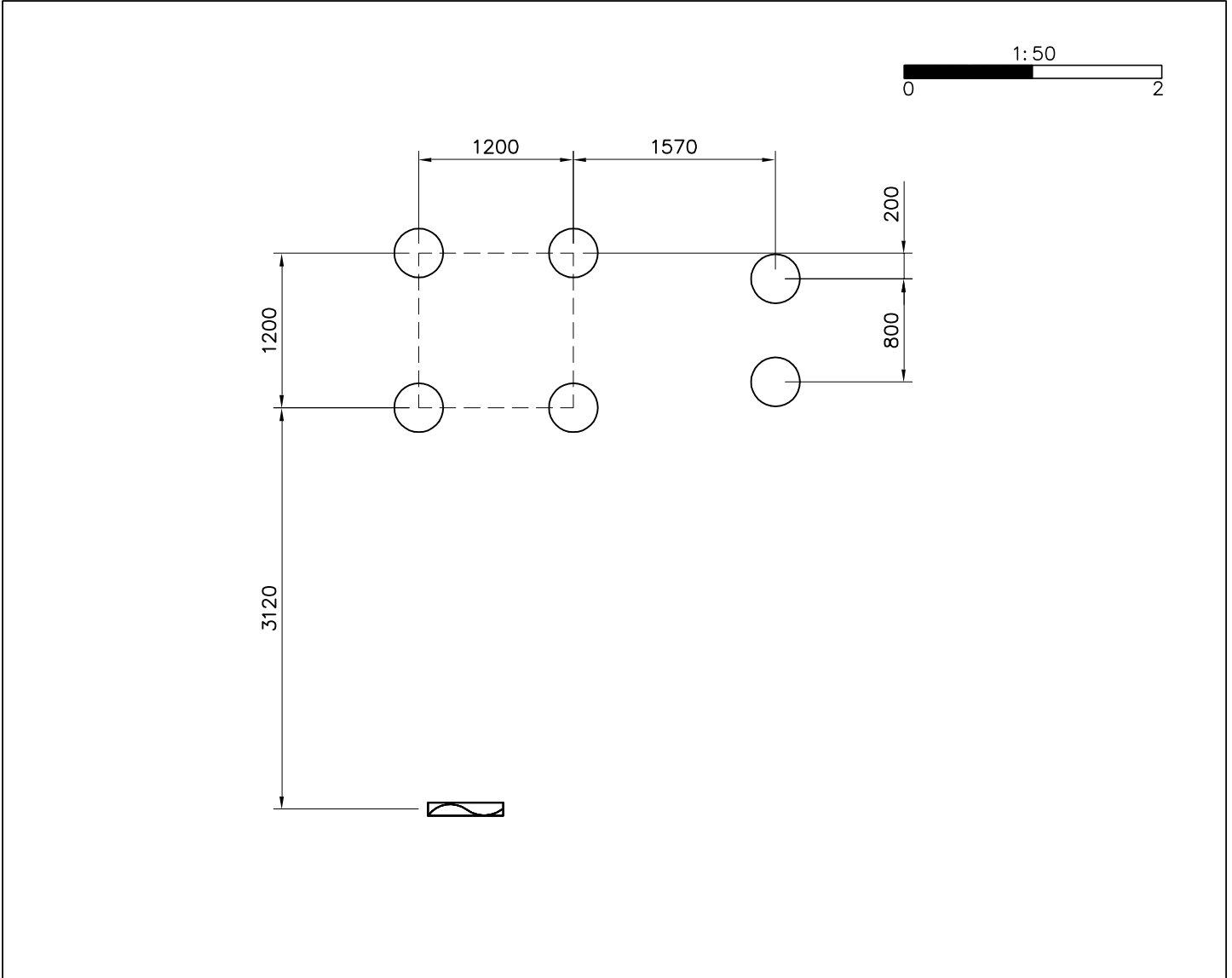

<p>M10 905104 909521</p>	<p>Sand 0.2-2 mm/ Gravel 2-8 mm</p> <p>100 300 600</p>	<p>Sand 0.2-2 mm/ Gravel 2-8 mm</p> <p>300 400</p>	

EN Impact Area 31.7 m²

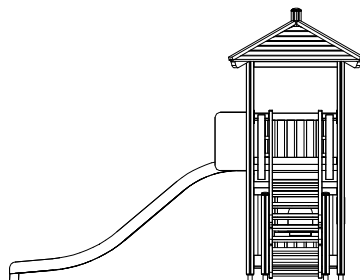
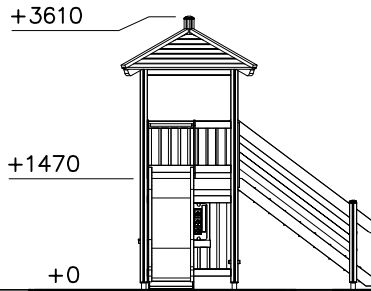
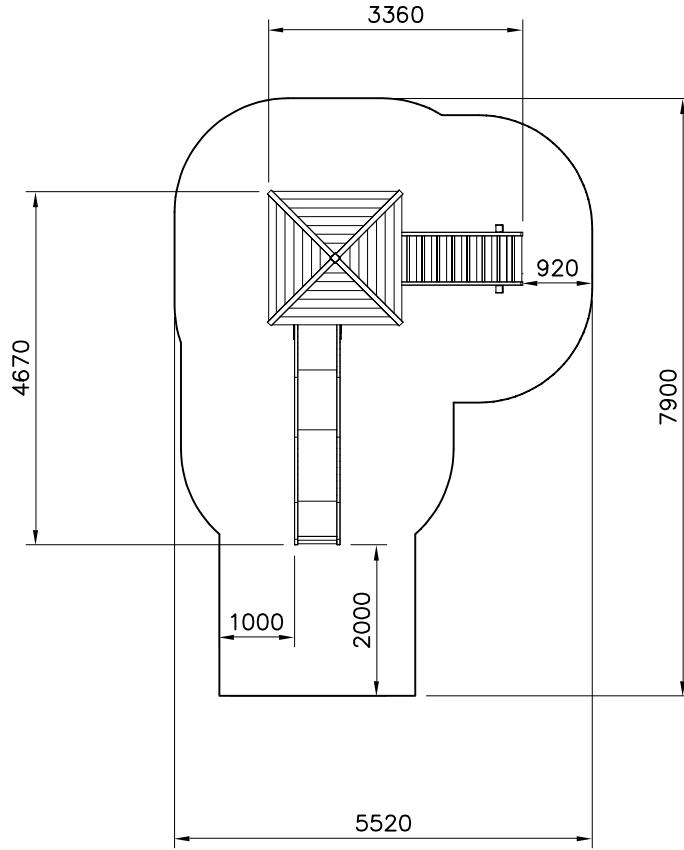
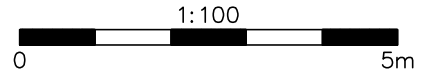

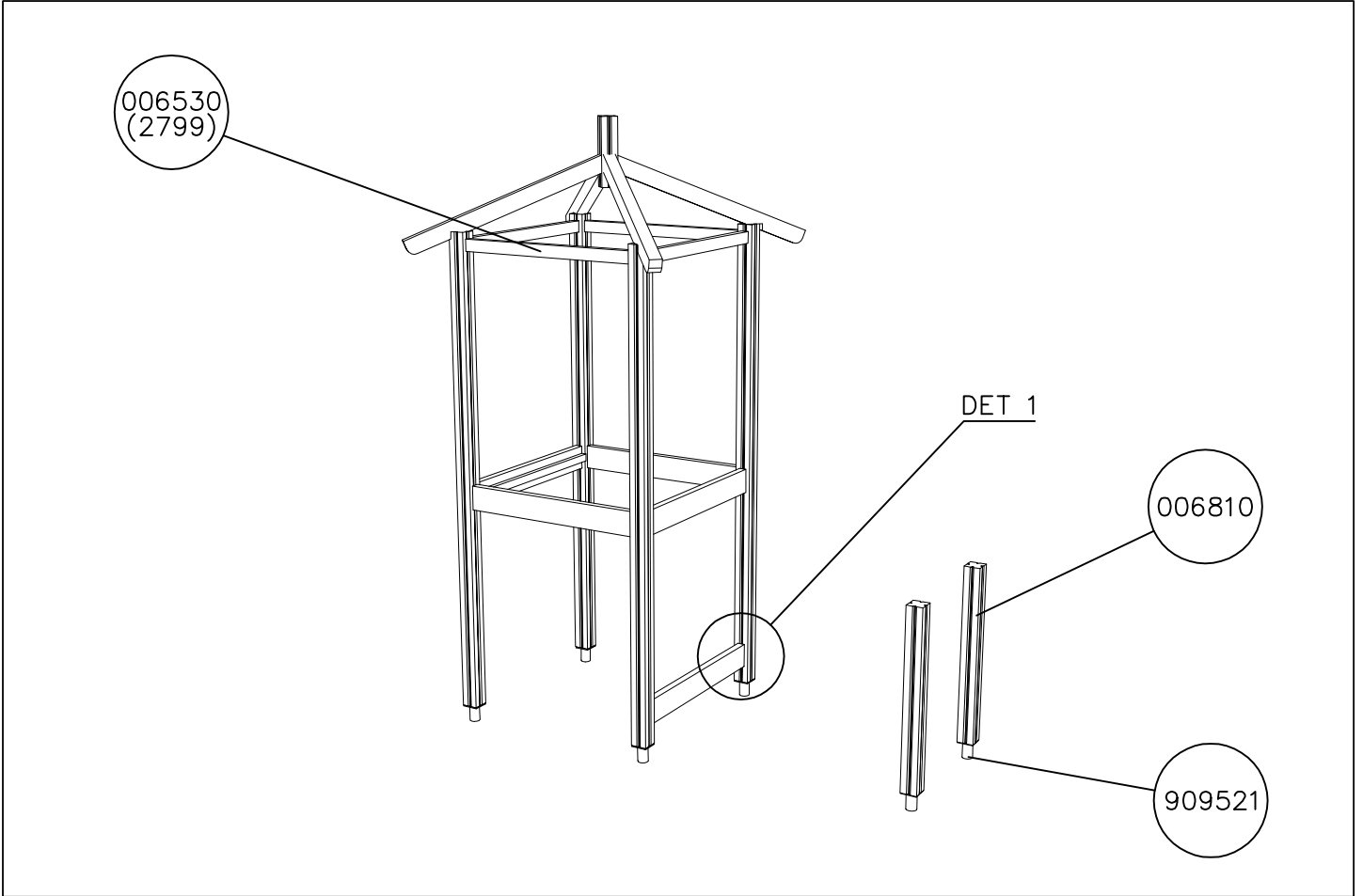

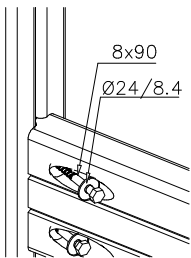
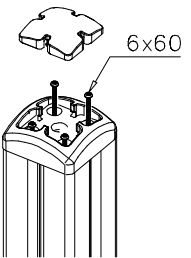
DET 1 	DET 2 	DET 3 