

LAPPSET®

FOREST







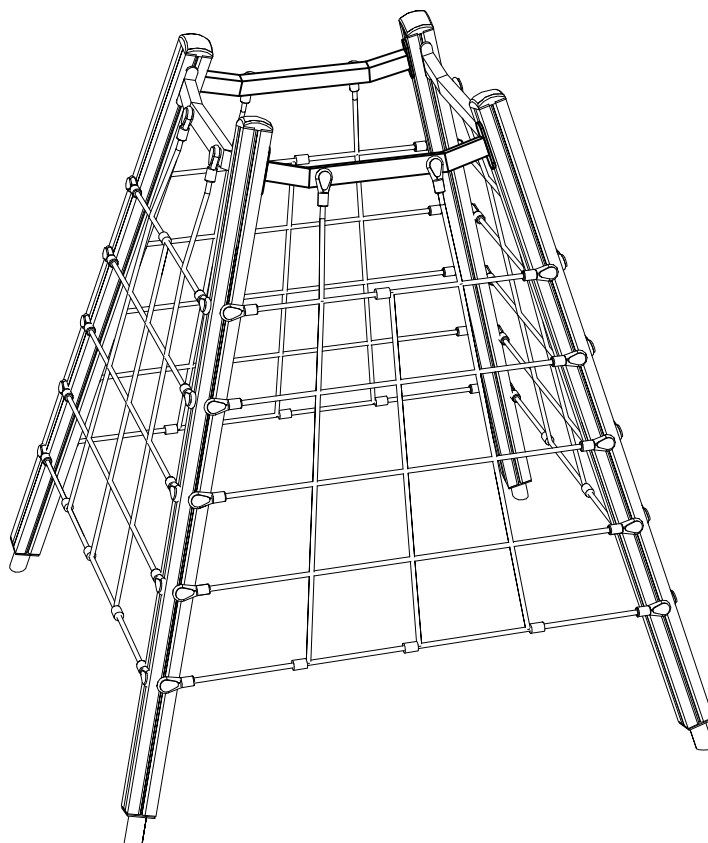

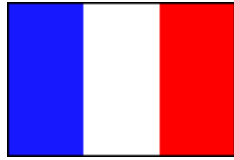
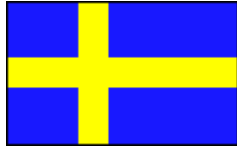

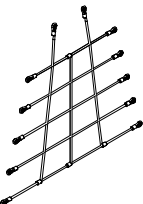

ASENNUSOHJE
MONTERINGSANSVISNING
INSTALLATION INSTRUCTION
AUFBAUANLEITUNG
NOTICE D'INSTALLATION

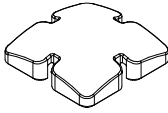
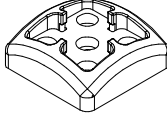
REF: 138072
DATE: 15.6.2003

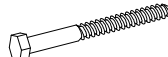
138072

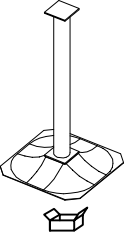



006822  L 2250	PCS 4	007552 	PCS 4	905083  Ø32	PCS 24	905104  M10	PCS 16	905112  Ø22	PCS 72	905120  Ø14	PCS 8
905137  YELLOW	PCS 4	905195  YELLOW	PCS 4	909217  8x70	PCS 40	909238  8x90	PCS 16	909267  8x70	PCS 8	909521 	PCS 4
909555 	PCS 4	980131  6x60	PCS 16	980150  M8	PCS 8	980151  Ø16/8.4	PCS 72		PCS		PCS
	PCS		PCS		PCS		PCS		PCS		PCS
	PCS		PCS		PCS		PCS		PCS		PCS
	PCS		PCS		PCS		PCS		PCS		PCS
	PCS		PCS		PCS		PCS		PCS		PCS

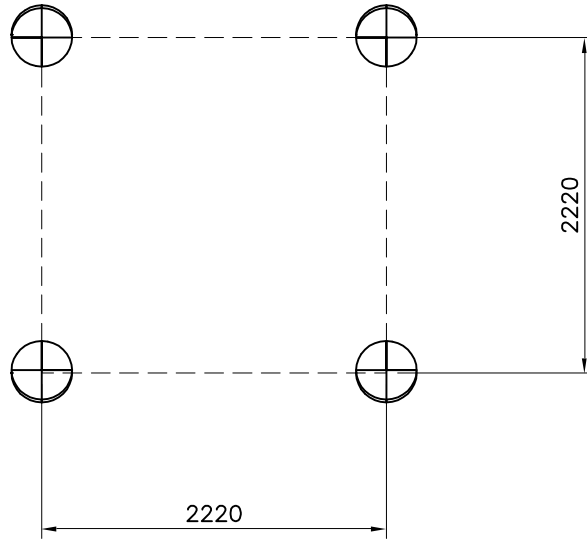
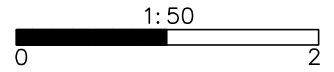

<p>M10 905104 909521</p>	<p>Sand 0.2-2 mm / Gravel 2-8 mm 100 300 580</p>		

EN Impact Area 21.2 m²

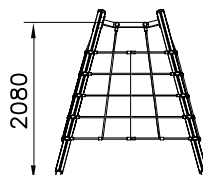
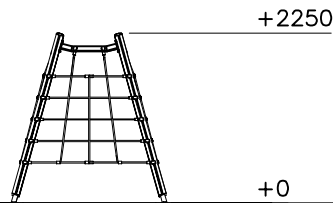
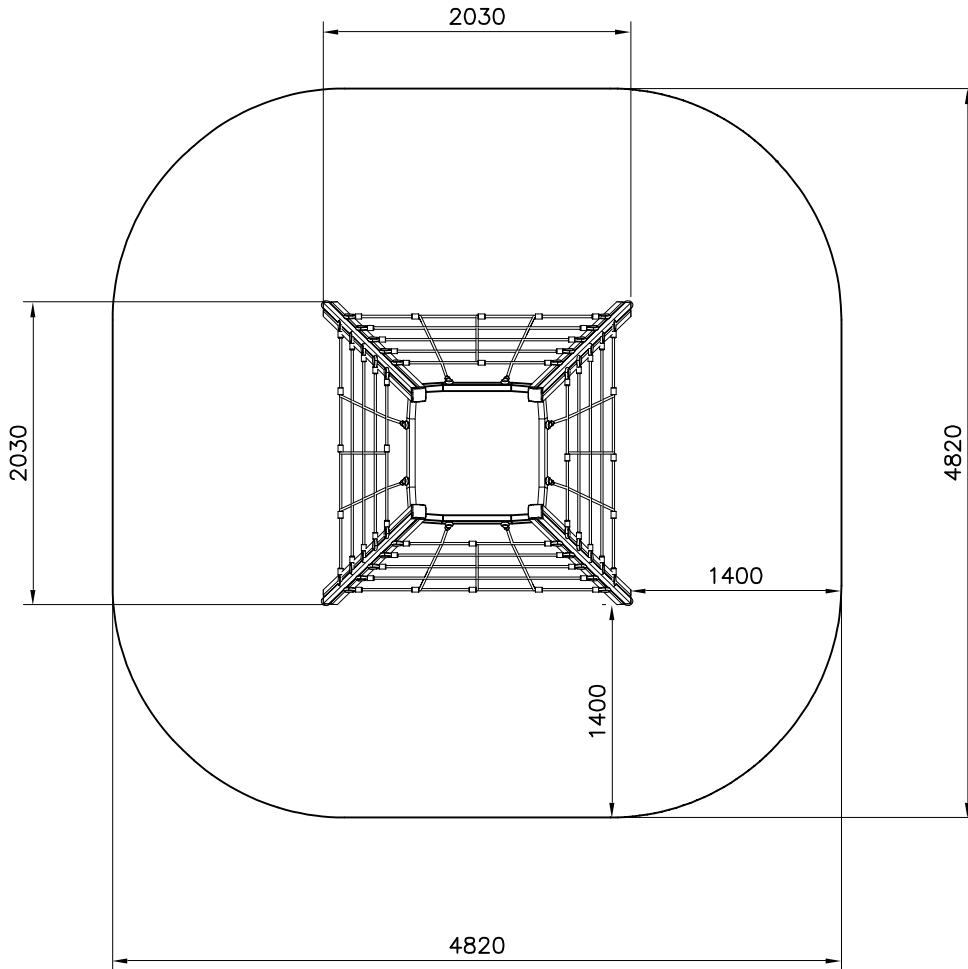
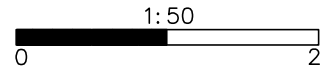

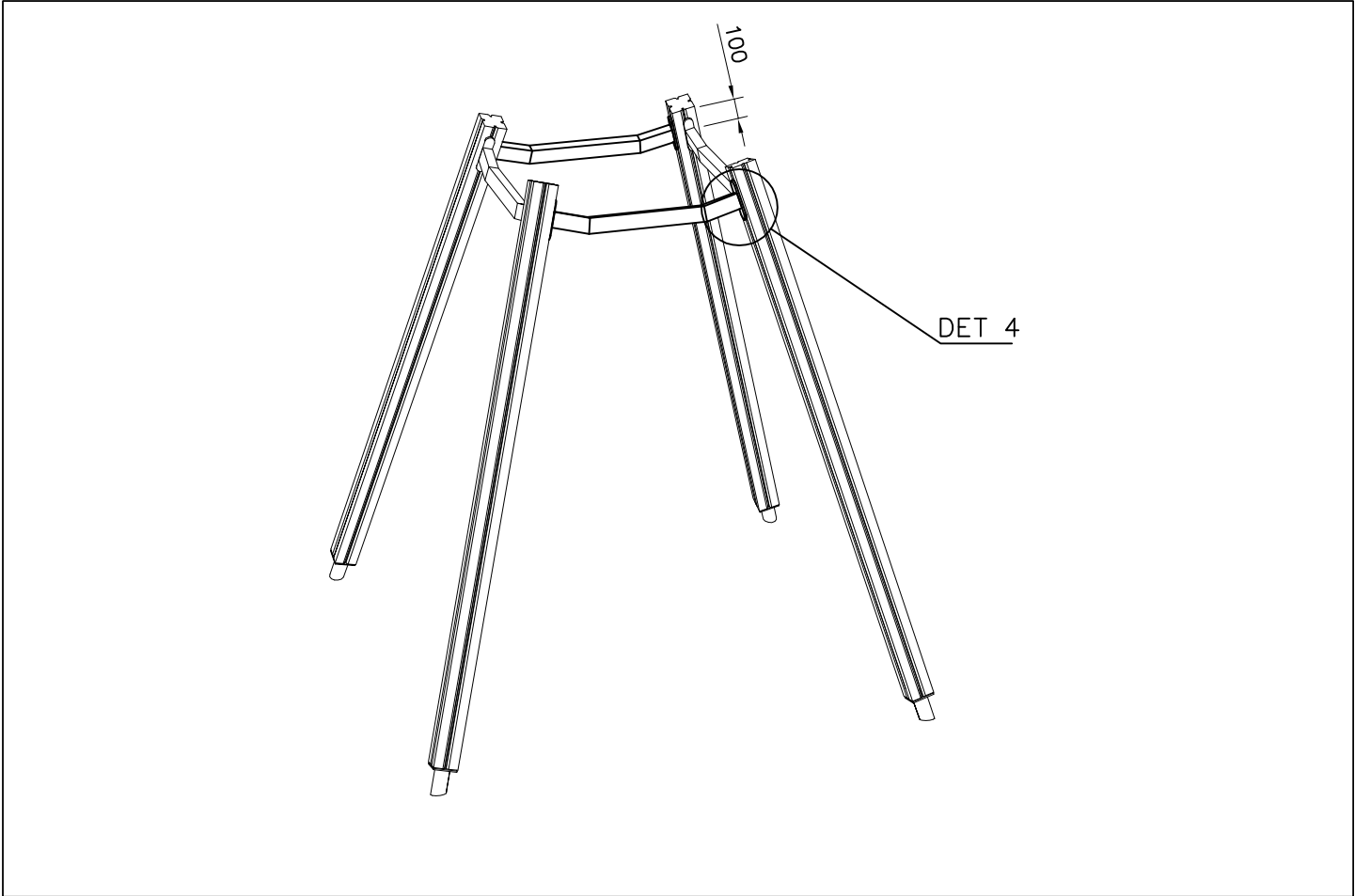

<p>DET 1</p> <p>6x60</p>	<p>DET 2</p> <p>905112</p> <p>8x70</p> <p>Ø16/8.4</p>	<p>DET 3</p> <p>8x70</p> <p>905083</p> <p>Ø16/8.4</p> <p>M8</p> <p>905112</p>	<p>DET 4</p> <p>905083</p> <p>Ø16/8.4</p> <p>8x90</p> <p>905112</p>
<p>DET 5</p> <p>905120</p>			

