

# **LAPPSET®**







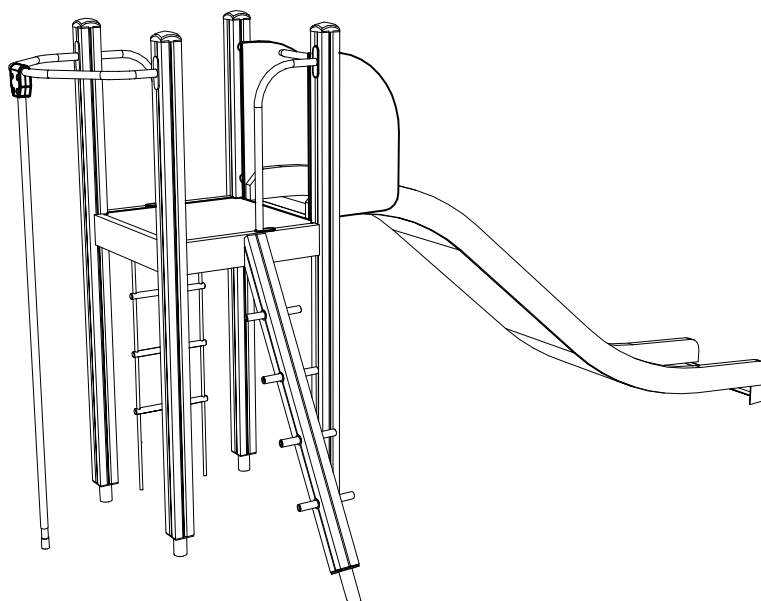

## **FOREST**

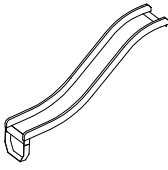
ASENNUSOHJE  
MONTERINGSANSVISNING  
INSTALLATION INSTRUCTION  
AUFBAUANLEITUNG  
NOTICE D'INSTALLATION

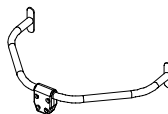
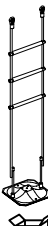
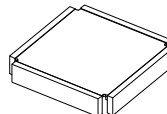
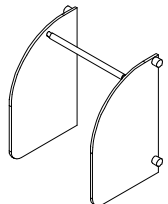
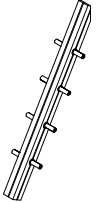
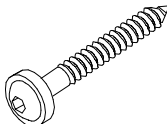
REF: 138150  
DATE: 1.4.2005

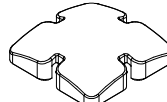
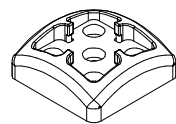
# **138150**

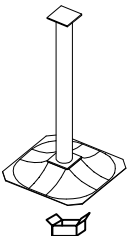
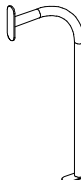

003614  L 2250	PCS 1	006822  L 2250	PCS 4	007077  L 2250	PCS 1	007229  L 2250	PCS 1	008701  L 2250	PCS 1	008790  L 2250	PCS 1
008910  L 2250	PCS 1	900240  8x70	PCS 6	905104  M10	PCS 20	905120  Ø14	PCS 8	905137  YELLOW	PCS 4	905195  YELLOW	PCS 4
907044  L 2090	PCS 1	909521  L 2090	PCS 5	909540  L 2090	PCS 2	980131  6x60	PCS 16		PCS		PCS
	PCS		PCS		PCS		PCS		PCS		PCS
	PCS		PCS		PCS		PCS		PCS		PCS
	PCS		PCS		PCS		PCS		PCS		PCS
	PCS		PCS		PCS		PCS		PCS		PCS

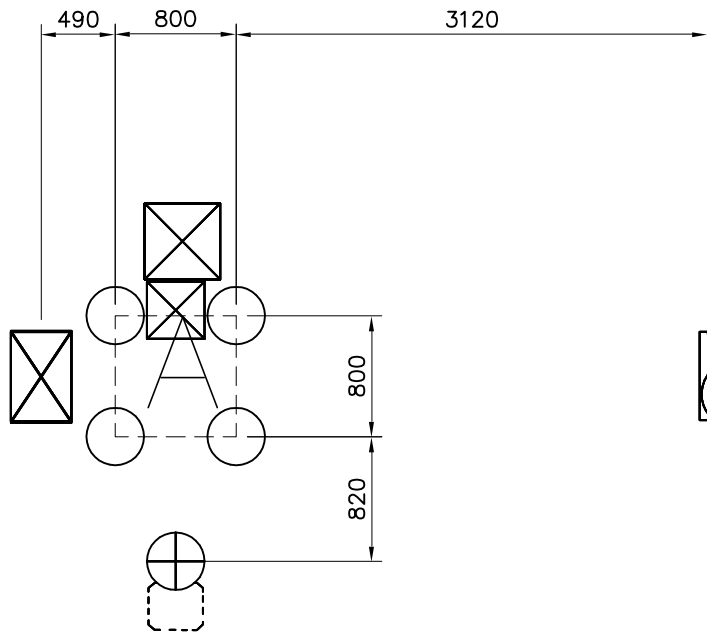
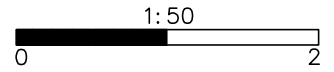

<p>M10 905104 909521</p>	<p>Sand 0.2-2 mm / Gravel 2-8 mm</p> <p>100 300 600</p>	<p>Sand 0.2-2 mm / Gravel 2-8 mm</p> <p>100 300 580</p>
<p>Sand 0.2-2 mm / Gravel 2-8 mm</p> <p>300 400</p>	<p>Sand 0.2-2 mm / Gravel 2-8 mm</p> <p>300 600</p>	

EN Impact Area 30.7 m<sup>2</sup>

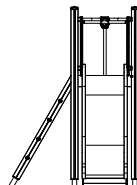
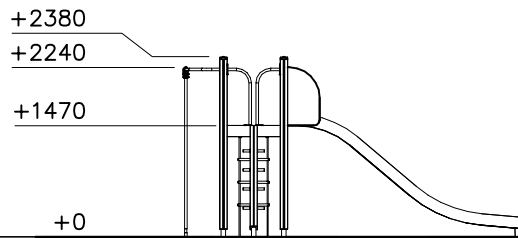
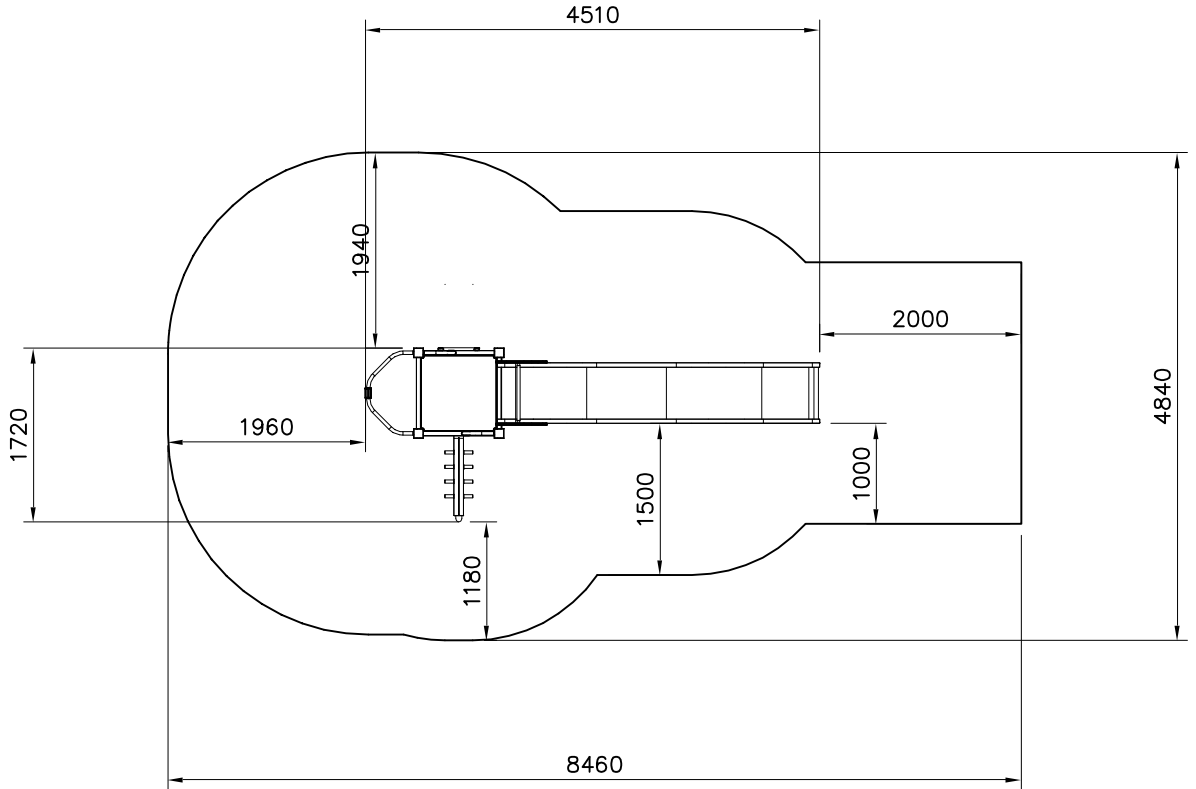
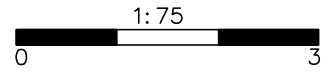

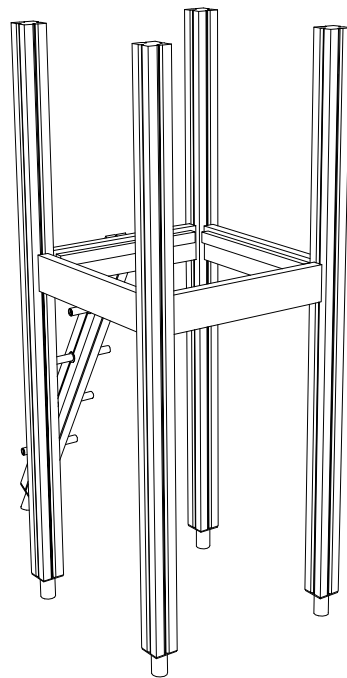
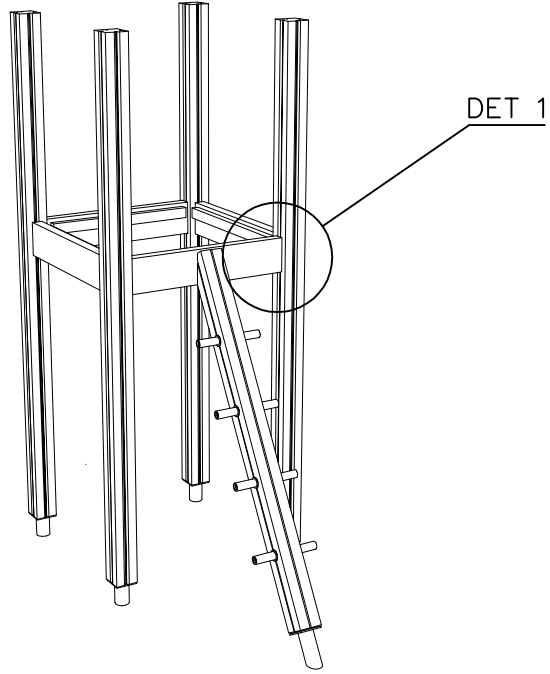

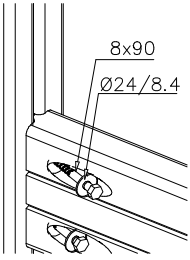
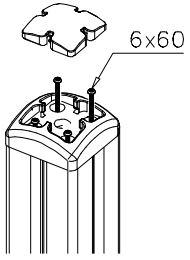
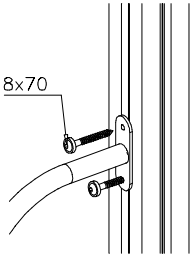
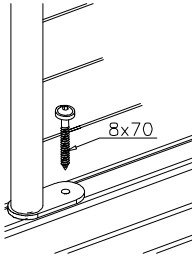
<p>DET 1</p> 	<p>DET 2</p> 	<p>DET 3</p> 	<p>DET 4</p> 
<p>DET 5</p> 