



 704699	<p>1 PCS</p>	 905083	<p>3 PCS</p>	 905112	<p>3 PCS</p>
 980160	<p>3 PCS</p>	 909256	<p>6 PCS</p>	 901899	<p>3 PCS</p>
 909855	<p>3 PCS</p>		<p>PCS</p>		<p>PCS</p>



Assembly instruction:

- Measure 704699 to desired position
- Use bottom holes of 704699 as a template and mark 3 bolt holes
- Drill 10mm holes for attachment bolts
- Dissassemble the equipment to get access to backside of the holes
- Fasten the handle assembly using 35mm or 45mm screws depending on the board thickness
- Assemble the equipment

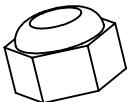
Asennus:

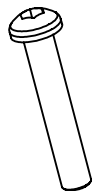
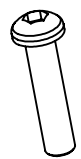
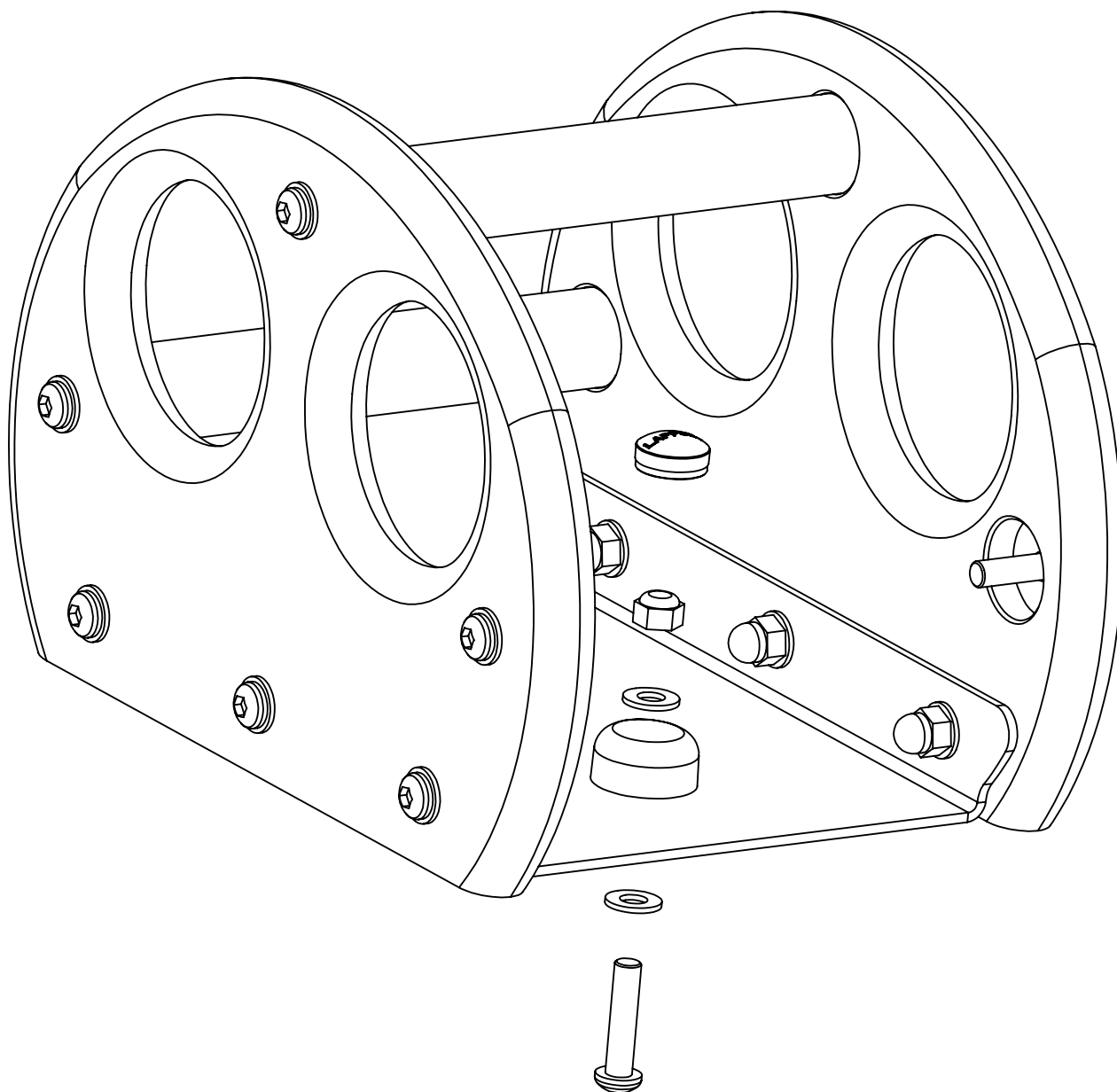
- Aseta kahvakokoonpano haluttuun kohtaan
- Merkaa reikien paikat pohjan läpi
- Puraa 10mm reiät
- Pura välinettä siten, että pystyt asentamaan ruuvit alapuolelta
- Kiinnitä kahvakokoonpano 35mm tai 45mm ruuveilla levyn paksuudesta riippuen
- Kokoa väline