

LAPPSET®

SPORT







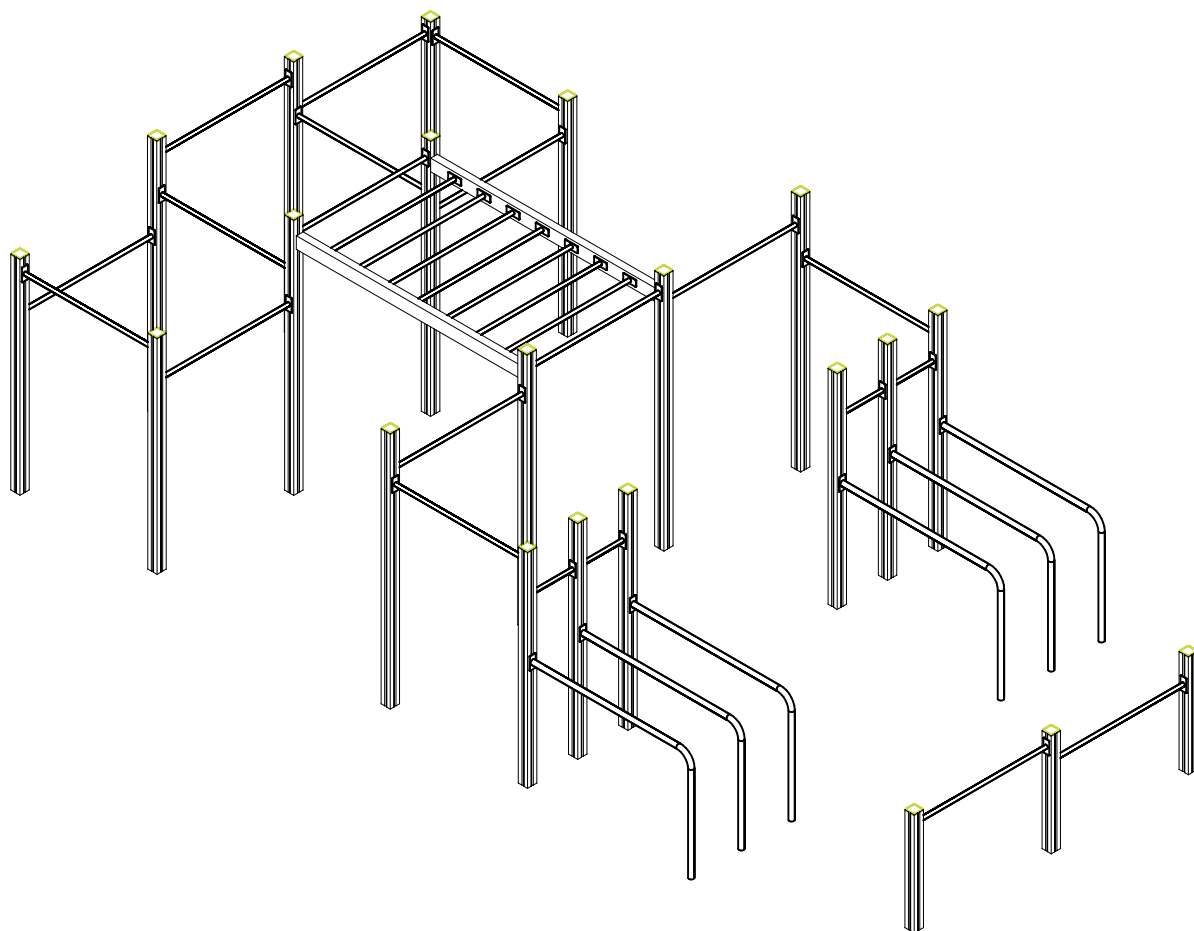

ASENNUSOHJE
MONTERINGSANSVISNING
INSTALLATION INSTRUCTION
AUFBAUANLEITUNG
NOTICE D'INSTALLATION

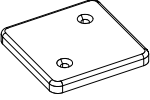
DATE: 11.4.2018

Q12167-1

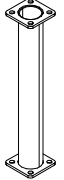
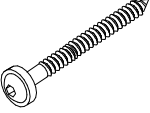
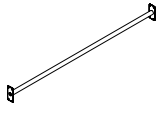
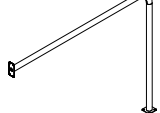
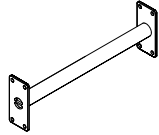

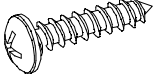
DATE: 11.4.2018

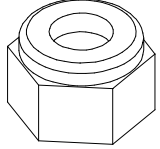
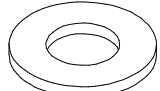
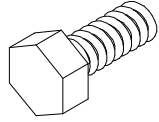
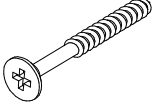
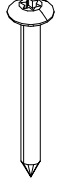
702286  65x65	PCS 1	706481-703  83x83x10	PCS 21	706527-604  93x93x1600	PCS 3	706568-604  93x93x3000	PCS 8	706810-604  93x93x2650	PCS 10	707294-604  70x120x2304	PCS 2
902272  90x90x450	PCS 6	903093  Ø8x90	PCS 32	908017-217  L 1315	PCS 24	908019-217  1500x1200	PCS 6	908062-217  L 420	PCS 4	909256  Ø16/8.4	PCS 248
909506  Ø3.5x13	PCS 4	909519  50x380x380	PCS 21	909637  M10	PCS 24	909638  Ø20/10.5	PCS 48	909639  M10x25	PCS 24	980107  Ø6x60	PCS 42
980123  Ø7x60	PCS 224		PCS	PCS	PCS	PCS	PCS	PCS	PCS	PCS	
	PCS		PCS		PCS		PCS		PCS		PCS
	PCS		PCS		PCS		PCS		PCS		PCS
	PCS		PCS		PCS		PCS		PCS		PCS

- EN/AS Impact Area 84.9 m²
- Falling Space 21.3 m²
- + Max+Falling Height 1300 mm +

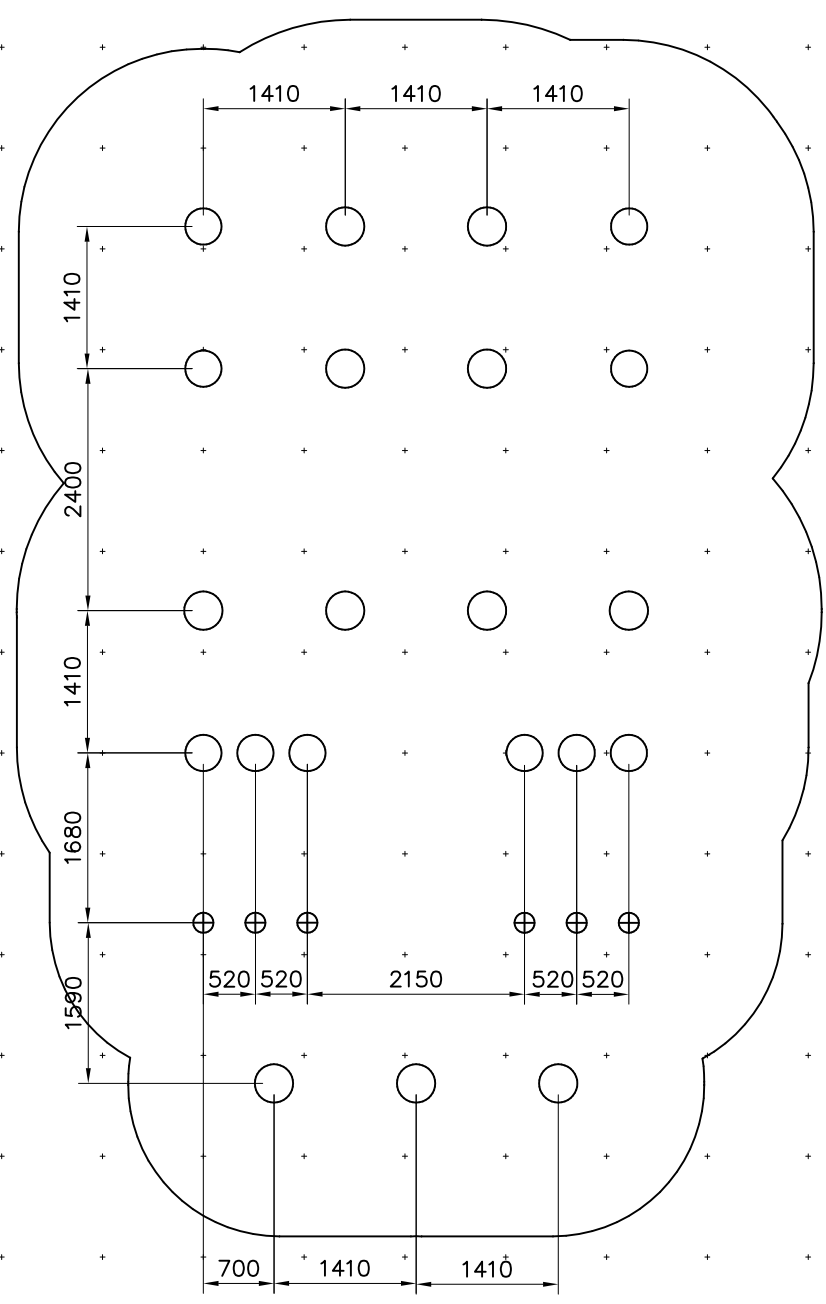
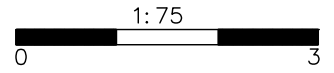

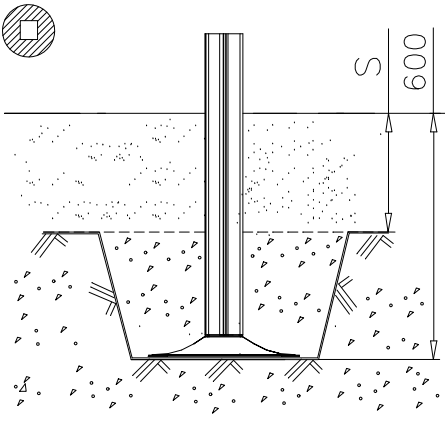
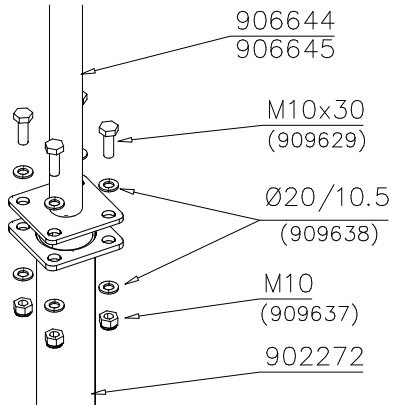

- EN/AS Impact Area 84.9 m²
- - - - Falling Space 21.3 m²
Max Falling Height 1300 mm

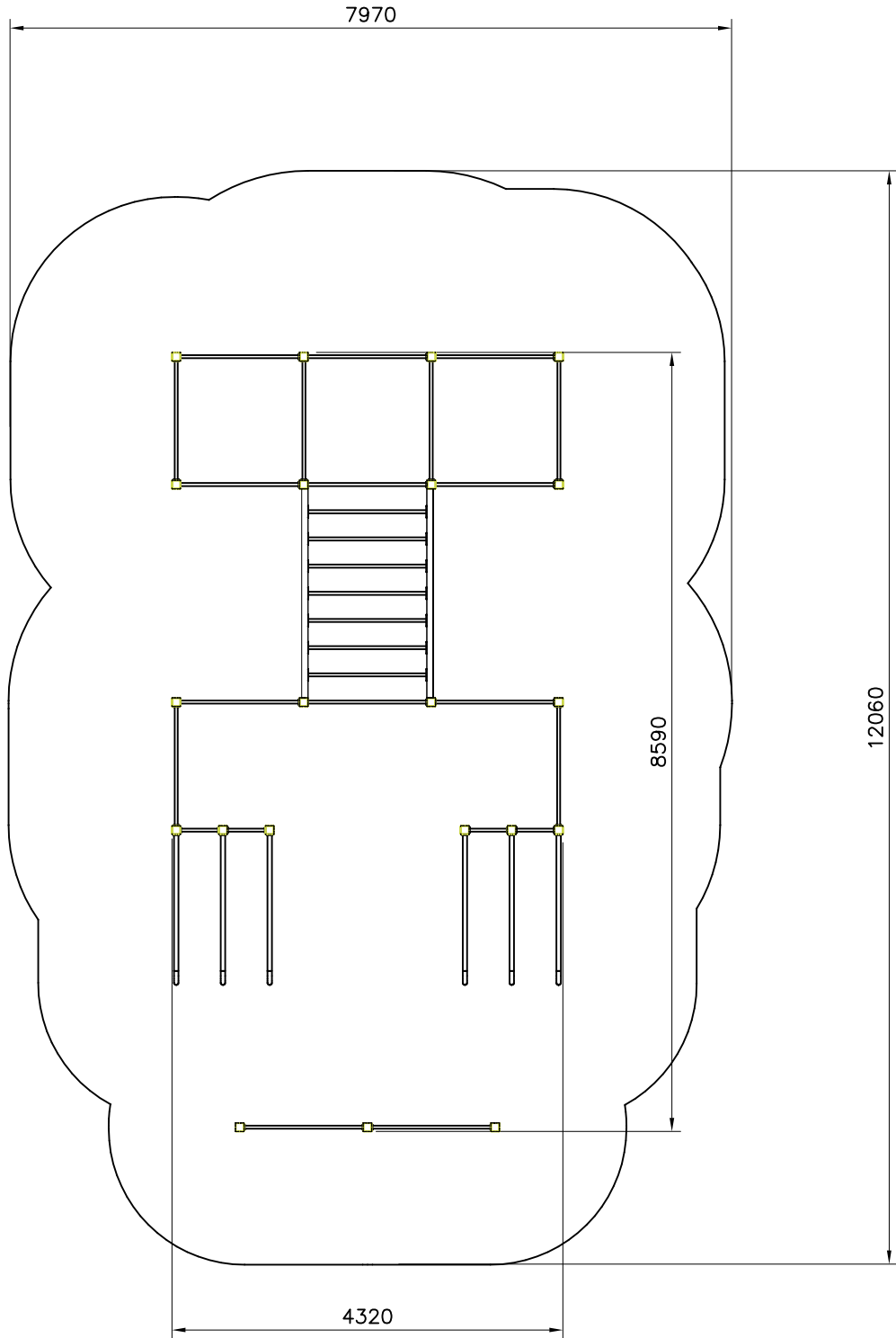
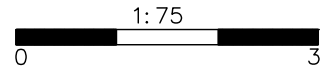

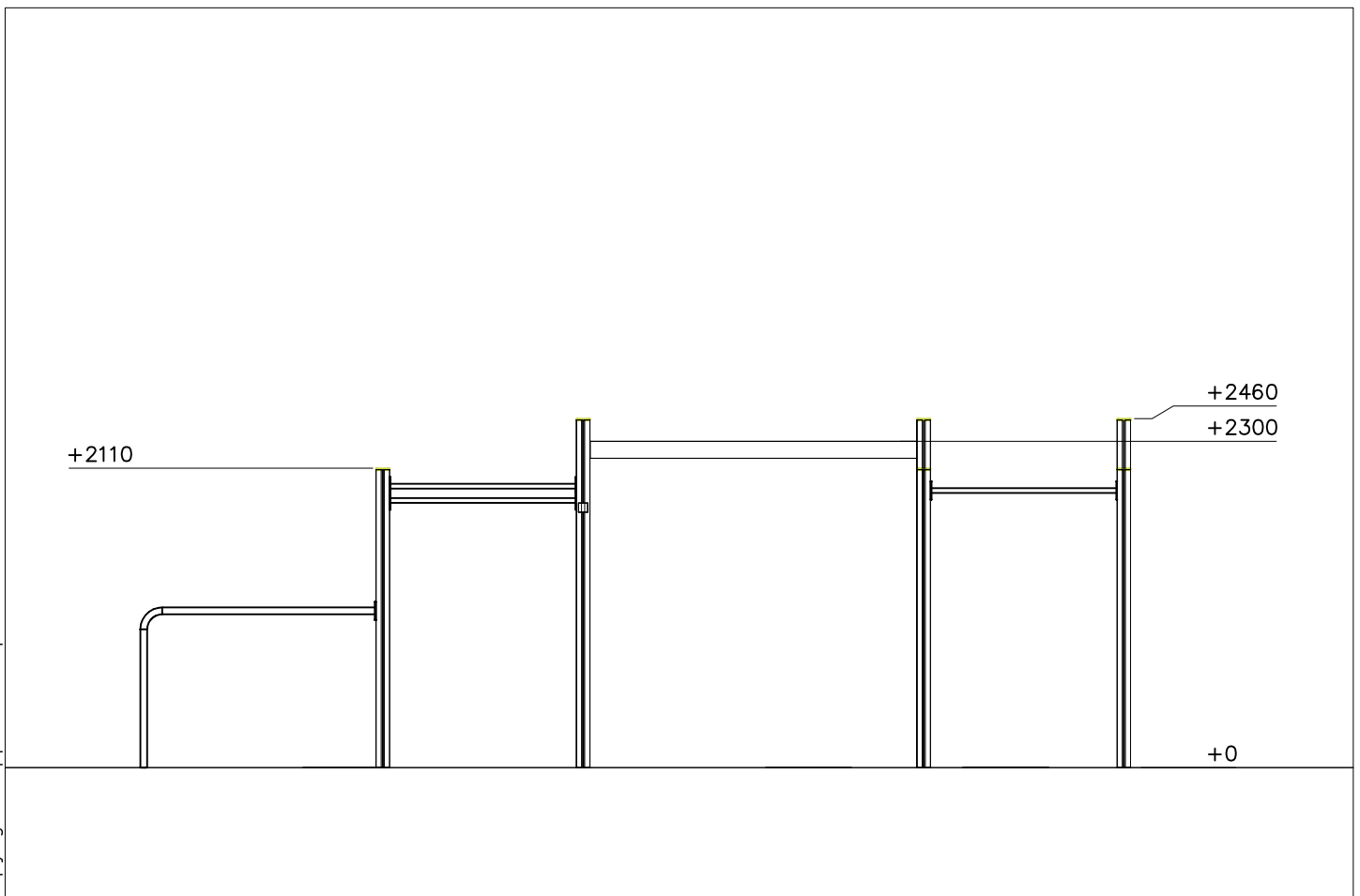
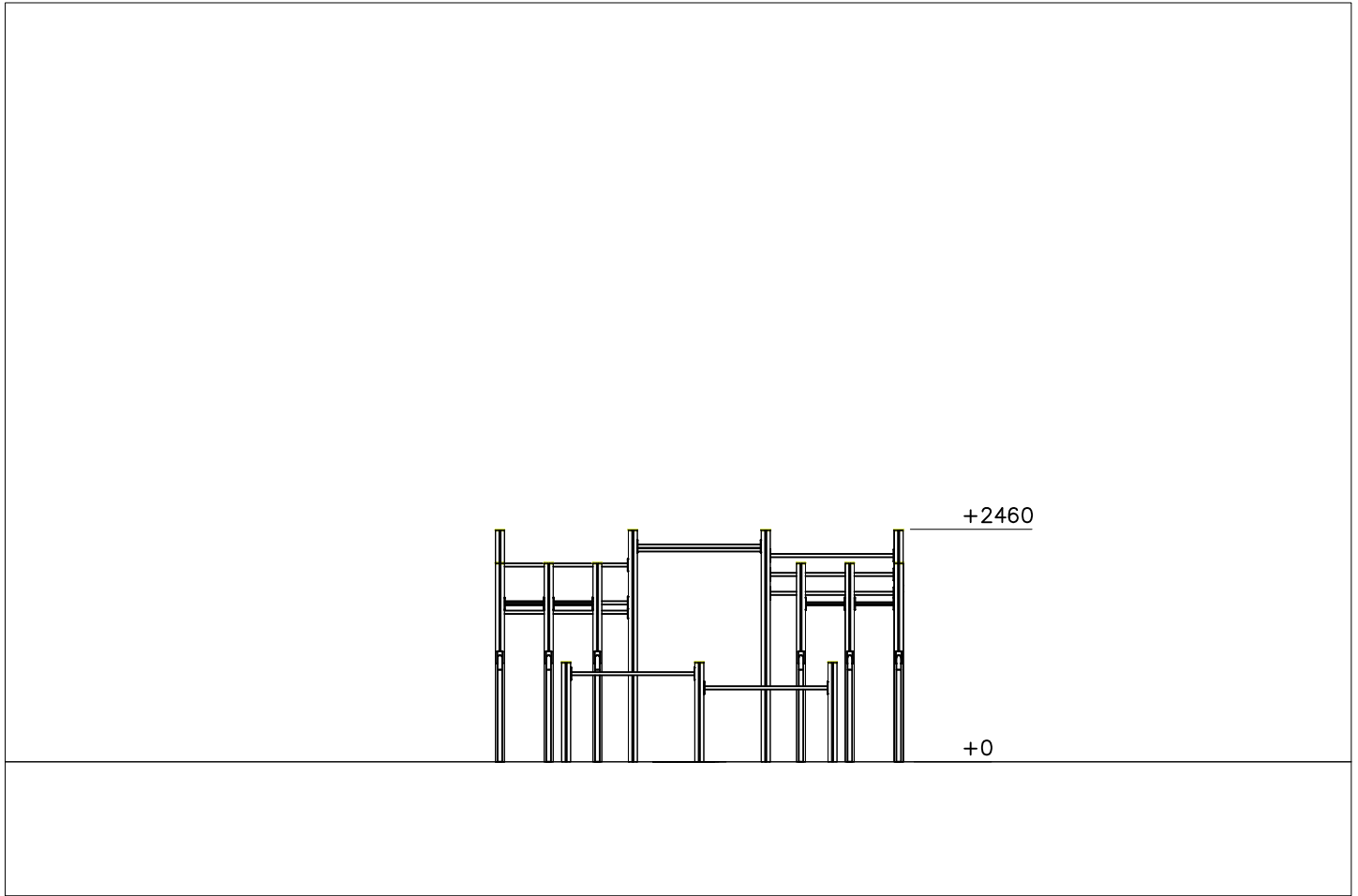

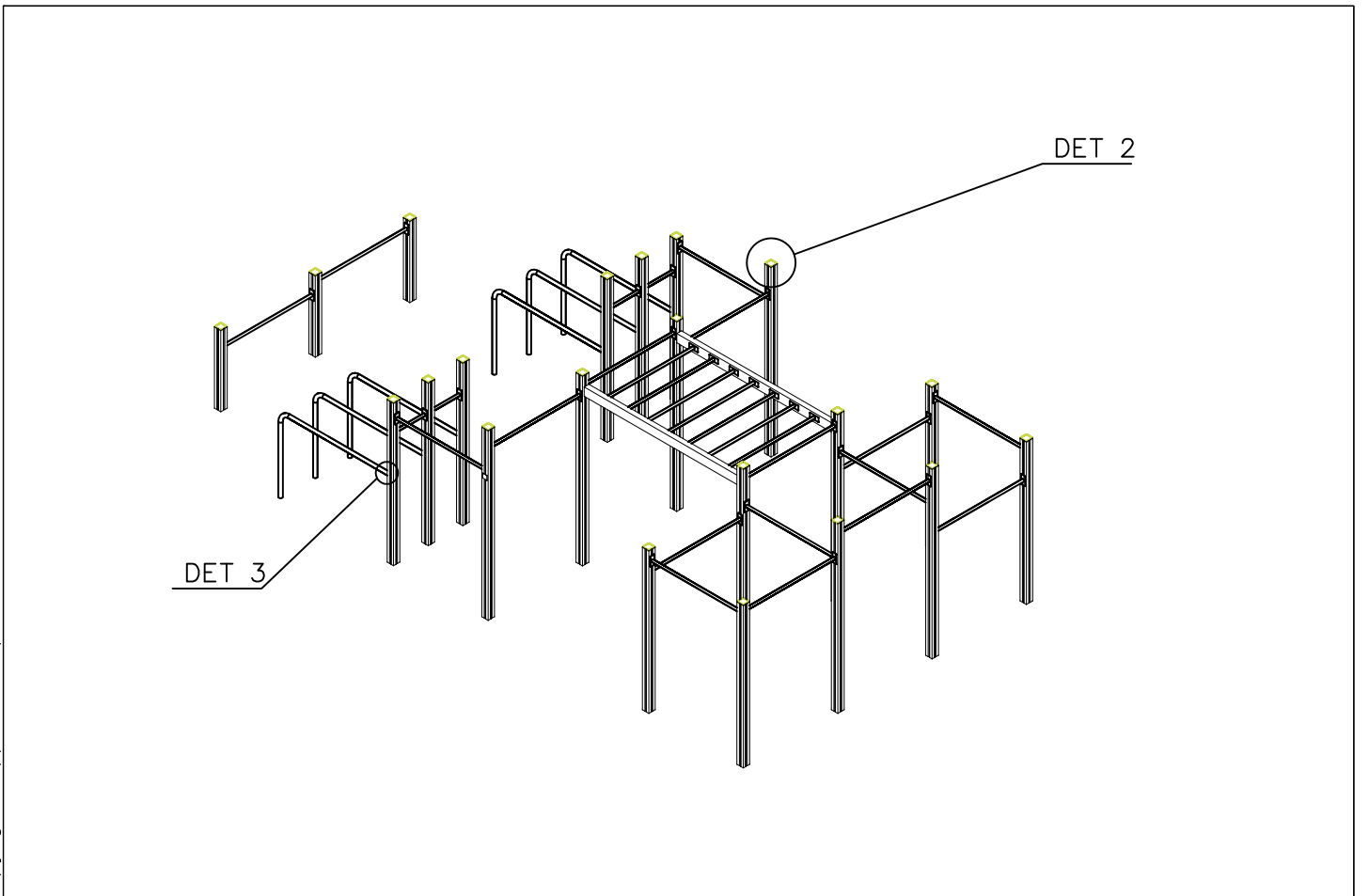
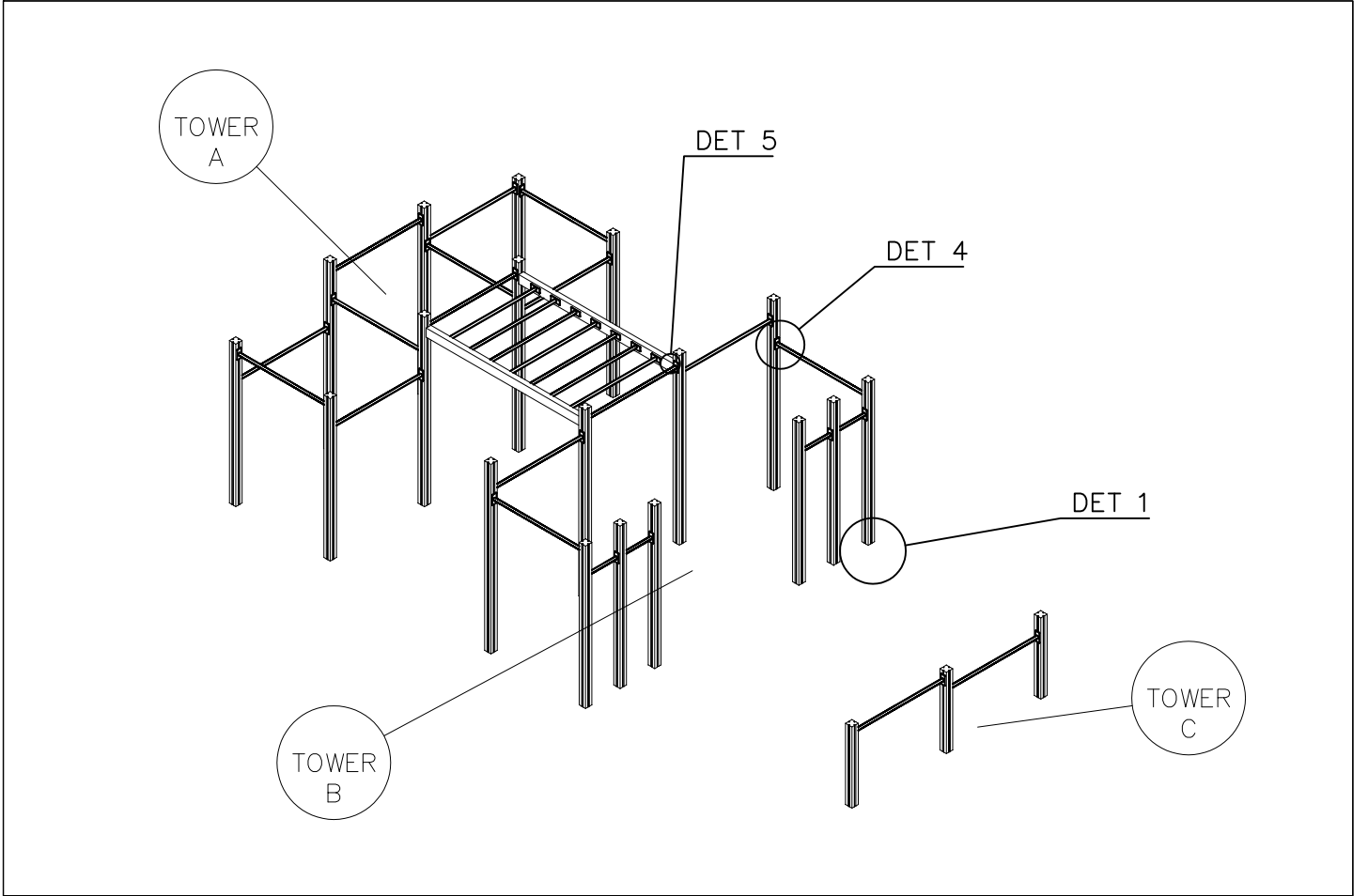

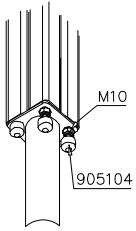
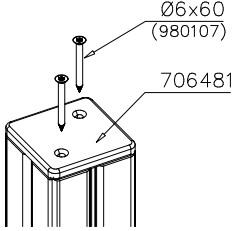
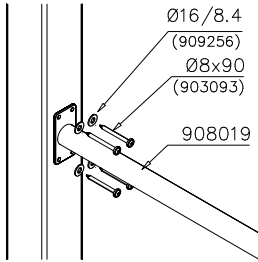
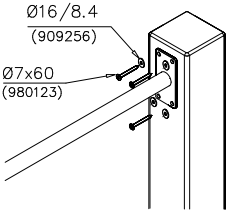
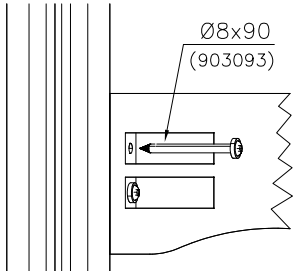
<p>DET 1</p> 	<p>DET 2</p> 	<p>DET 3</p> 	<p>DET 4</p> 
<p>DET 5</p> 			

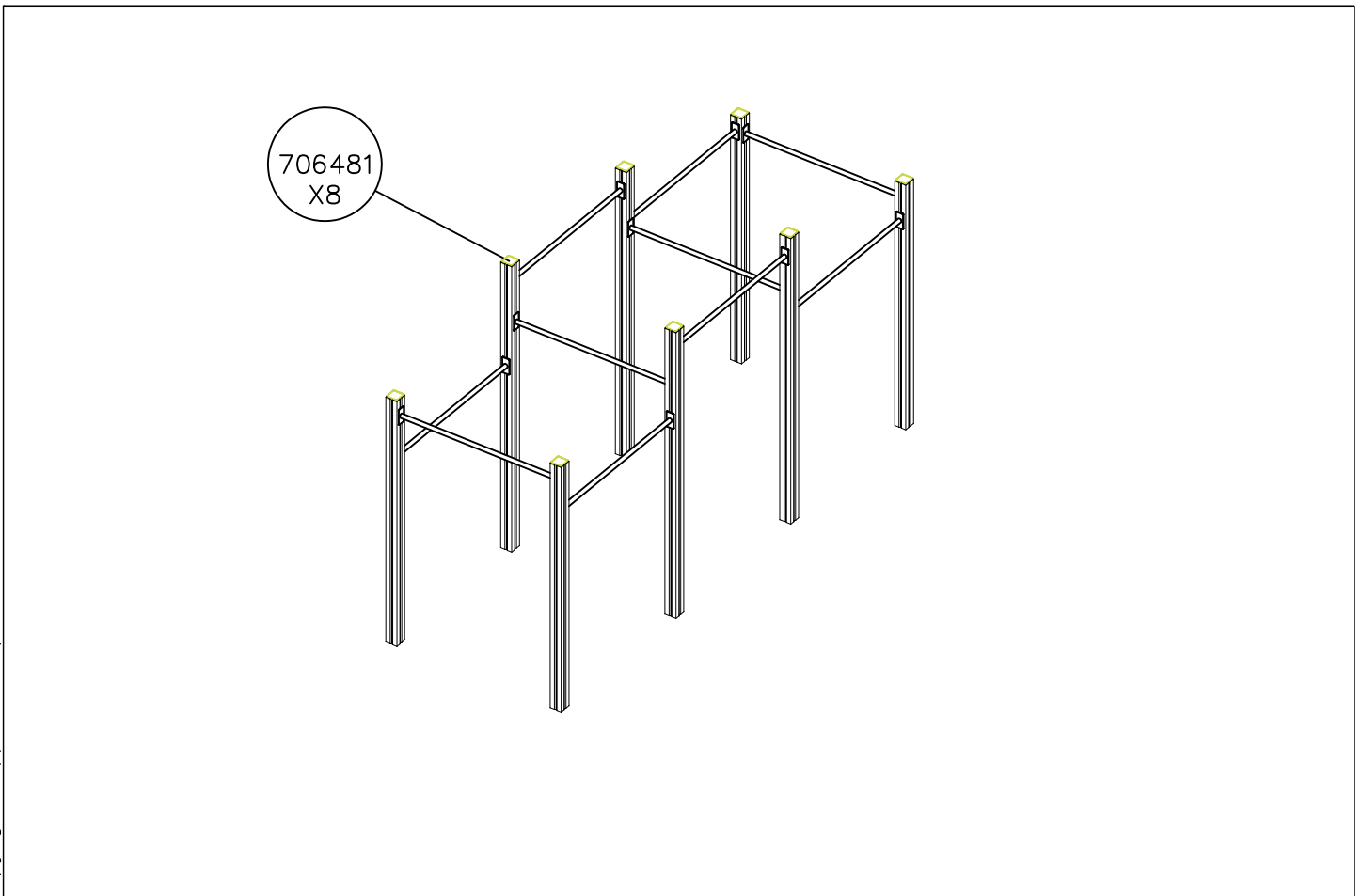
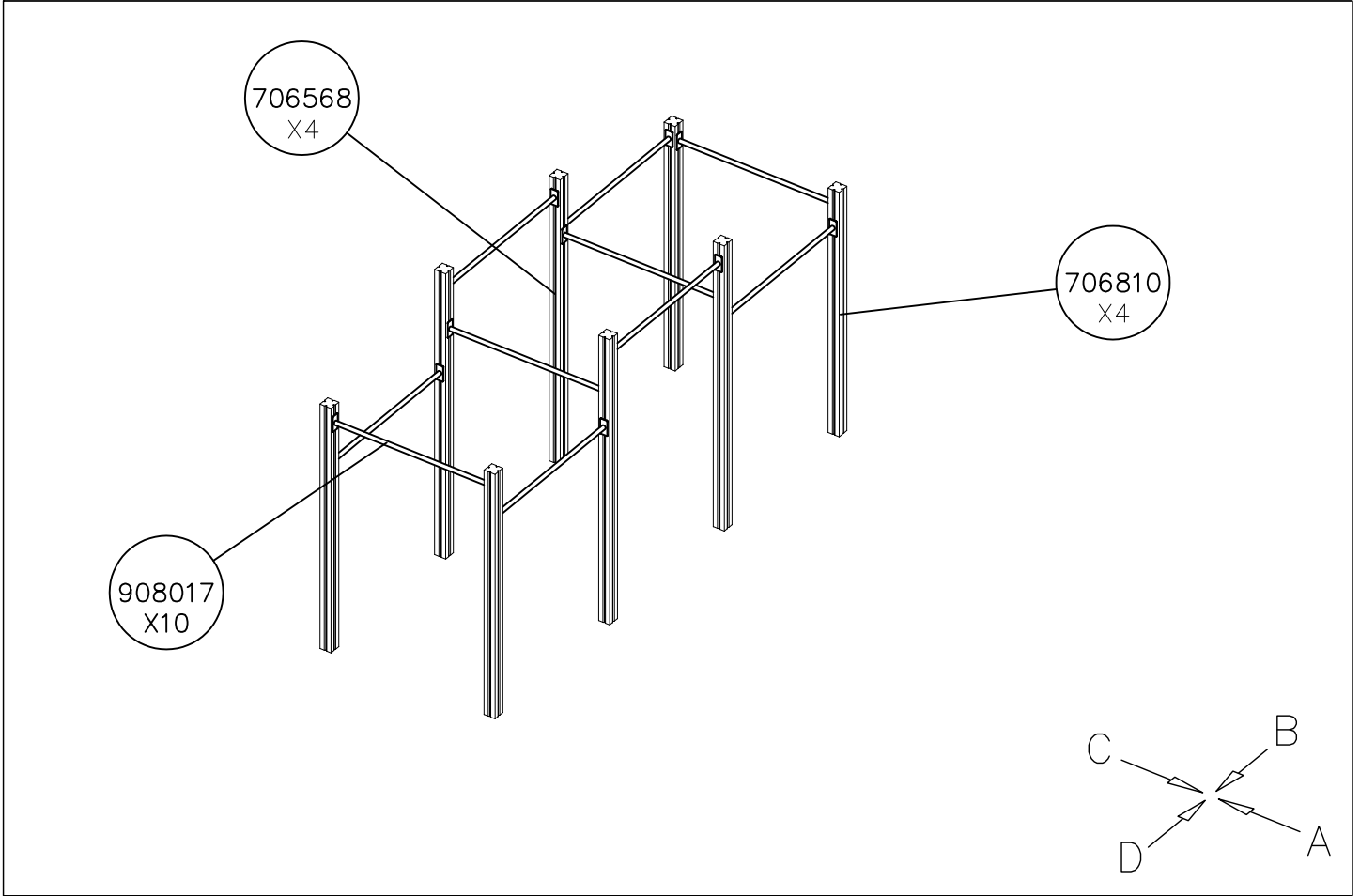

DATE: 11.4.2018

1:50

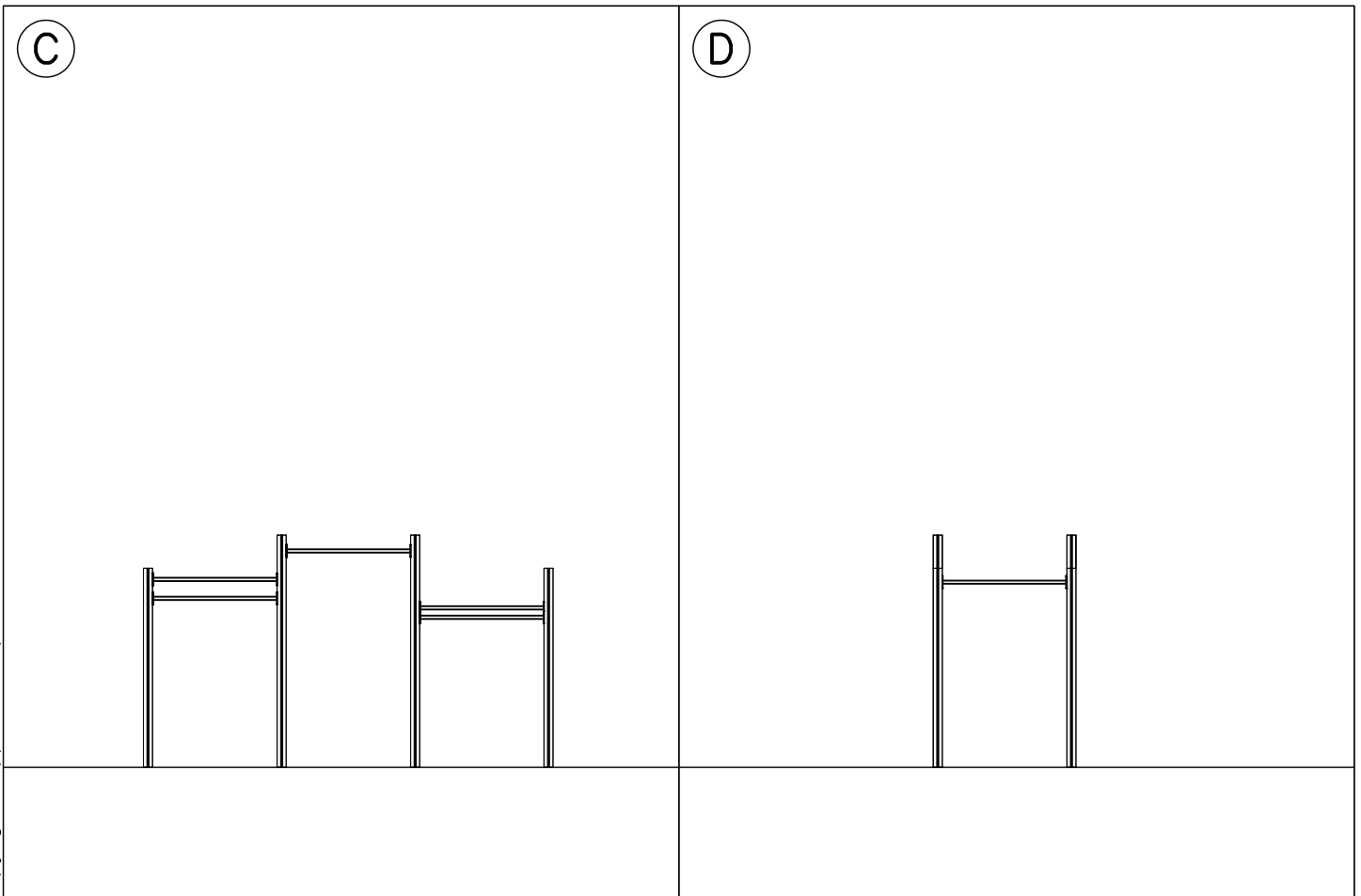
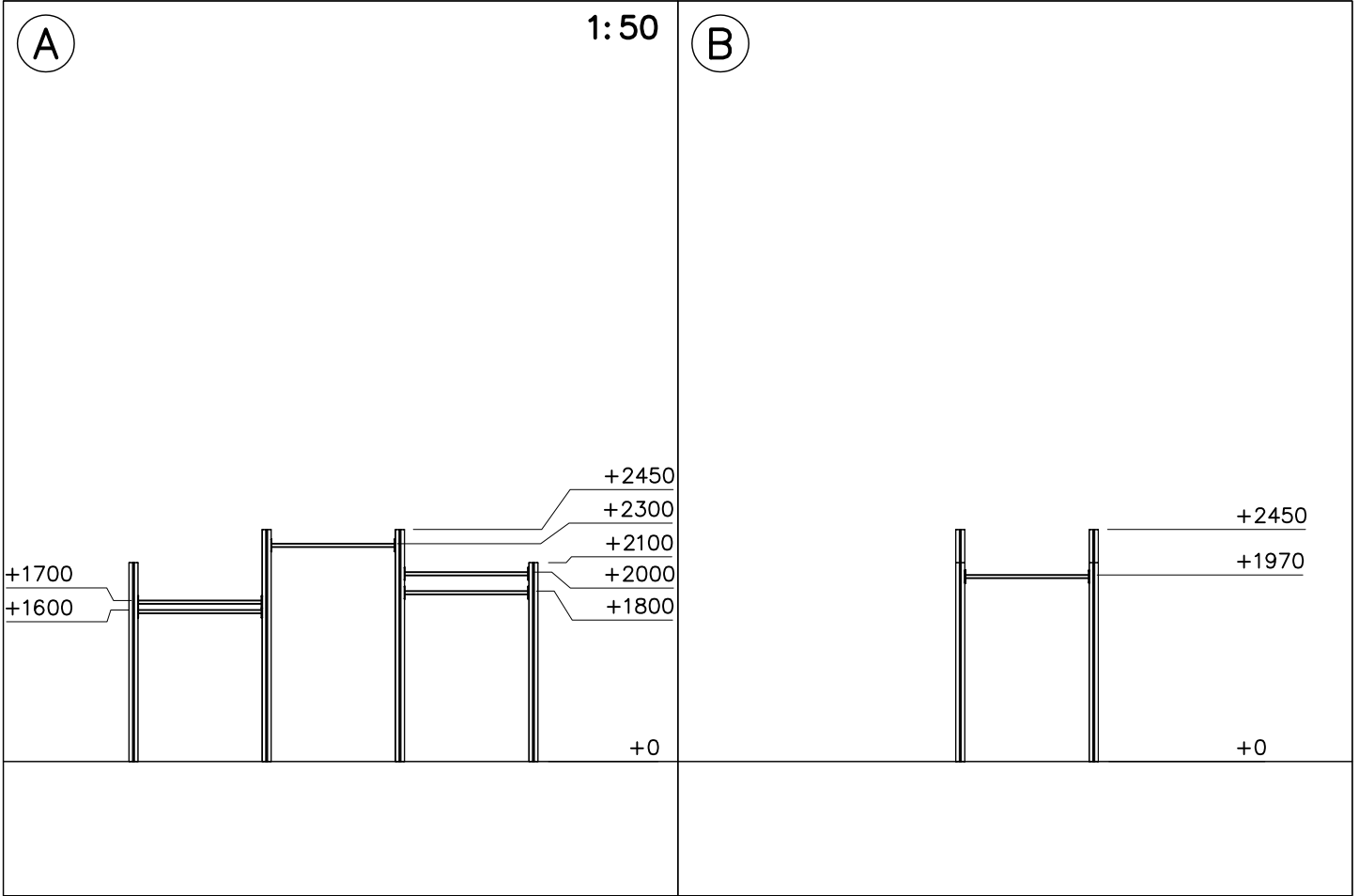

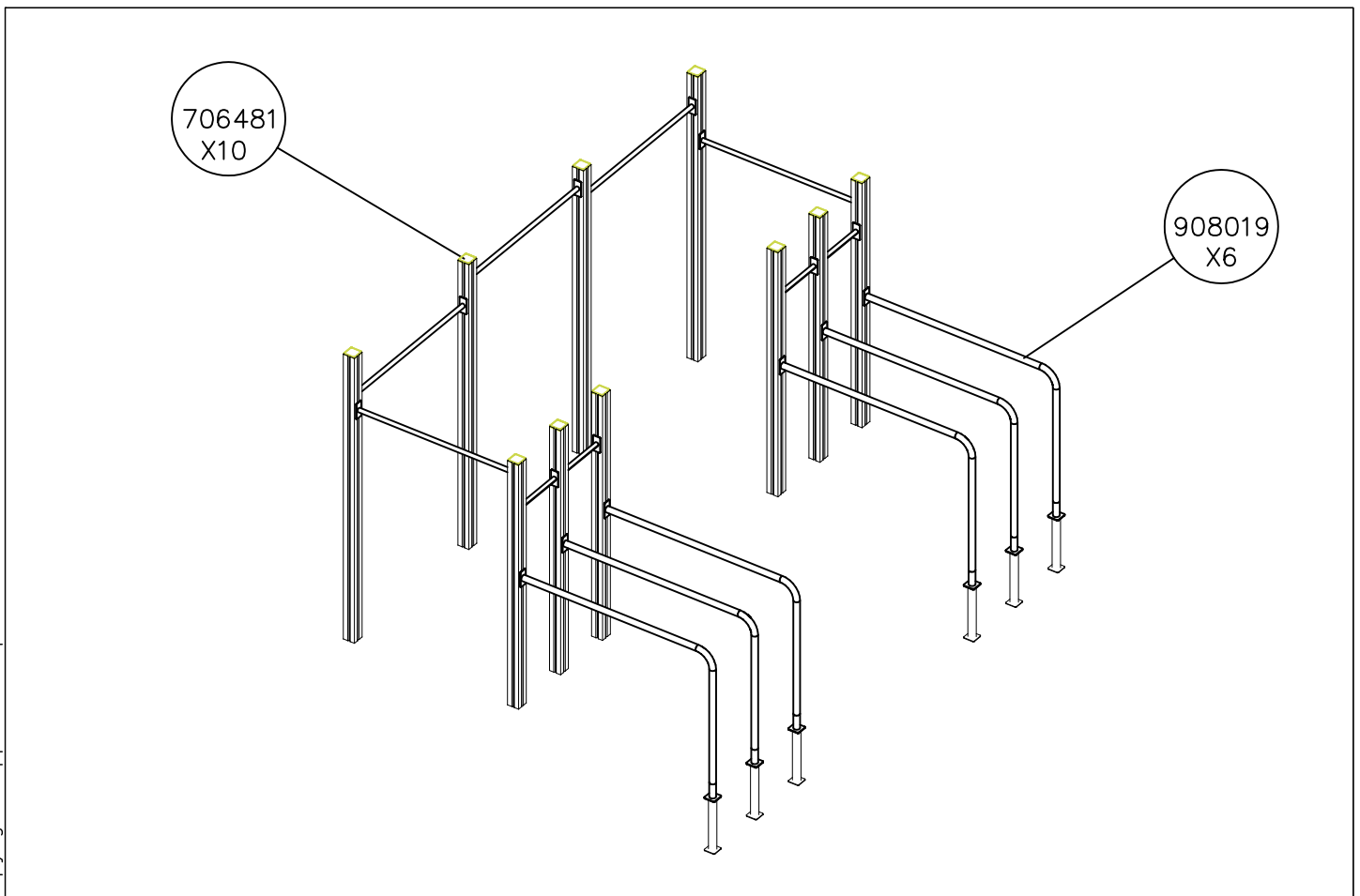
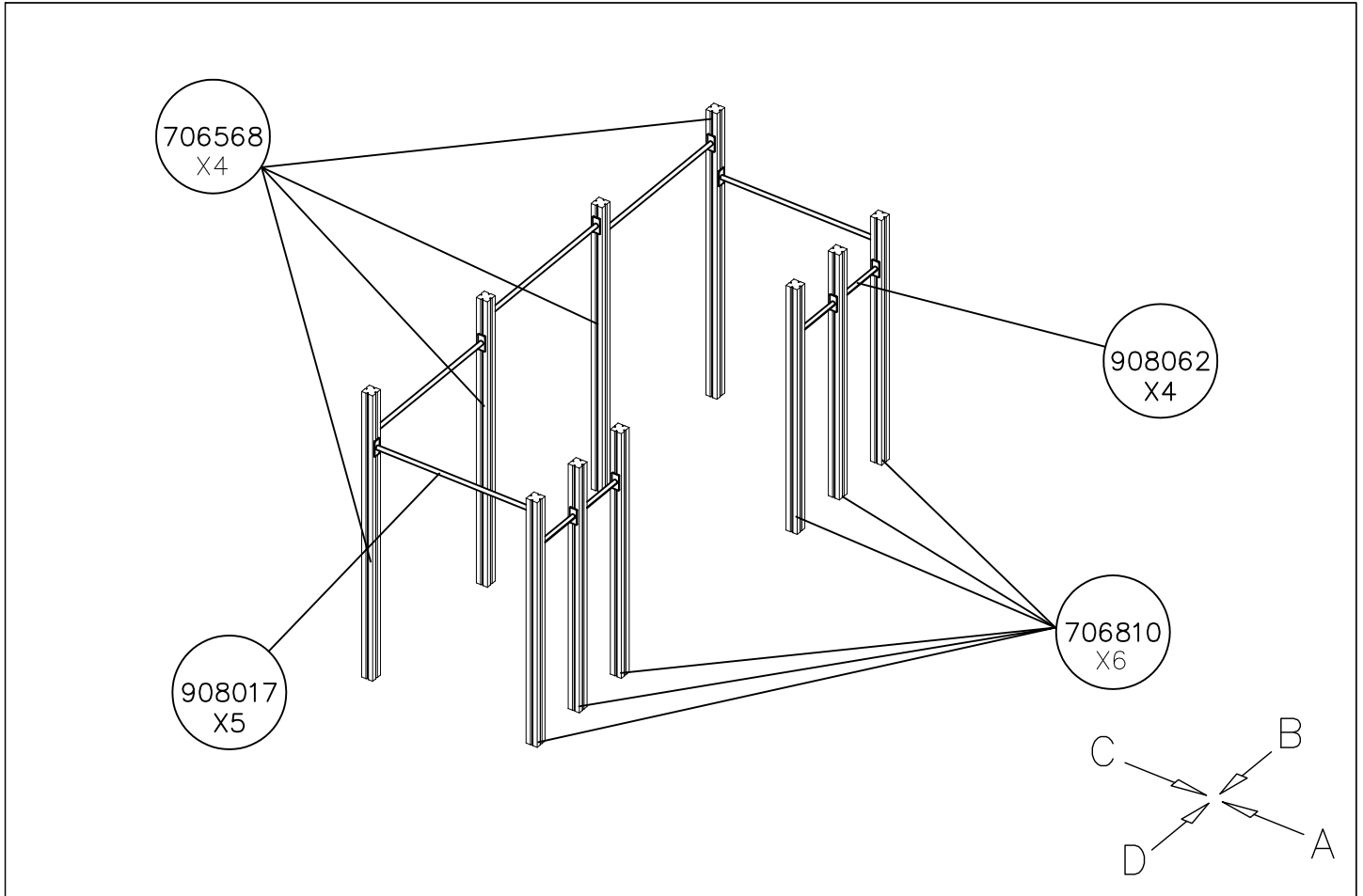

DATE: 11.4.2018

1:50

A

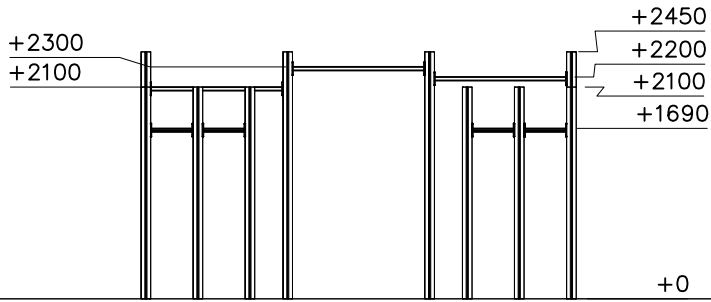

B

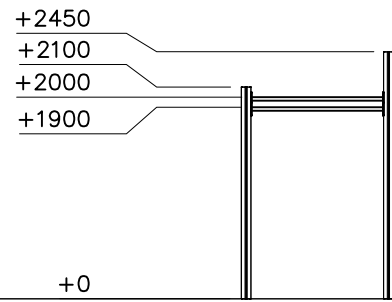

C

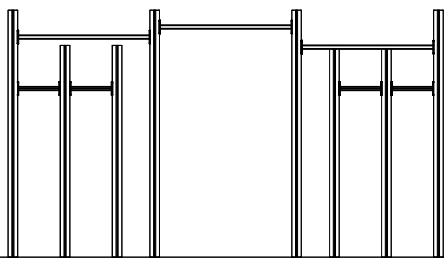

D

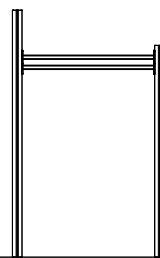

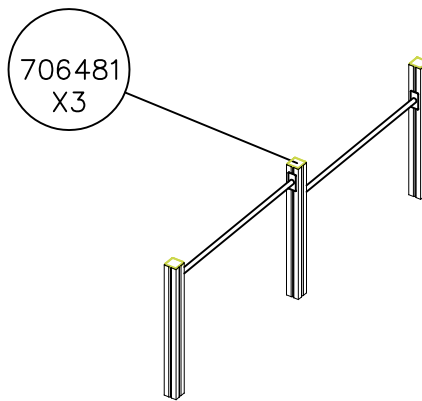
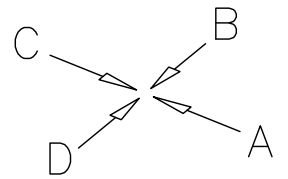
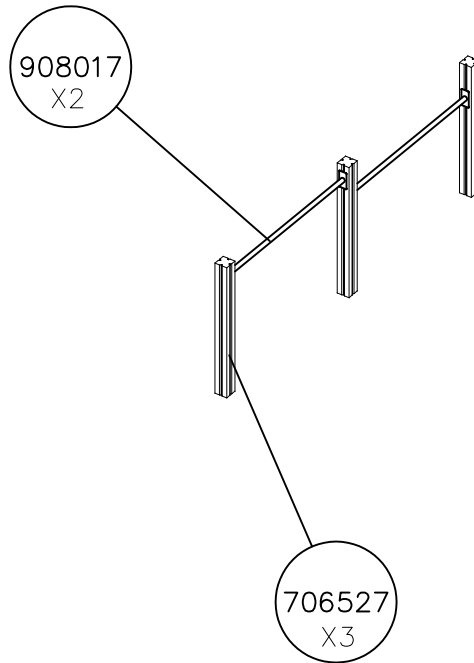

DATE: 11.4.2018

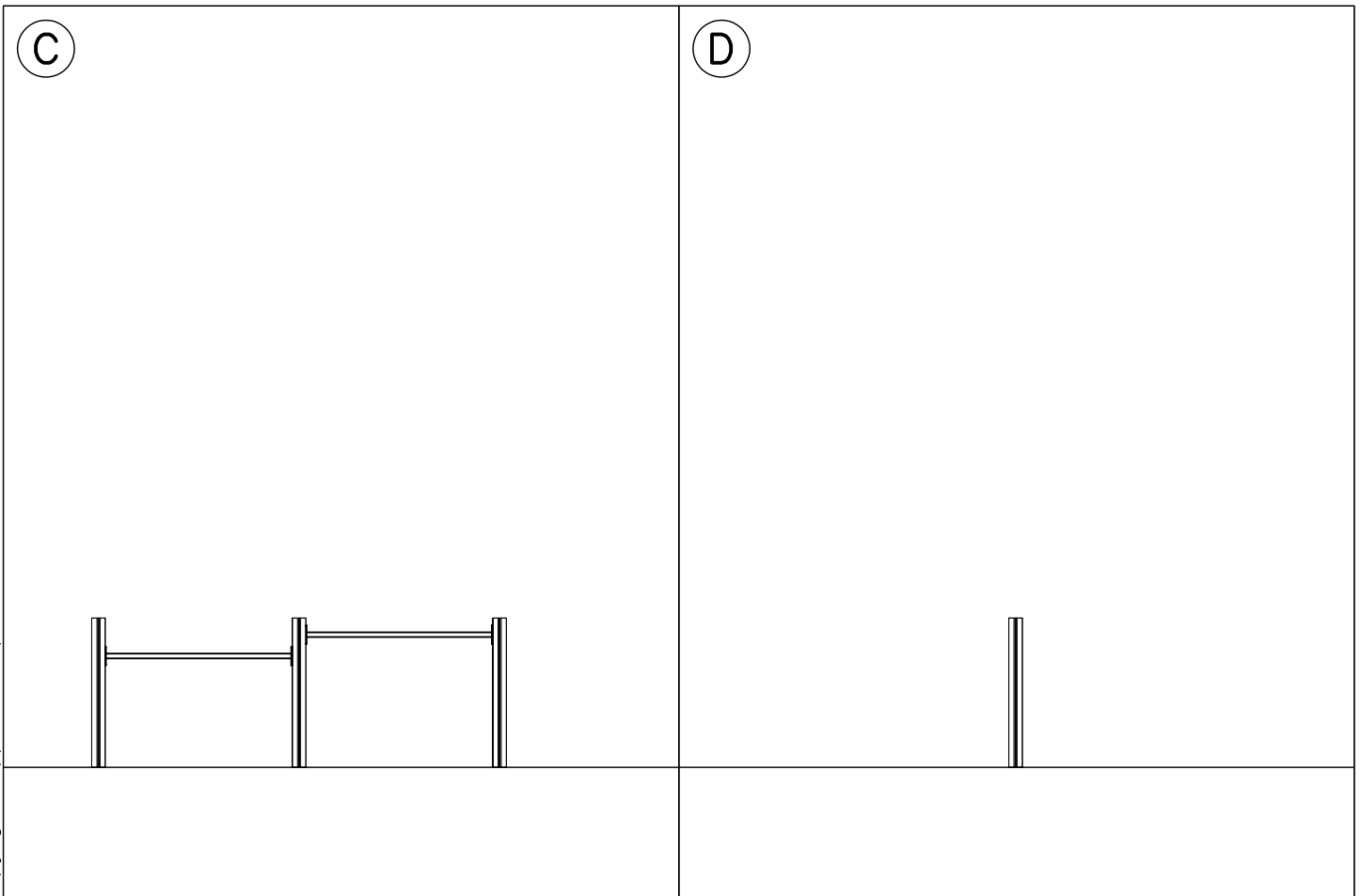
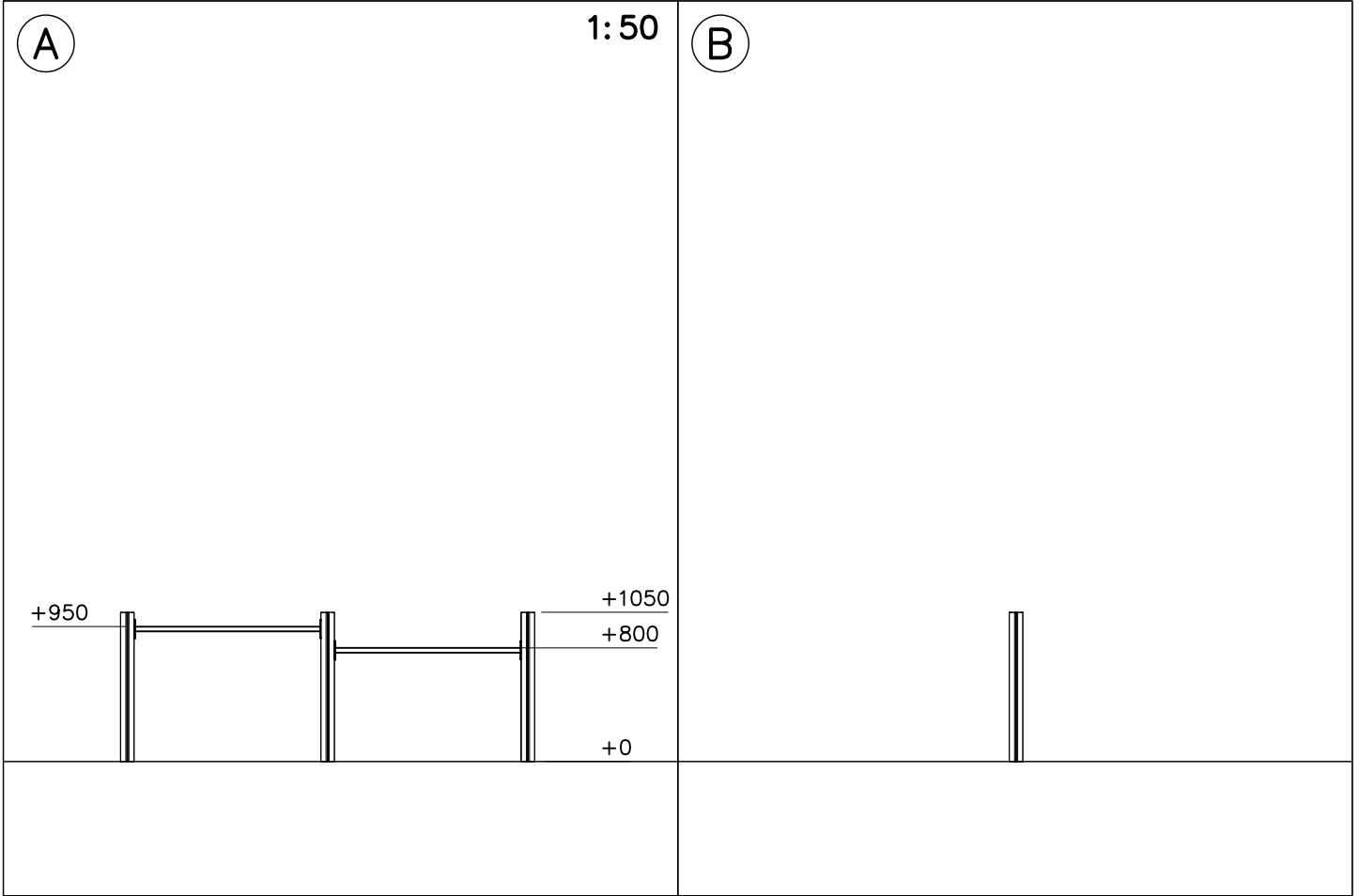

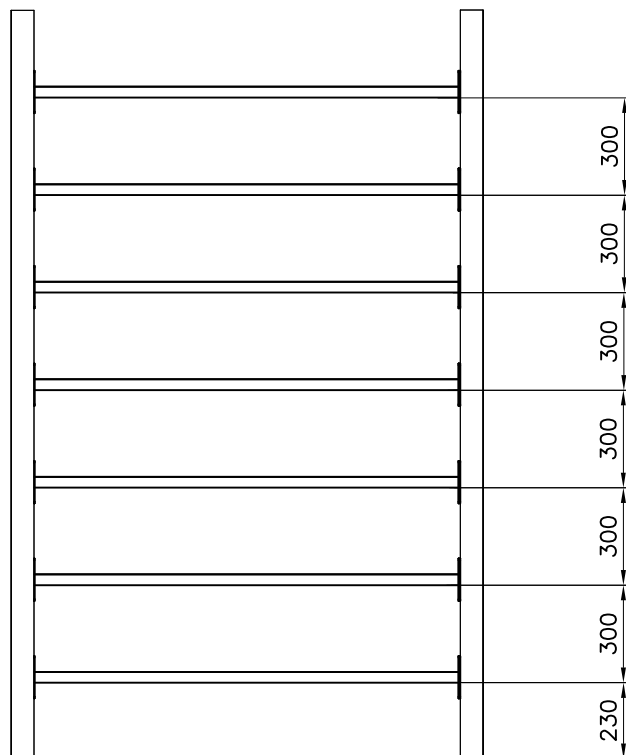
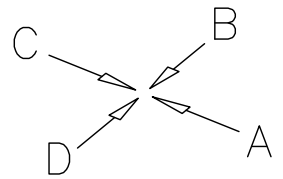
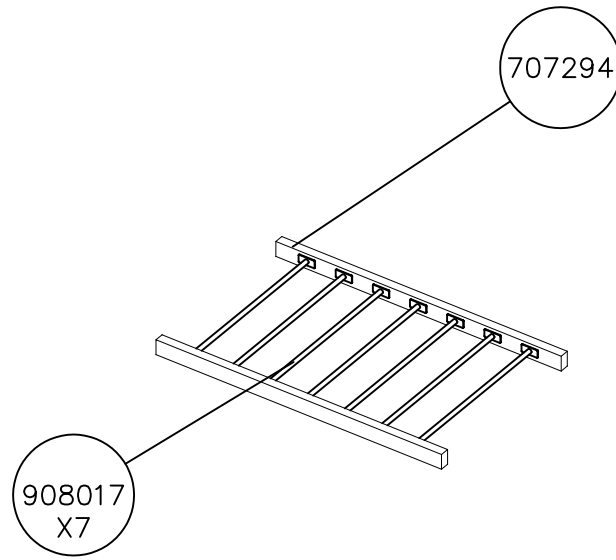

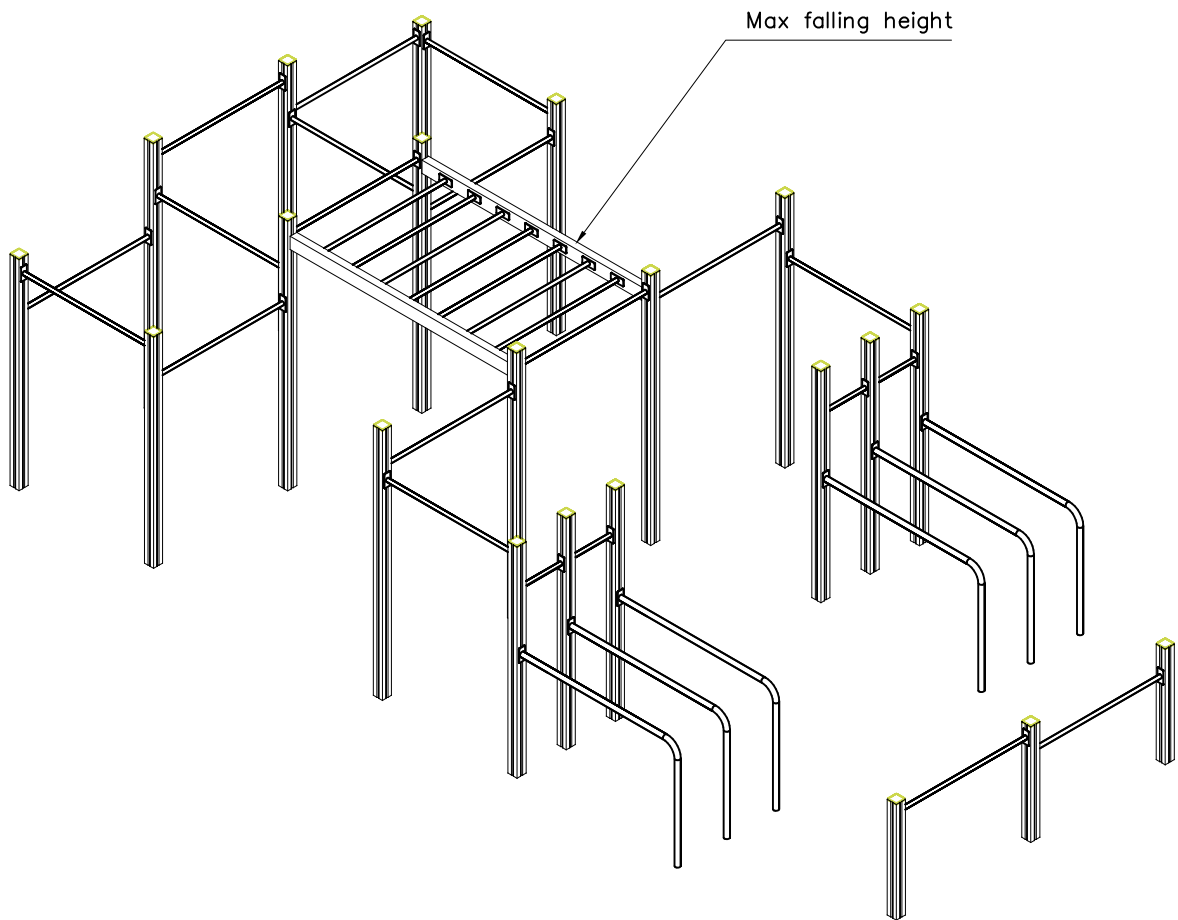



Tuotekyltti tulee tuotteen mukana yhdellä seuraavista tavoista:

1) Metallinen tuotekyltti ja kiinnitysruuvit

- Kiinnitä tuotekyltti ruuveilla tolppaan noin 2 metrin korkeuteen kuvan 1 mukaisesti.

2) Tuotekylttitarra

- Puhdista maalattu metalli- tai vaneripinta pölystä ja kosteudesta. Liimaa tarra kuvan 2 mukaisesti.
- Huom. Älä kiinnitä tarraa karheapintaiseen laminaattiin tai maalattuun puuhun.

Vår produktmärkning levereras på ett av följande sätt:

1) Produktskylt i metall

- Fäst skylten med de medföljande skruvarna

2) Självhäftande produktetikett

- Rengör den pulverlackerade metallytan eller laminatyten så att den blir fri från smuts och fukt. Fäst etiketten enligt fig. 2.
- Obs! Fäst ej etiketten på detaljer med skrovlig yta eller på målat trä.

Product label is delivered by one of following ways:

1) Metal product label and screws

- Fasten the label with screws.

2) Label sticker

- Clean the painted metal or plywood surface from dirt and moisture. Fasten the sticker as shown in the figure 2.
- Note. Do not attach the sticker to rough surfaced laminate or painted wood.

La plaque d'informations produit est livrée sous l'une de ces 3 formes :

1) Plaque métallique et vis

- Fixez la plaque à l'aide des vis.

2) Etiquette autocollante

- Avant de coller l'étiquette, nettoyez le composant métallique peint ou la plaque de contreplaqué, de toute saleté. La surface doit être sèche (voir image 2).
- Attention, ne pas coller l'étiquette sur une surface lamellé-collée irrégulière ou sur du bois peint.

Die Auslieferung des Produktaufklebers erfolgt auf eine dieser Arten:

1) Produkt-Schild aus Metall incl. Schrauben

- Die Befestigung des Schildes erfolgt mittels der Schrauben.

2) Aufkleber

- Entfernen Sie zunächst Schmutz und Feuchtigkeit vom lackierten Metall bzw. von der Holzoberfläche und bringen Sie den Aufkleber wie im Bild oben rechts beschrieben auf den gesäuberten Untergrund auf.
- Beachten Sie: Bringen Sie den Aufkleber nicht auf raues laminiertes oder lackiertes Holz an.